

Montageanleitung

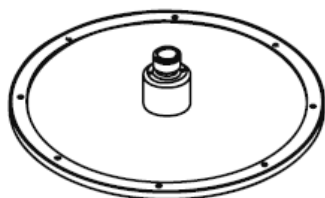

27418XXX



Raindance Royale AIR
28420000

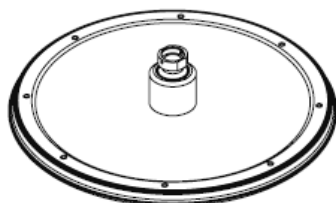

Raindance Royale Classic AIR
28435XXX

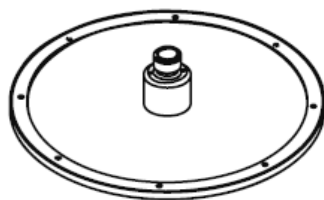

**Raindance Royale
High Flow Set**
27070000

hangrohe

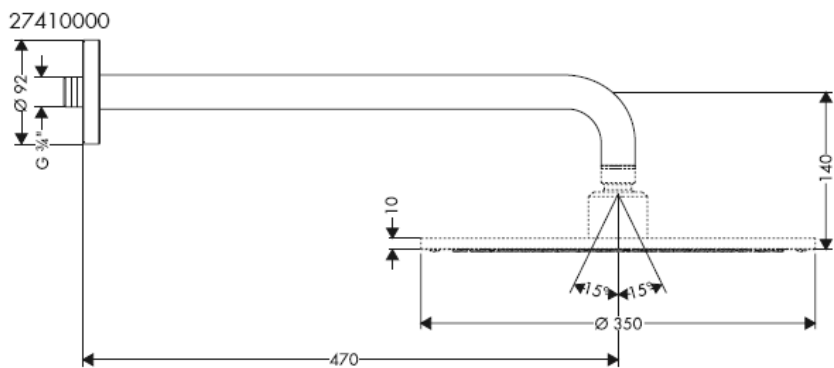
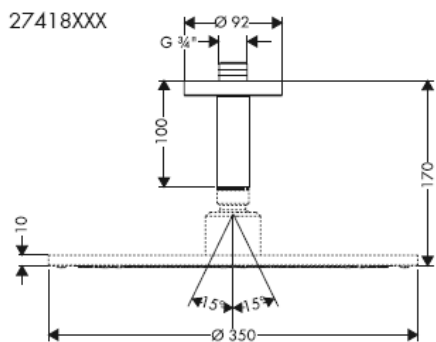
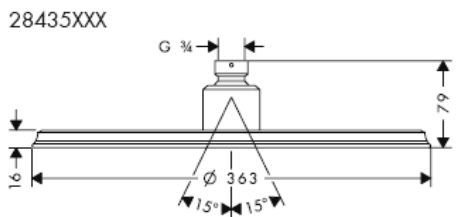
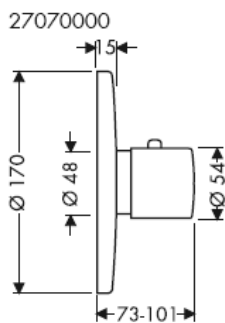
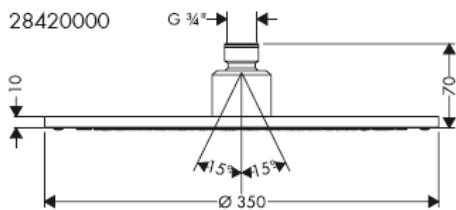

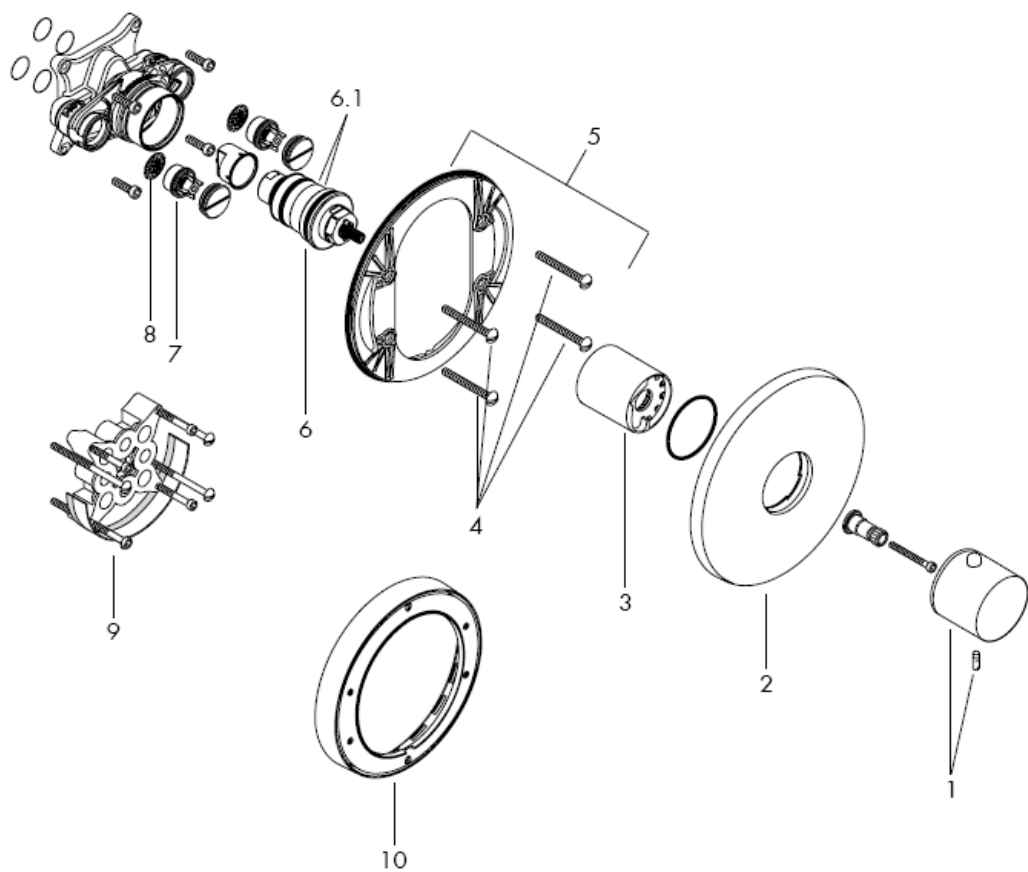

Maße möglichst dem Fliesenraster anpassen.

Wandverstärkung für Brausearmbefestigung notwendig

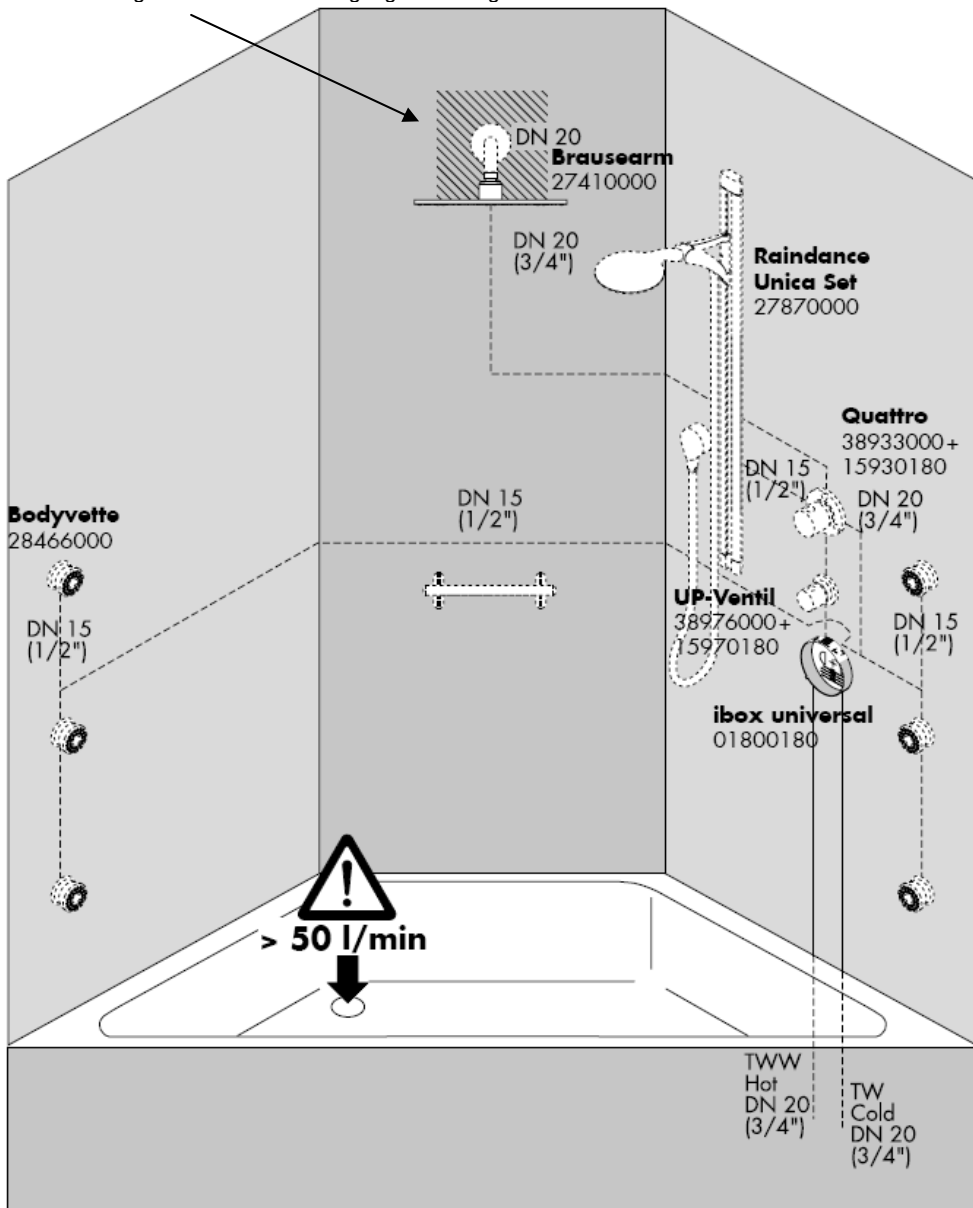

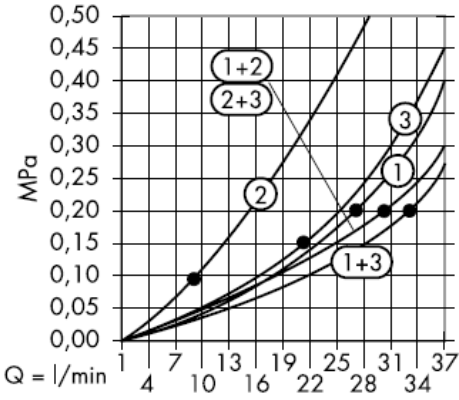

Ab • ist die Funktion gewährleistet.

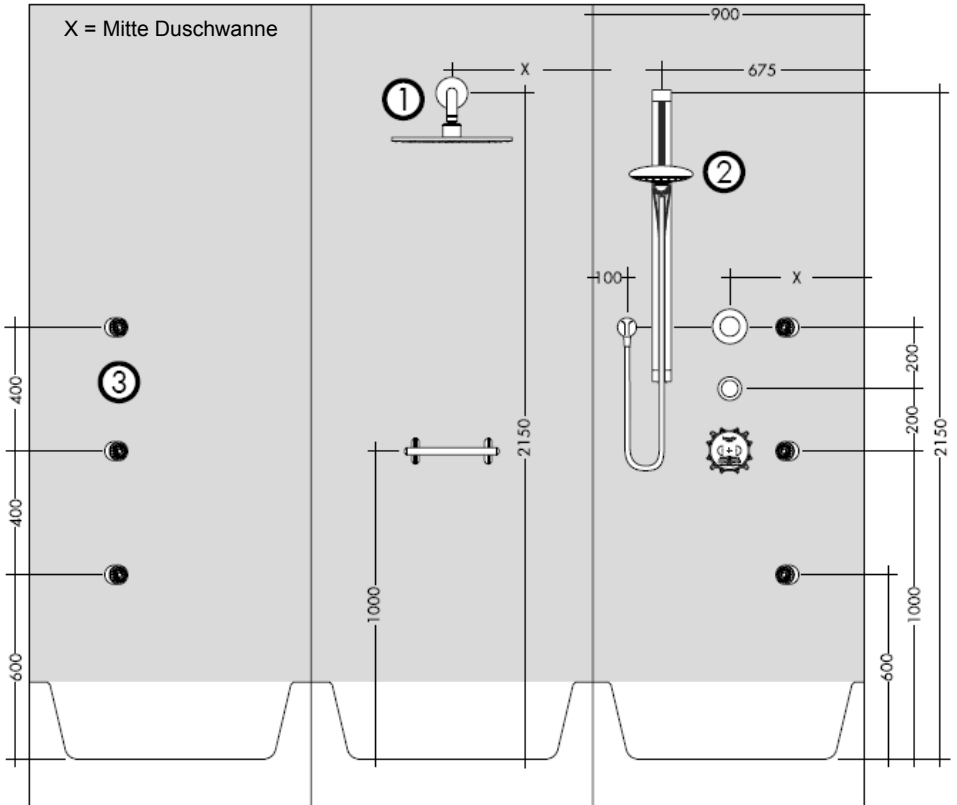

Wandverstärkung für Brausearmbefestigung notwendig

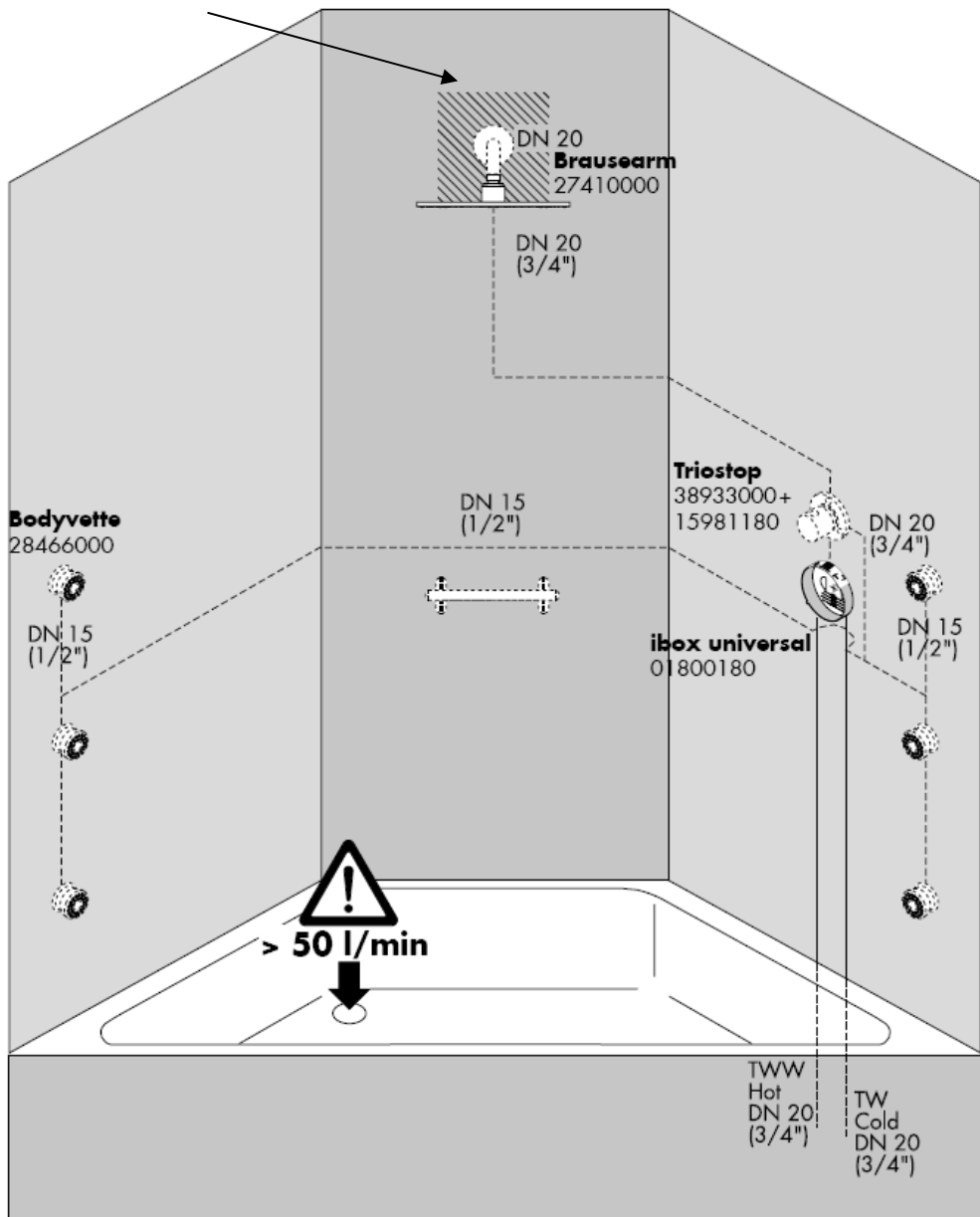

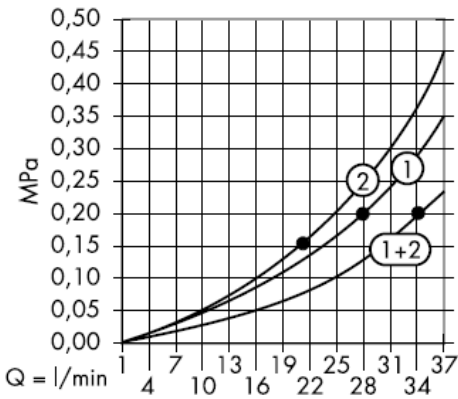

Ab • ist die Funktion gewährleistet.

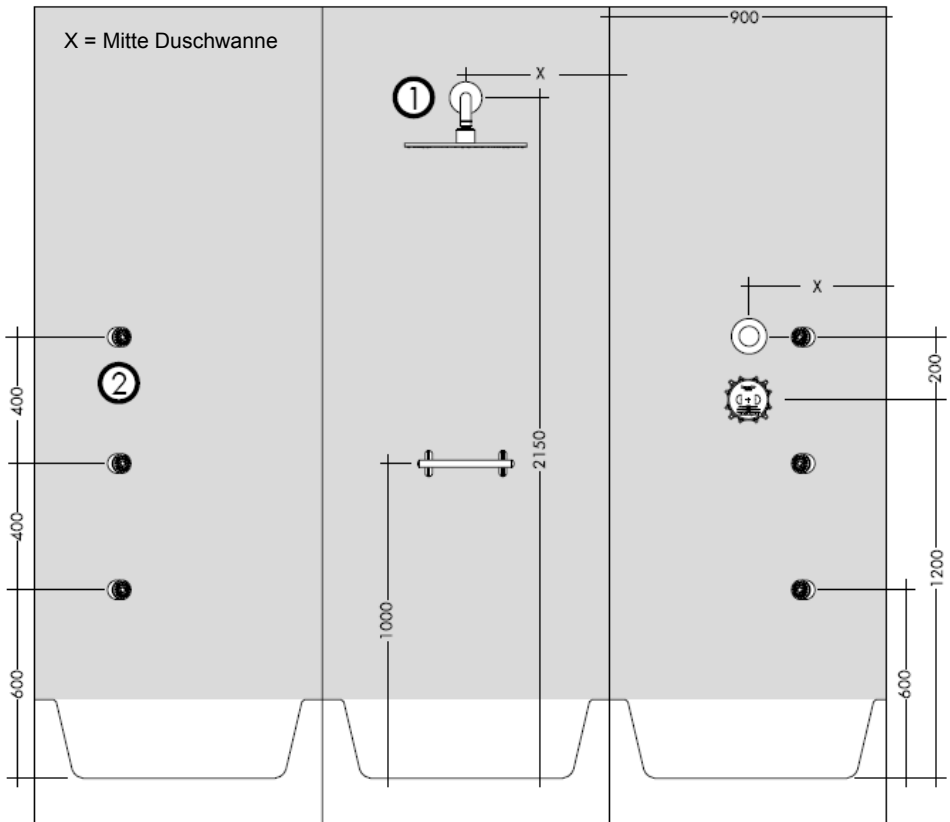

Wandverstärkung für Brausearmbefestigung notwendig

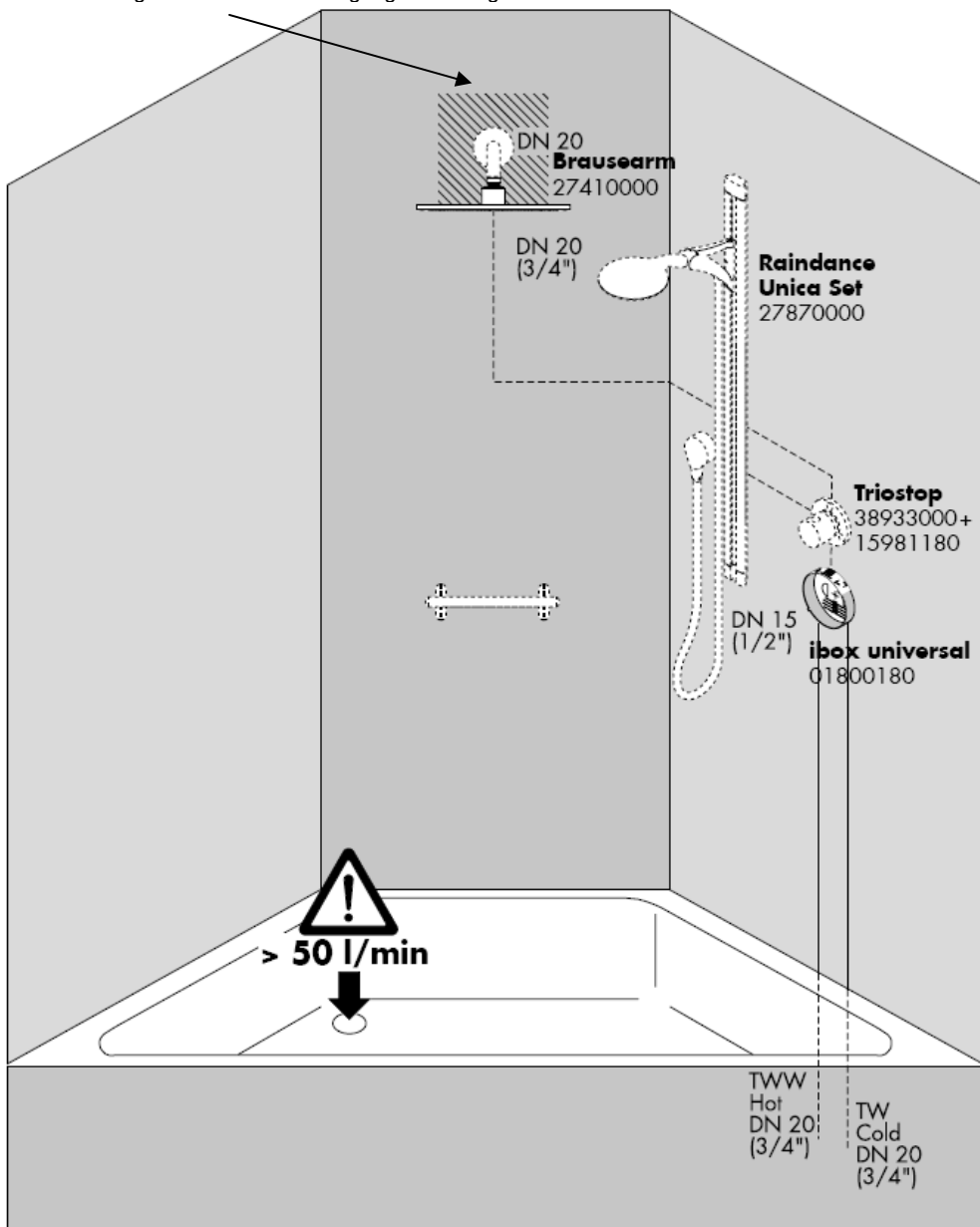

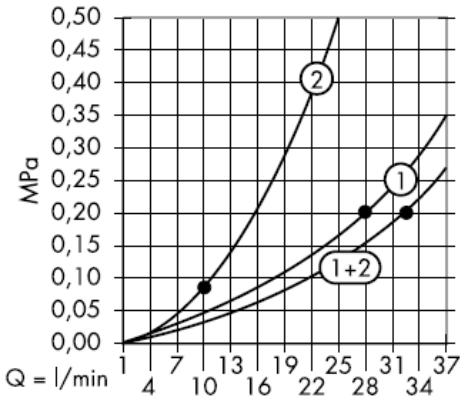

Ab • ist die Funktion gewährleistet.

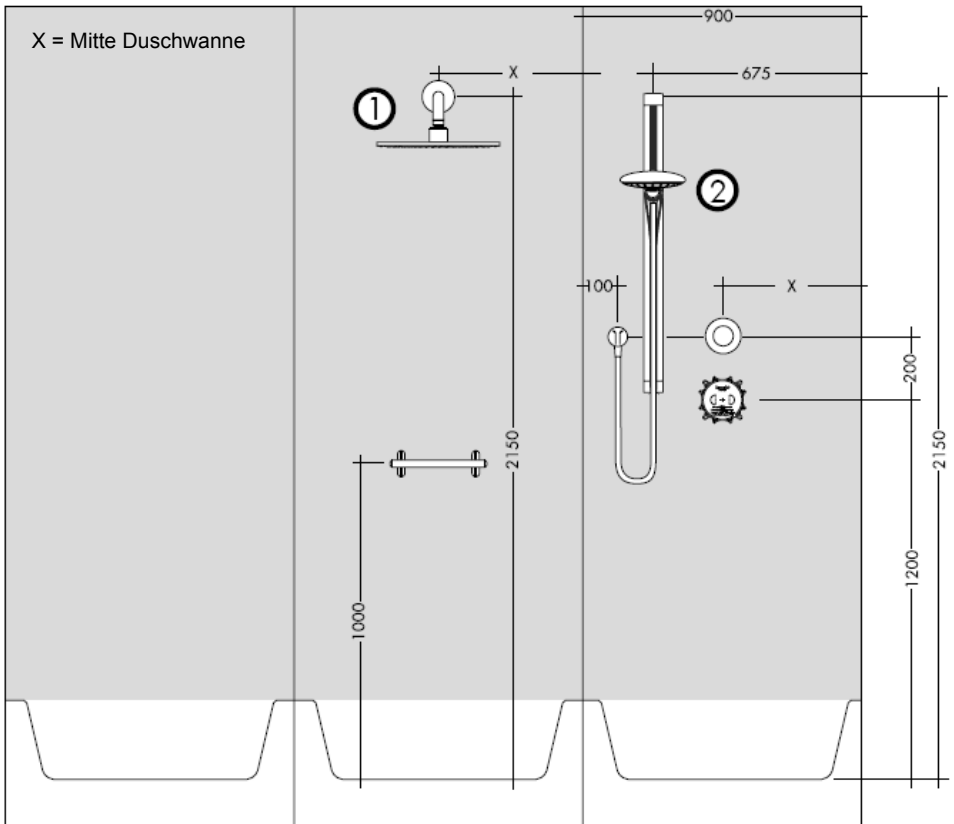

Wandverstärkung für Brausearmbefestigung notwendig

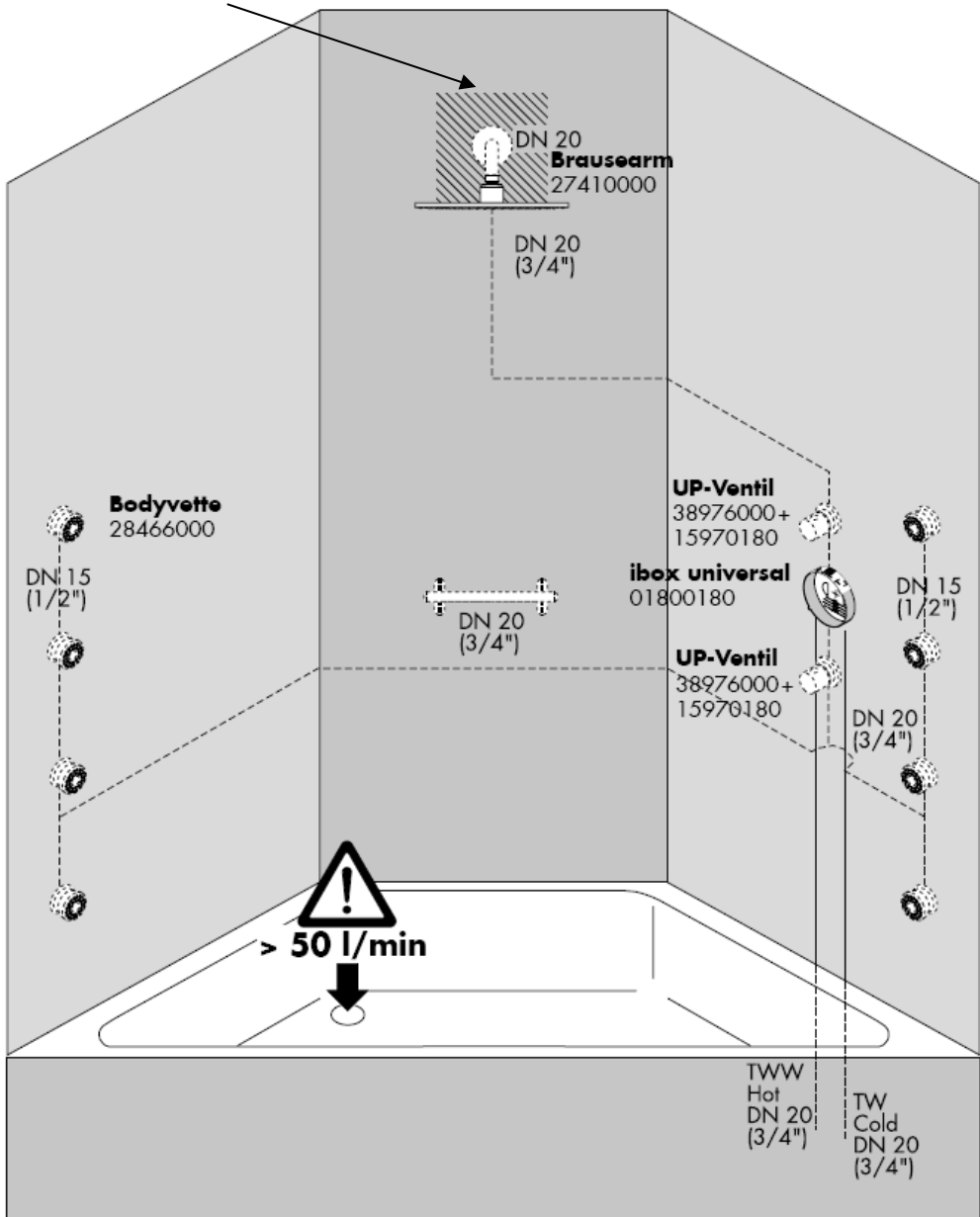

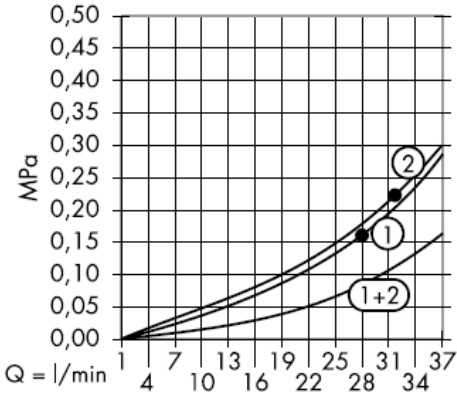

Ab • ist die Funktion gewährleistet.

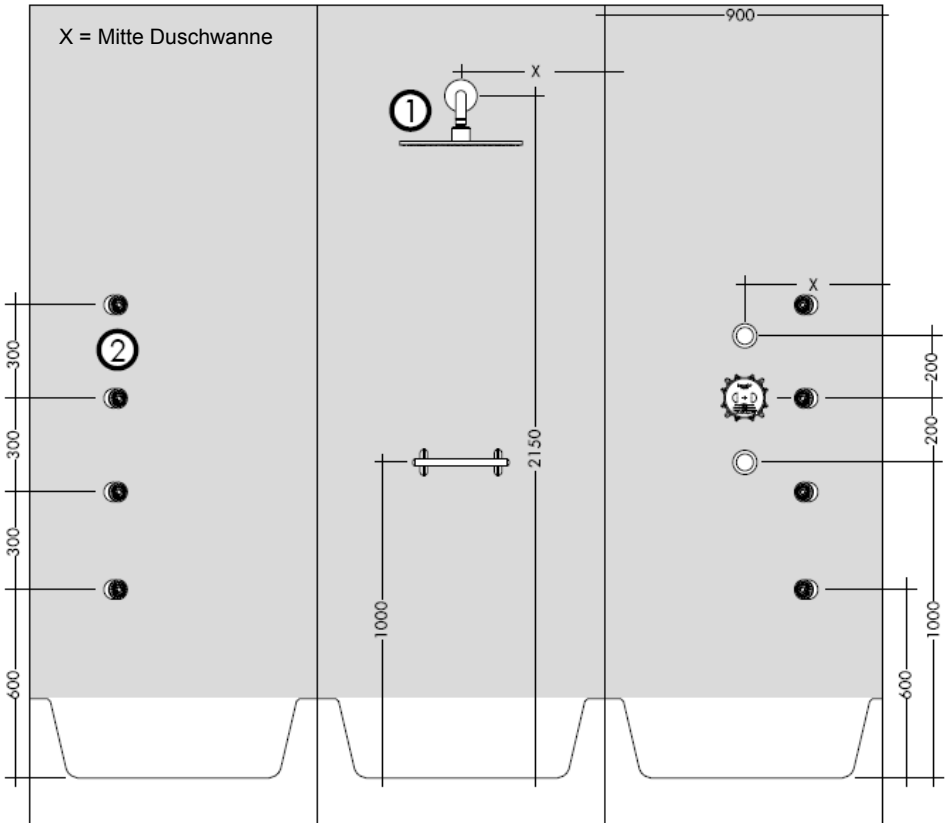

Wandverstärkung für Brausearmbefestigung notwendig

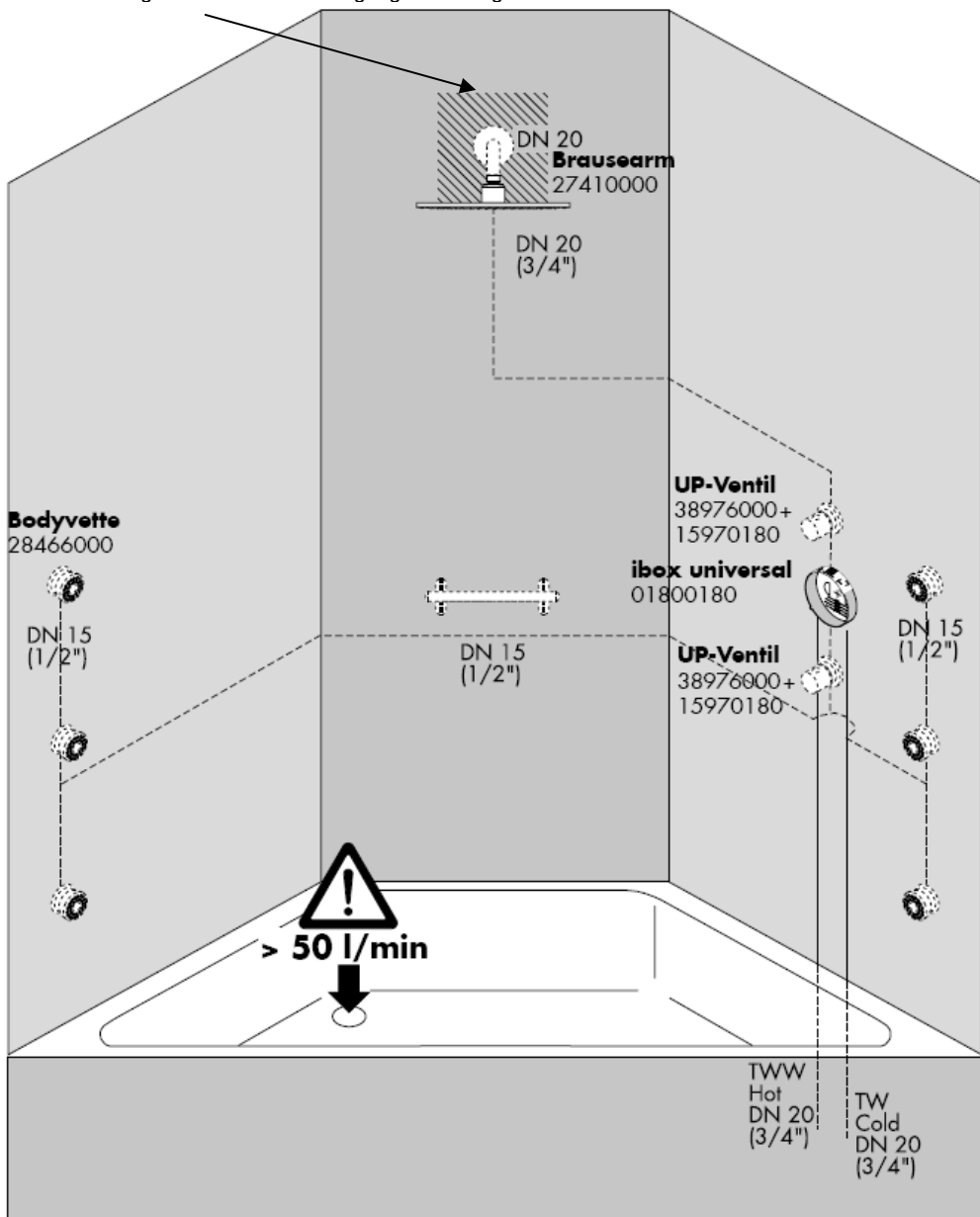

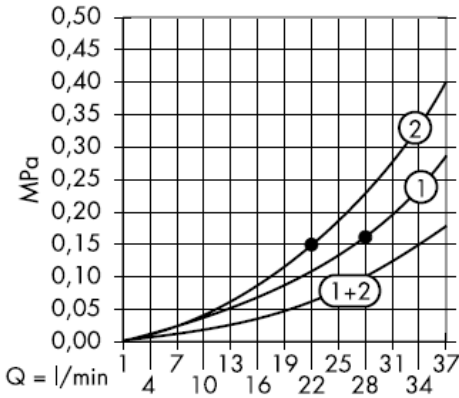

Ab • ist die Funktion gewährleistet.

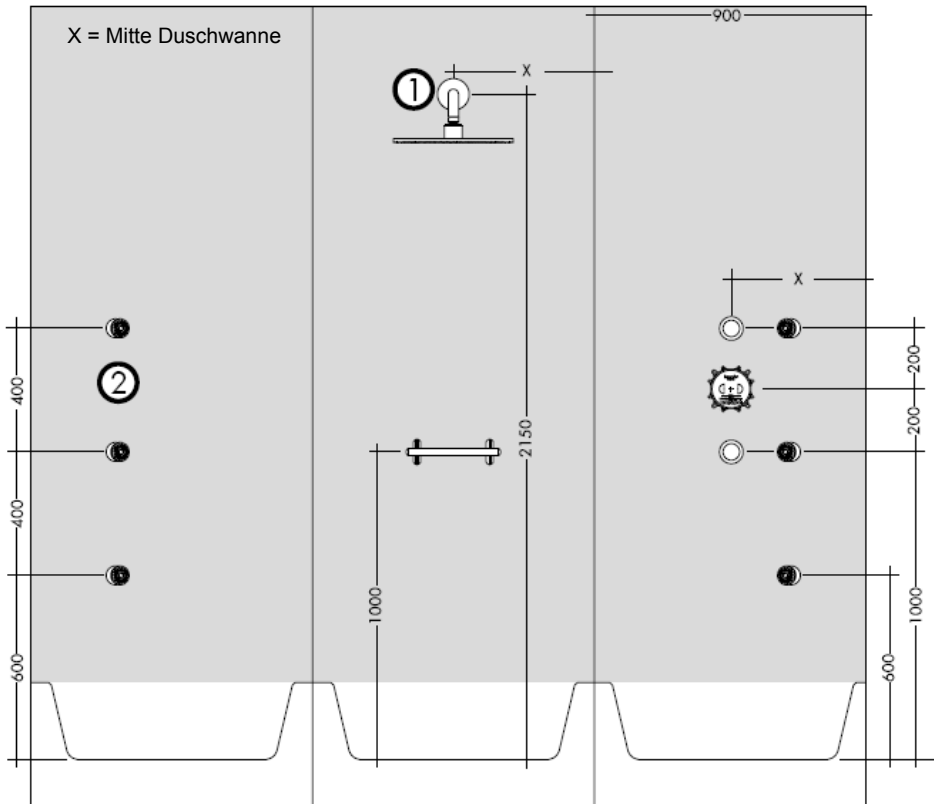

Wandverstärkung für Brausearmbefestigung notwendig

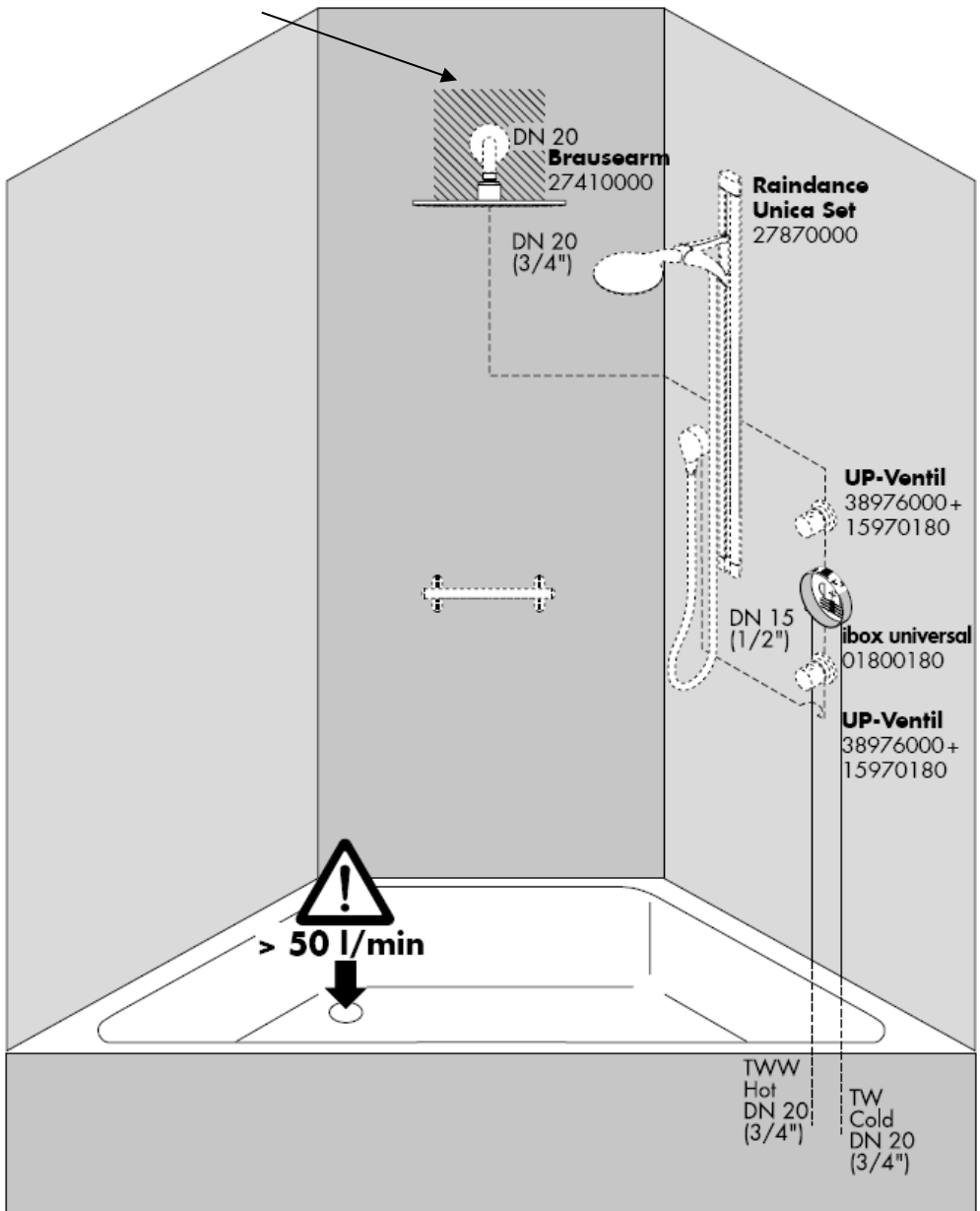

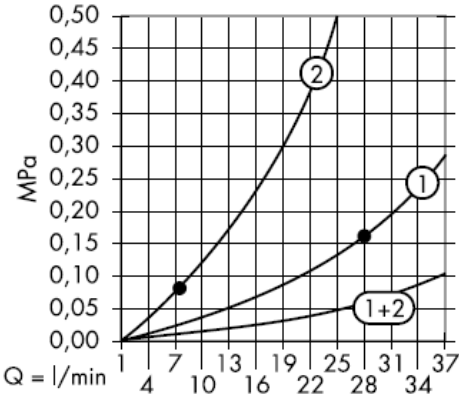

Ab • ist die Funktion gewährleistet.

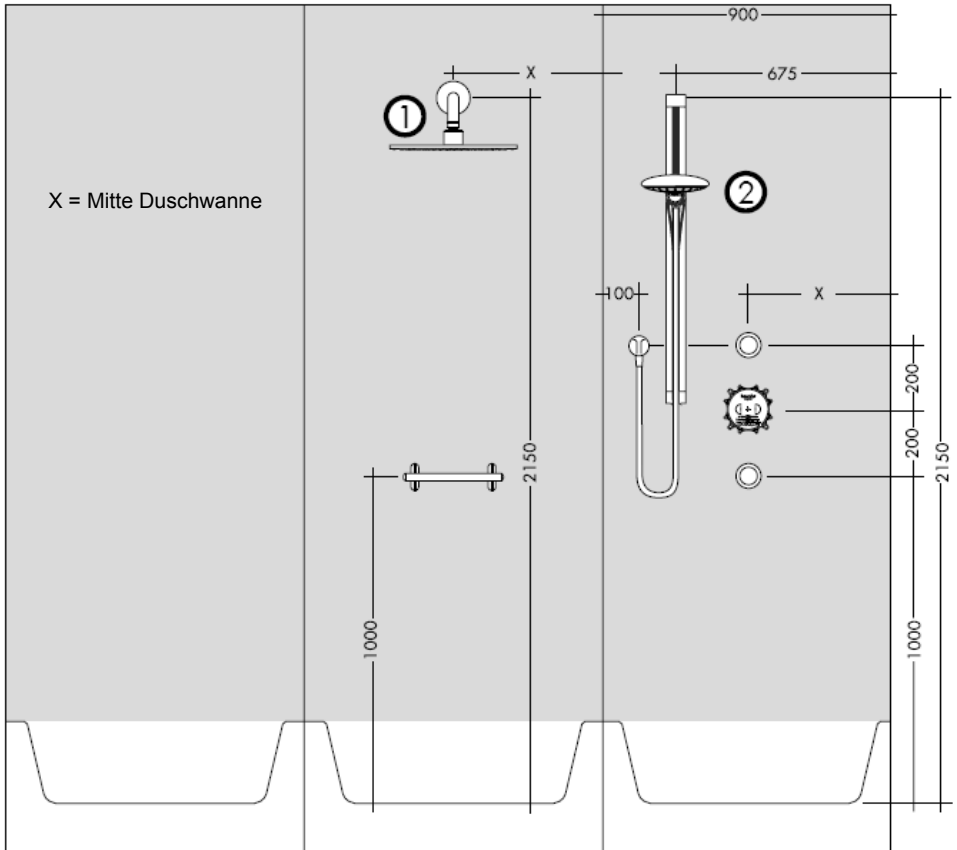

Wandverstärkung für Brausearmbefestigung notwendig

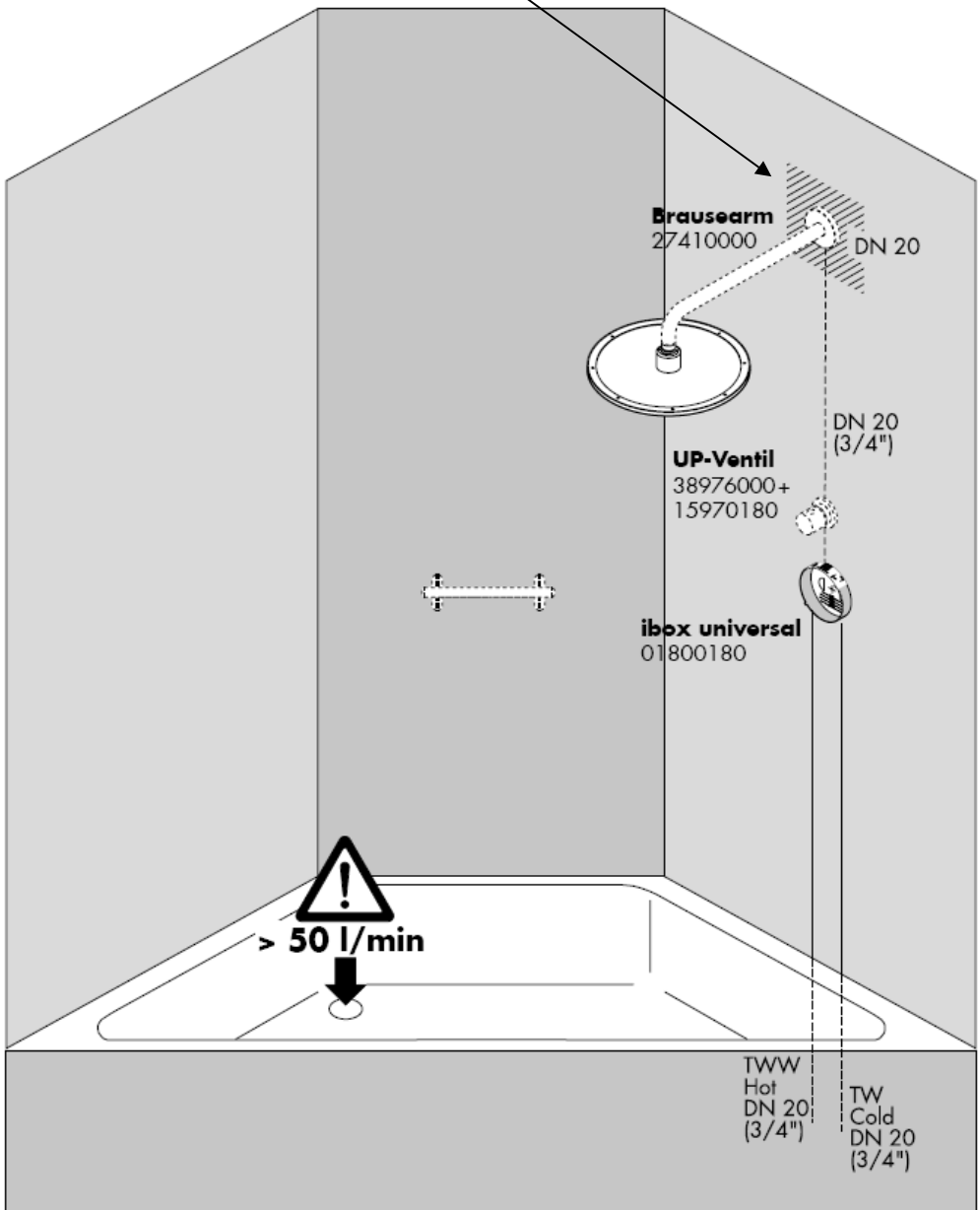

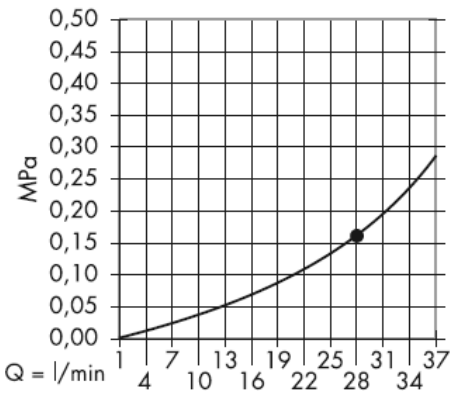

Ab • ist die Funktion gewährleistet.

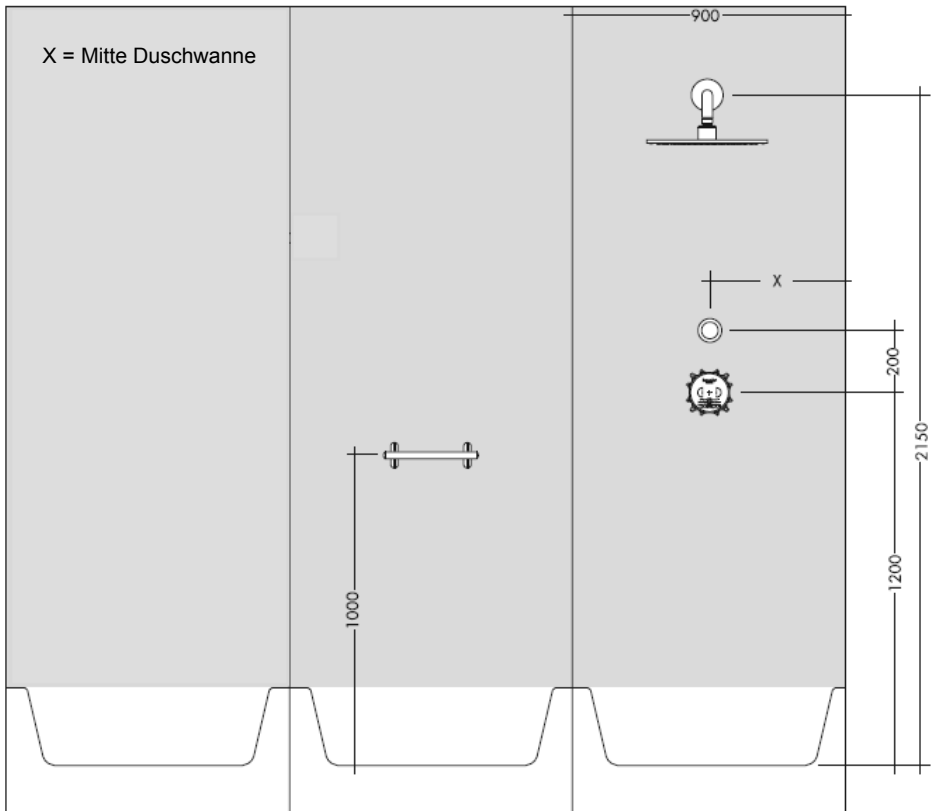

Wandverstärkung für Brausearmbefestigung notwendig

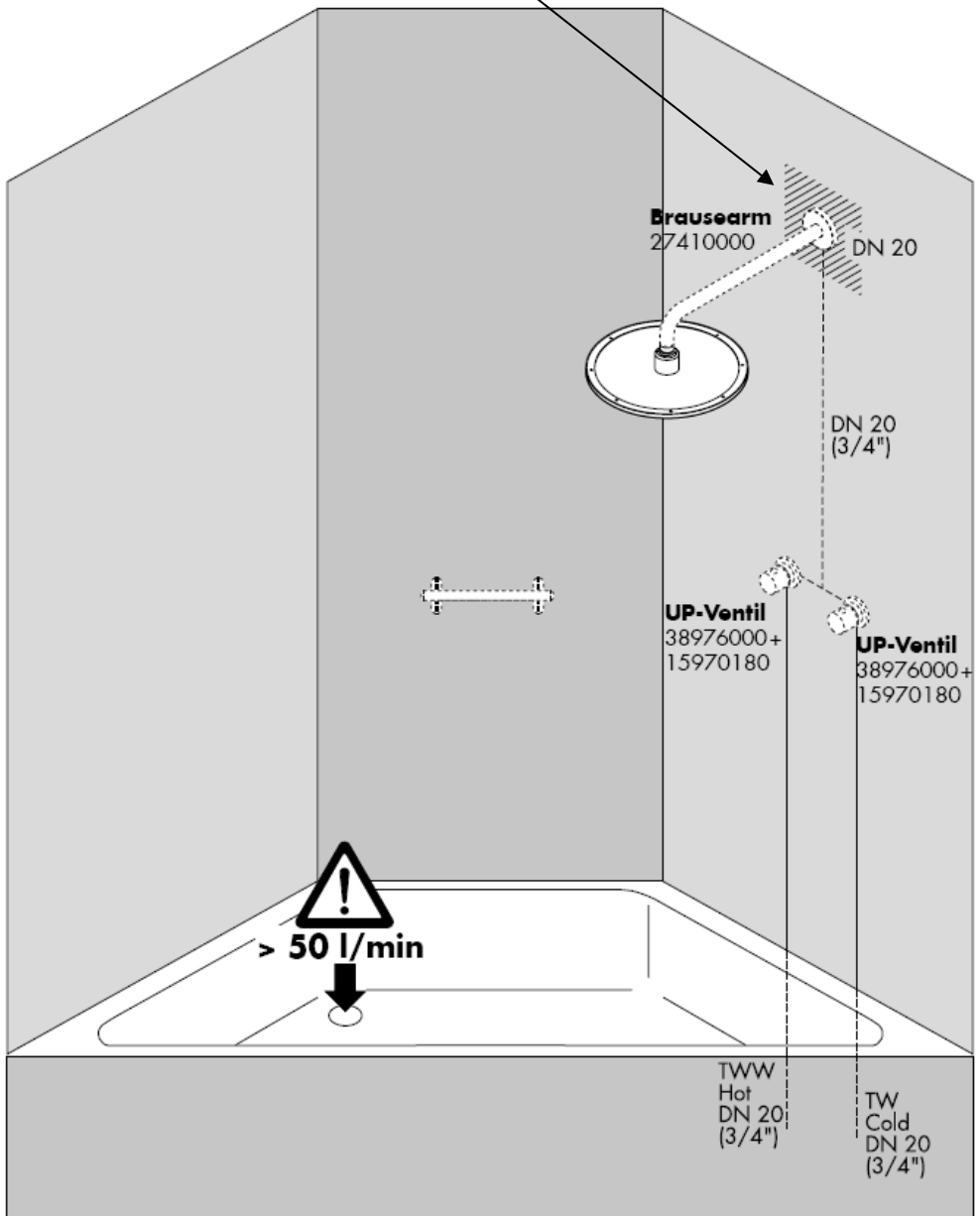

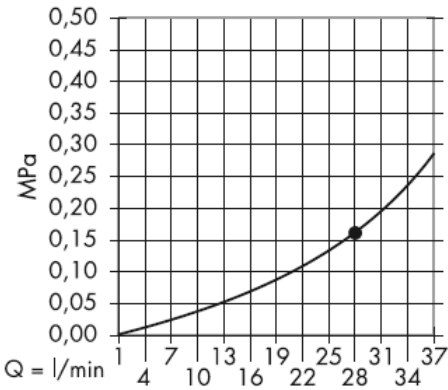

Ab • ist die Funktion gewährleistet.

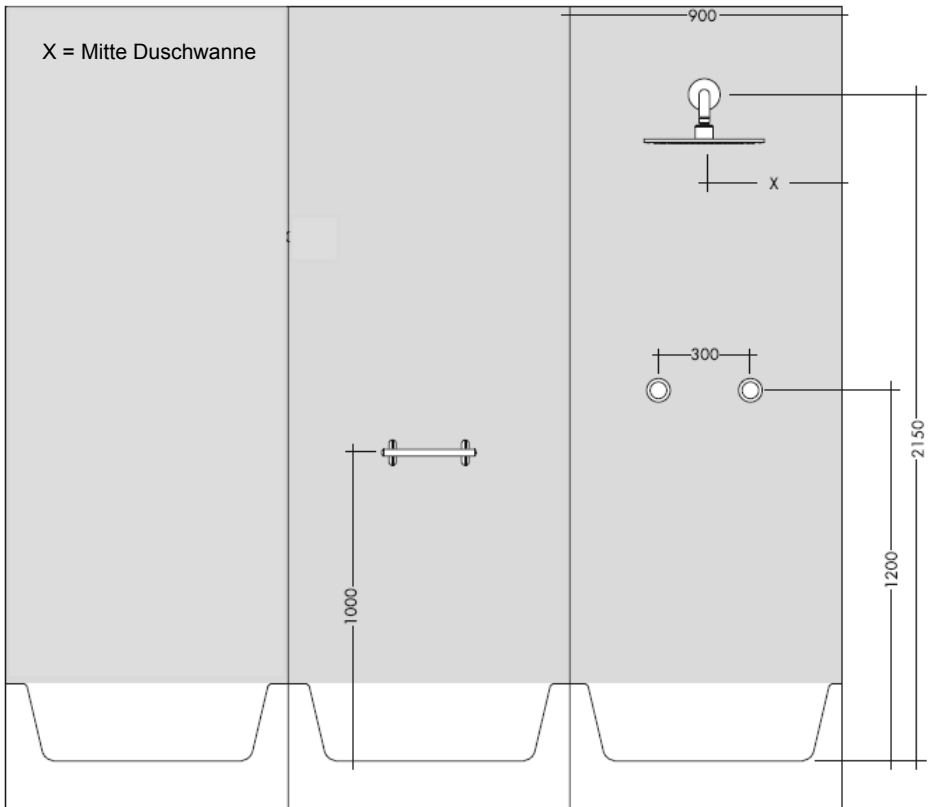

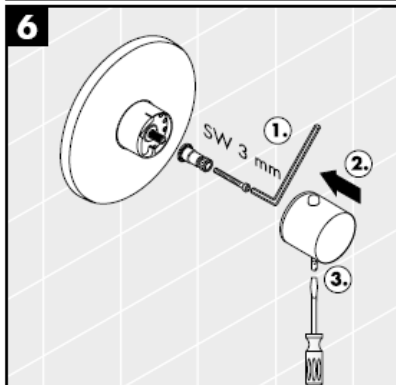
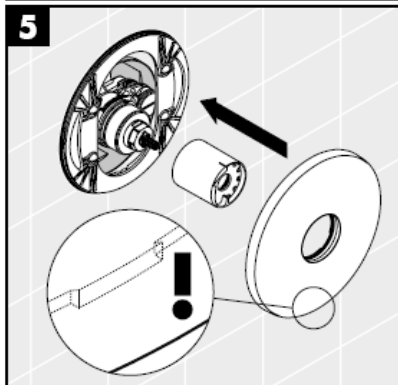
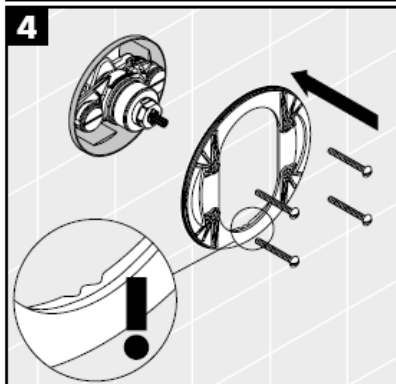
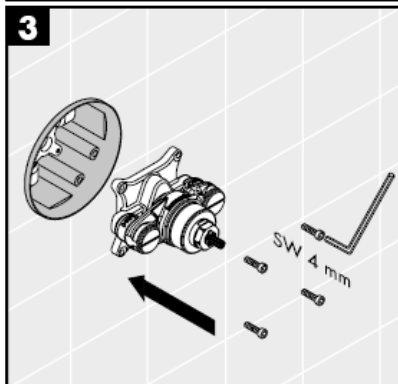
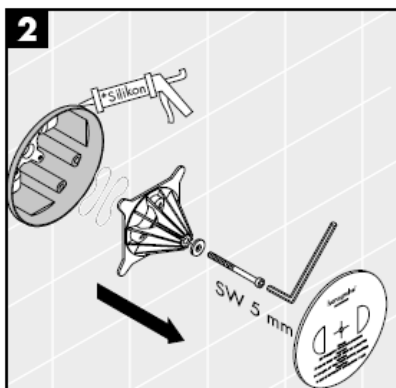
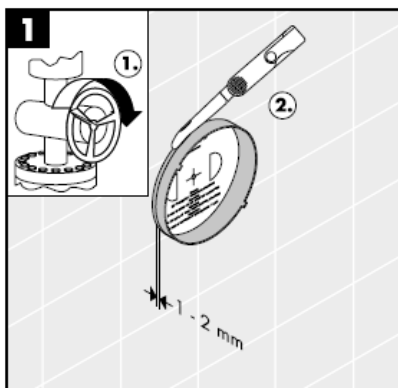

Silikon (essigsäurefrei!)

Dank der Safety Function lässt sich die gewünschte Höchsttemperatur von z. B. max. 42 C voreinstellen.

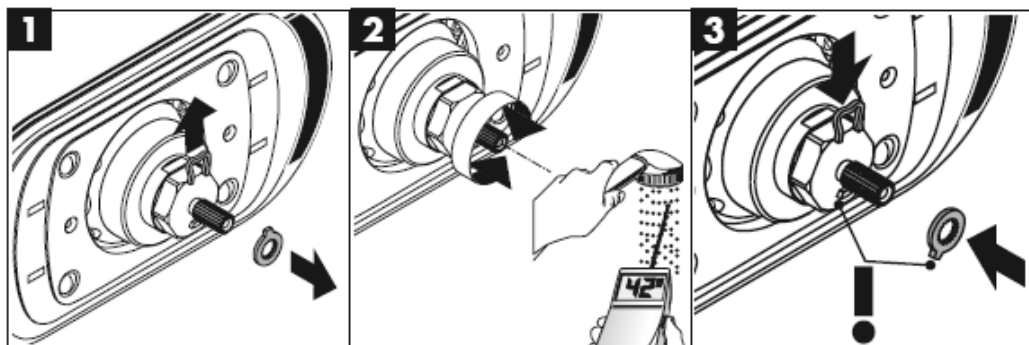

Einjustieren

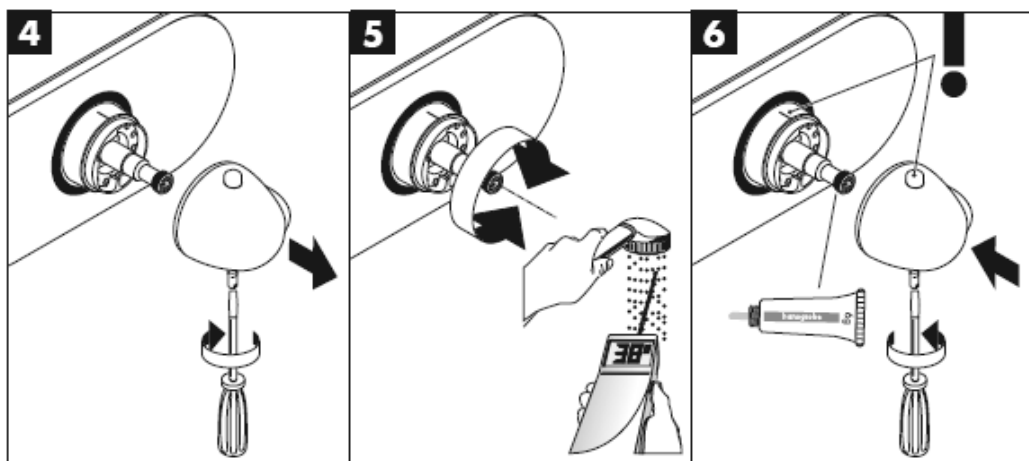



Ist die Brause in Funktion, hat diese zusammen mit dem Brausearm ein Gewicht von ca. 10 kg. Darum darf nur für das Mauerwerk geeignetes Befestigungsmaterial verwendet werden! Die beigelegten Schrauben und Dübel sind nur für massives Mauerwerk.

Es darf nur für das Mauerwerk geeignetes Befestigungsmaterial verwendet werden! Die beigelegten Schrauben und Dübel sind nur für massives Mauerwerk.

Die Ablaufleistung muss ausreichend dimensioniert werden.

Optimale Funktion nur in Verbindung mit Hansgrohe High Flow Thermostaten garantiert.

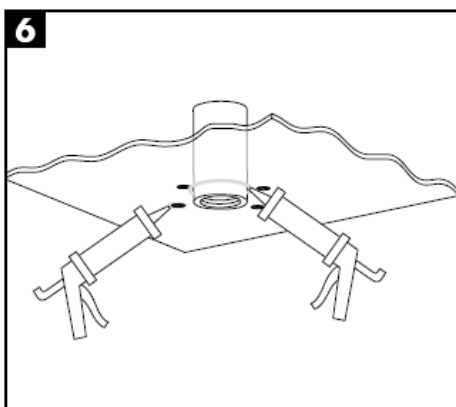
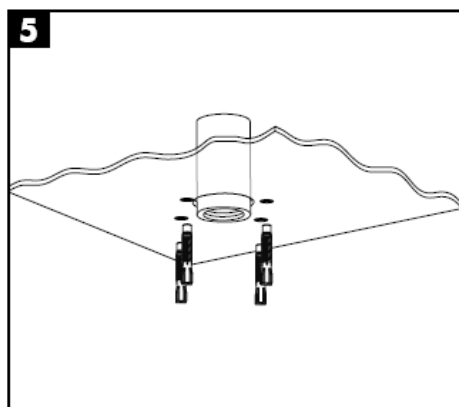
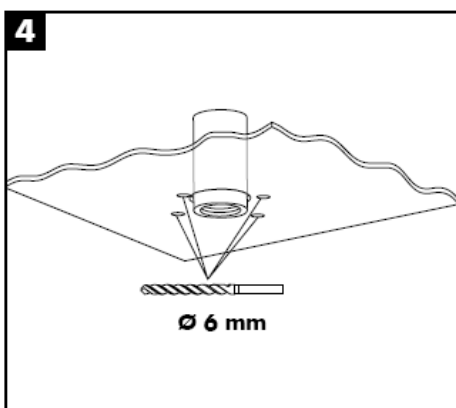
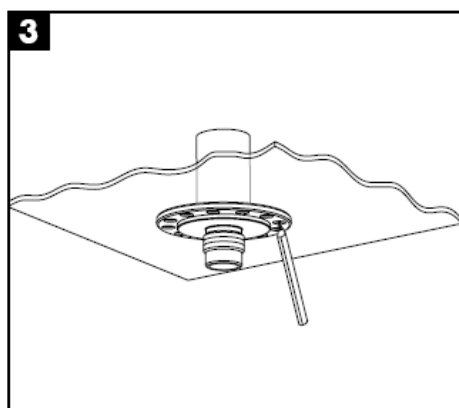
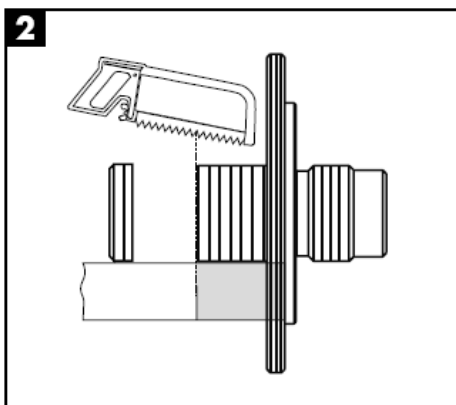
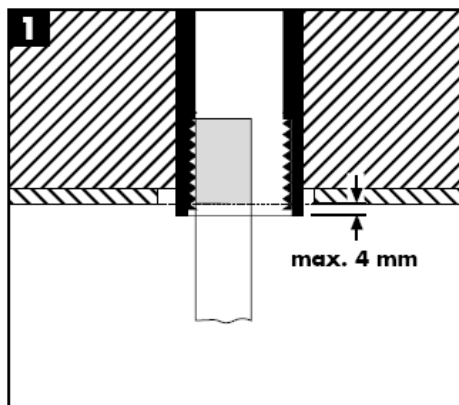

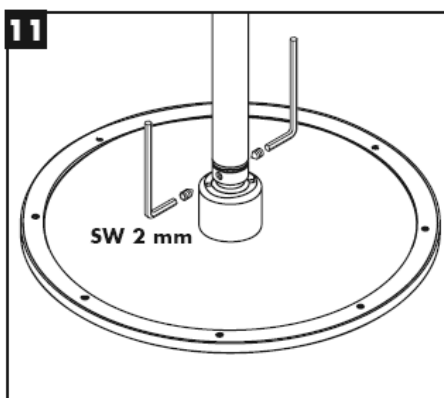
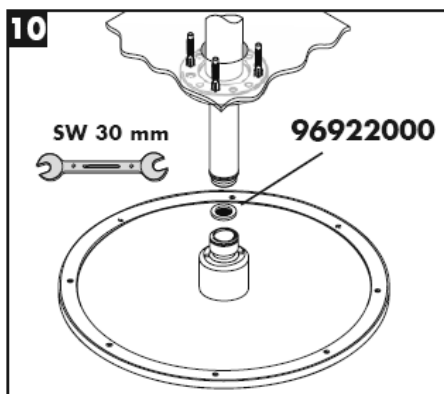
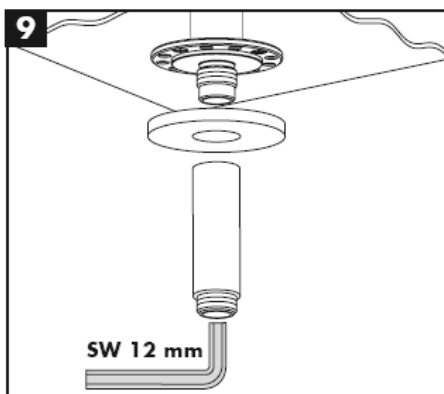
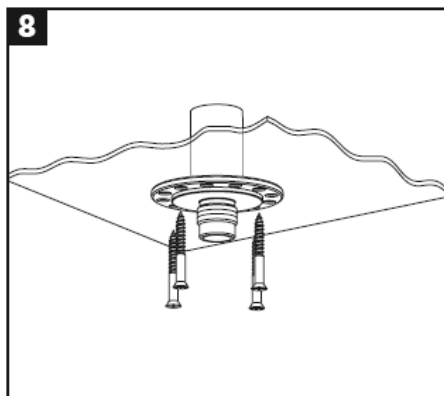
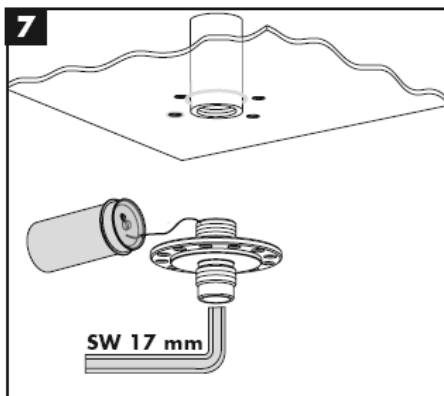

Die der Brause beige packte Siebdichtung muss eingebaut werden, um Schmutzeinspülungen aus dem Leitungsnetz zu vermeiden. Schmutzeinspülungen können die Funktion beeinträchtigen und/oder zu Beschädigungen an Funktionsteilen der Brause führen, für hieraus ergebende Schäden haftet Hansgrohe nicht.

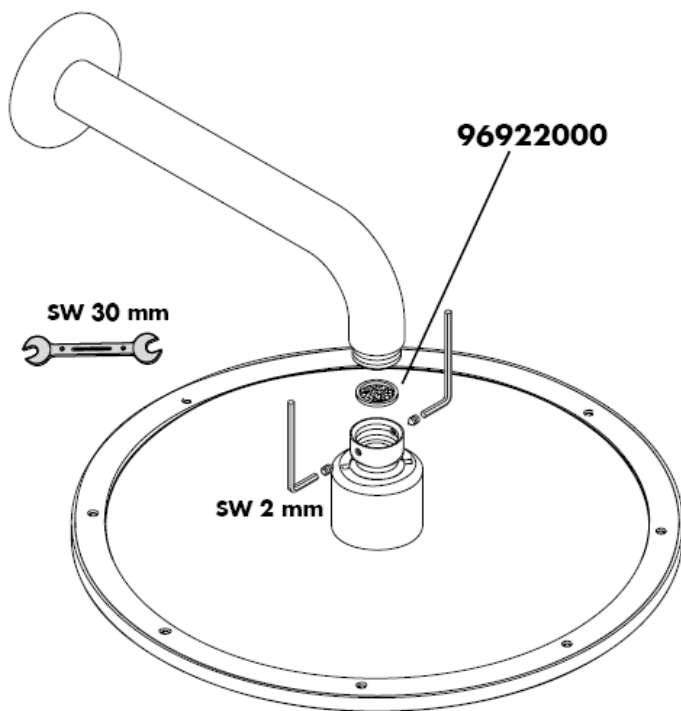

Montage

Achtung! Die Armatur muss nach den gültigen Normen montiert, gespült und geprüft werden!

Einjustieren

Eine Korrektur ist erforderlich, wenn die an der Entnahmestelle gemessene Temperatur von der am Thermostat eingestellten Temperatur abweicht. Dabei ist folgendes zu beachten: Skalengriff drehen, bis an der Entnahmestelle Wasser mit 38 °C austritt. Griffschraube lösen, Griff zurückziehen und bis Stellung 38 °C drehen. Griff aufstecken und Griffschraube festziehen (siehe Seite 22).

Temperaturbegrenzung

Der Temperaturbereich wird durch die Sicherheitssperre auf 38 °C begrenzt (Verbrühschutz).

Wird eine höhere Temperatur gewünscht, so kann durch Eindrücken des Sicherheitsknopfes die 38 °C Sperre überschritten werden.

Safety Function

Dank der Safety Function lässt sich die gewünschte Höchsttemperatur von z. B. max. 42 °C voreinstellen. siehe Seite 21.

Technische Daten

Betriebsdruck: max. 1 MPa
 Empfohlener Betriebsdruck: 0,1 – 0,5 MPa
 Prüfdruck: 1,6 MPa
 (1 MPa = 10 bar = 147 PSI)
 Heißwassertemperatur: max. 80° C
 Empfohlene Heißwassertemperatur: 65° C
 Durchflussleistung: ca. 58 l/min 0,3 MPa

Wartung

Thermostate bedürfen keiner besonderen Wartung. Rückflussverhinderer müssen gemäß DIN EN 1717 regelmäßig in Übereinstimmung mit nationalen oder regionalen Bestimmungen (DIN 1988 einmal jährlich) auf ihre Funktion geprüft werden. Überprüfen Sie bei dieser Gelegenheit auch die Schmutzfänger, welche sich auf der MTC-Regeleinheit (6.1) befinden. Nach Montage der MTC-Regeleinheit (6) unbedingt die Auslaufterperatur überprüfen, wie unter Punkt "Einjustieren" beschrieben. Überprüfen Sie unbedingt zuvor, ob die Warmwasserversorgung eingeschaltet ist und die max. Warmwassertemperatur an der Zapfstelle anliegt.

Um die Leichtgängigkeit der Regeleinheit zu gewährleisten, sollte der Thermostat von Zeit zu Zeit auf ganz warm und ganz kalt gestellt werden.

Serviceteile siehe Seite 3

1	Thermostatgriff	38391000
2	Rosette	96452000
3	Hülse	97439000
4	Trägerschrauben	96454000
5	Trägerrosette	96447000
6	Temperatur Regeleinheit	96633000
7	Schmutzfangsieb	97367000
8	Rückflussverhinderer	96655000
9	Verlängerung 25 mm	13595000
10	Verlängerung 25 mm	13596000

Deutsch

Störung	Ursache	Abhilfe
Wenig Wasser	-Versorgungsdruck nicht ausreichend -Schmutzfangsieb der Regeleinheit verschmutzt -Siebdichtung der Brause verschmutzt	-Leitungsdruck prüfen -Schmutzfangsiebe reinigen -Siebdichtung zwischen Brause und Schlauch reinigen
Kreuzfluss, warmes Wasser wird bei geschlossener Armatur in die Kaltwasserleitung gedrückt oder umgekehrt	-Rückflussverhinderer verschmutzt / defekt	-Rückflussverhinderer austauschen
Auslauftemperatur stimmt nicht mit der eingestellten Temperatur überein	-Thermostat wurde nicht justiert -Zu niedere Warmwassertemperatur	-Thermostat justieren -Warmwassertemperatur erhöhen auf 42 C bis 65 C
Temperaturregelung nicht möglich	-Temperaturregeleinheit verschmutzt oder verkalkt -Funktionsblock um 180° verdreht einbauen	-Bei Neuinstallation Grundkörper falsch angeschlossen (Soll: kalt rechts, warm links) oder 180° verdreht eingebaut -Druckknopf der Sicherheitssperre ohne Funktion
Feder defekt	-Feder bzw. Druckknopf reinigen u. leicht fetten, ggf. austauschen -Druckknopf verkalkt	-Feder bzw. Druckknopf reinigen u. leicht fetten, ggf. austauschen -Feder bzw. Druckknopf reinigen u. leicht fetten, ggf. austauschen

Prüfzeichen

	P-IX	DVGW	SVGW	WRSA	KIWA	ACS	NF
27070000						X	
27418XXX							
28420000						X	
28435XXX						X	

Reinigung

Einfach sauber: Kalk lässt sich von den Noppen ganz leicht abrubbeln.

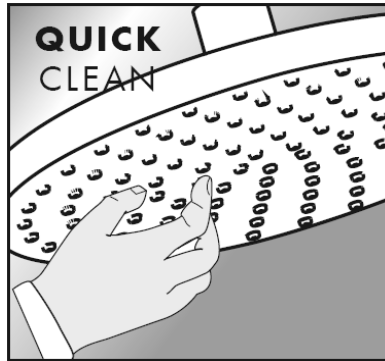

Pflegeanleitung

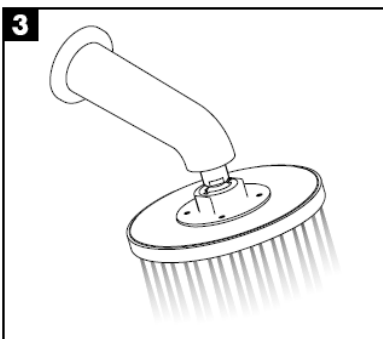
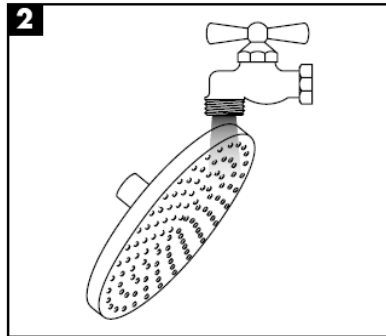
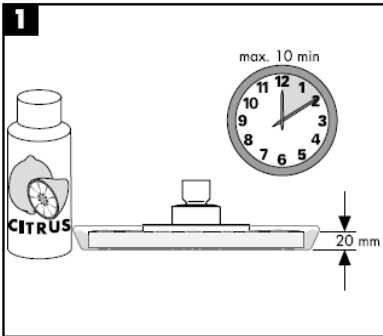

hansgrohe

Instructions de montage



27418XXX

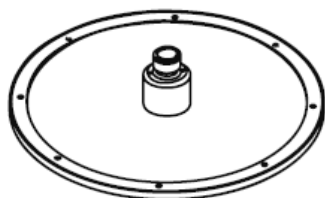

Raindance Royale AIR
28420000

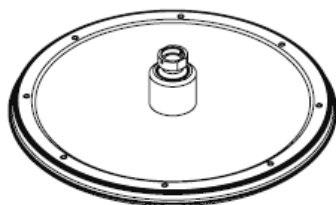

Raindance Royale Classic AIR
28435XXX

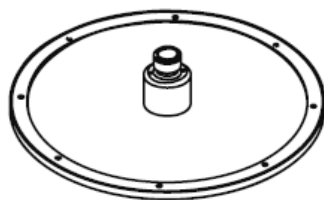

**Raindance Royale
High Flow Set**
27070000

hangrohe

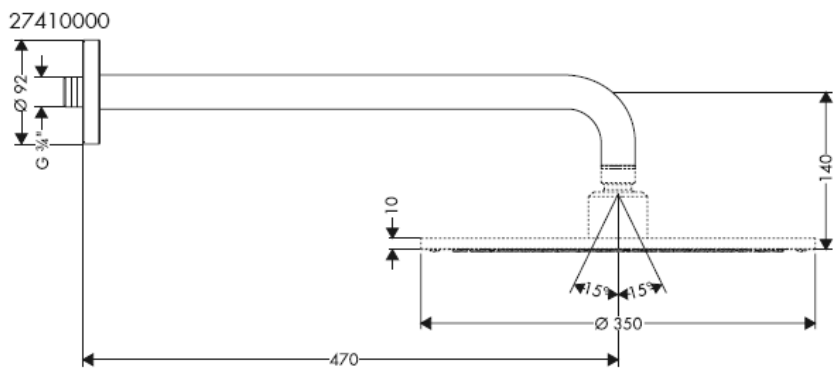
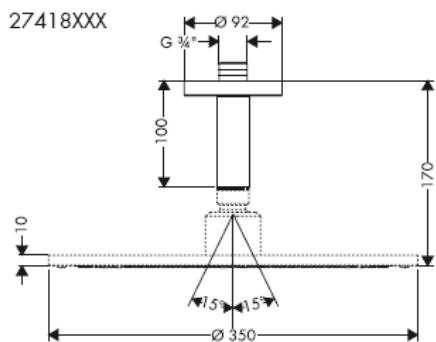
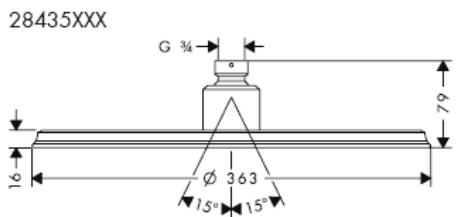
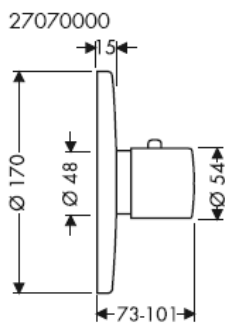
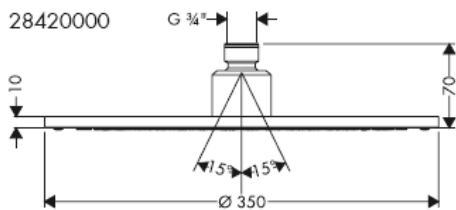

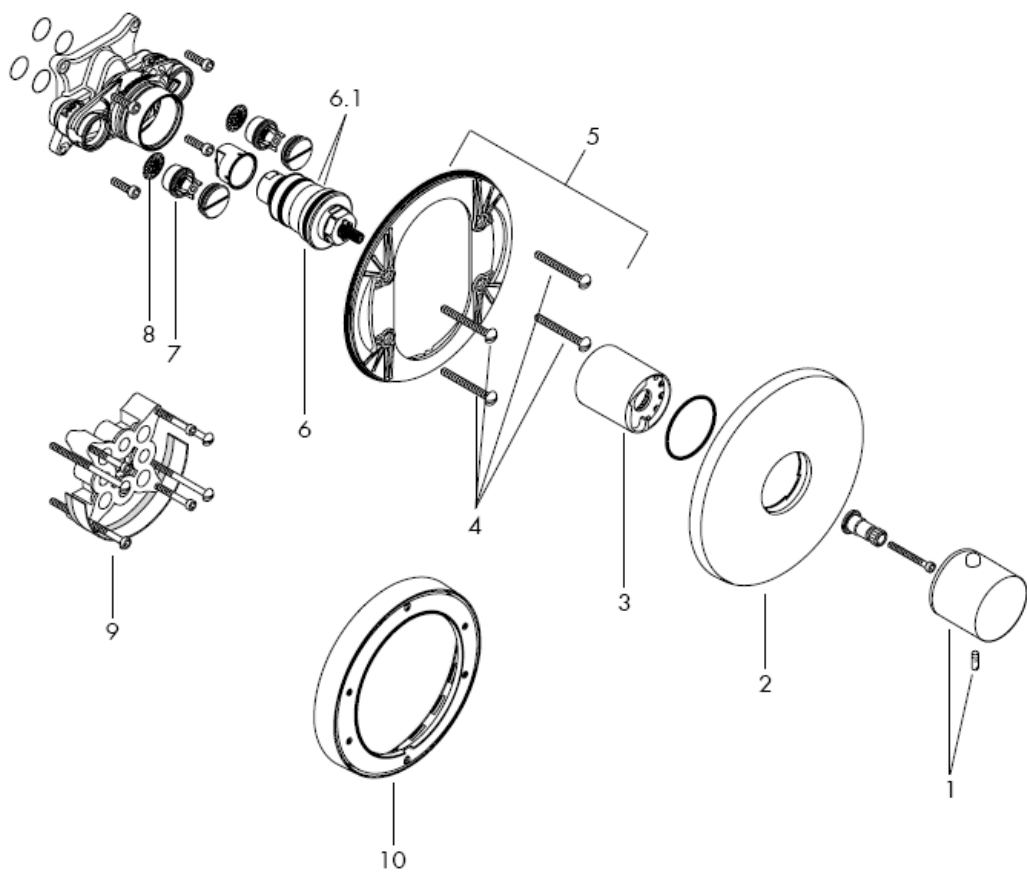

Adapter si possible, les mesures à la dimension des carreaux.

Renforcement nécessaire de la paroi

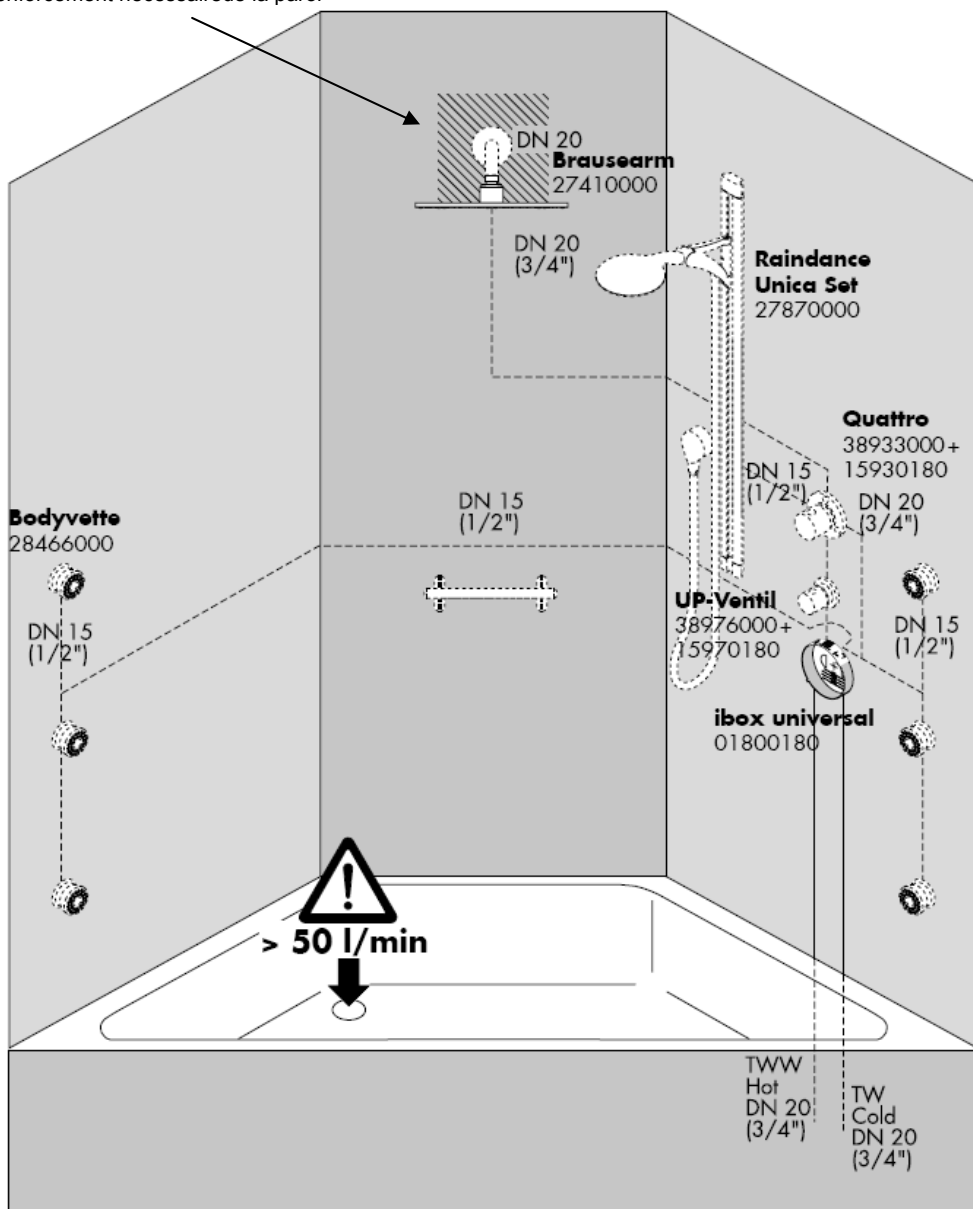

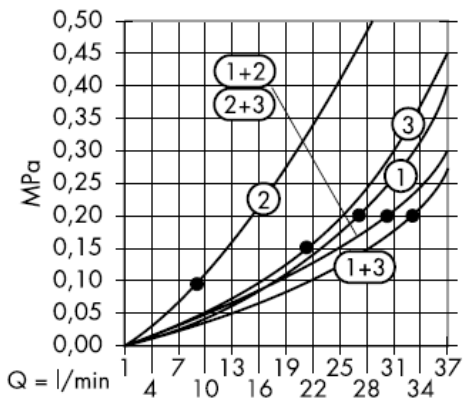

A partir de • le fonctionnement est garanti.

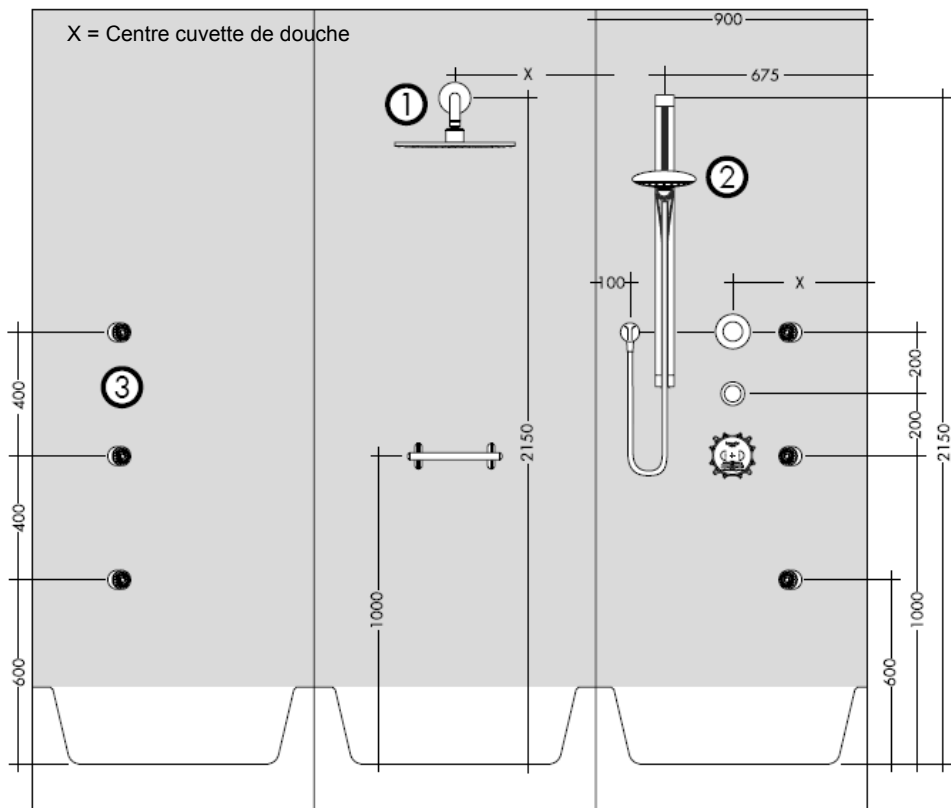

Renforcement nécessaire de la paroi

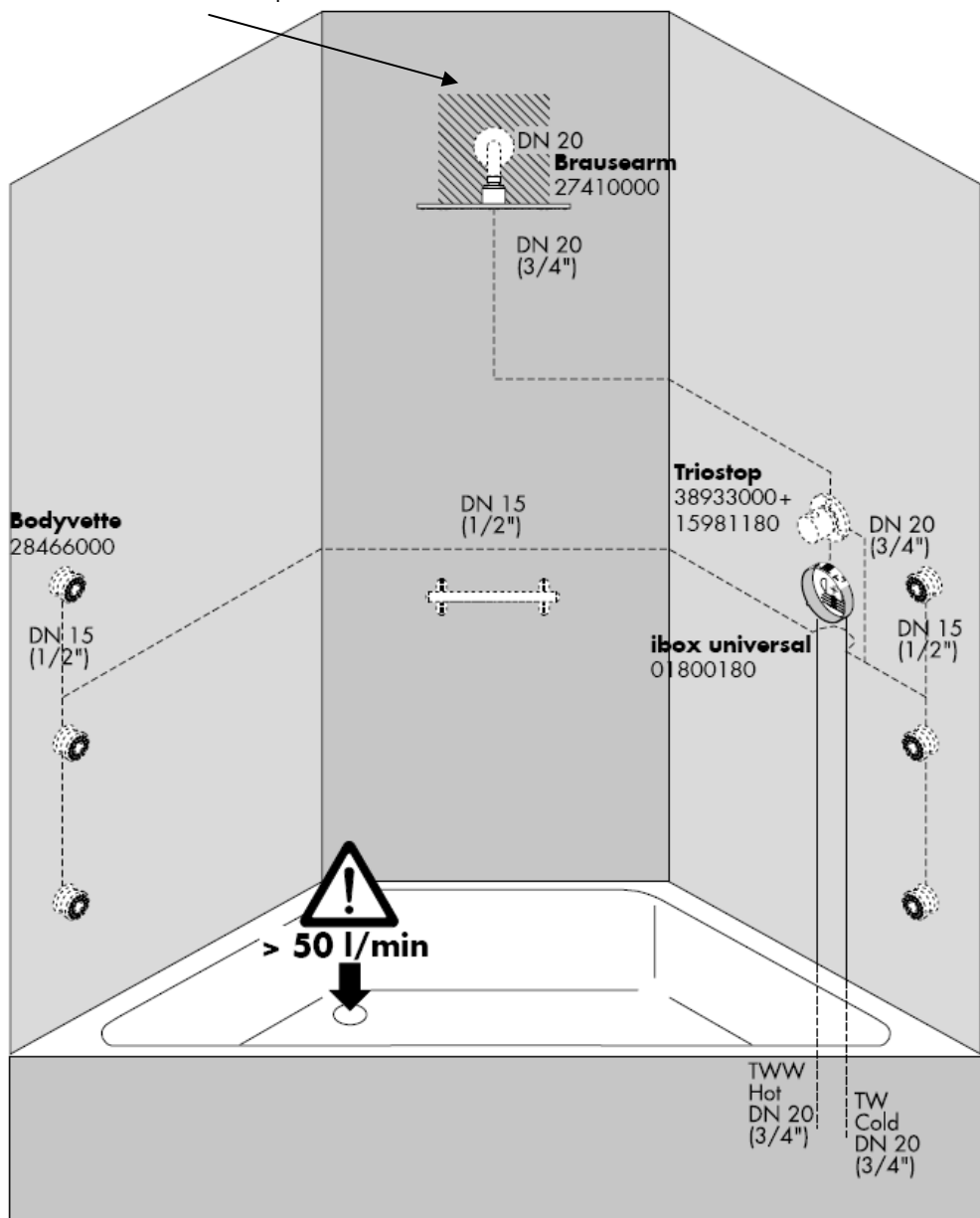

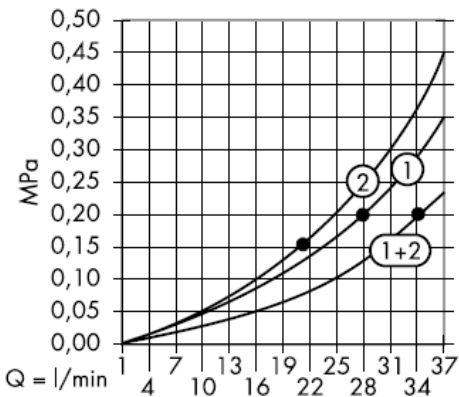

A partir de • le fonctionnement est garanti.

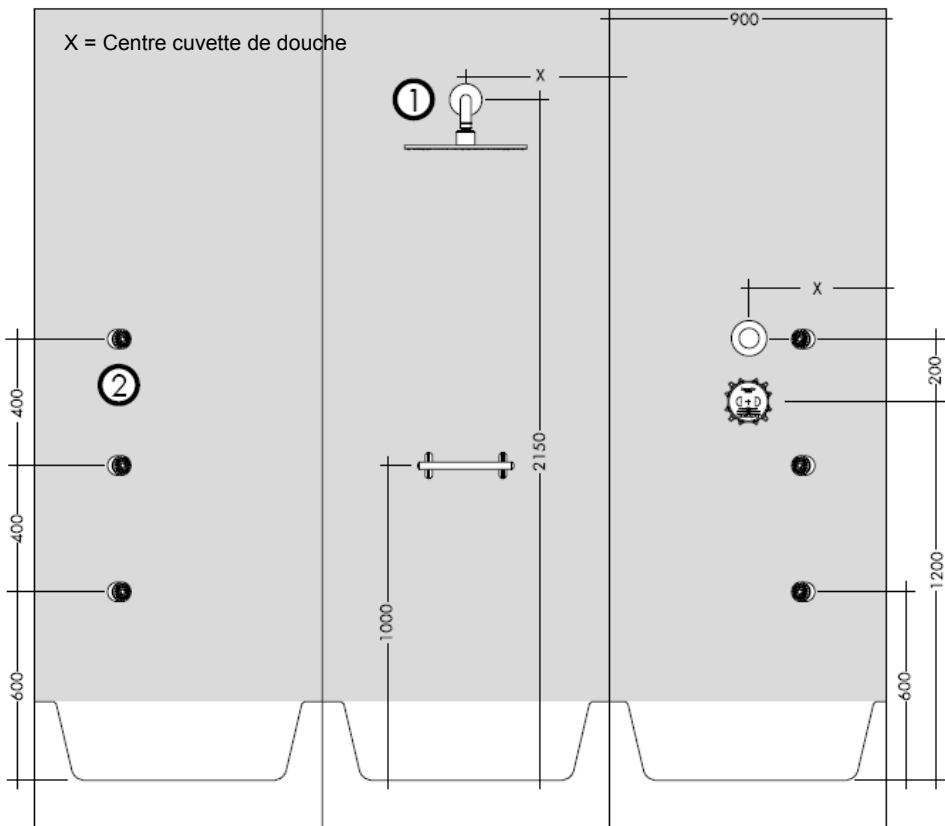

Renforcement nécessaire de la paroi

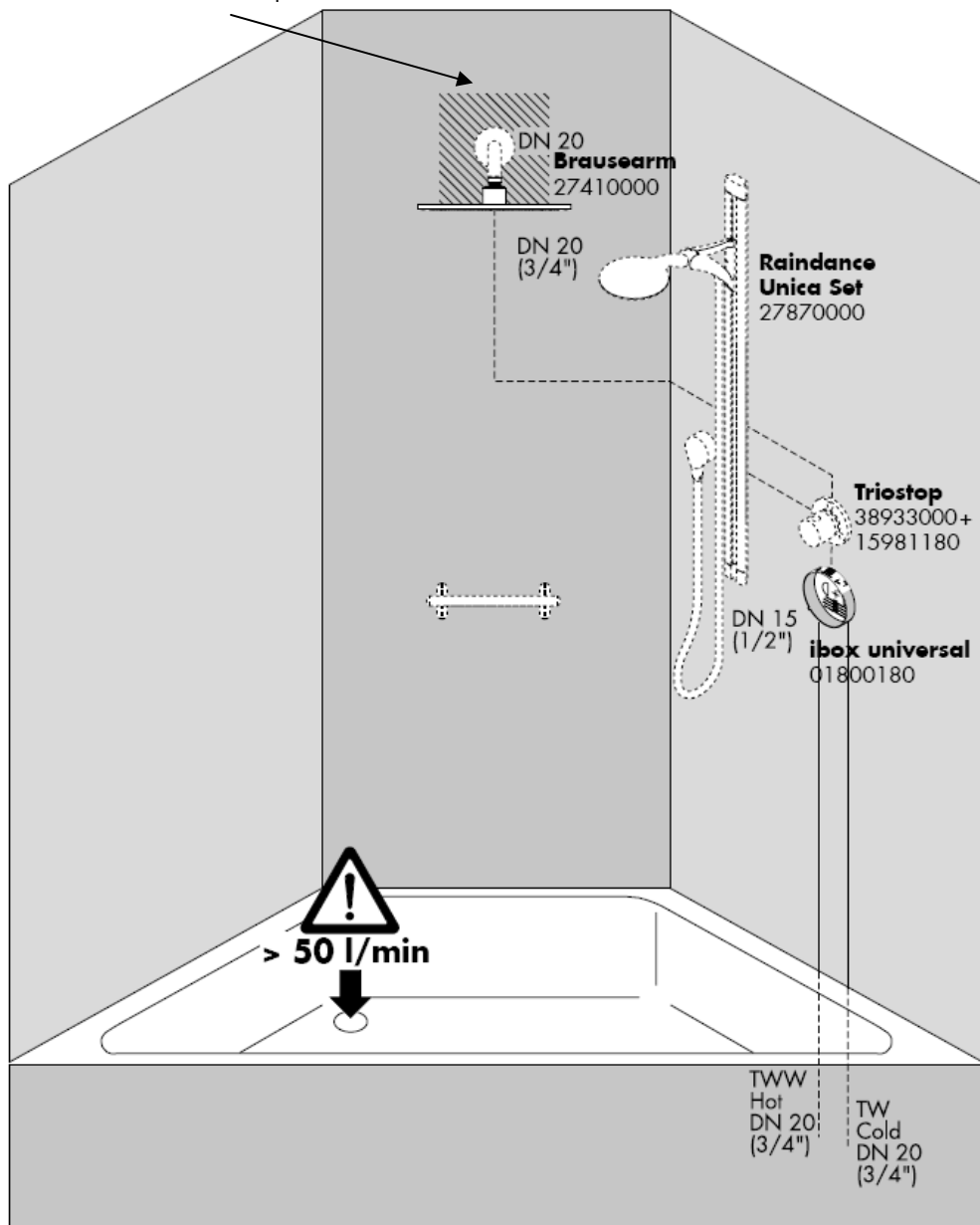

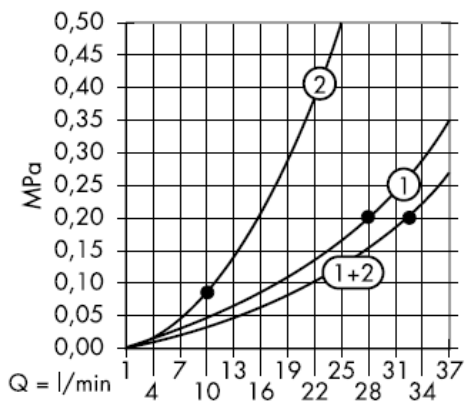

A partir de • le fonctionnement est garanti.

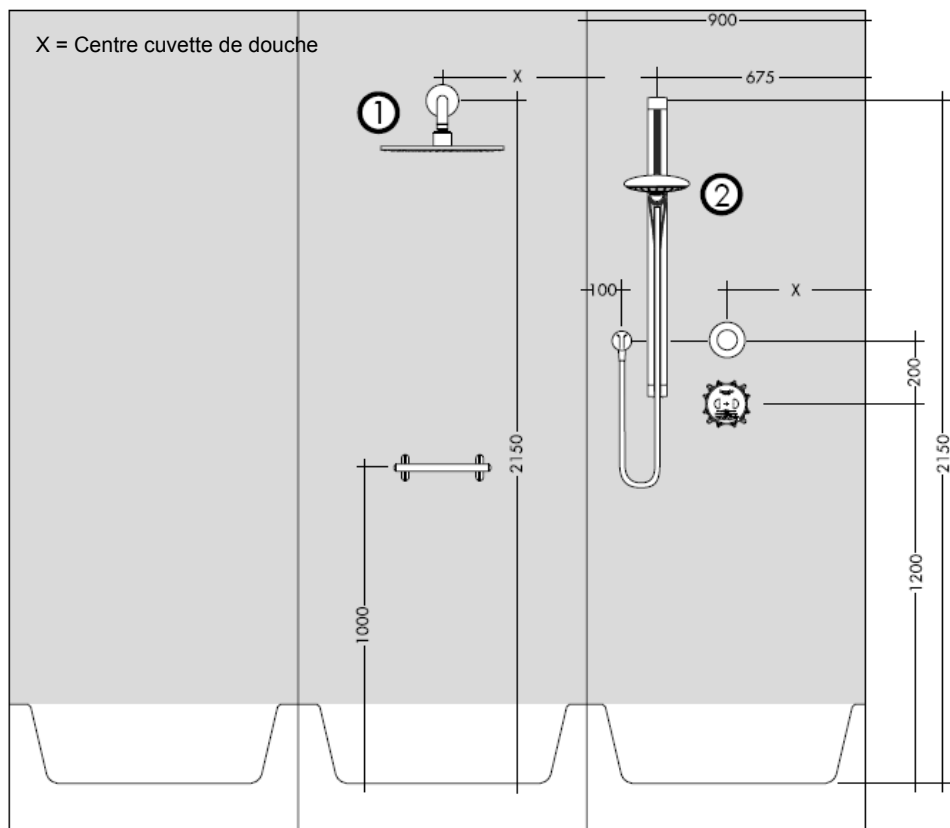

Renforcement nécessaire de la paroi

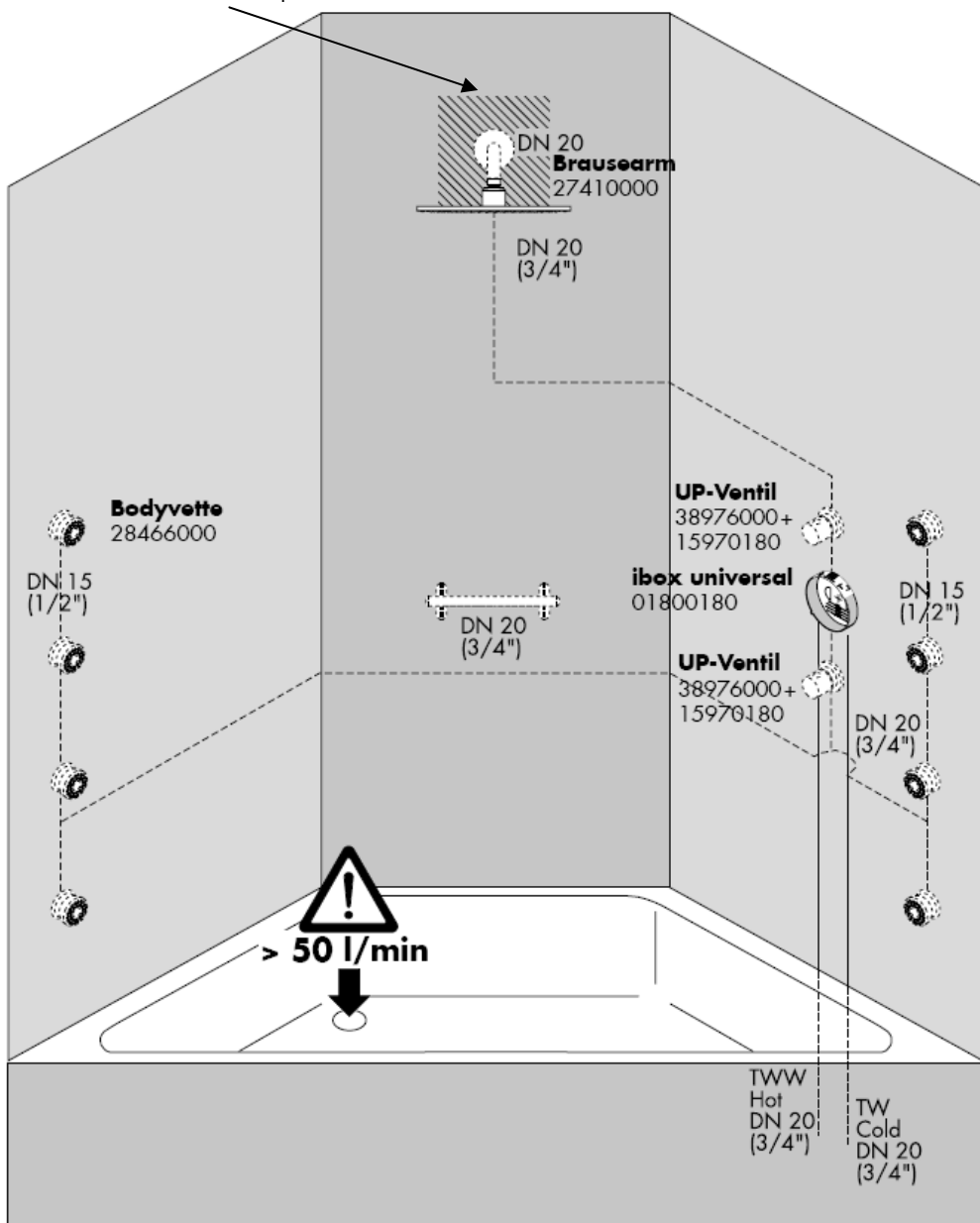

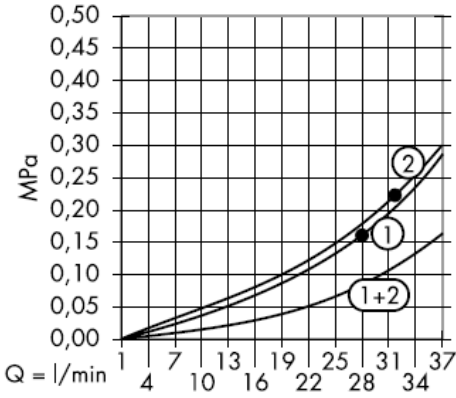

A partir de • le fonctionnement est garanti.

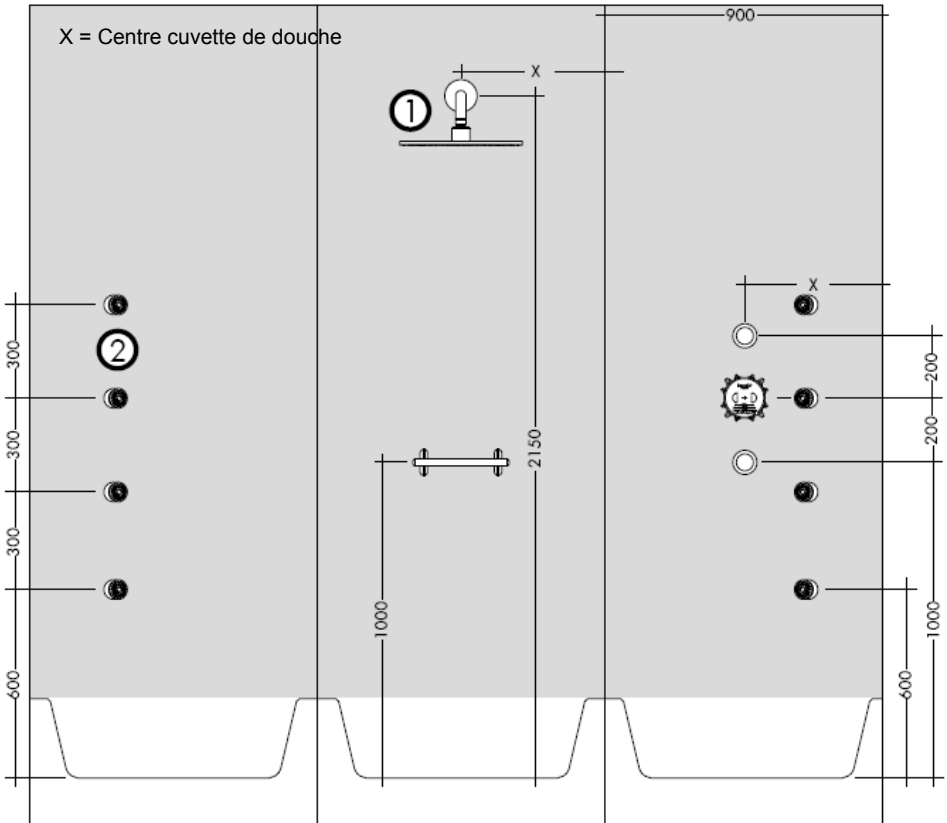

Renforcement nécessaire de la paroi

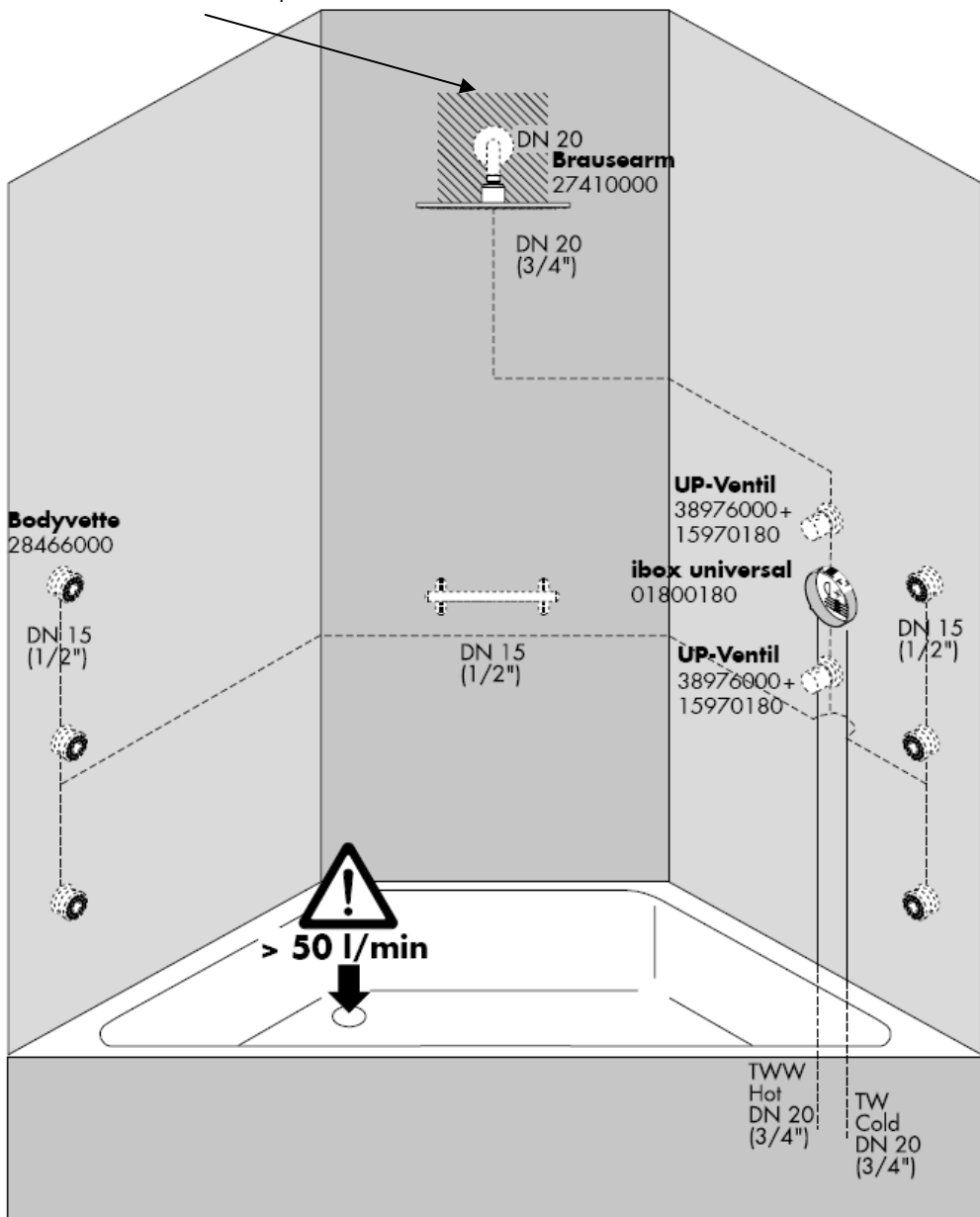

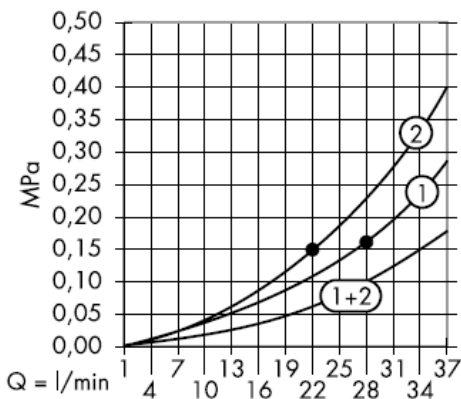

A partir de • le fonctionnement est garanti.

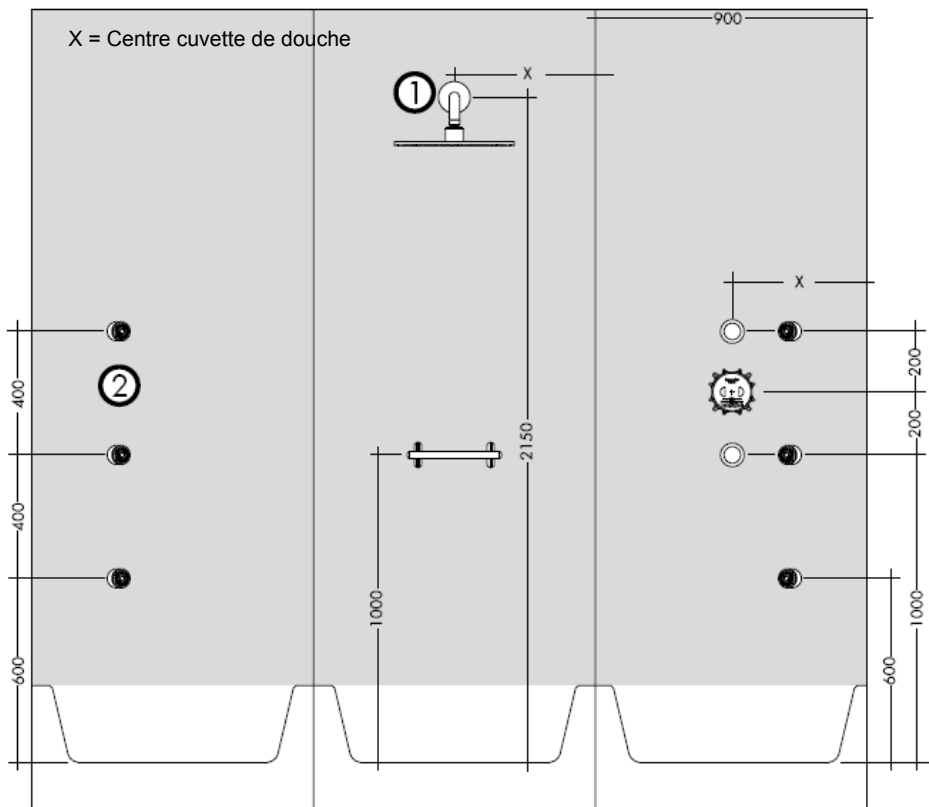

Renforcement nécessaire de la paroi

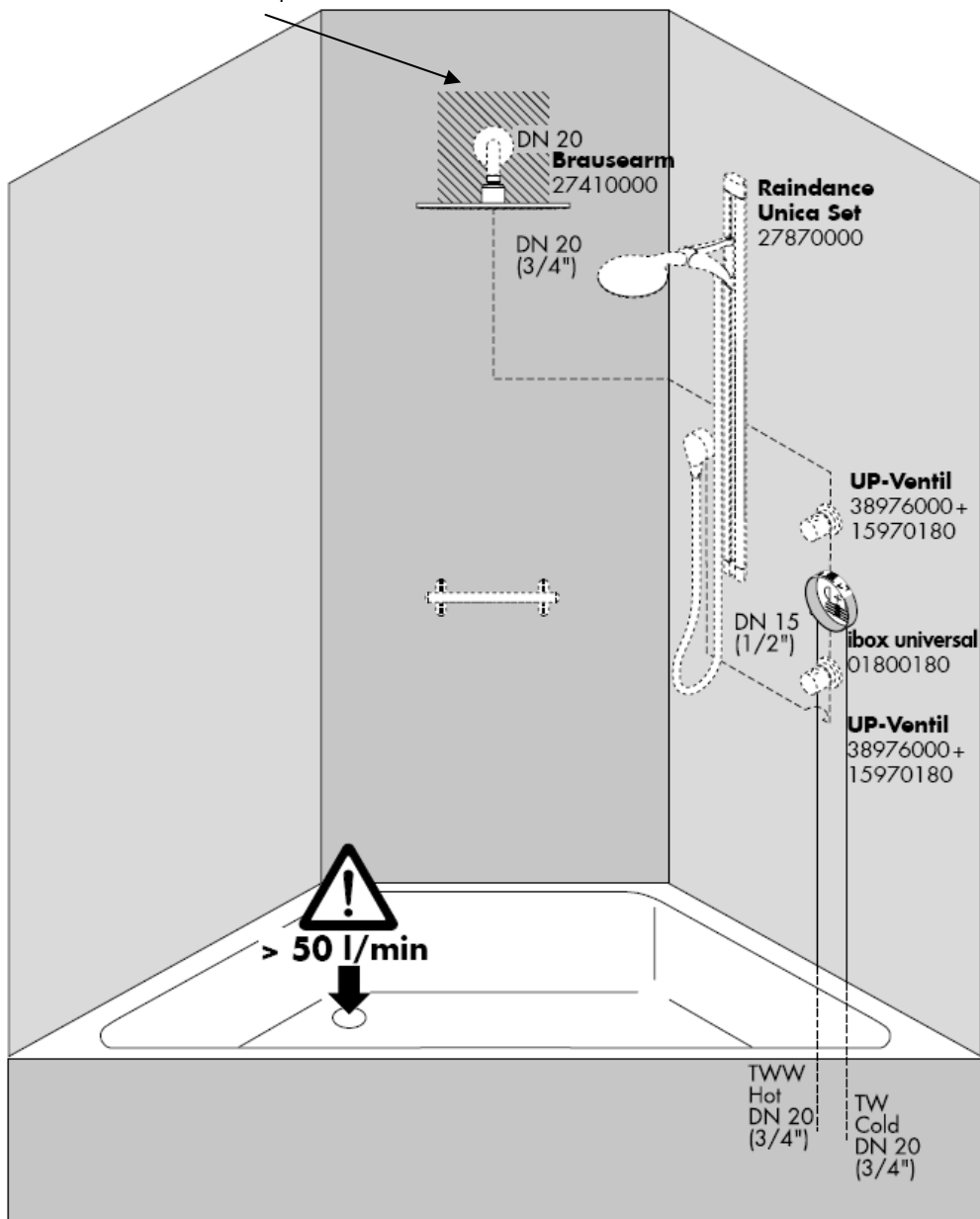

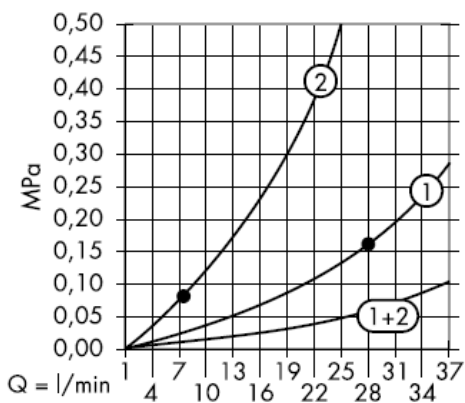

A partir de • le fonctionnement est garanti.

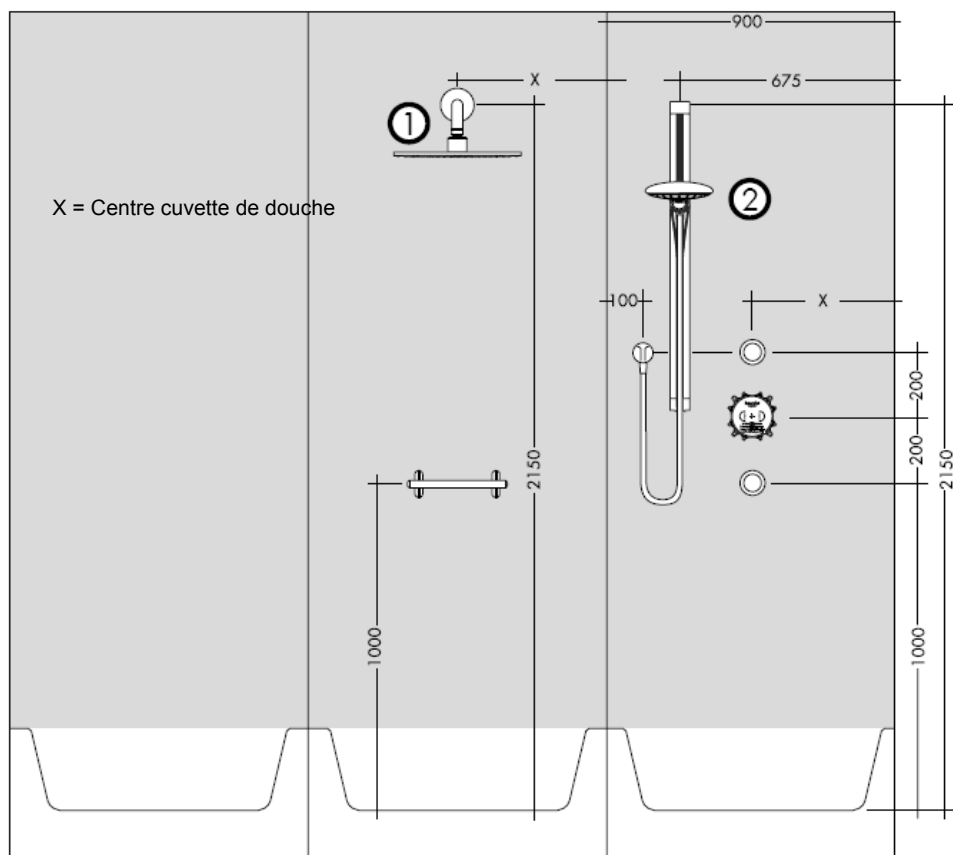

Renforcement nécessaire de la paroi

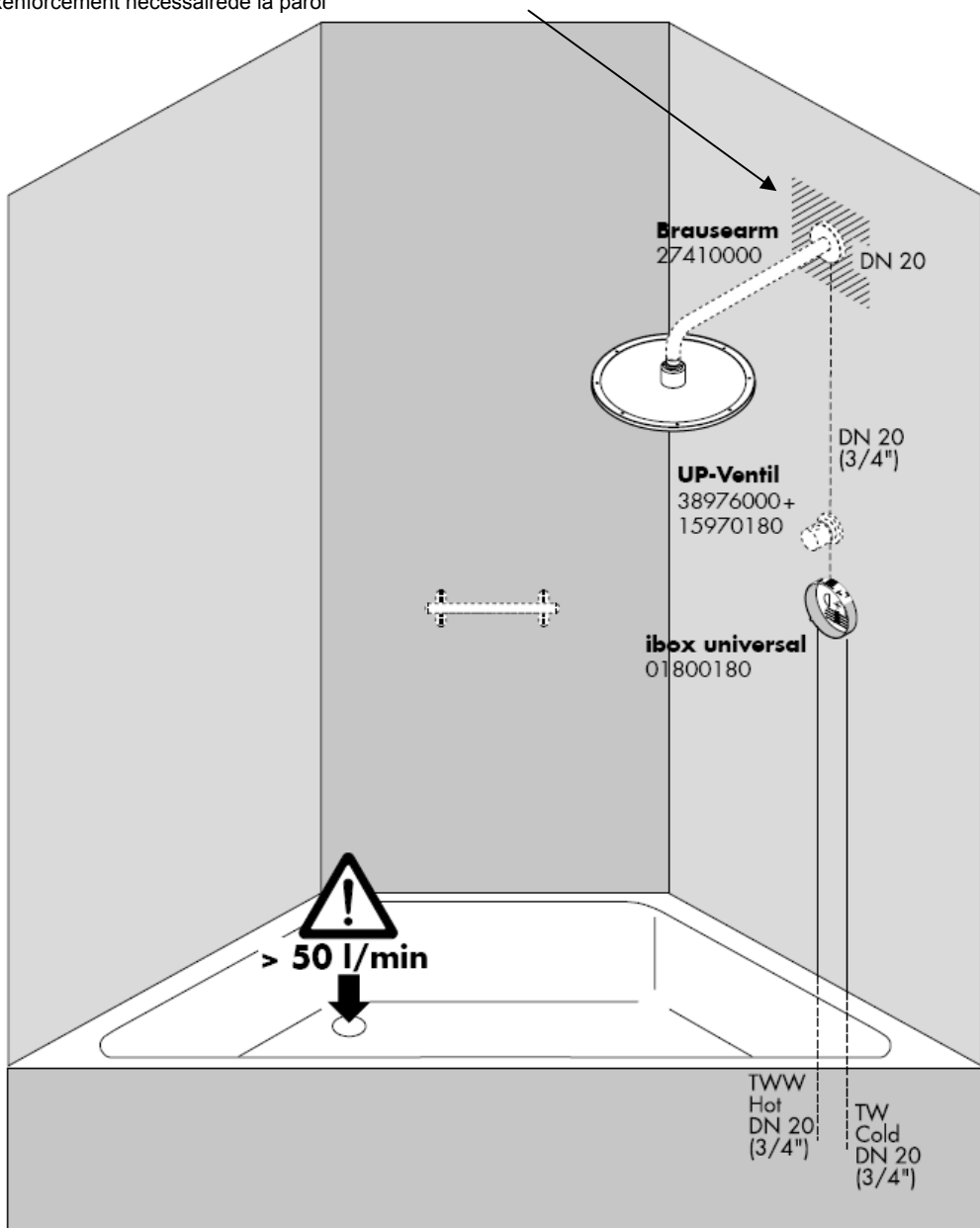

A partir de • le fonctionnement est garanti.

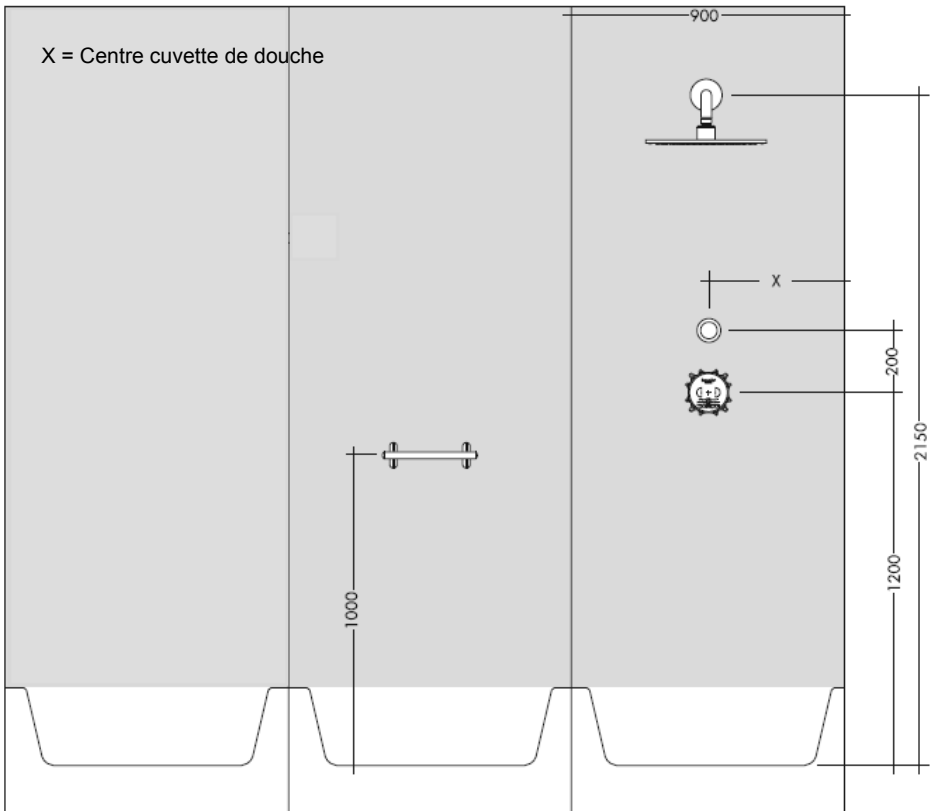
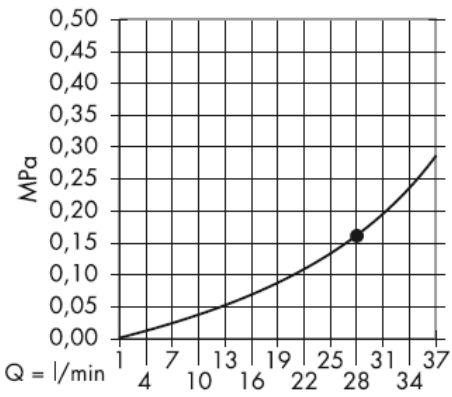

Renforcement nécessaire de la paroi

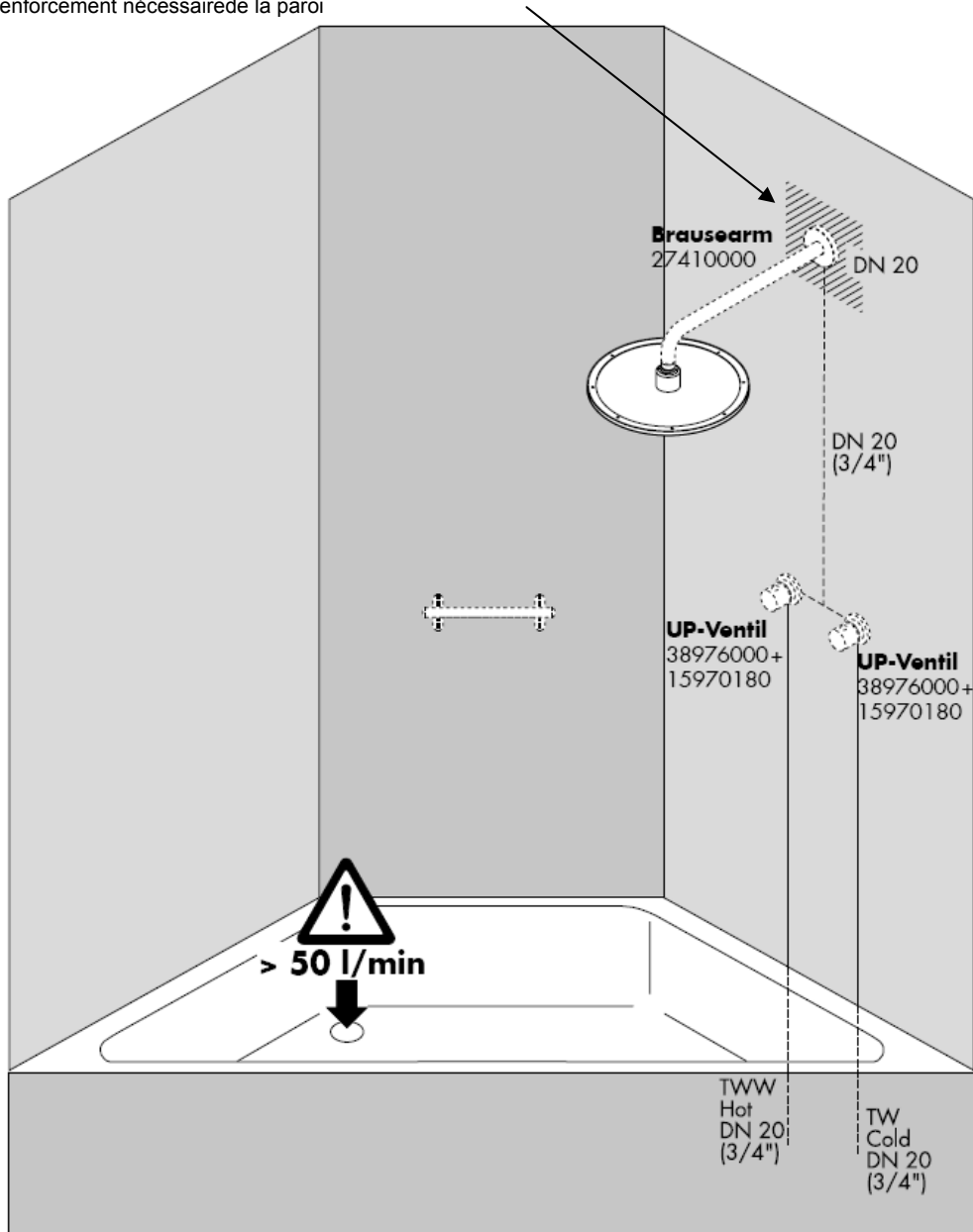

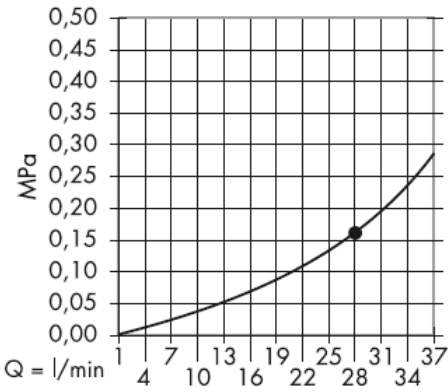

A partir de • le fonctionnement est garanti.

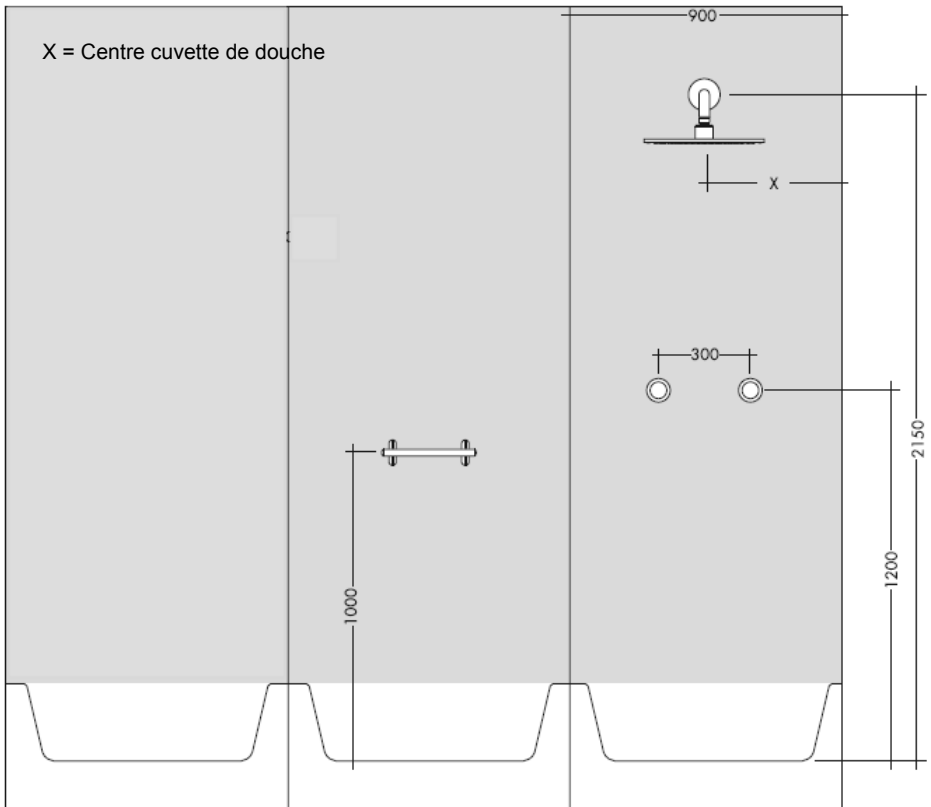

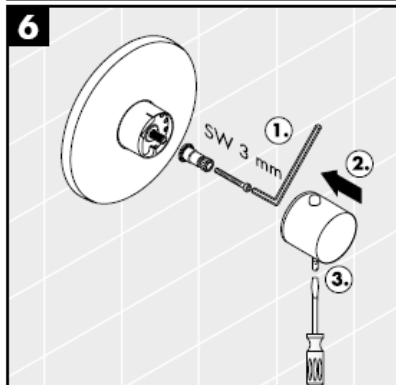
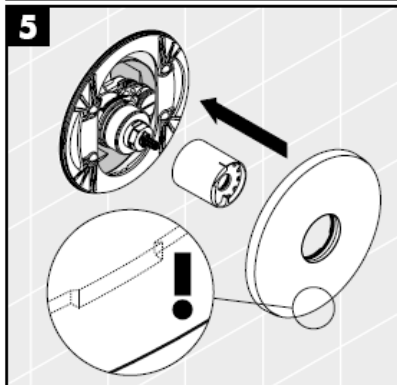
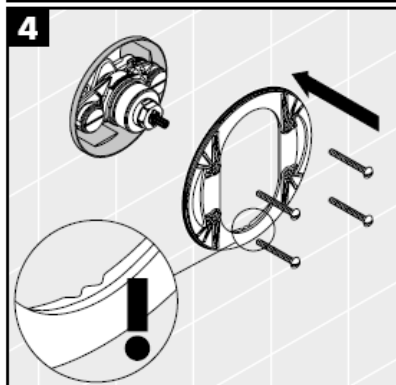
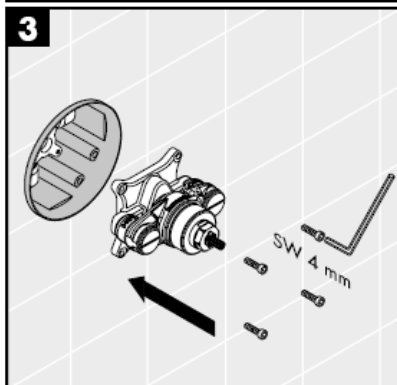
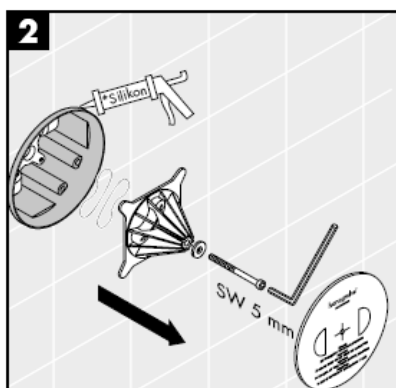
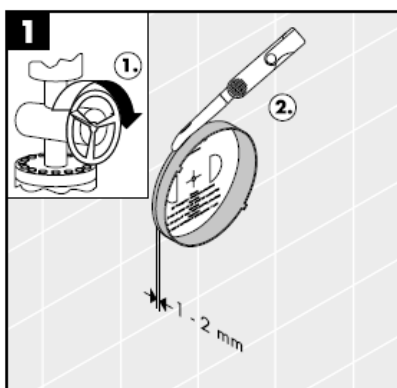

Silicone (sans acide acétique!)

Grâce à la fonction Safety, il est possible de prérégler la température maximale par exemple max. 42 C souhaitée.

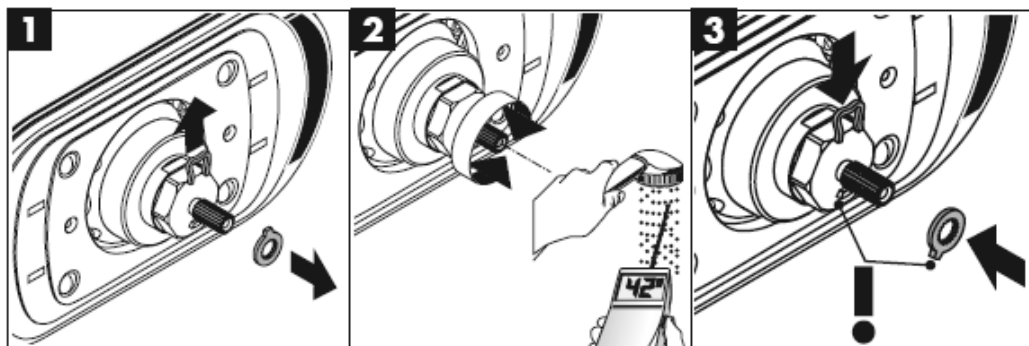

Réglage

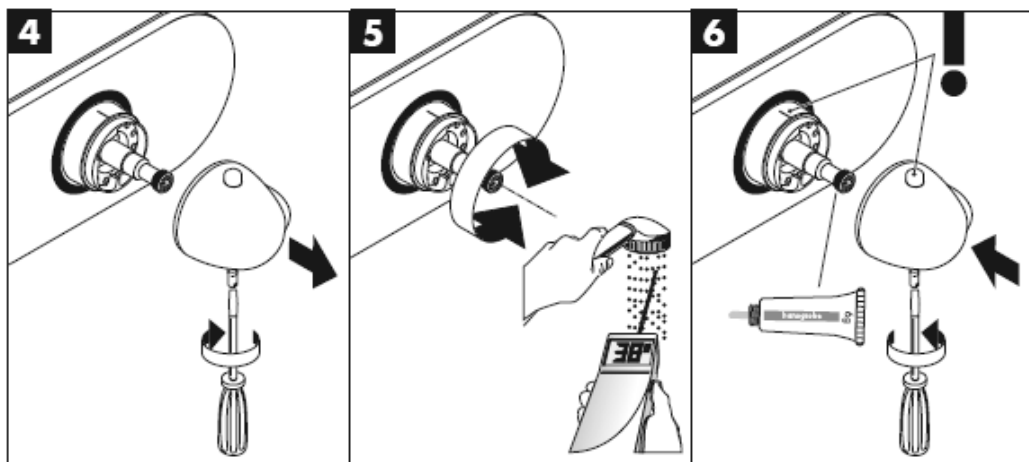



If the shower is in function, it has a weight of approximately 10 kg together with the shower arm. So only use fastening material suitable for the brickwork! The enclosed screws and dowels are only for solid brickwork.

N'utiliser qu'un matériel de fixation adapté à la maçonnerie en place ! Les vis et chevilles incluses dans la livraison ne conviennent qu'aux maçonneries pleines.

Le débit du vidage doit être suffisamment dimensionné.

Une fonction optimale est seulement garantie en combinaison avec de Hansgrohe High Flow thermostats.

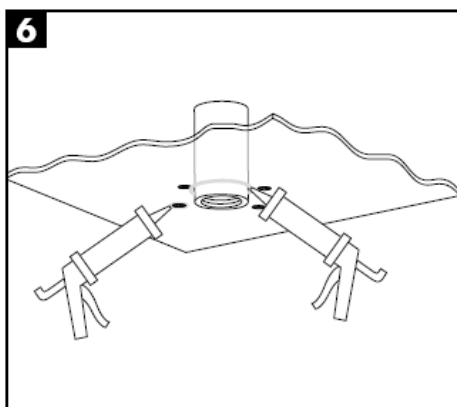
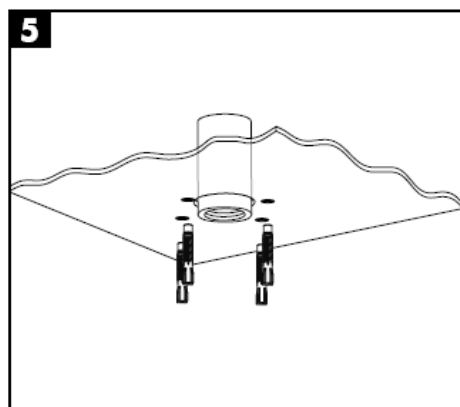
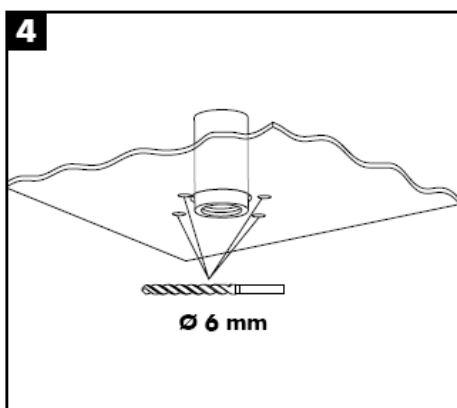
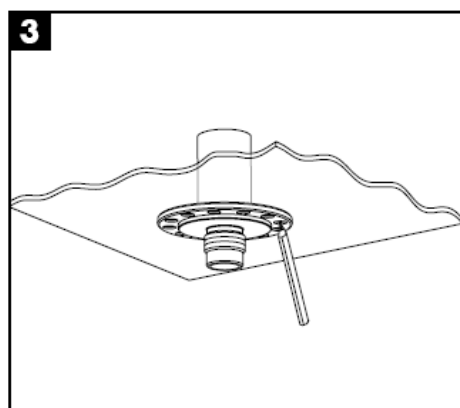
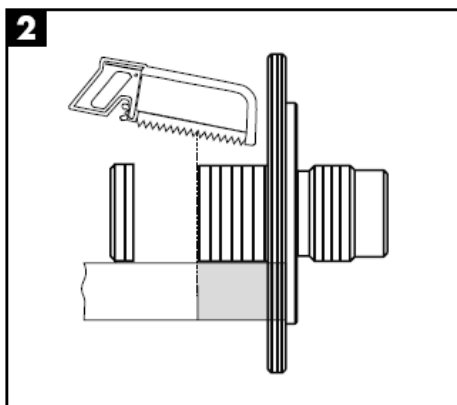
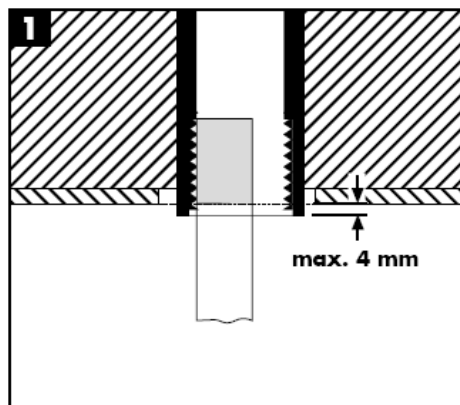

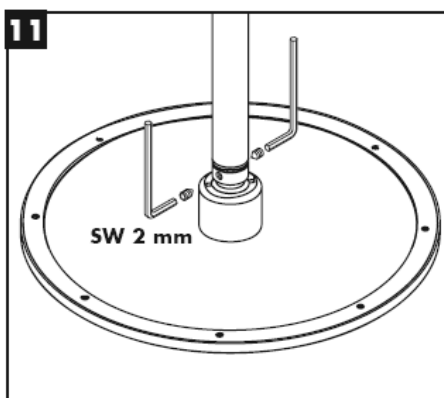
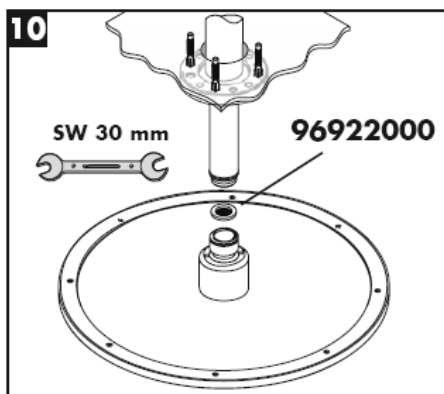
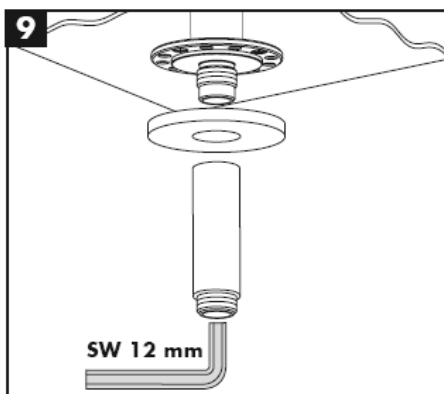
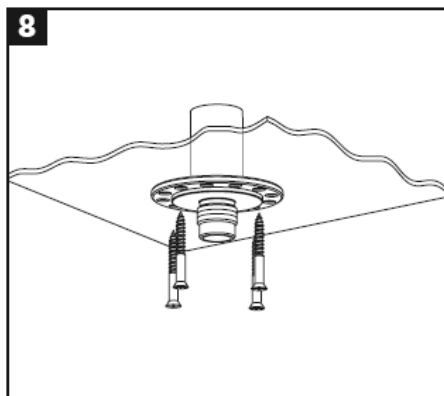
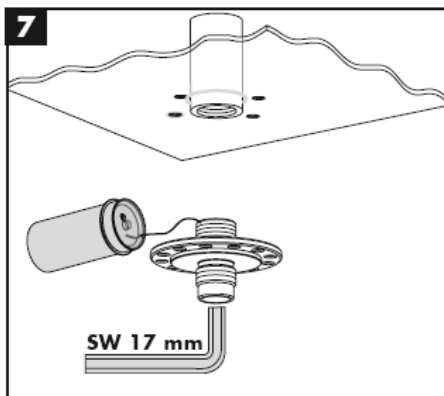

Le joint à filtre fourni avec la pomme de douche à main doit être installé afin de retenir des impuretés du système de conduites. Ceux-ci pourraient influencer le fonctionnement de ce produit et même endommager des pièces mobiles. Des réclamations à la suite de l'usage de la pomme de douche sans joint-tamis de hansgrohe ne peuvent pas faire partie de notre garantie.

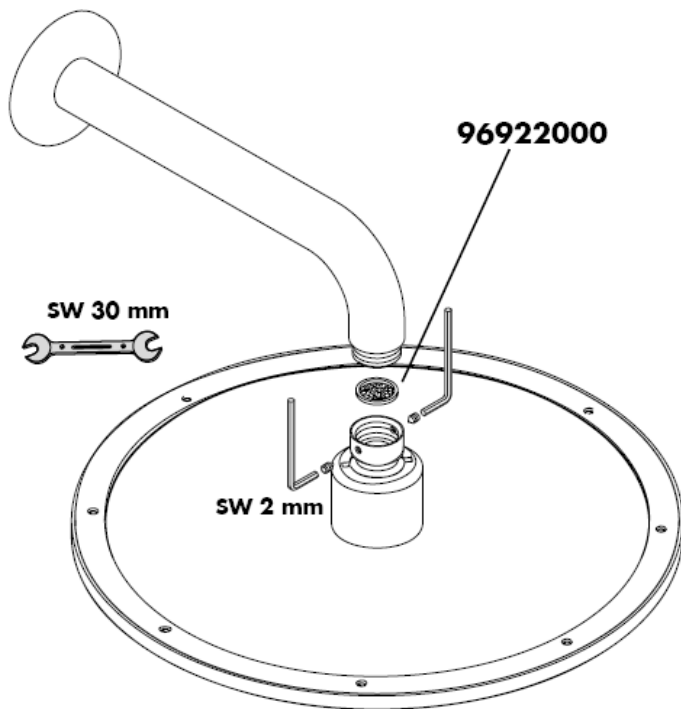

Montage

Attention! La robinetterie doit être installée, rincée et contrôlée conformément aux normes valables!

Réglage

Une correction est nécessaire, lorsque la température mesurée au point de vidange diffère de la température de réglage du thermostat.

Dans ce cas, faites la démarche suivante:

Tourner la poignée thermostatique jusqu'à ce que vous obteniez une température de 38 °C au point de vidange. Dévisser la vis de la poignée, tourner la poignée jusqu'à la marque de 38 °C, remettre la poignée et vissez la vis de la poignée (voir page 22).

Limitation de température

La plage de température est limitée à 38 °C par le verrou de sécurité. Quand on désire une température supérieure, on peut dépasser 38 °C en appuyant sur le bouton de sécurité.

Safety Function

Grâce à la fonction Safety, il est possible de pré-régler la température maximale par exemple max. 42 °C souhaitée. voir pages 21.

Informations techniques

Pression de service autorisée: max. 1 MPa
 Pression de service conseillée: 0,1 – 0,5 MPa
 Pression maximum de contrôle: 1,6 MPa
 (1 MPa = 10 bar = 147 PSI)
 Température max. d'eau chaude: max. 80° C
 Température recommandée: 65° C
 Débit: ca. 58 l/min 0,3 MPa

Entretien

Les thermostats n'ont pas besoin d'un entretien spécial. Les clapets anti-retour doivent être examinés régulièrement conformément à la norme EN 1717 ou conformément aux dispositions nationales ou régionales quant à leur fonction (au moins une fois par an).

Contrôler par la même occasion les filtres qui se trouvent sur la cartouche thermostatique MTC (6.1). Après le montage de la cartouche thermostatique MTC (6) vérifier obligatoirement la température au point de vidange, comme il est décrit pour le réglage. Vérifier absolument auparavant si l'alimentation d'eau chaude et la température maximale se trouvent au point de vidange.

Pour assurer le mouvement facile de l'élément thermostatique, le thermostat devrait être placé de temps en temps en position très chaude et très froide.

Pièces détachées voir pages 3

1	poignée thermostatique	38391000
2	rosace	96452000
3	douille	97439000
4	vis du support	96454000
5	support de rosace	96447000
6	cartouche thermostatique	96633000
7	filter	97367000
8	clapet anti-retour	96655000
9	jeu de rallonge 25 mm	13595000
10	jeu de rallonge 25 mm	13596000

Français

Dysfonctionnement	Origine	Solution
Pas assez d'eau	-Pression d'alimentation insuffisante -Filtre de l'élément thermostatique encrassé -Joint-filtre de douchette encrassé	-Contrôler la pression -Nettoyer les filtres -Nettoyer le joint-filtre entre la douchette et le flexible
Circulation opposée, l'eau chaude est comprimée dans l'arrivée d'eau froide et vice versa avec robinet fermé	-Clapet anti-retour encrassé ou défectueux	-Changez le clapet antiretour
La température à la sortie ne correspond pas à la température de réglage	-Le thermostat n'a pas été réglé -Température d'eau chaude trop basse, pas d'eau froide	-Régler le thermostat -Augmenter la température d'eau chaude entre 42 C et 65 C
Le réglage de la température n'est pas possible	-L'élément thermostatique est encrassé ou entartré -Montez le bloc de fonction à 180	-La pièce de base a une alimentation inversée (l'eau froide doit être à droite et l'eau chaude à gauche) ou elle est montée à l'envers -Bouton à pression du verrouillage de sécurité défectueux
Ressort défectueux	-Nettoyer le ressort ou bien le bouton à pression, le changer éventuellement -Bouton à pression entartré	-Nettoyer le ressort ou bien le bouton à pression, le changer éventuellement -Nettoyer le ressort ou bien le bouton à pression, le changer éventuellement

Classification acoustique et débit

	P-IX	DVGW	SVGW	WRSA	KIWA	ACS	NF
27070000						X	
27418XXX							
28420000						X	
28435XXX						X	

Nettoyage

La propreté en toute simplicité: les dépôts formés sur les buses élastiques en silicone s'éliminent par un simple passage de la main.

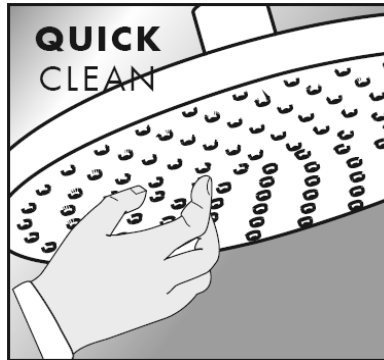

Conseils d'entretien

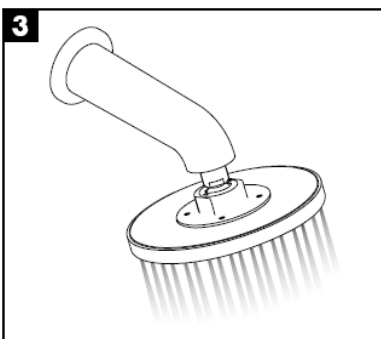
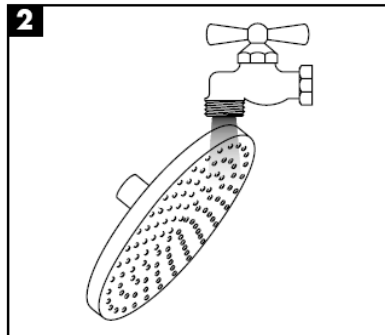
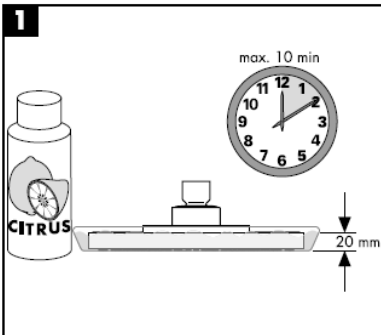

hansgrohe

assembly instructions



27418XXX

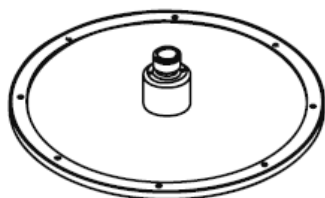

Raindance Royale AIR
28420000

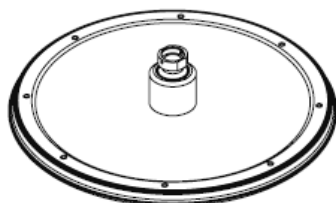

Raindance Royale Classic AIR
28435XXX

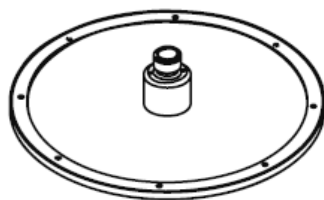

**Raindance Royale
High Flow Set**
27070000

hangrohe

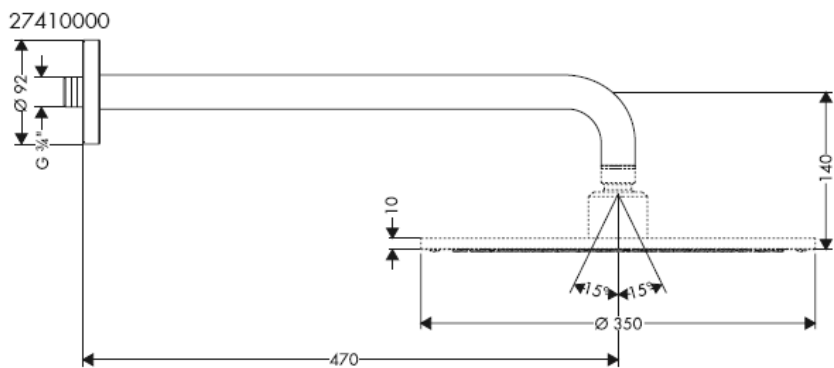
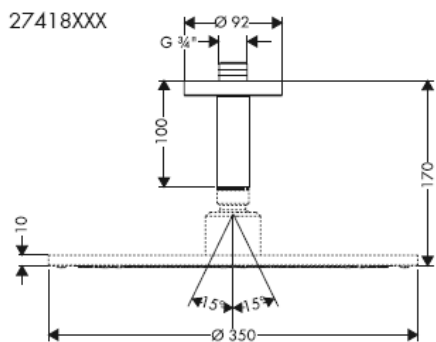
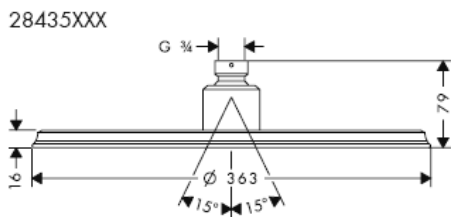
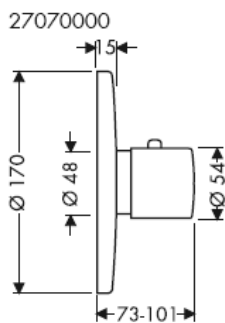
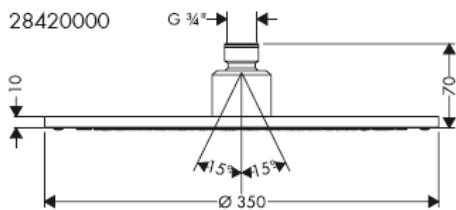

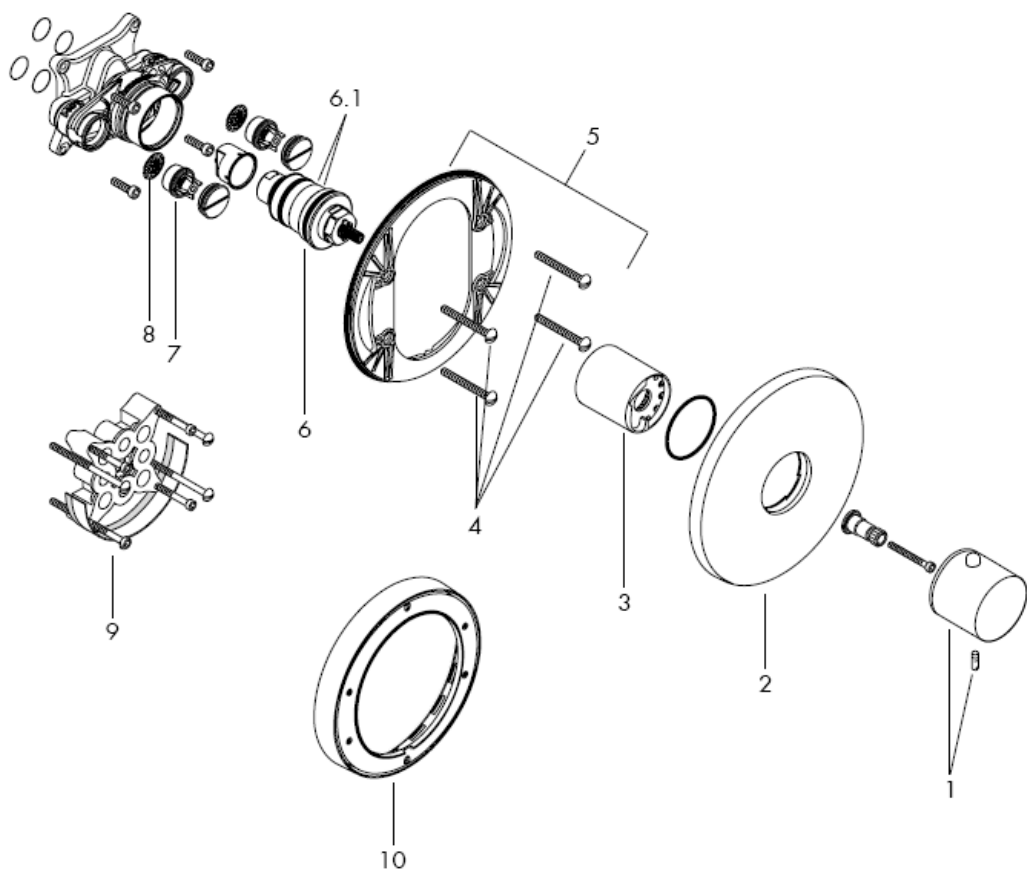

Adjust the dimensions to the tile pattern if required.

Renforcement nécessaire de la paroi

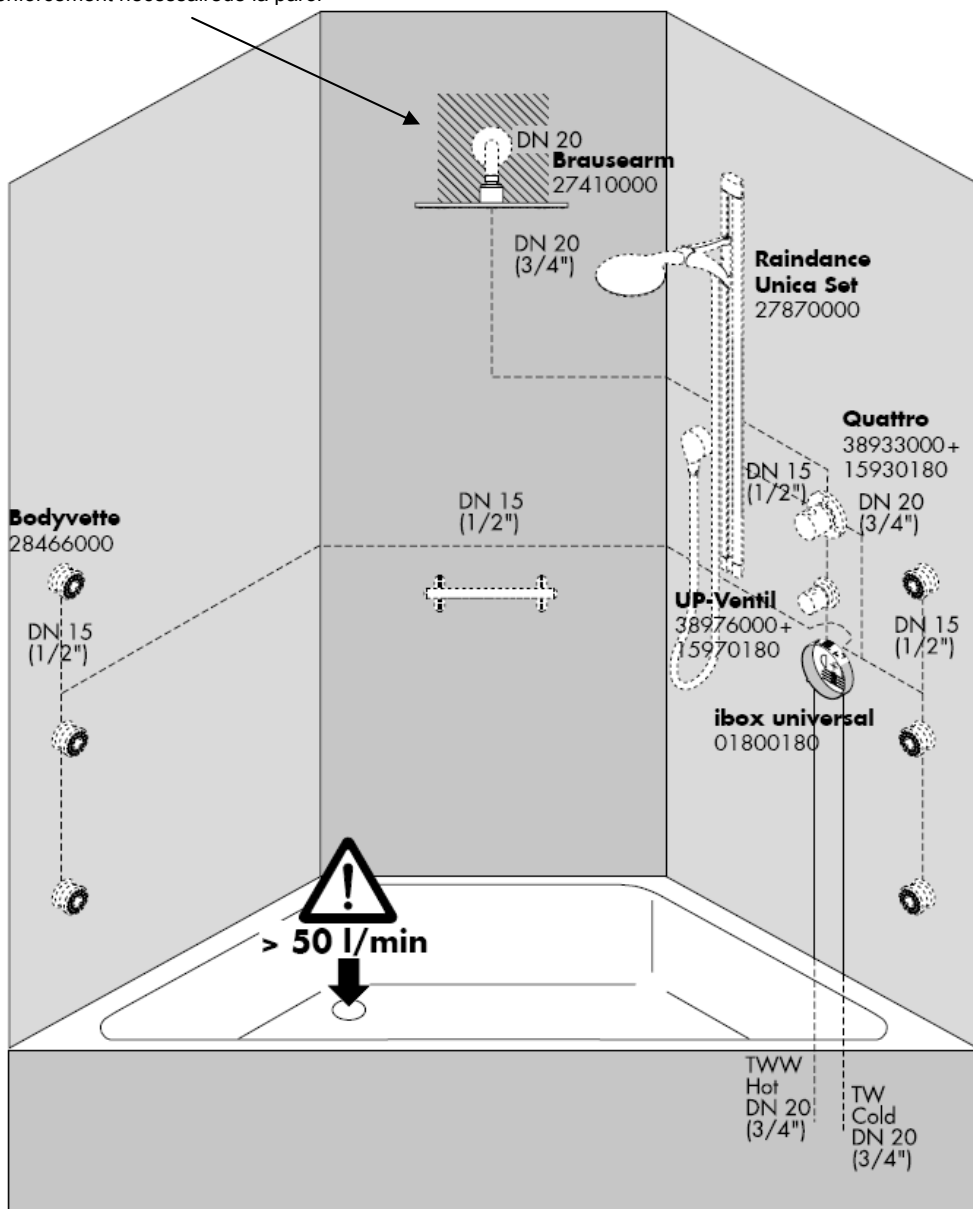

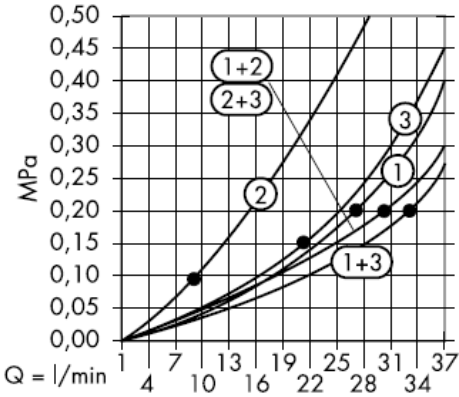

From • the function is guaranteed.

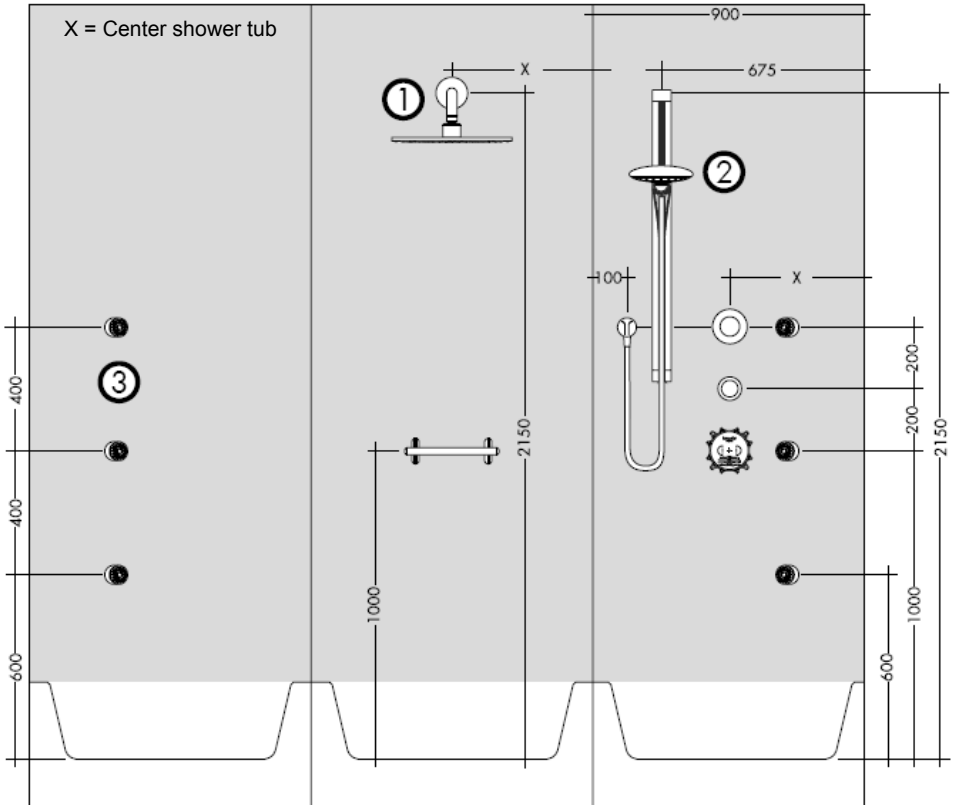

Renforcement nécessaire de la paroi

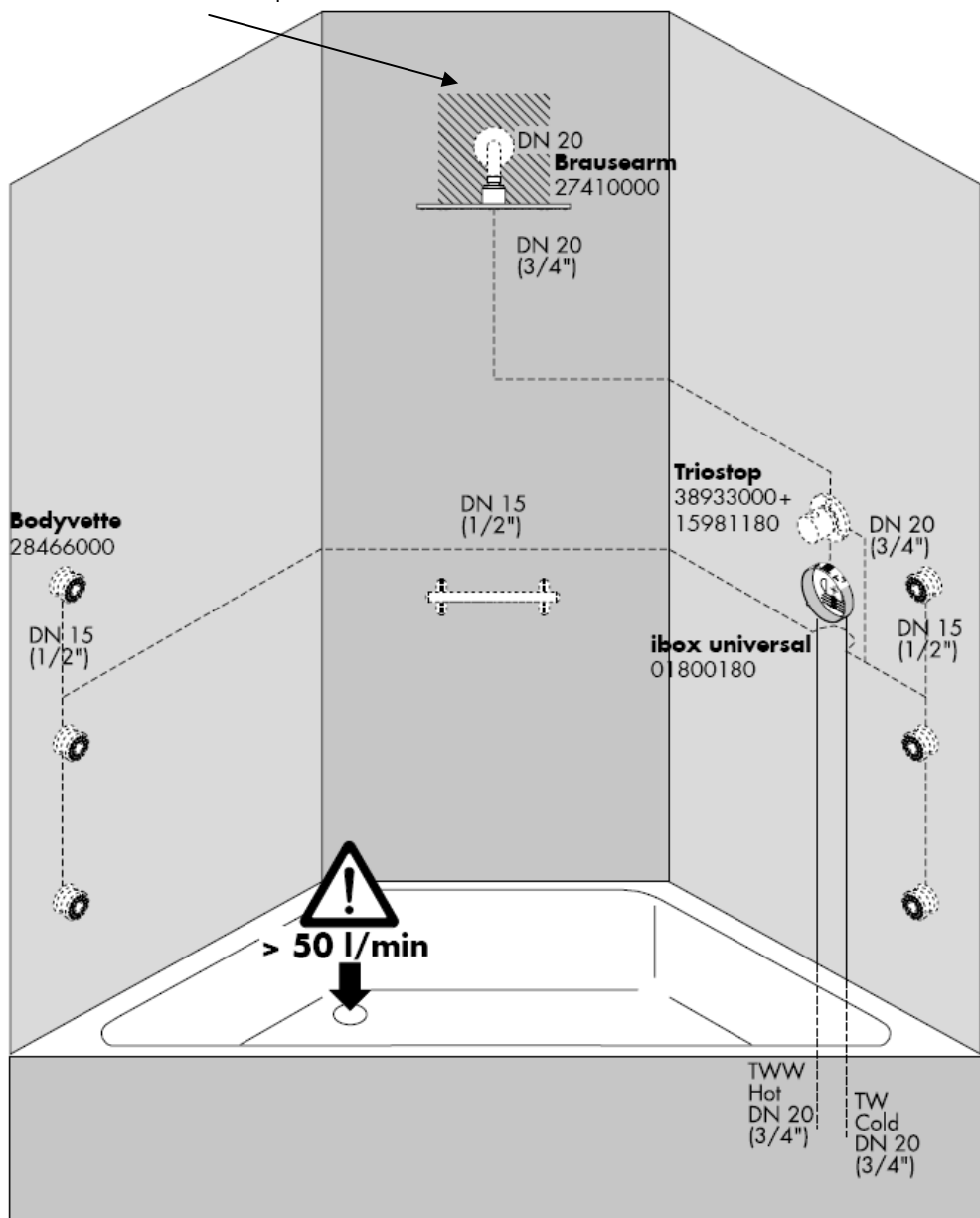

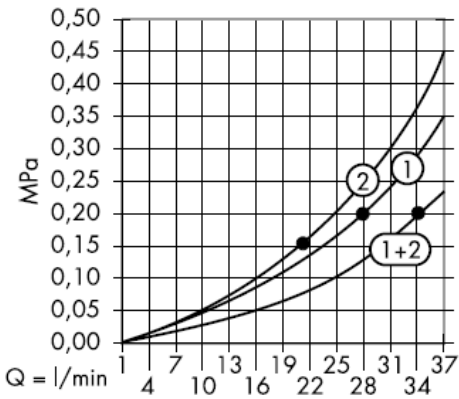

From • the function is guaranteed.

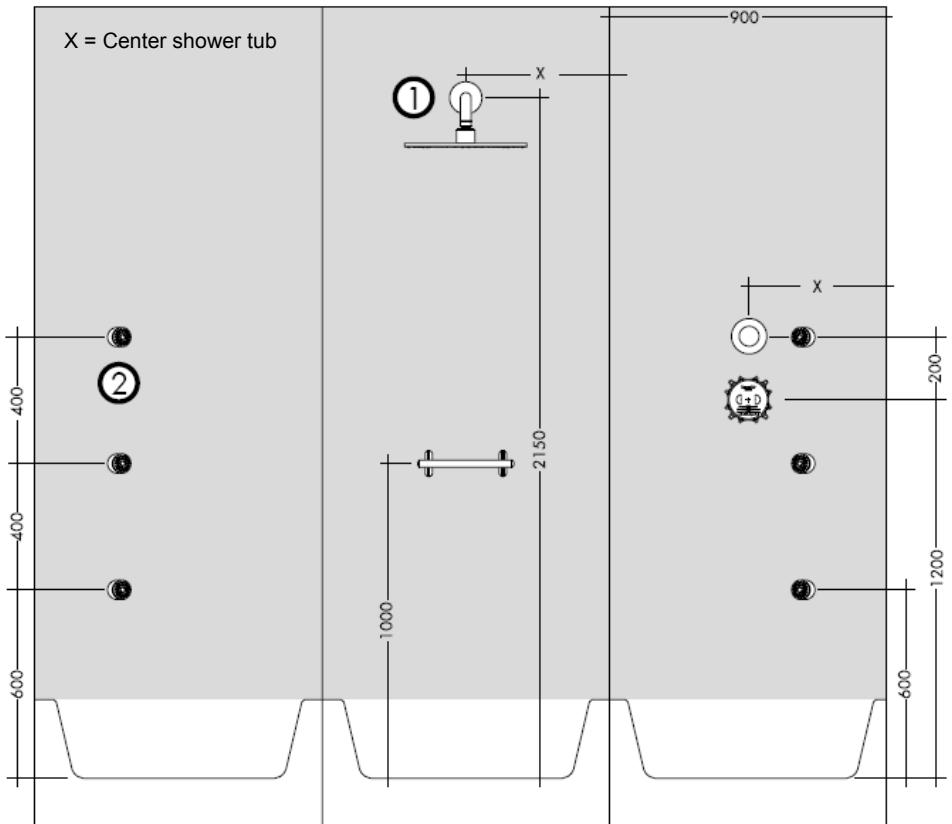

Renforcement nécessaire de la paroi

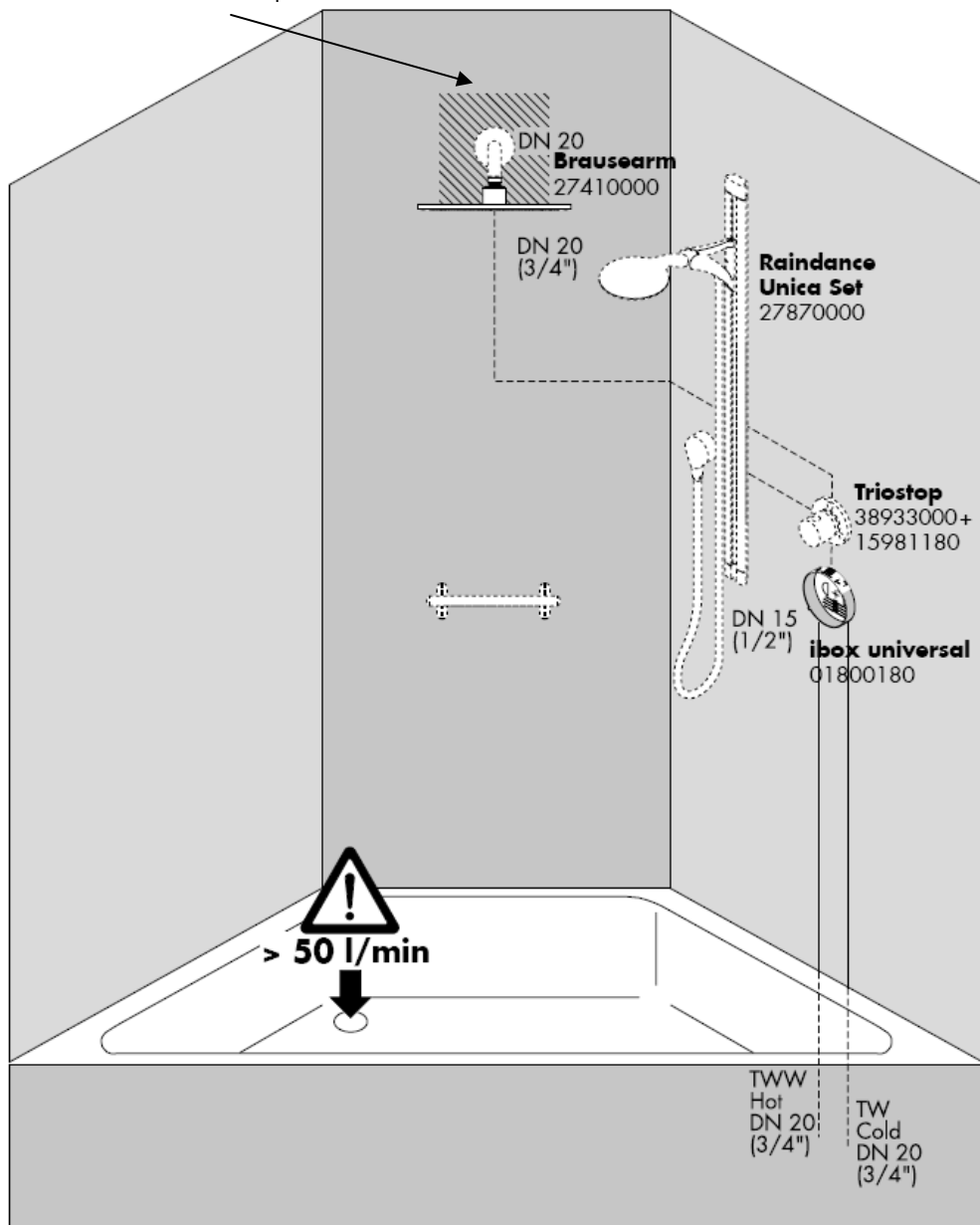

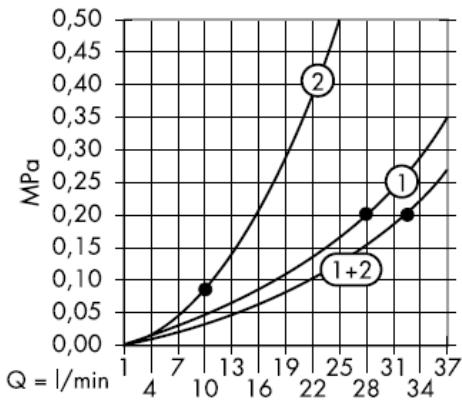

From • the function is guaranteed.

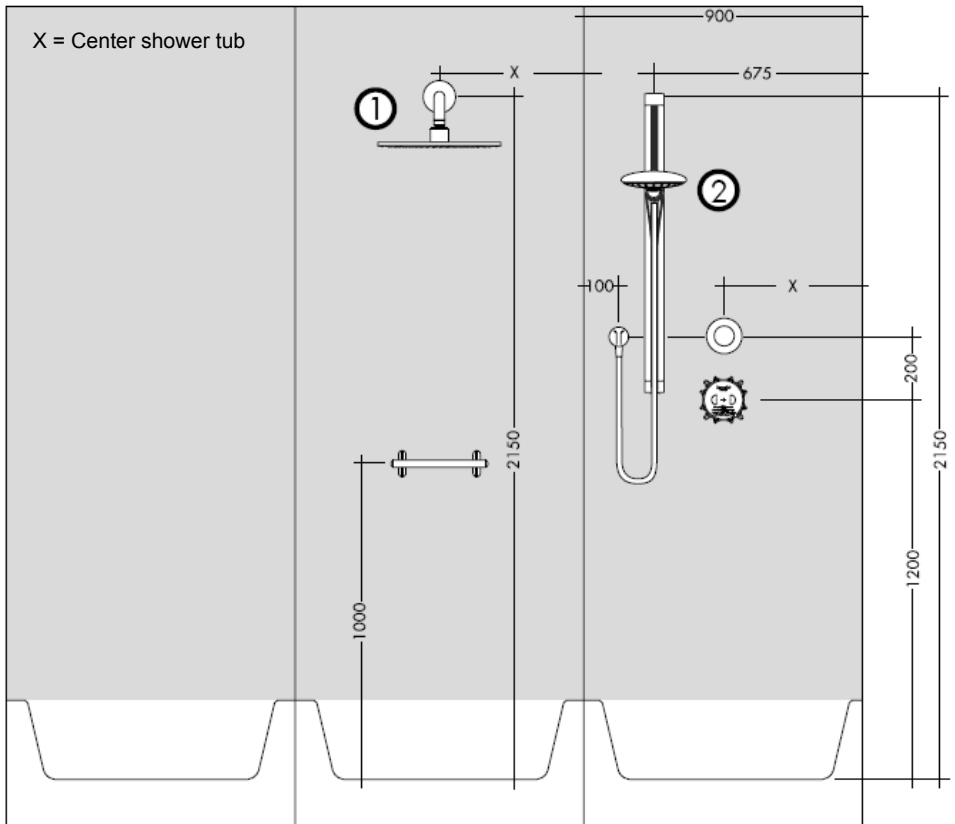

Renforcement nécessaire de la paroi

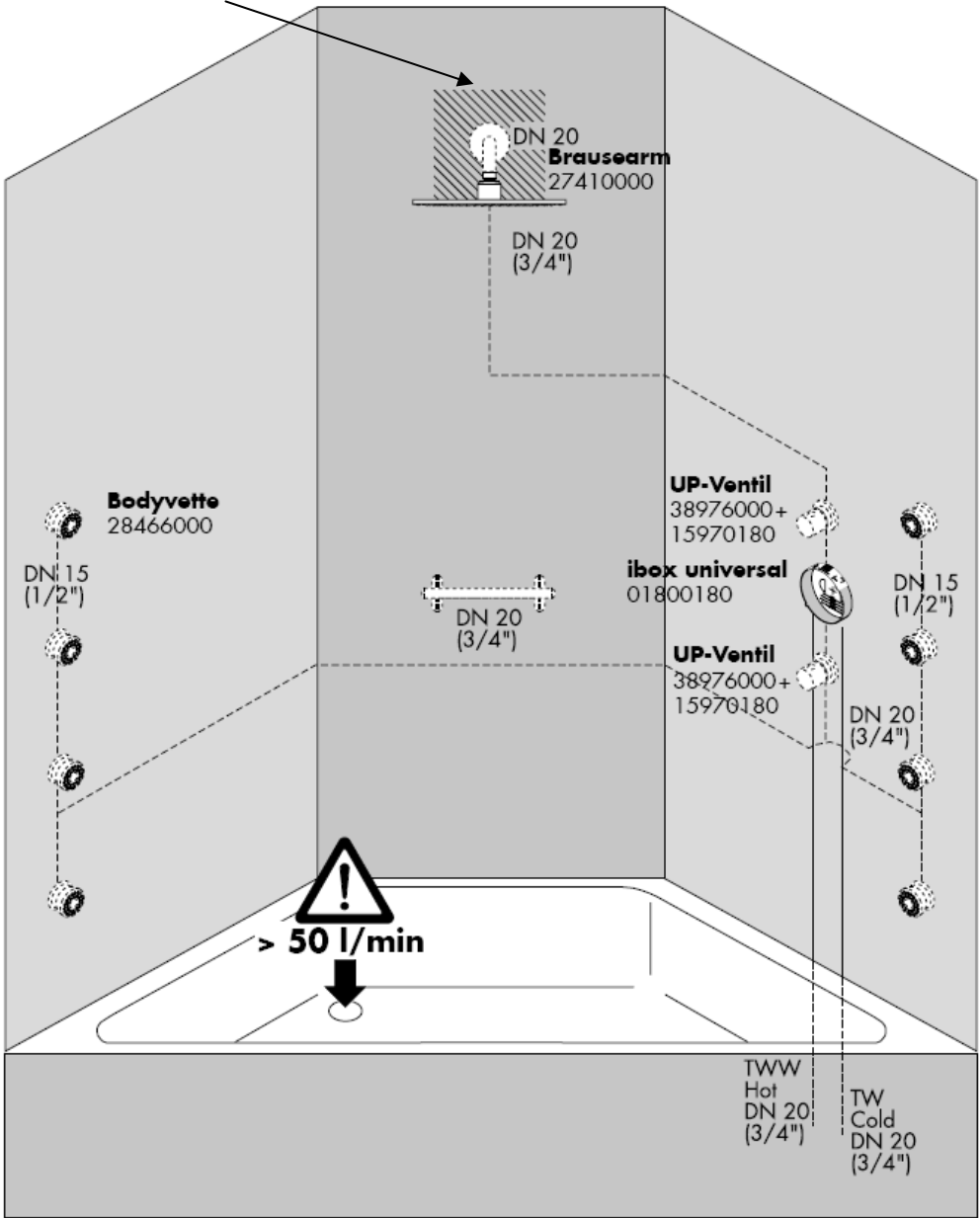

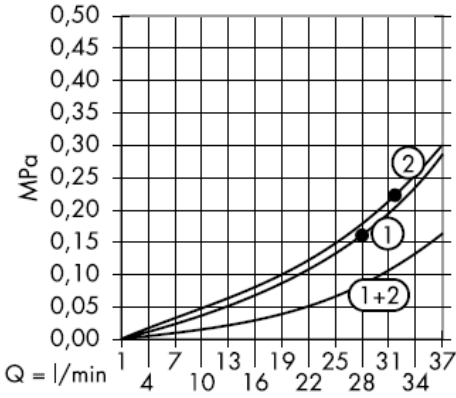

From • the function is guaranteed.

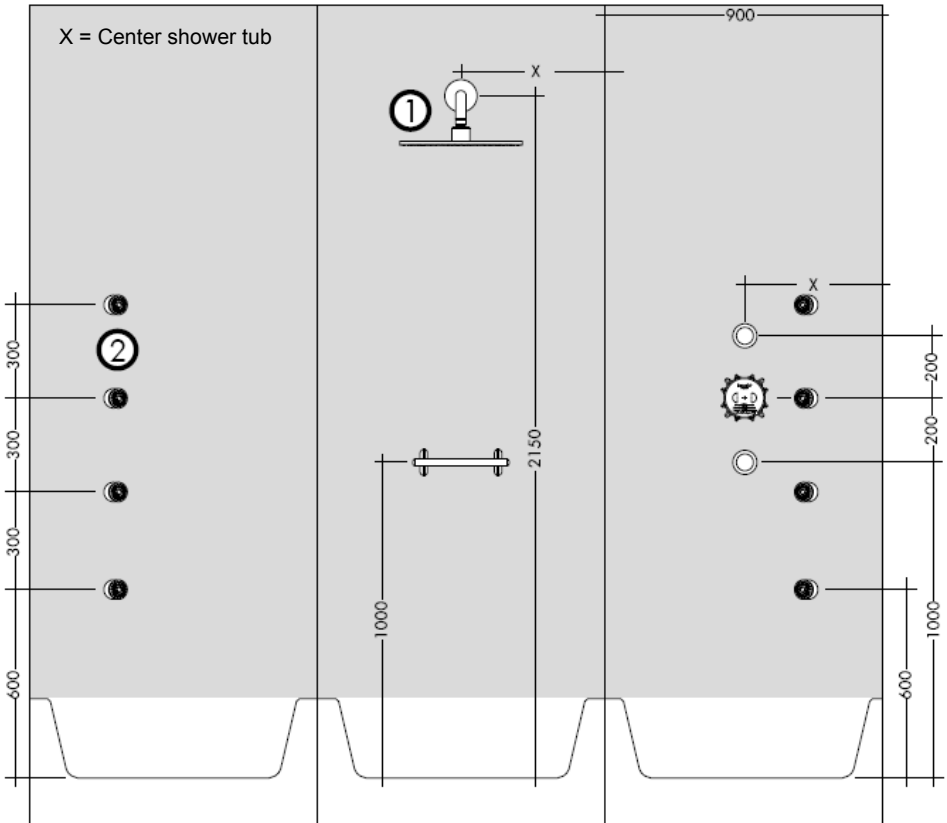

Renforcement nécessaire de la paroi

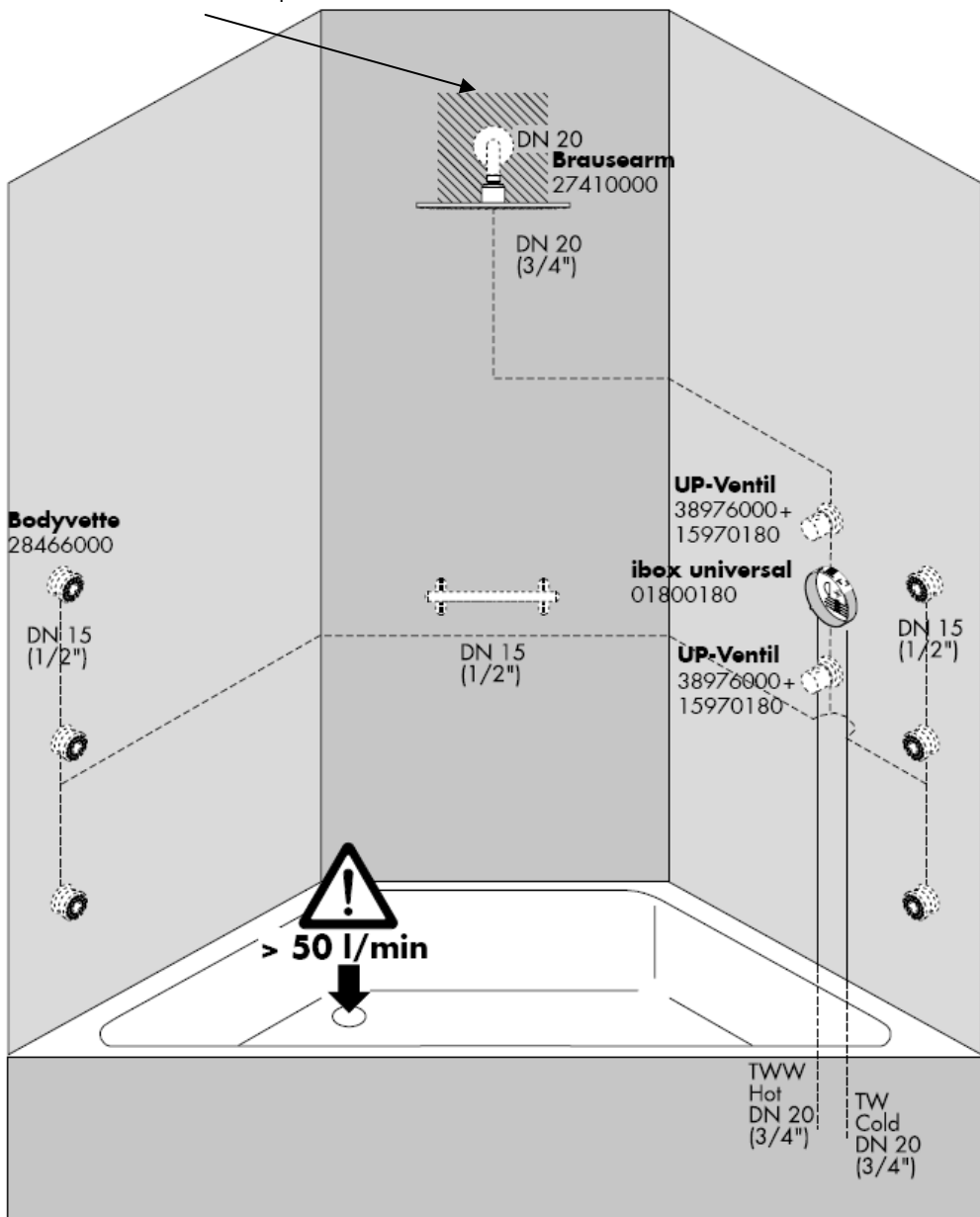

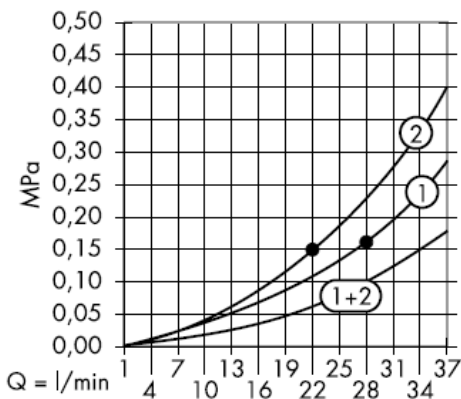

From • the function is guaranteed.

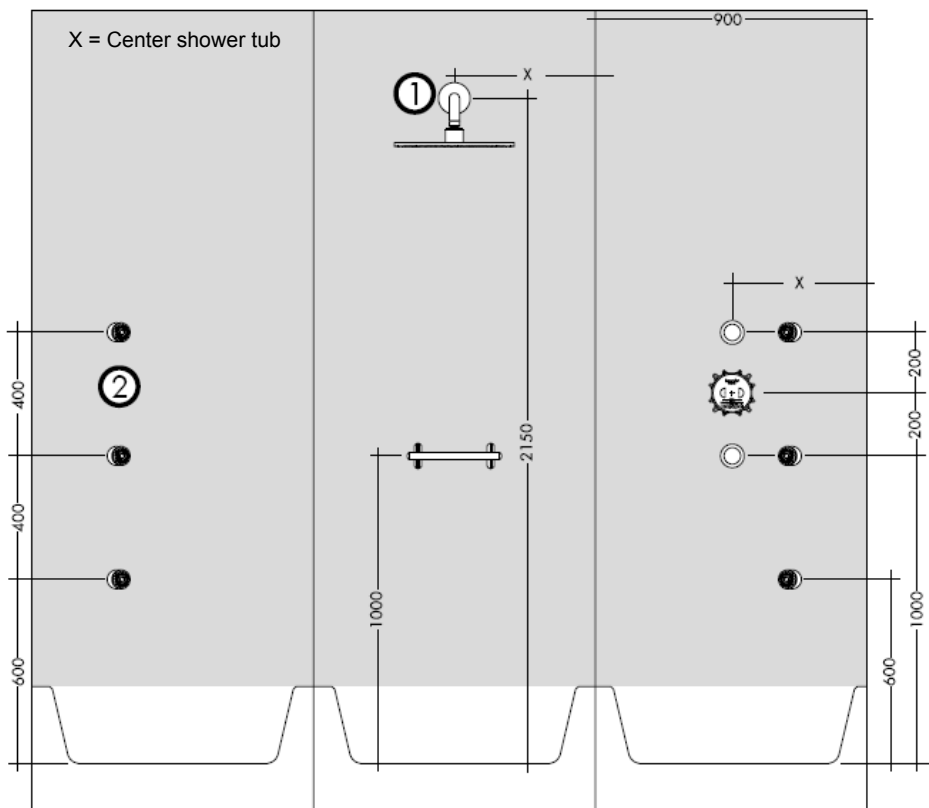

Renforcement nécessaire de la paroi

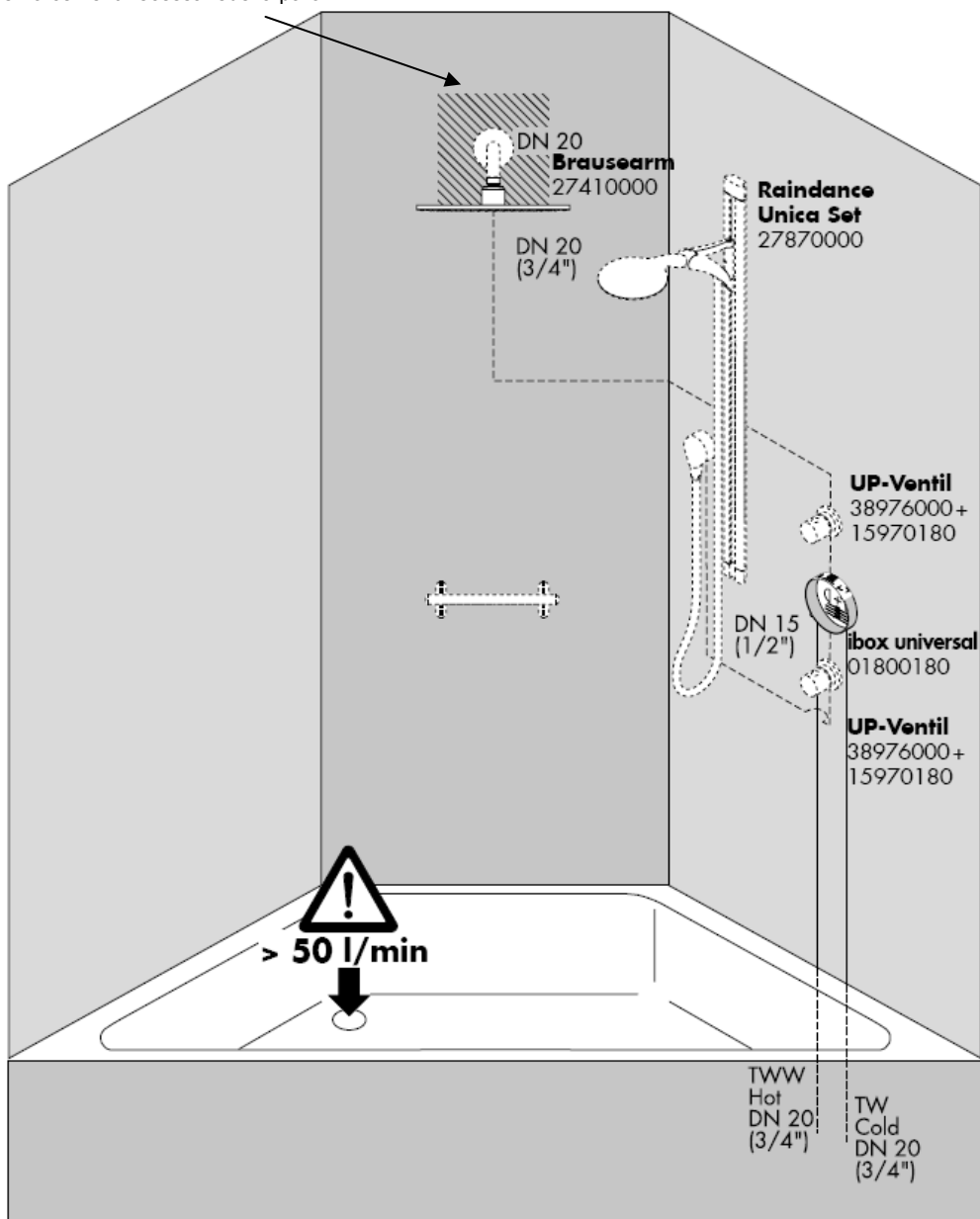

From • the function is guaranteed.

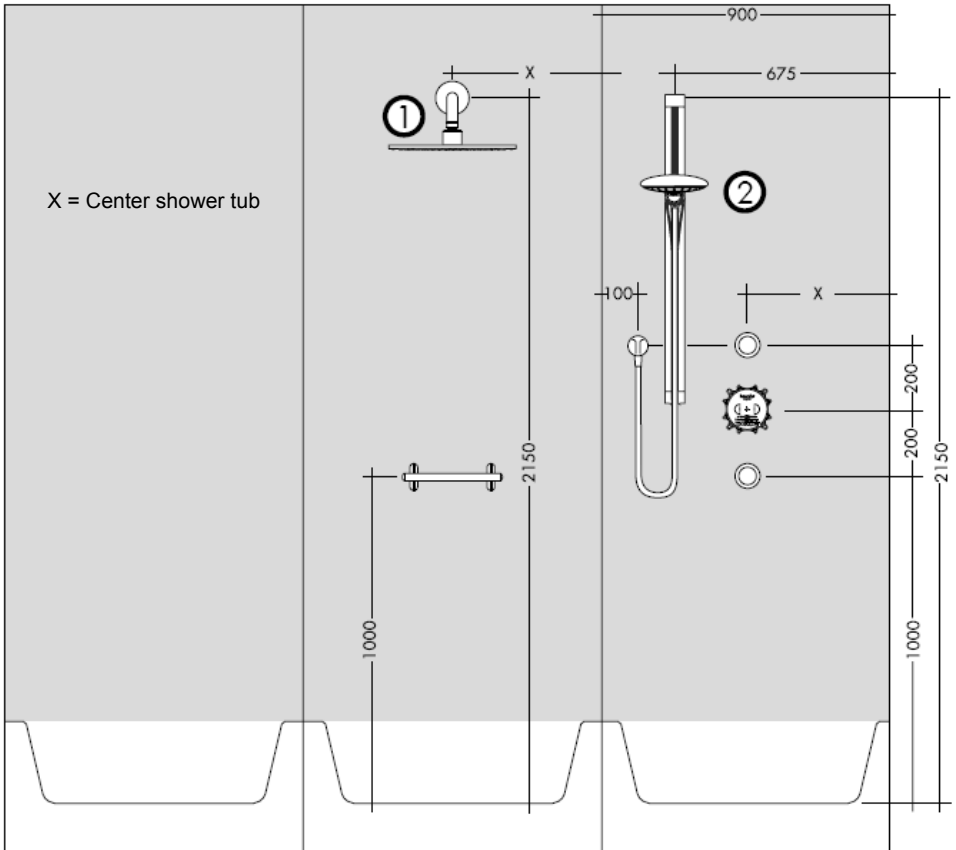
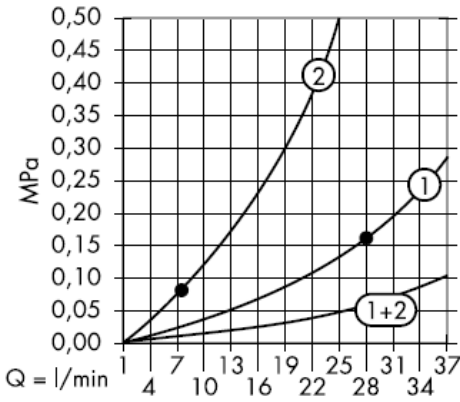

Renforcement nécessaire de la paroi

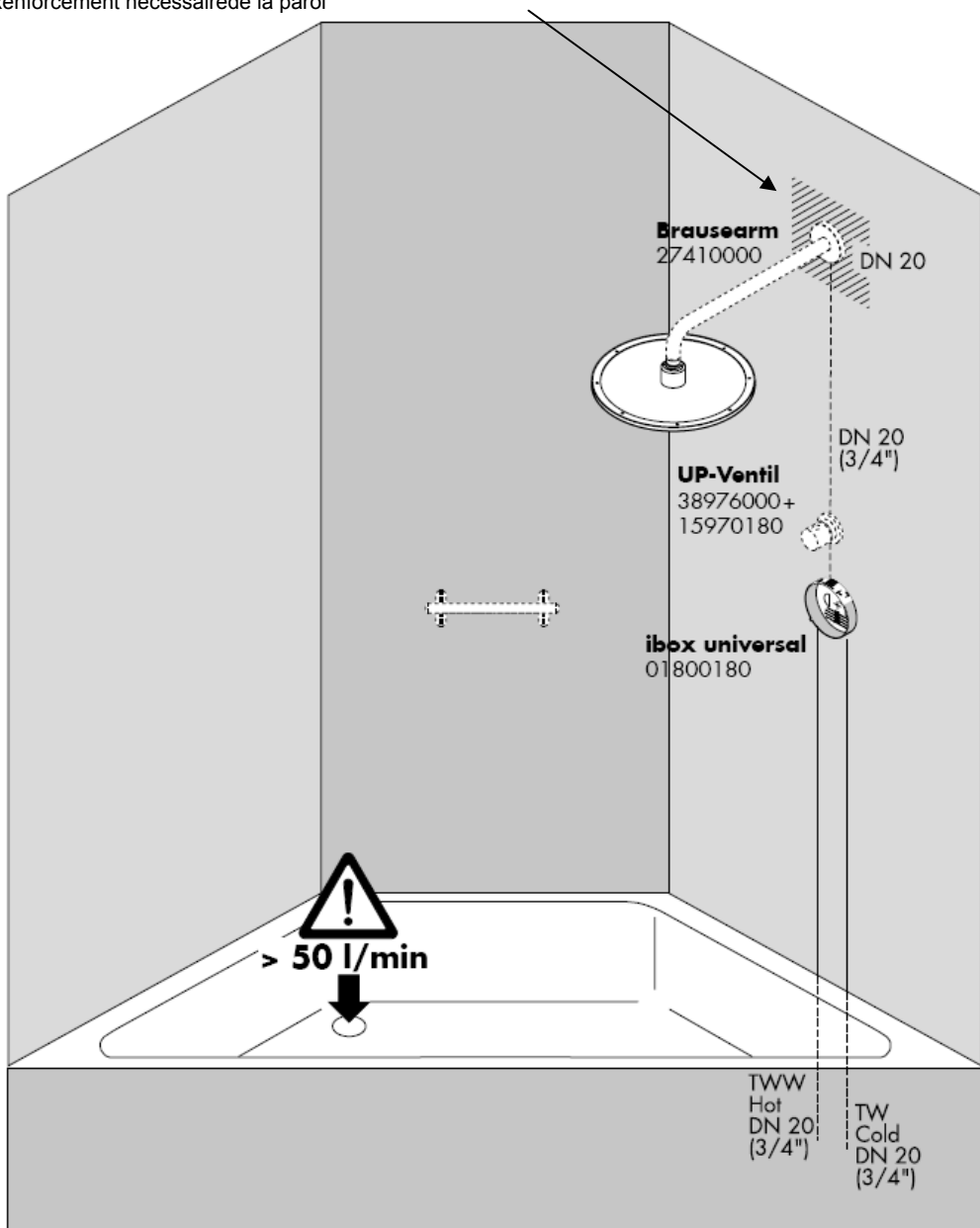

From • the function is guaranteed.

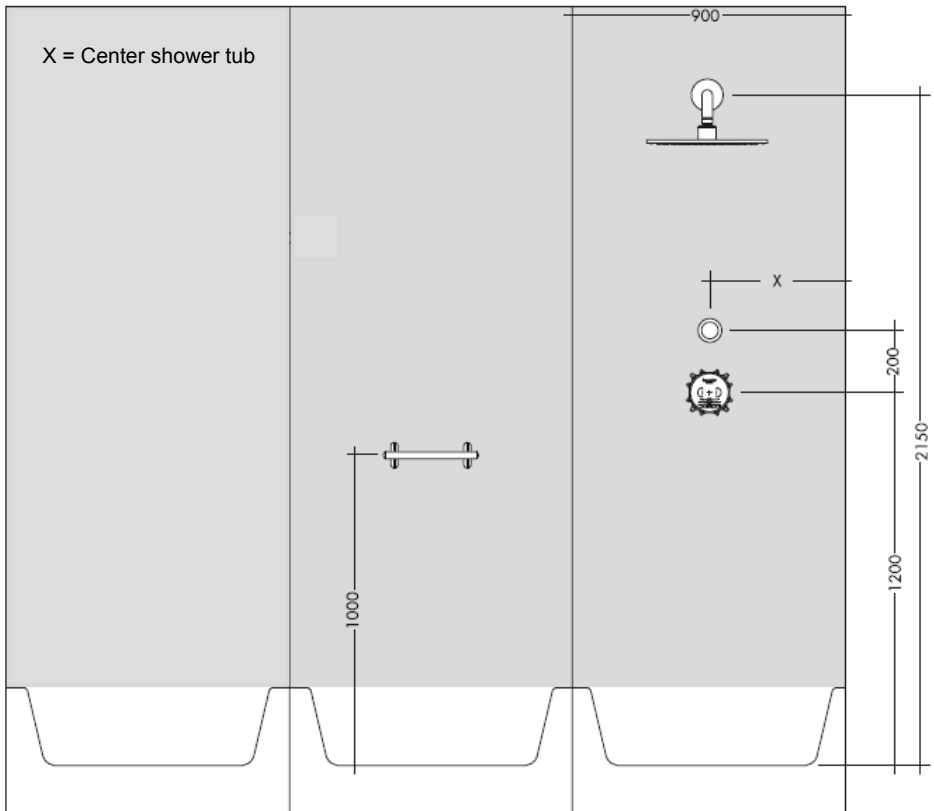
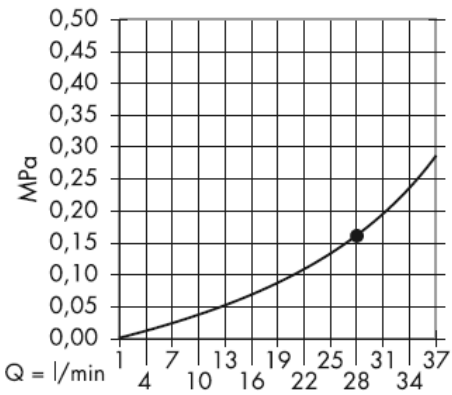

Renforcement nécessaire de la paroi

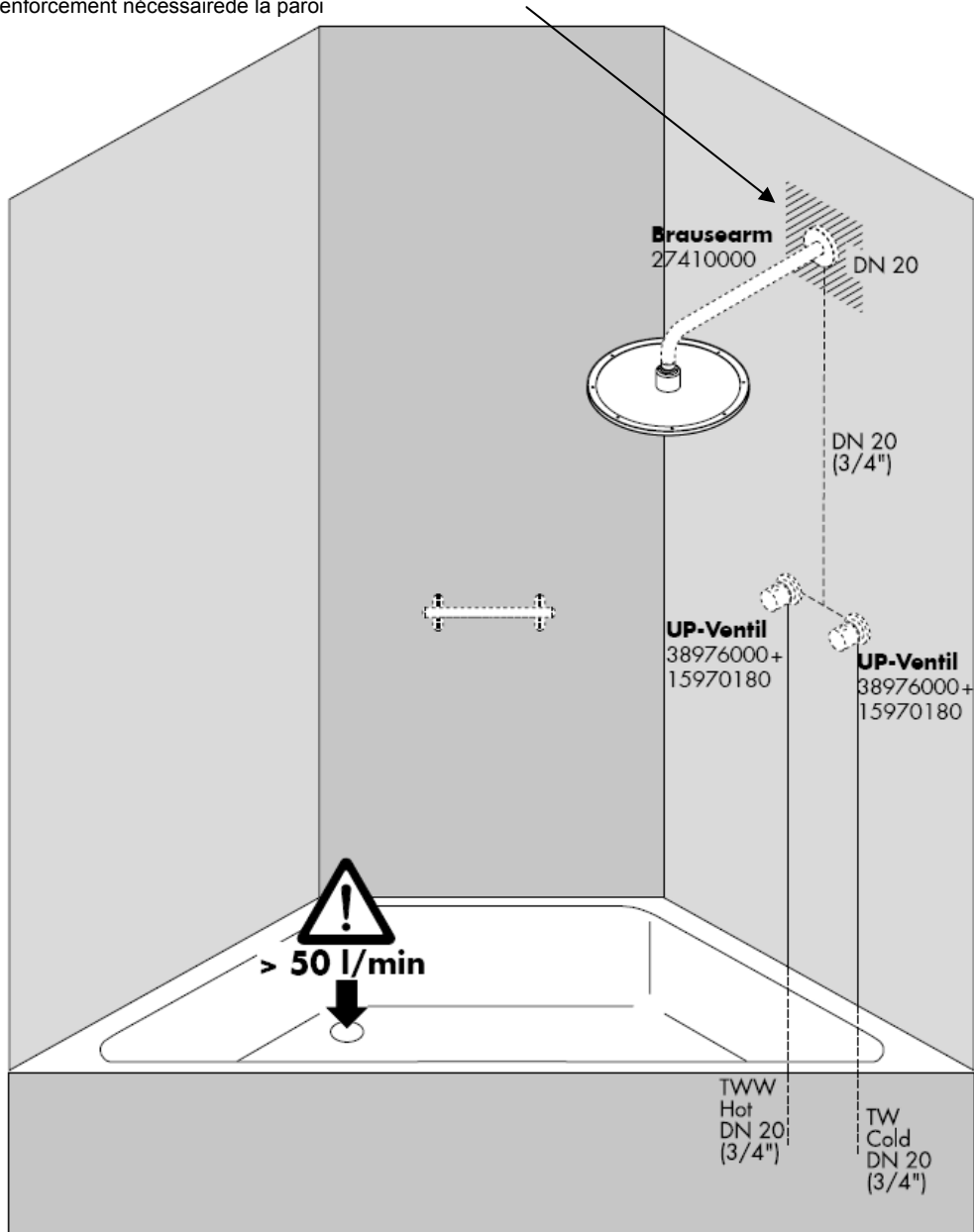

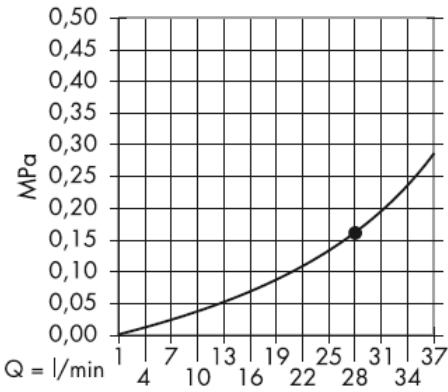

From • the function is guaranteed.

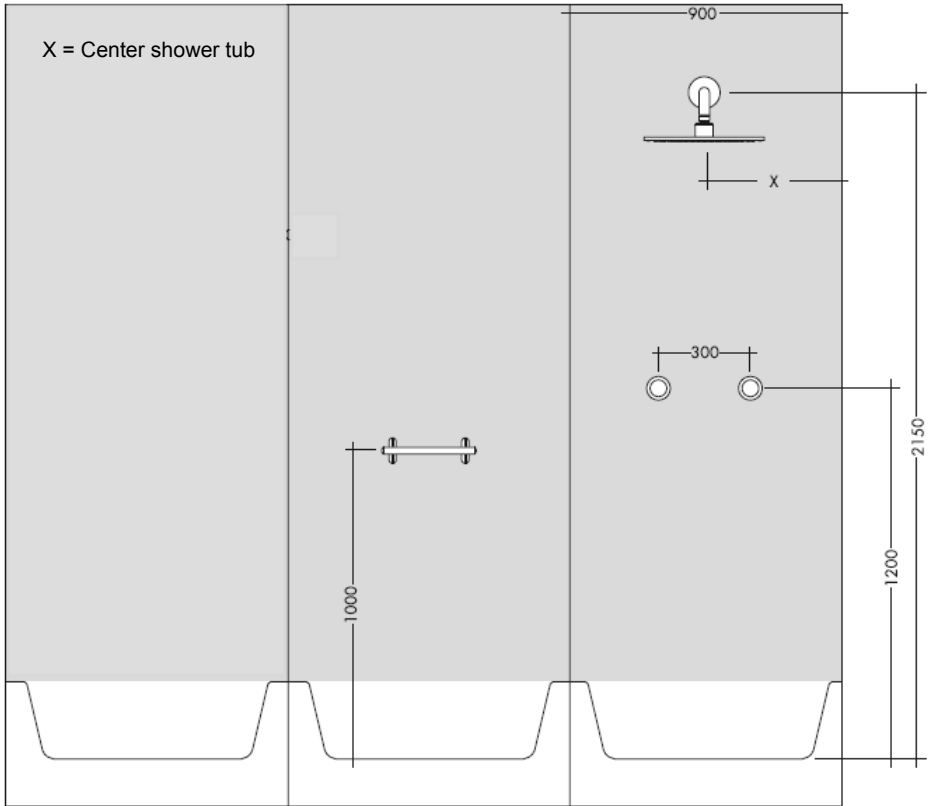

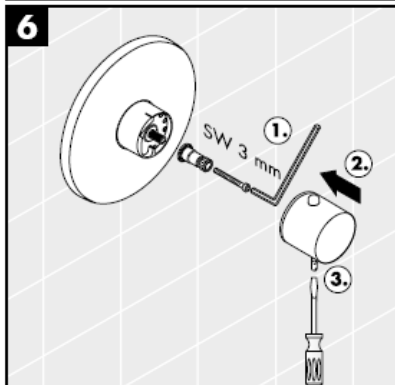
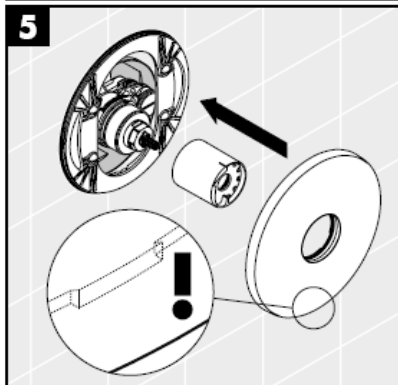
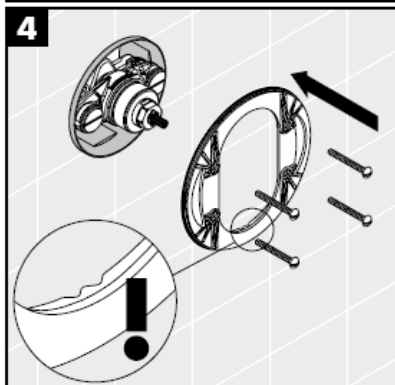
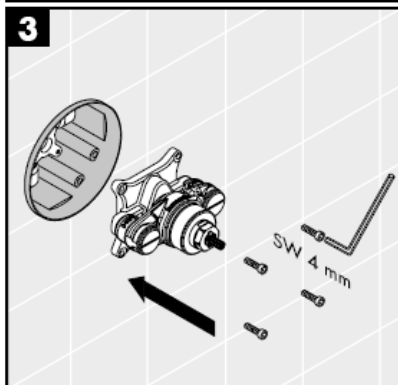
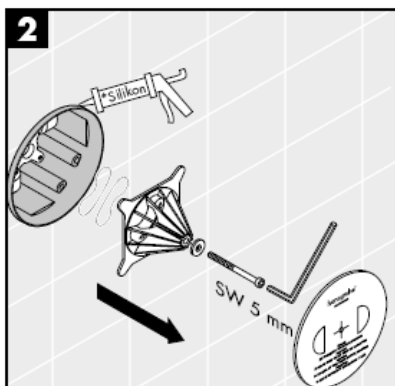
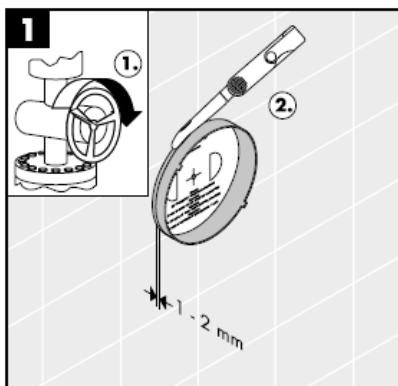

Silicone (free from acetic acid!)

The desired maximum temperature for example max. 42 °C can be pre-set thanks to the safety function.

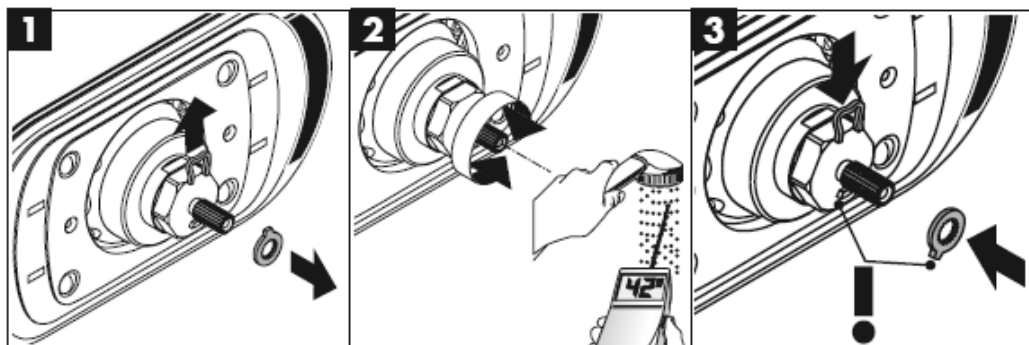

Adjustment

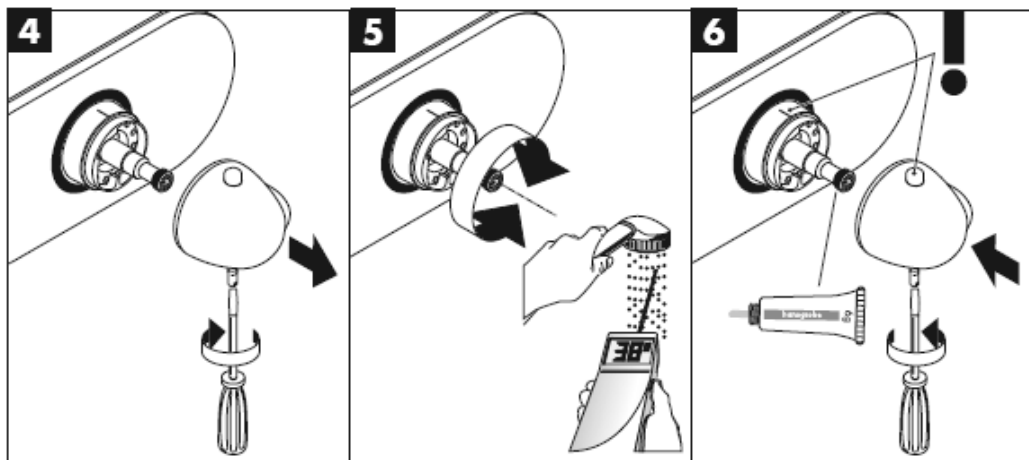



If the shower is in function, it has a weight of approximately 10 kg together with the shower arm. So only use fastening material suitable for the brickwork! The enclosed screws and dowels are only for solid brickwork.

Only use fastening material suitable for the brickwork! The enclosed screws and dowels are only for solid brickwork.

The performance of the waste must be of sufficient size.

Optimal functioning is only guaranteed with the combination of Hansgrohe High Flow thermostats.

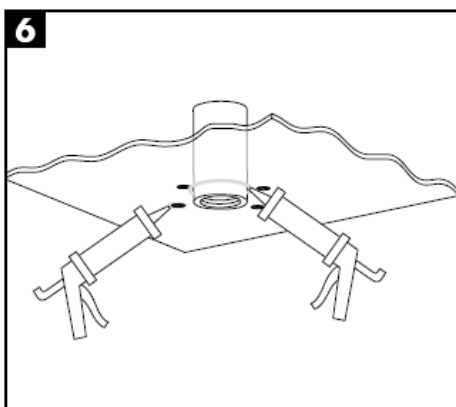
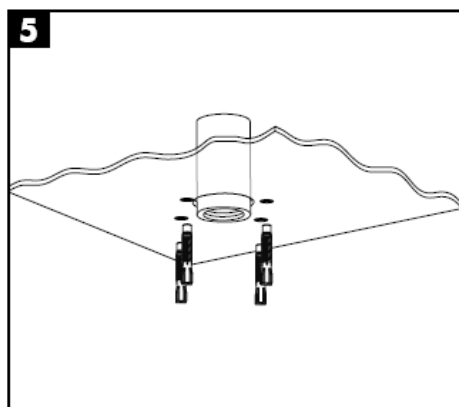
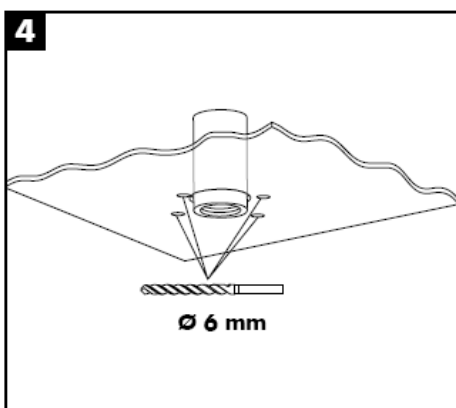
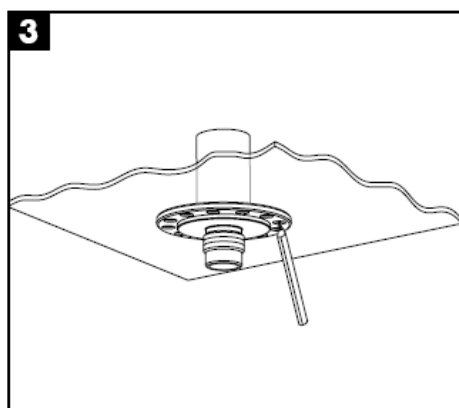
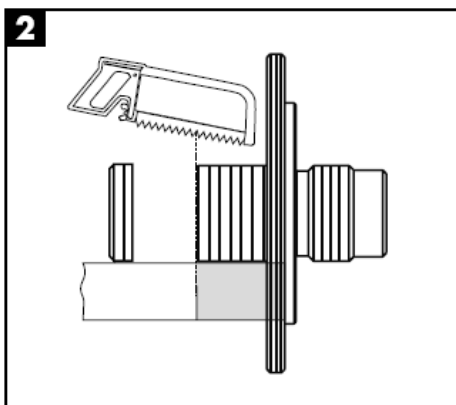
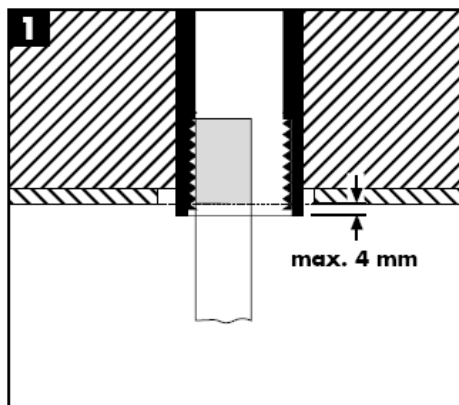

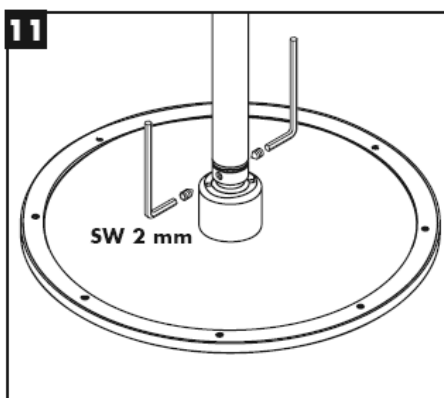
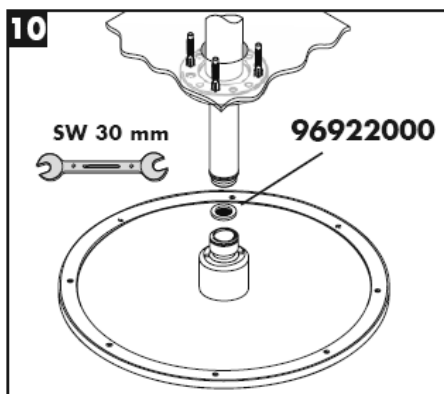
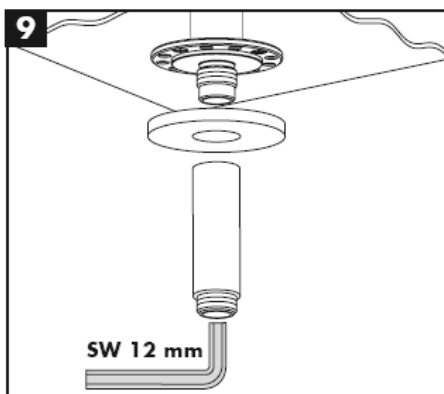
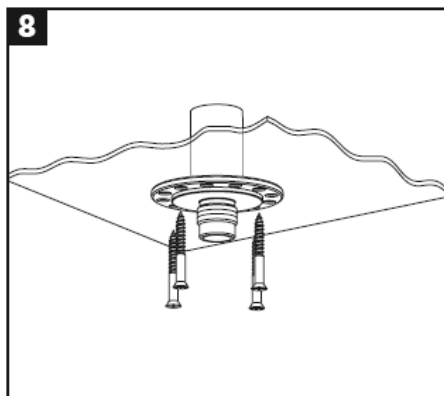
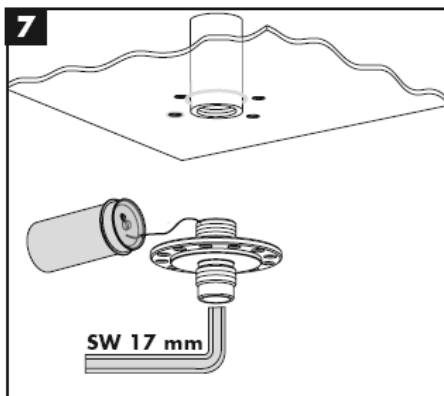

The mesh washer must be insert to protect the overhead shower against incoming dirt by pipework. Incoming dirt leads to defects or/and can damage parts of the shower; such caused faults voids all liability and guarantee claims.

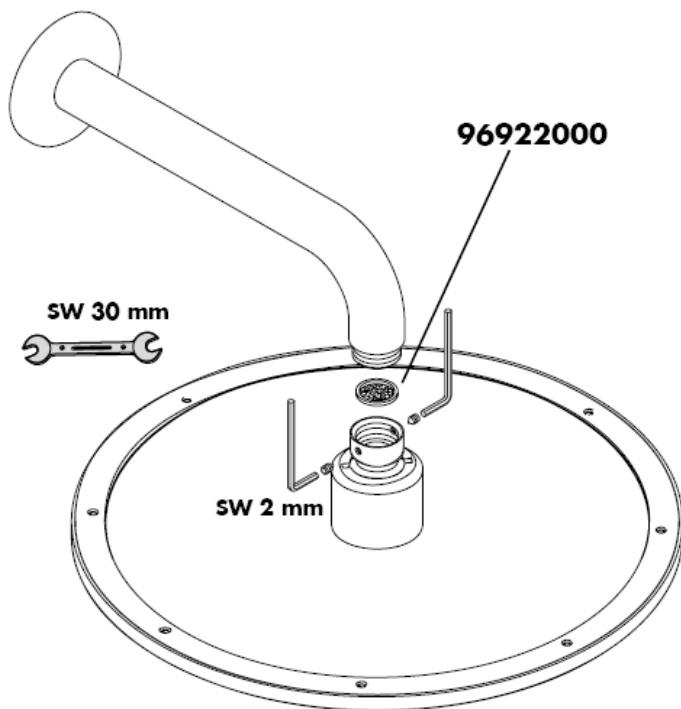

Assembly

Important! The fitting must be installed, flushed and tested after the valid norms!

Adjustment

Correction is necessary if the temperature measured at the take off point differs from the temperature set on the scale. To adjust temperature proceed as follows: Turn the setting knob until water at a temperature of 38 °C comes out of the outlet. Loosen screw of setting knob. Remove setting knob and turn to the 38 °C position. Attach setting knob again and tighten the screw (please see page 22).

Temperature limitation

The temperature is limited by the safety check to 38 °C (100 °F). If a higher temperature is required, it is possible to override the safety stop by depressing the safety button.

Safety Function

The desired maximum temperature for example max. 42 °C can be pre-set thanks to the safety function. see page 21.

Technical Data

Operating pressure: max. 1 MPa
 Recommended operating pressure: 0,1 – 0,5 MPa
 Test pressure: 1,6 MPa
 (1 MPa = 10 bar = 147 PSI)
 Hot water temperature: max. 80° C
 Recommended hot water temp.: 65° C
 Rate of flow: ca. 5.8 l/min 0,3 MPa

Maintenance

There is no special maintenance for thermostats. The non return valves must be checked regularly according to DIN EN 1717 in accordance with national or regional regulations (at least once a year). At this time, please also check the filter (6.1) situated on the MTC-thermo-element (6). After assembling the MTC-thermo-element, it is necessary to check the water temperature at the take off point as described under the headline „adjustment“. Before the adjustment, please check, if the warm water supply is activated and the maximum temperature of the warm water is available at the take off point.

To guarantee the smooth running of the thermostat, it is necessary from time to time to turn the thermostat from total hot to total cold.

Spare parts see page 3

1	handle for thermostat	38391000
2	flange	96452000
3	sleeve	97439000
4	fixing screw	96454000
5	sub plate	96447000
6	thermostat cartridge	96633000
7	filter	97367000
8	non return valve	96655000
9	extension 25 mm	13595000
10	extension 25 mm	13596000

English

Fault	Cause	Remedy
Insufficient water	-Supply pressure inadequate -Regulator filter dirty -Shower filter seal dirty	-Check water pressure (If a pump has been installed check to see if the pump is working). -Clean filters -Clean filter seal between shower and hose
Crossflow, hot water being forced into cold water pipe, or vice versa, when mixer is closed	-Backflow preventers dirty or leaking	-Exchange non return valves
Spout temperature does not correspond with temperature set	-Thermostat has not been adjusted -Hot water temperature too low	-Adjust thermostat -Increase hot water temperature to 42 °C to 65 °C
Temperature regulation not possible	-Temperature regulator dirty or calcified -Install function block turned through 180	-For new installations: basic body incorrectly connected (should be: cold right, hot left) or installed with 180° rotation -Safety stop button not operating
Spring defective	-Clean spring and/or button, exchange if necessary -Button calcified	-Clean spring and/or button, exchange if necessary -Clean spring and/or button, exchange if necessary

Test certificate

	P-IX	DVGW	SVGW	WRSA	KIWA	ACS	NF
27070000						X	
27418XXX							
28420000						X	
28435XXX						X	

Cleaning

Just clean: simply rub over the spray nozzles to remove lime scale.

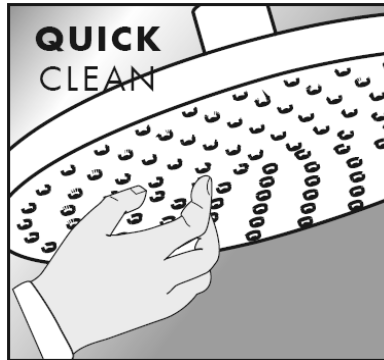

Cleaning instructions

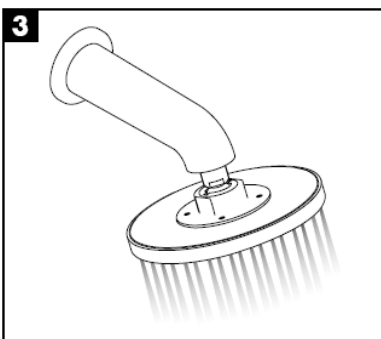
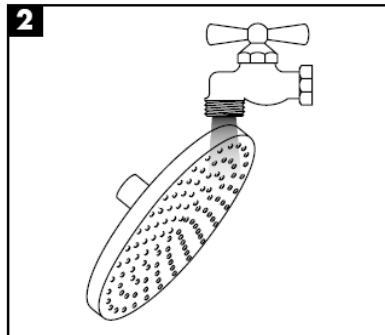
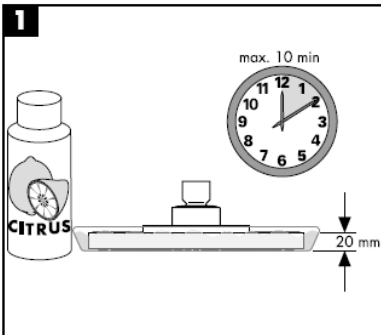

hansgrohe

Istruzioni per Installazione



27418XXX

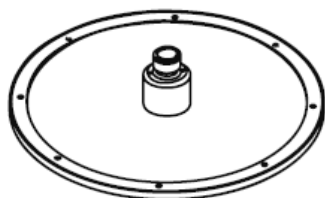

Raindance Royale AIR
28420000

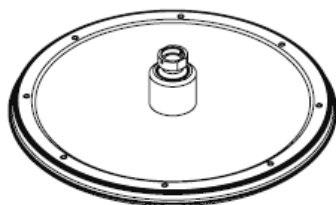

Raindance Royale Classic AIR
28435XXX

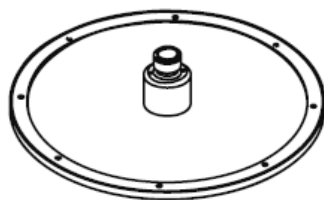

**Raindance Royale
High Flow Set**
27070000

hangrohe

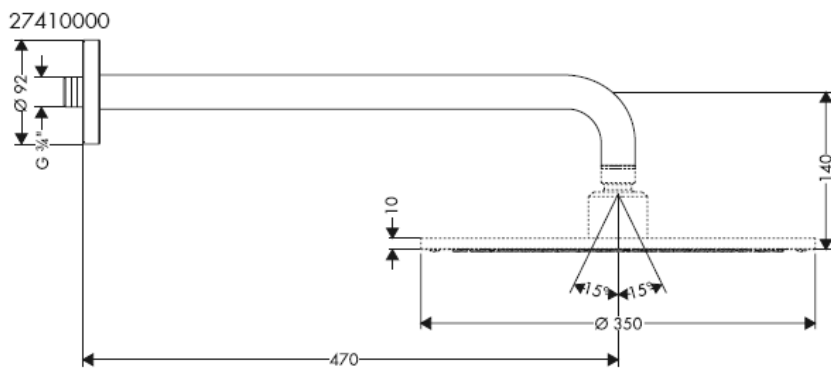
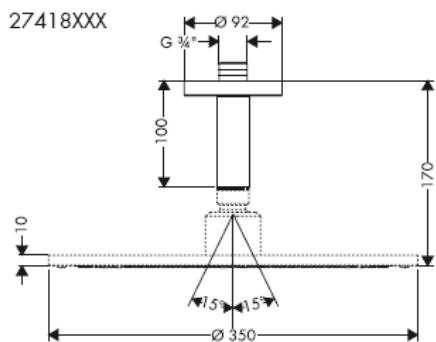
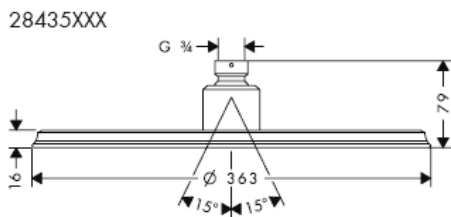
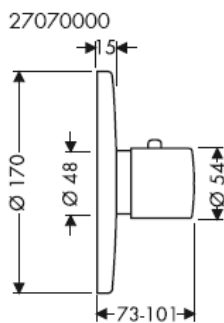
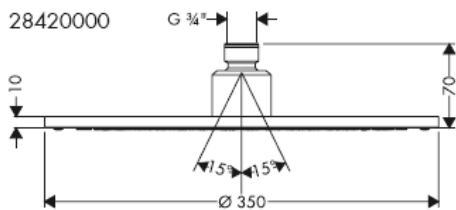

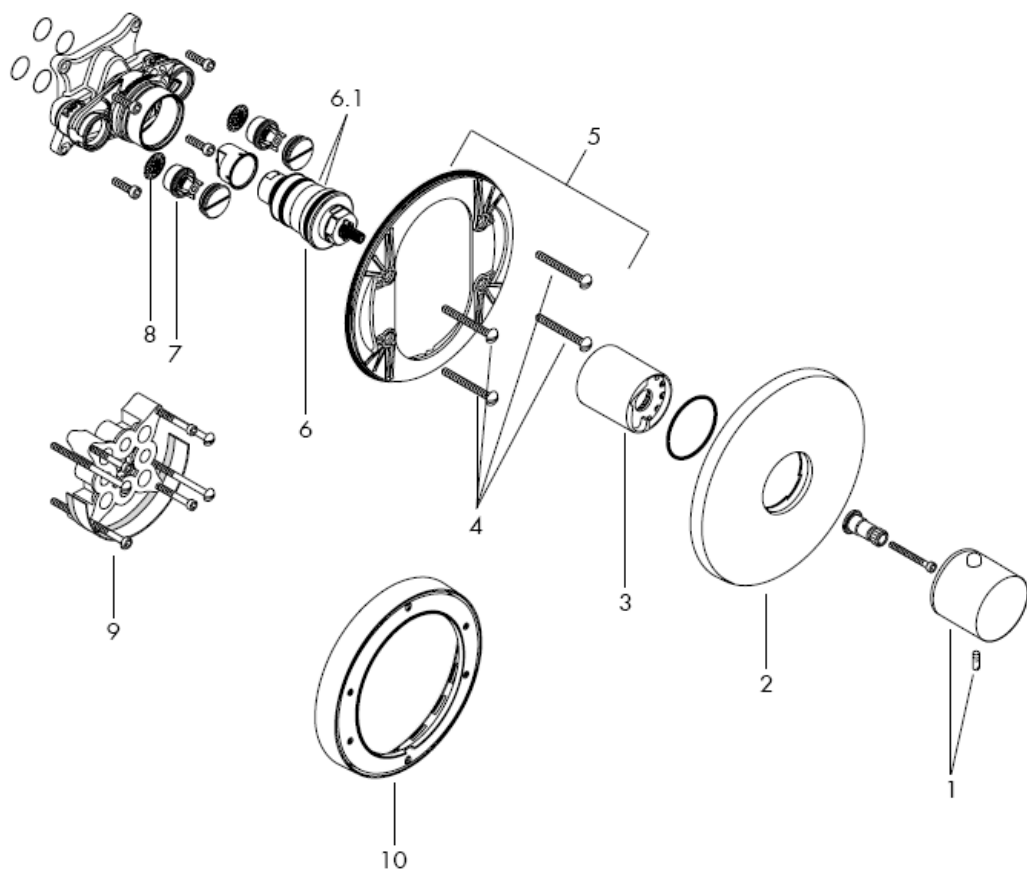

Adattare le misure alla dimensione delle piastrelle.

Campo rinforzo necessario della parete

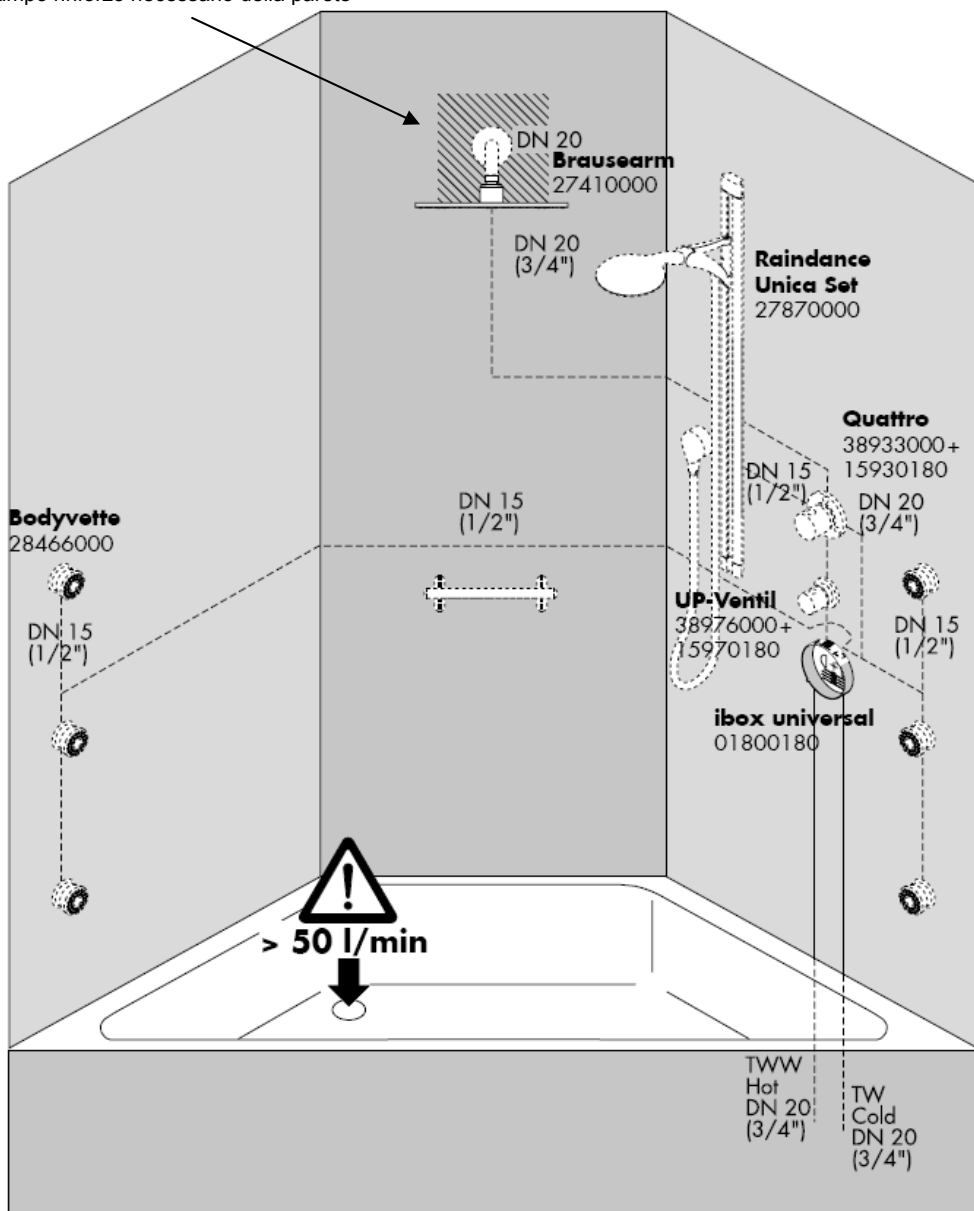

Dal • si garantisce la funzionalità.

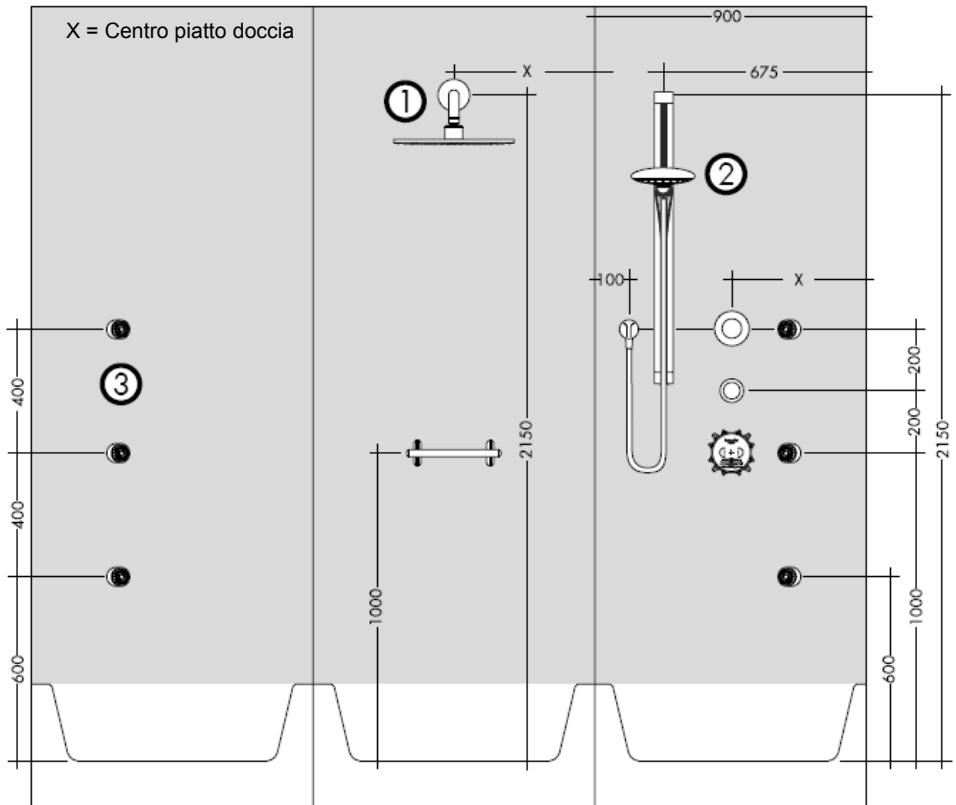
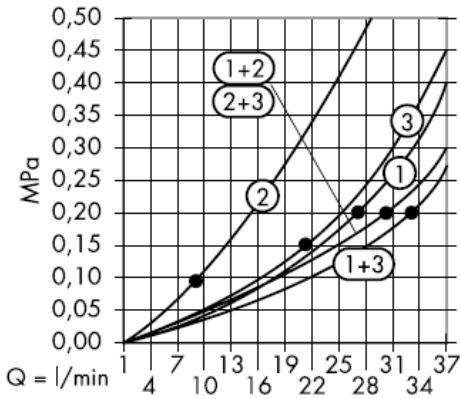

Campo rinforzo necessario della parete

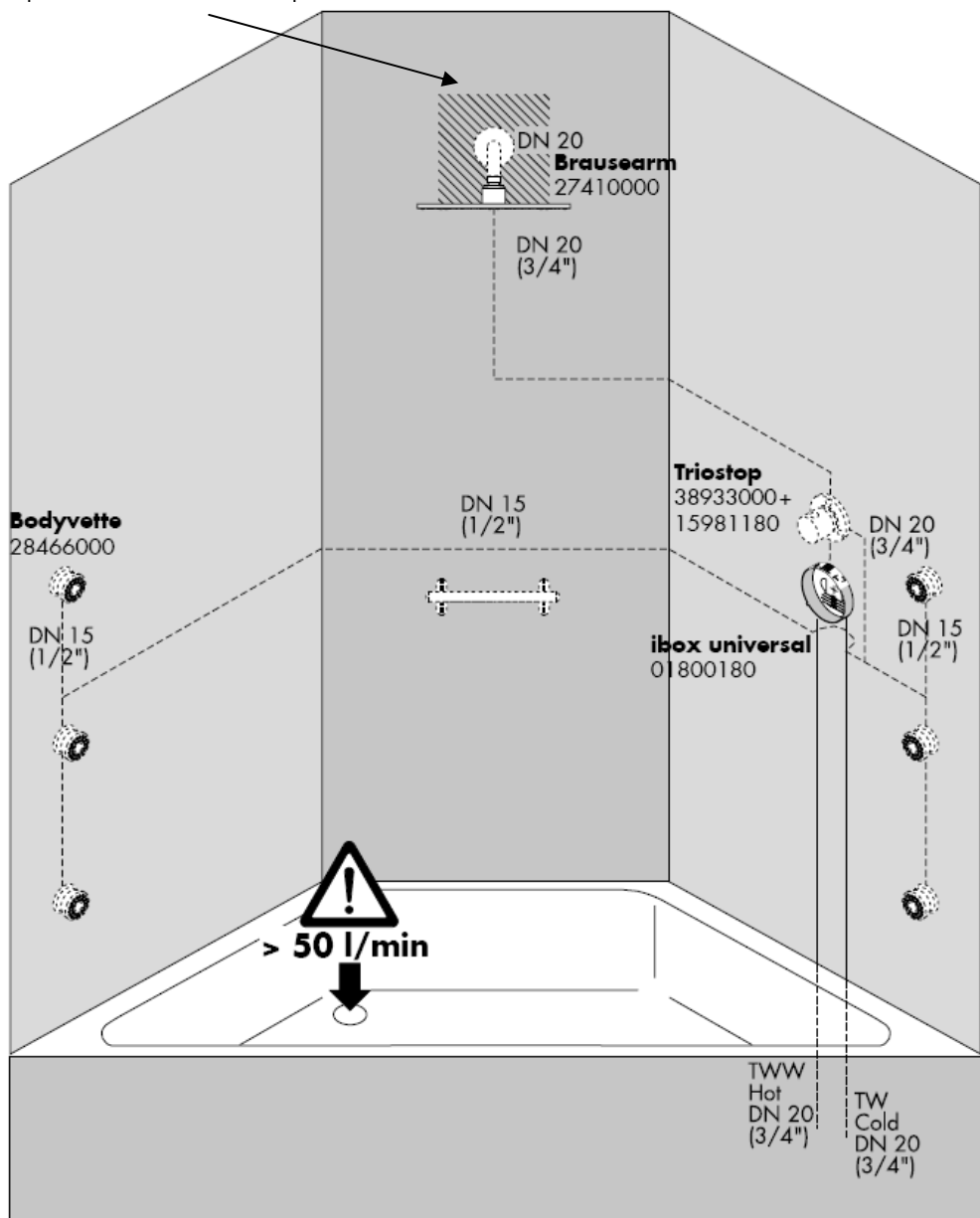

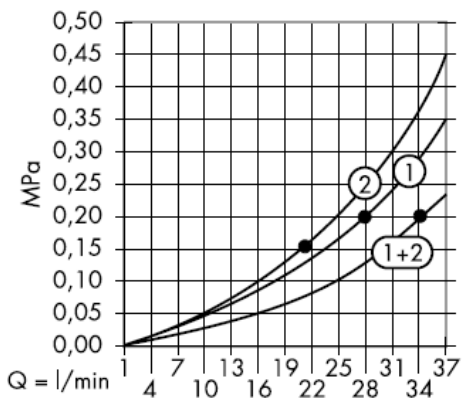

Dal • si garantisce la funzionalità.

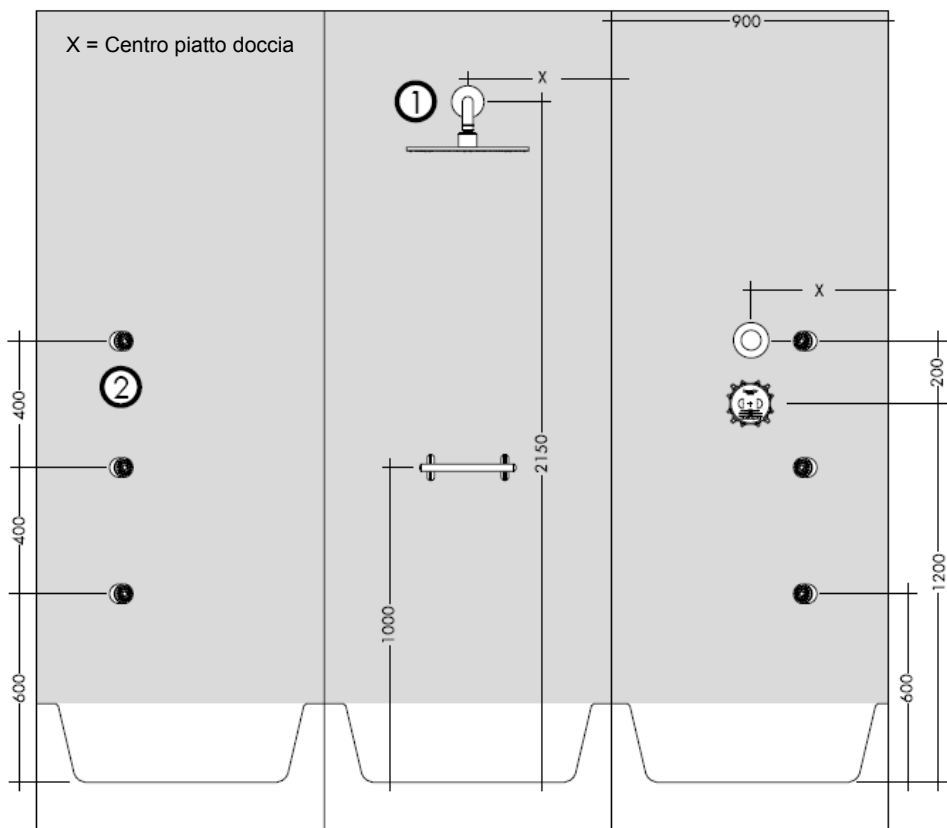

Campo rinforzo necessario della parete

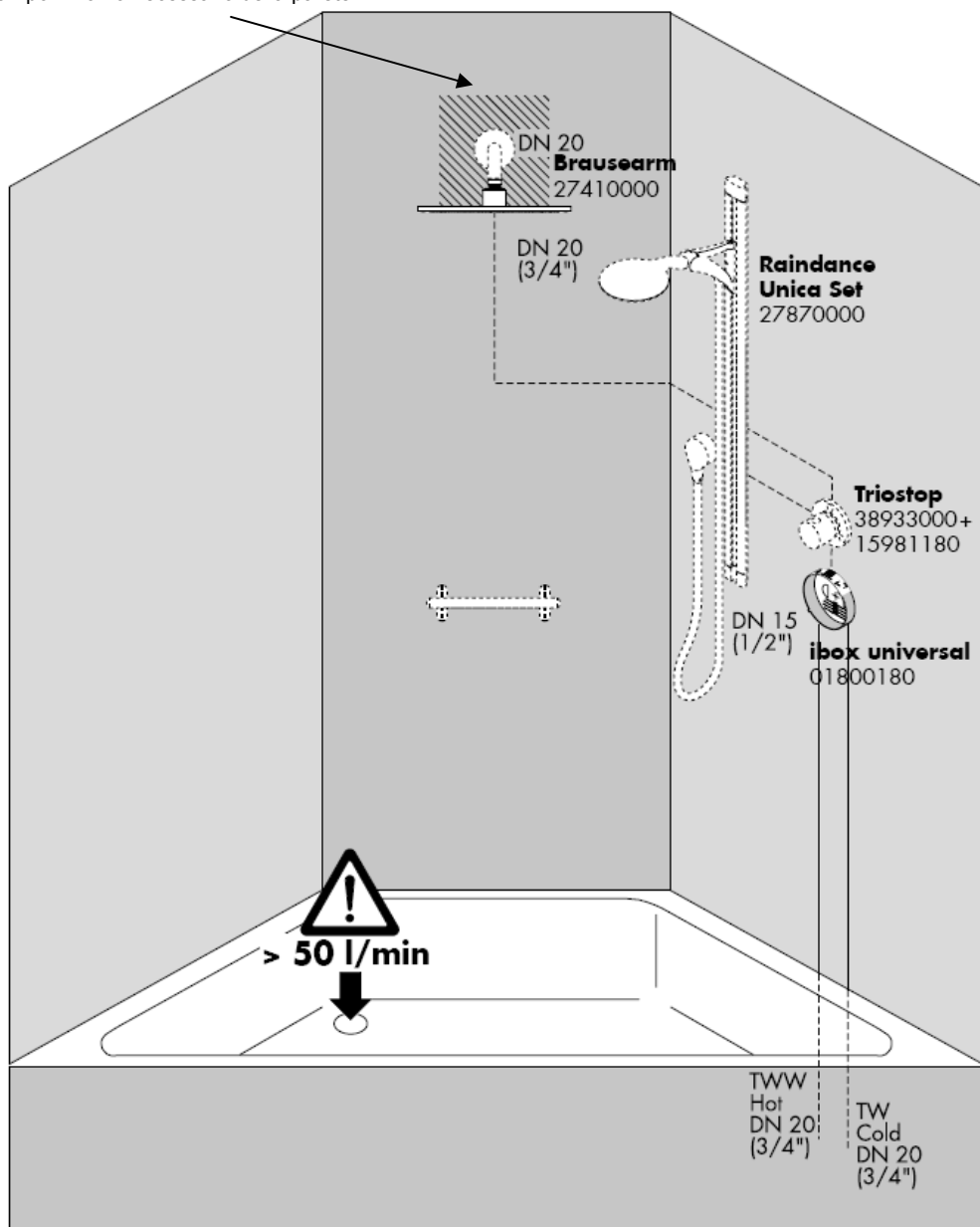

Dal • si garantisce la funzionalità.

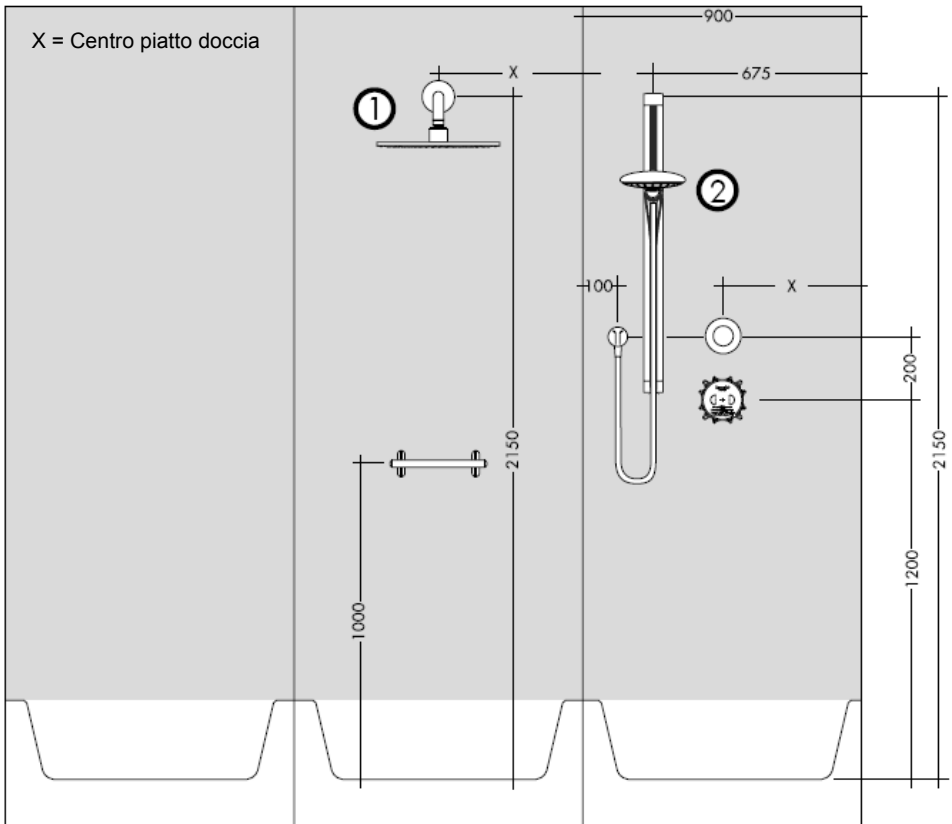
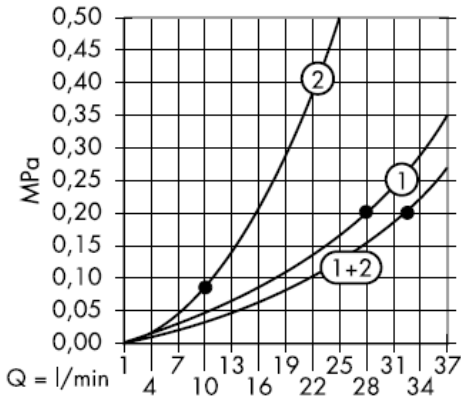

Campo rinforzo necessario della parete

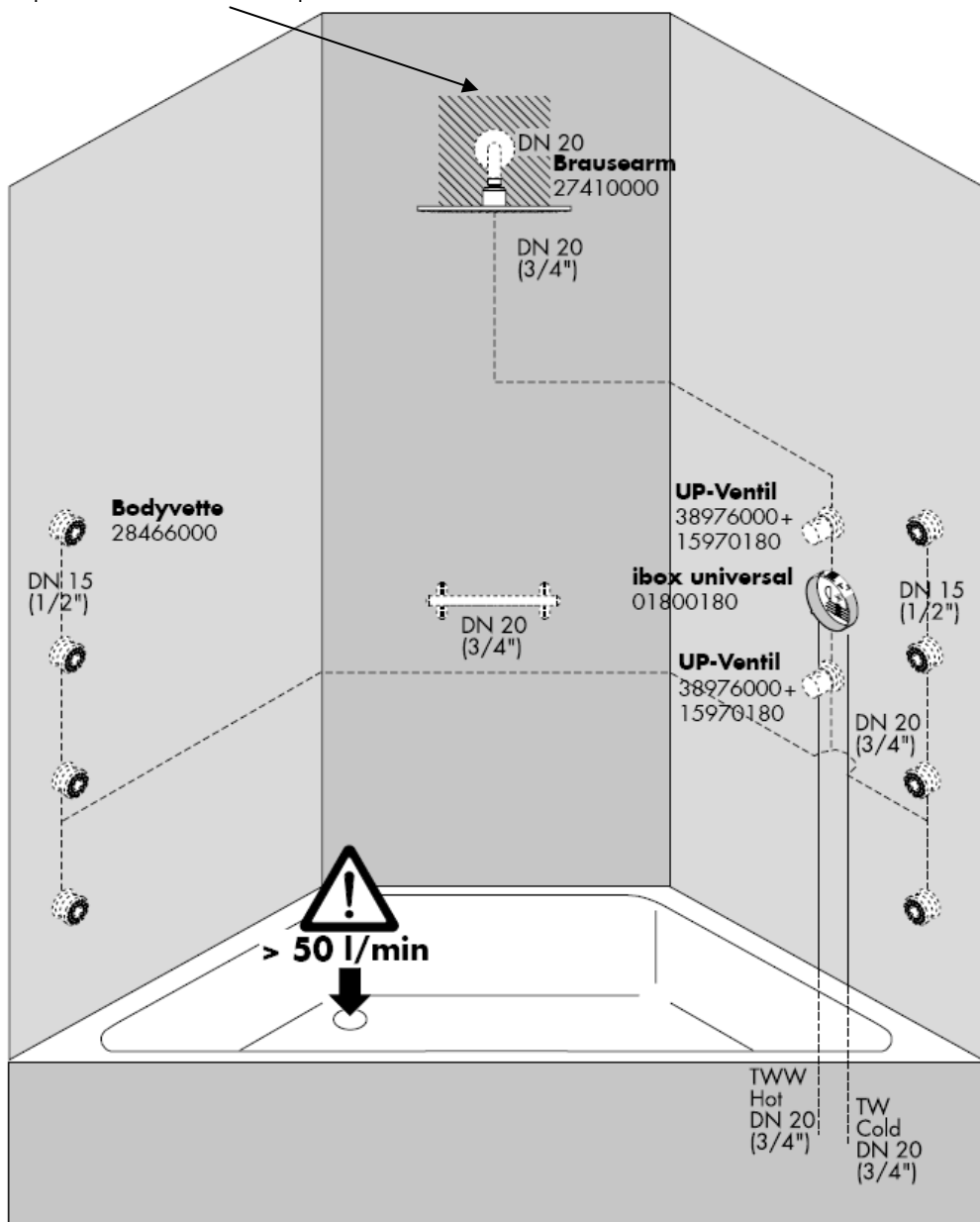

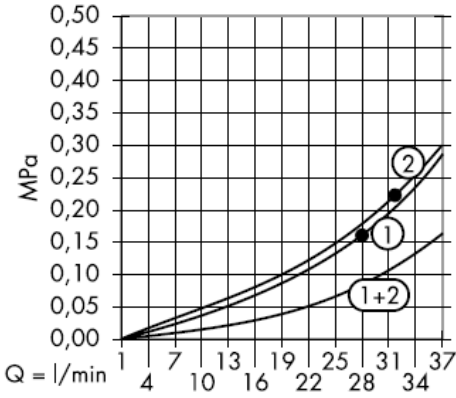

Dal • si garantisce la funzionalità.

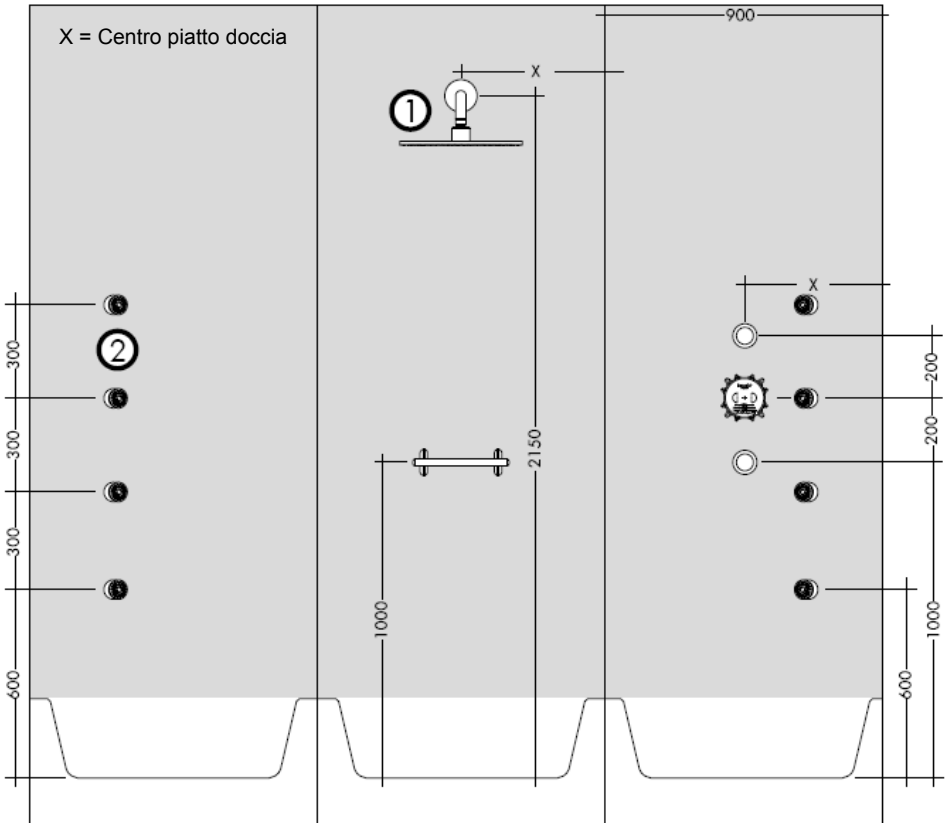

Campo rinforzo necessario della parete

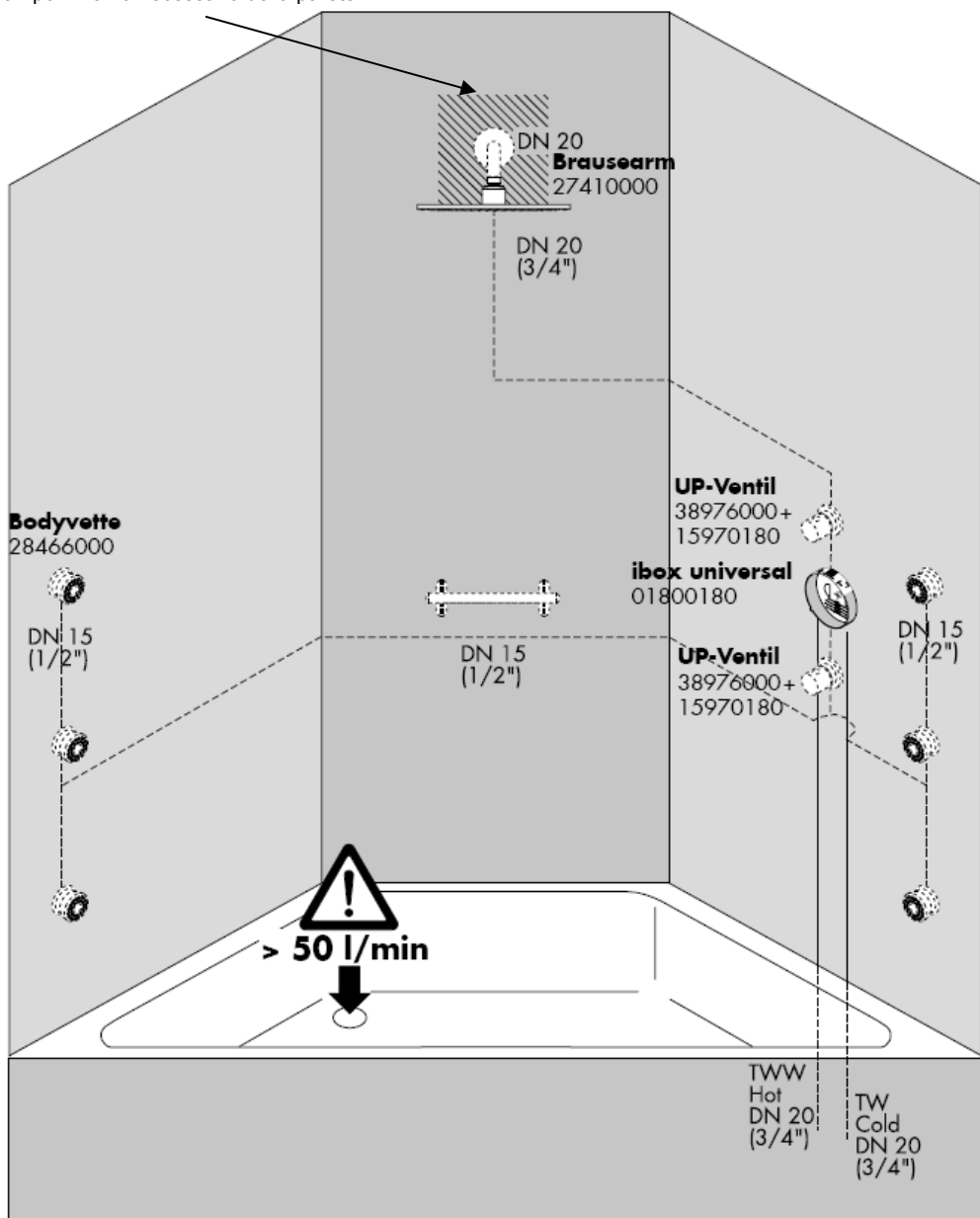

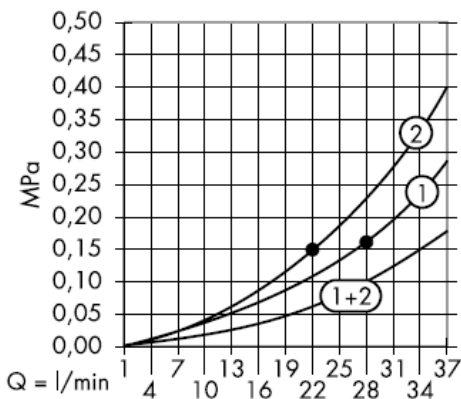

Dal • si garantisce la funzionalità.

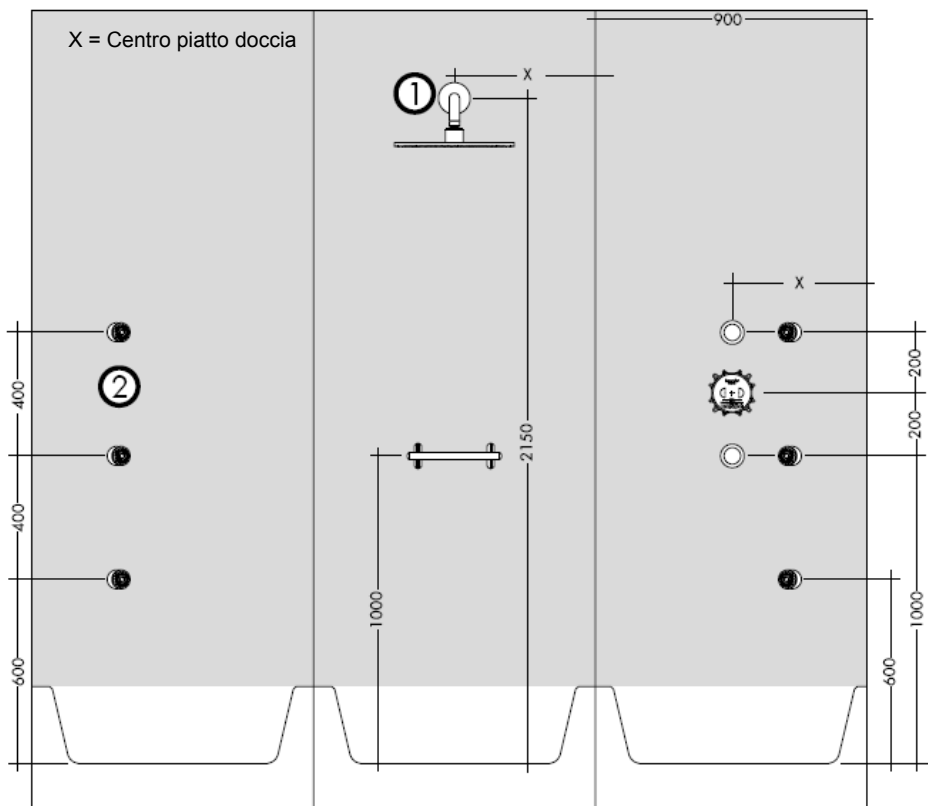

Campo rinforzo necessario della parete

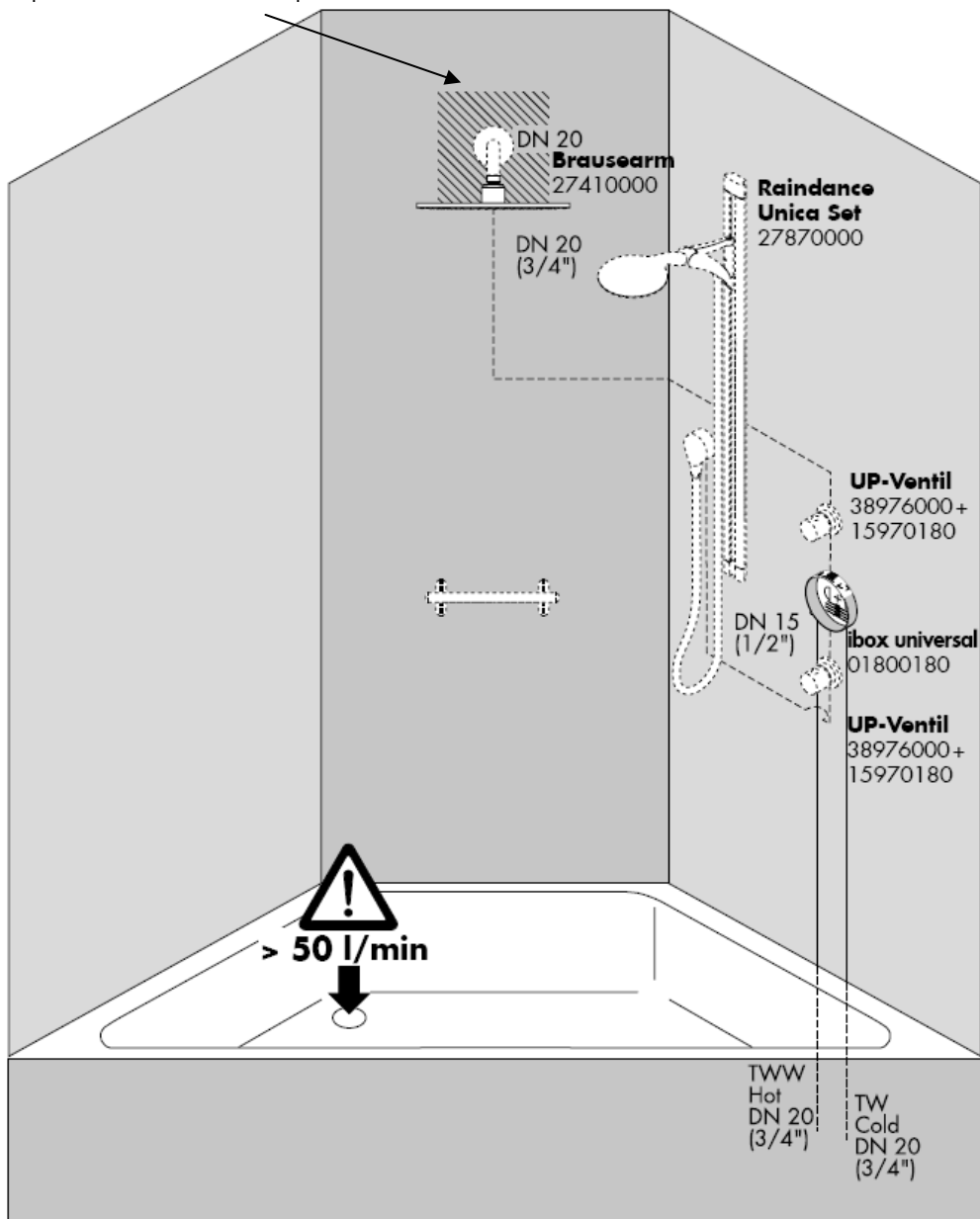

Dal • si garantisce la funzionalità.

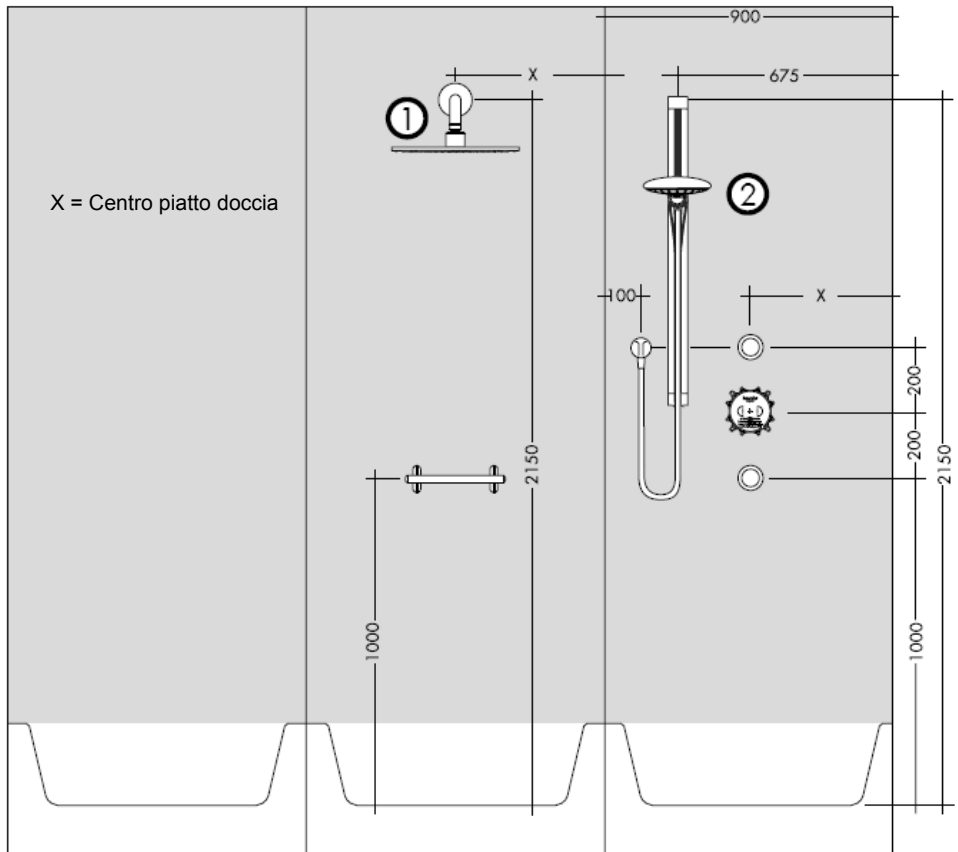
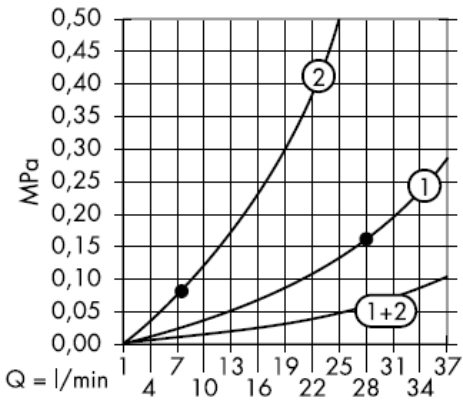

Campo rinforzo necessario della parete

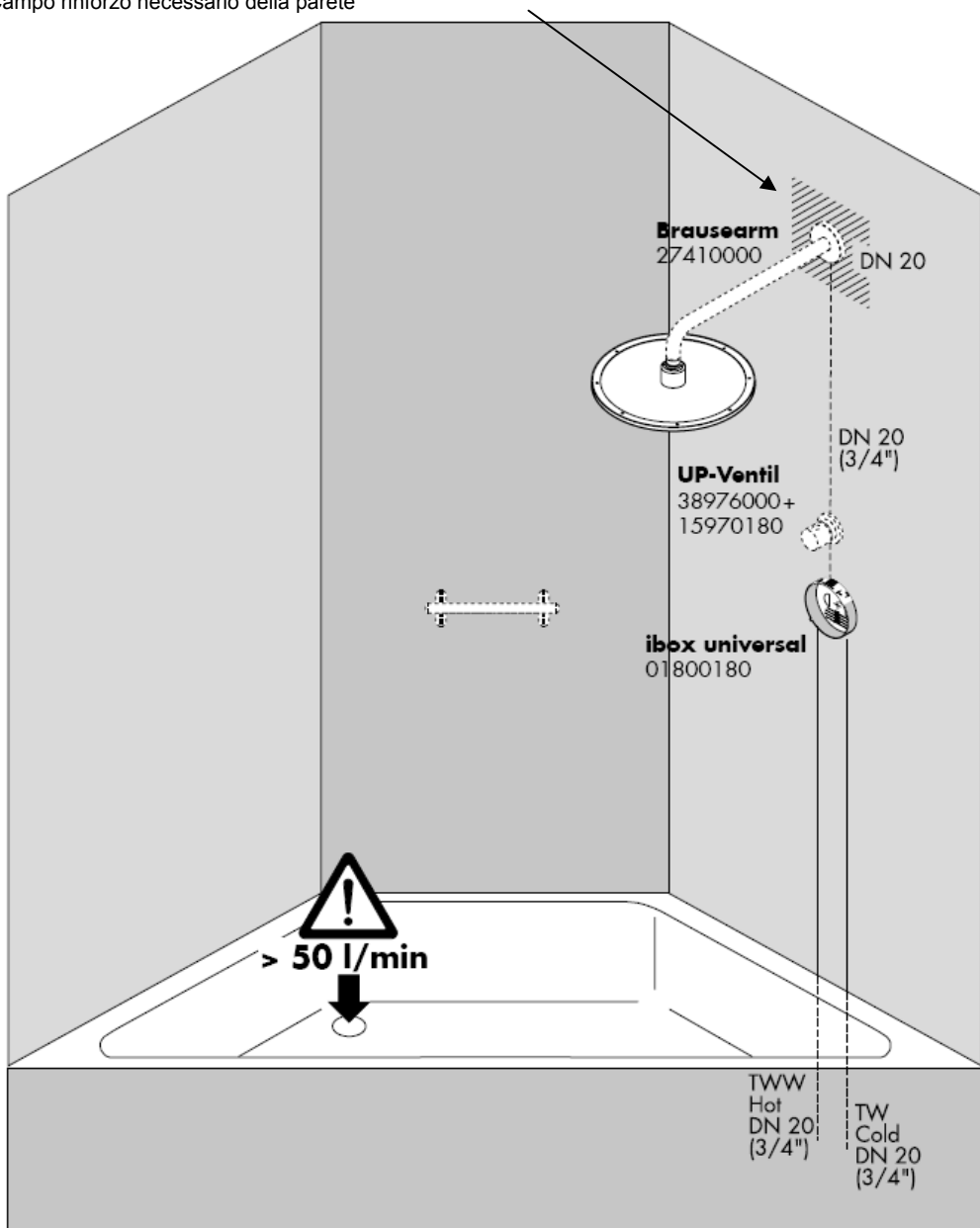

Dal • si garantisce la funzionalità.

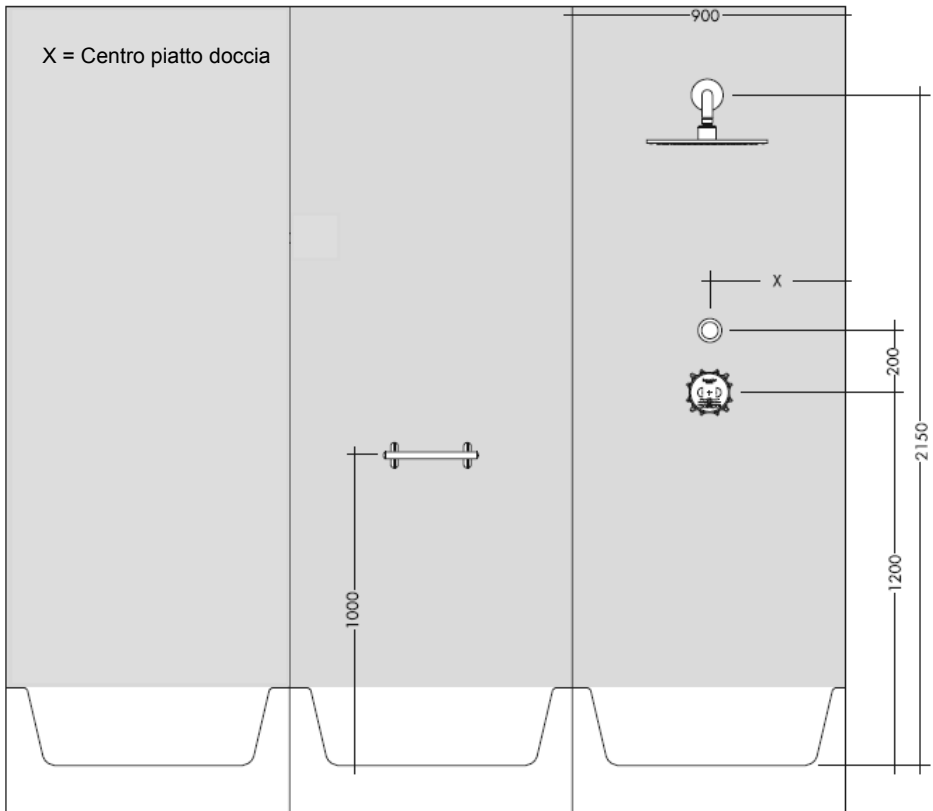
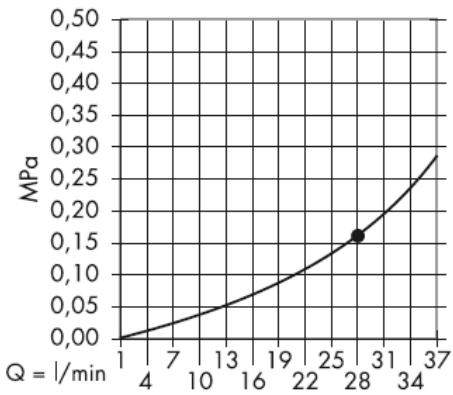

Campo rinforzo necessario della parete

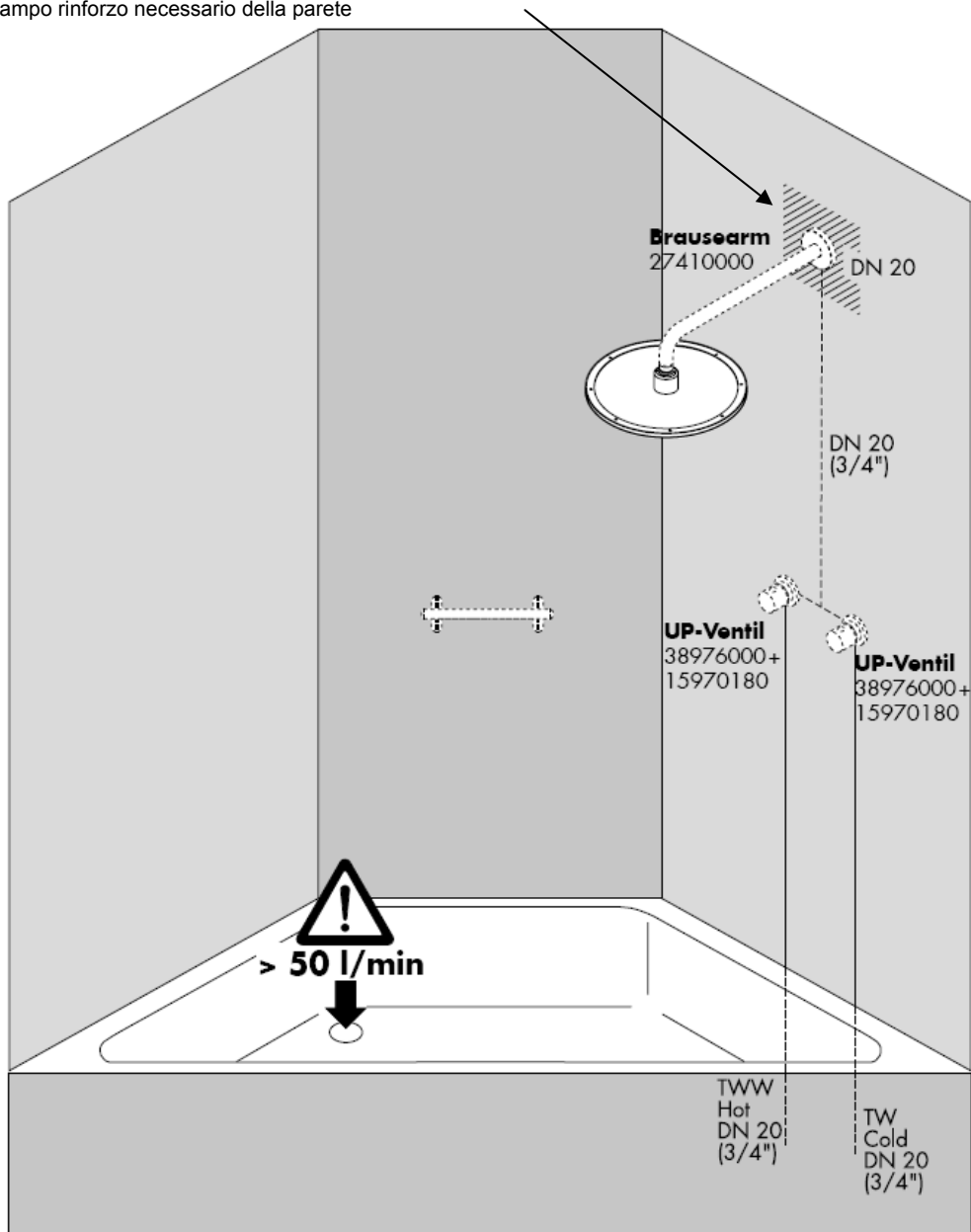

Dal • si garantisce la funzionalità.

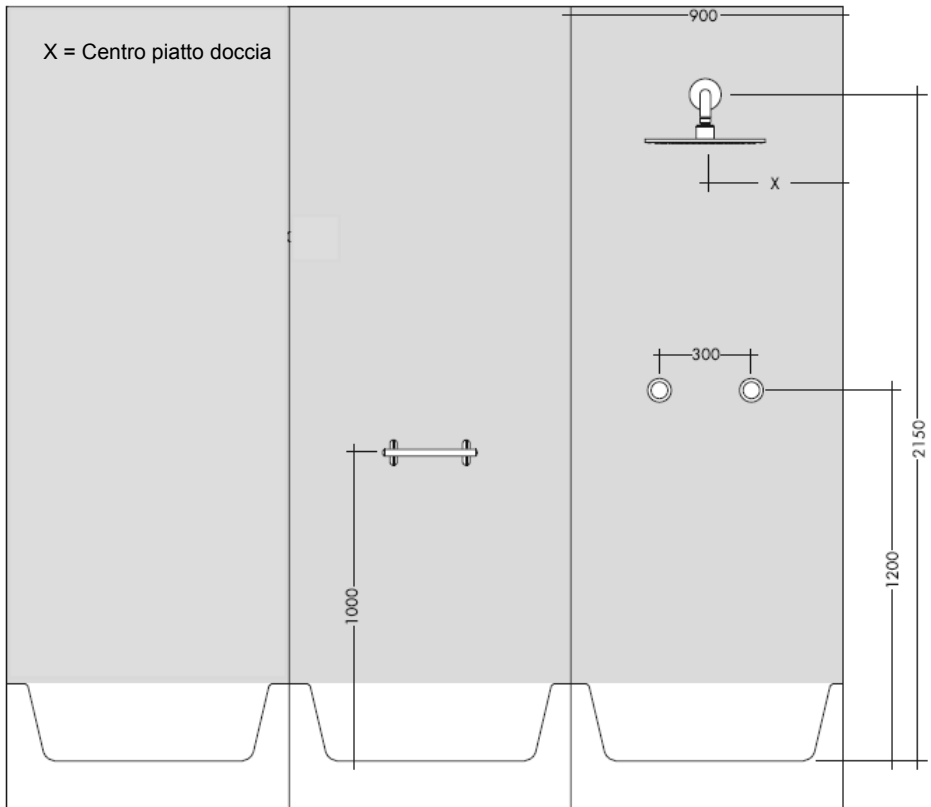
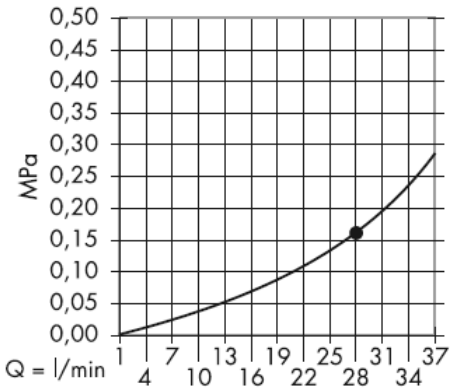

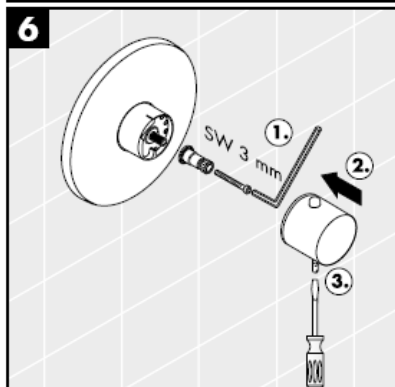
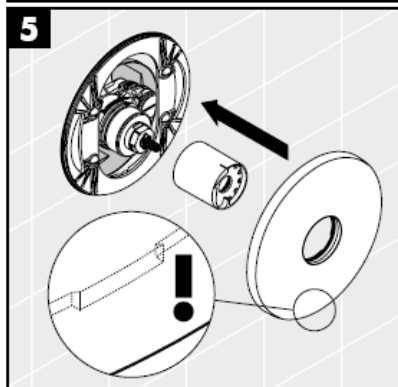
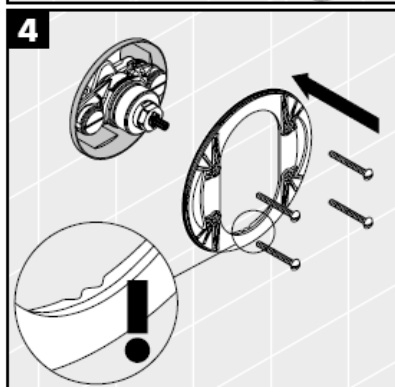
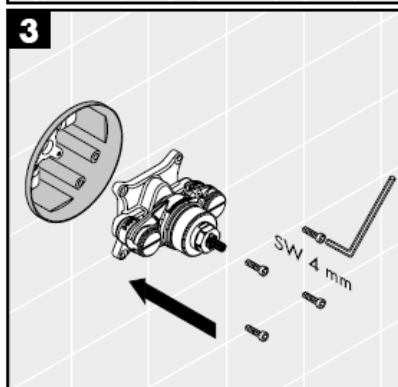
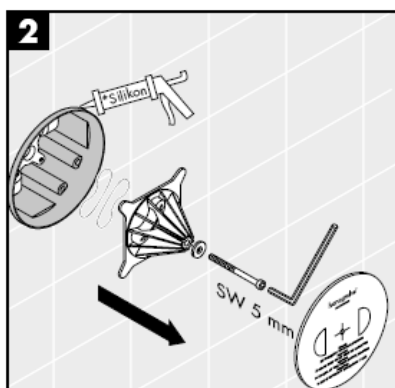
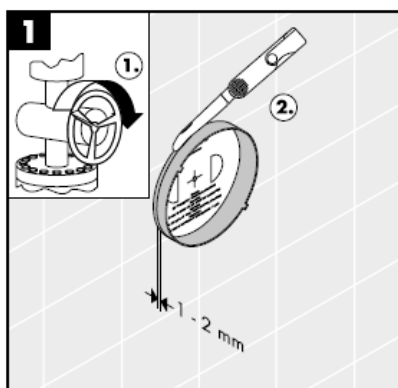

Silicone (essente da acido acetico!)

Grazie alla funzione antiscottature Safety la temperatura massima per esempio max. 42 C desiderata è facilmente regolabile.

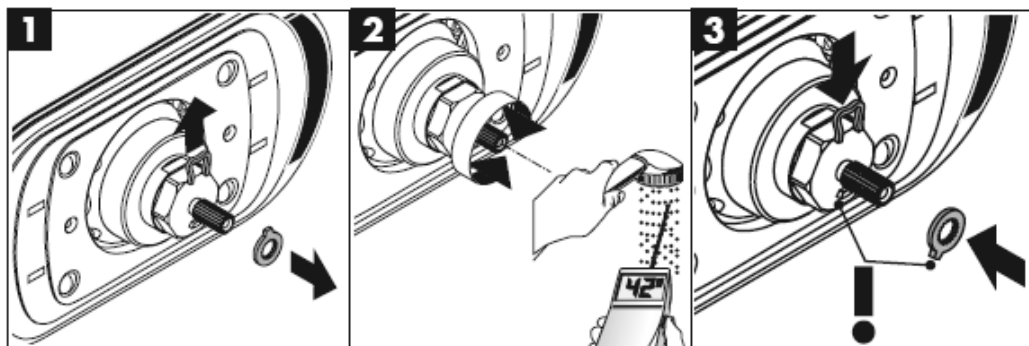

Taratura

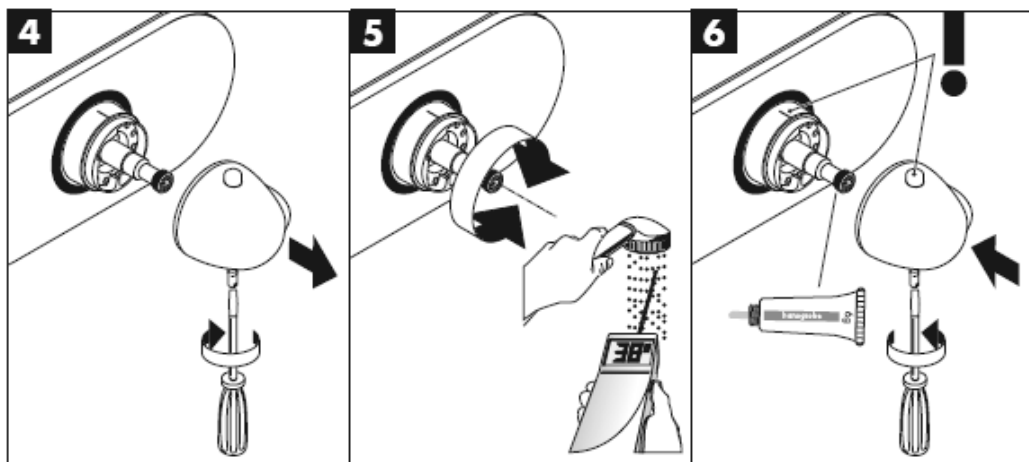



Una volta in funzione il soffione doccia insieme al braccio doccia possono raggiungere un peso di circa 10 kg. Per questo motivo è permesso utilizzare soltanto materiale di fissaggio adatto alla rispettiva muratura! Le viti ed i tasselli allegati sono pre

È permesso utilizzare esclusivamente materiale di fissaggio adatto alla rispettiva muratura! Le viti ed i tasselli allegati sono previsti solo per muratura compatta.

Lo scarico deve essere sufficientemente dimensionato.

Funzionalità ottimale solamente in combinazione con High Flow termostatici Hansgrohe.

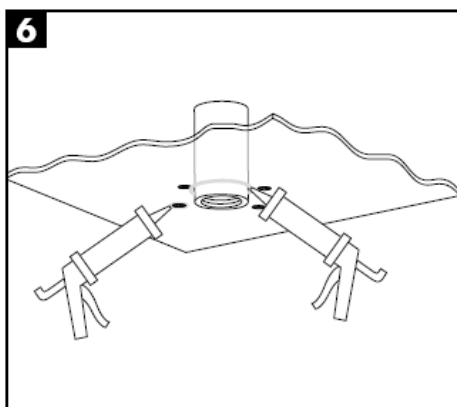
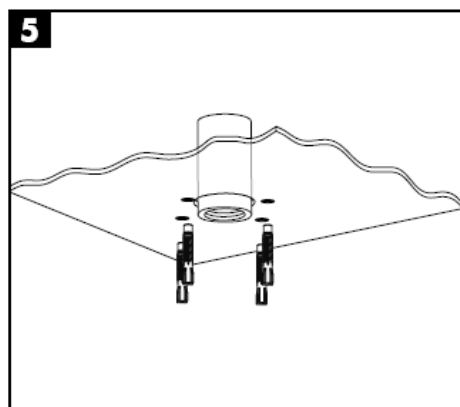
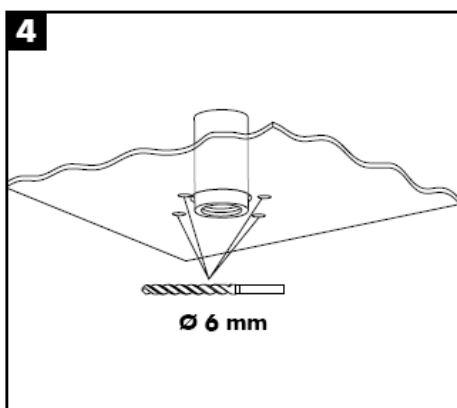
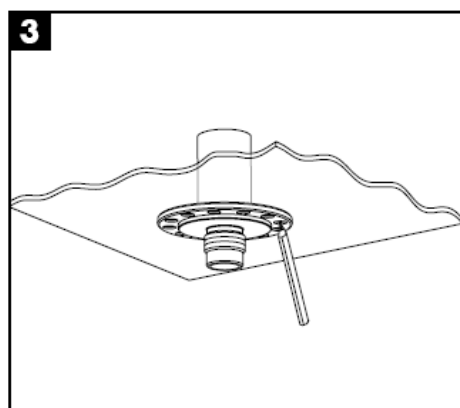
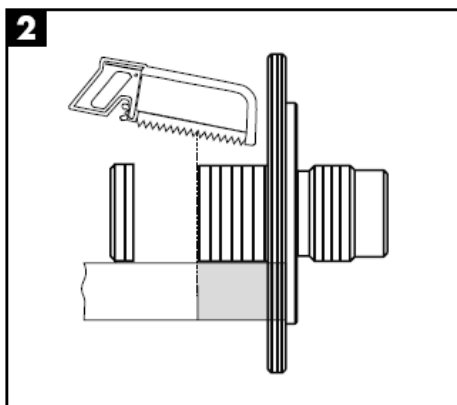
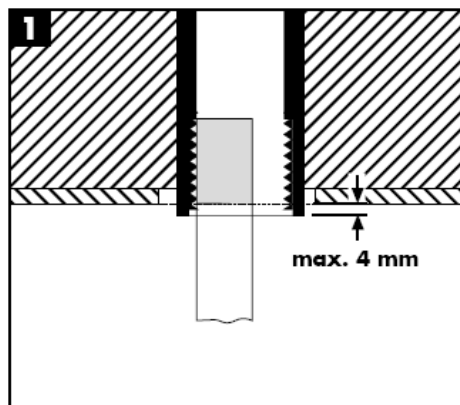

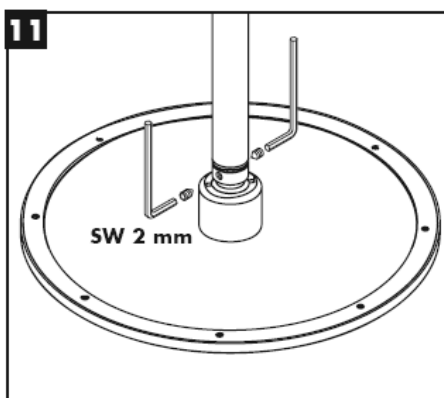
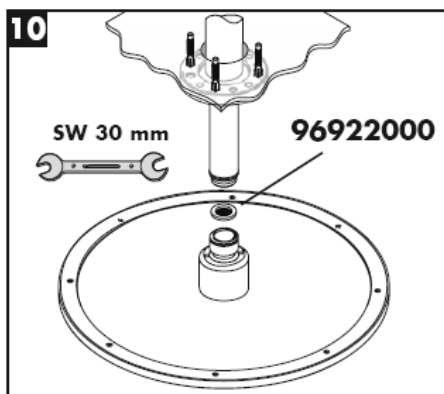
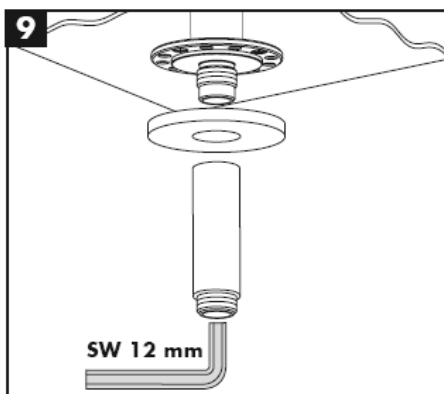
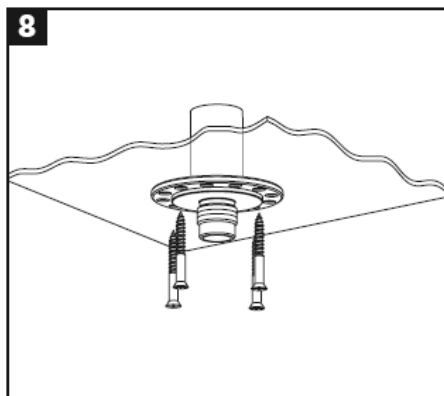
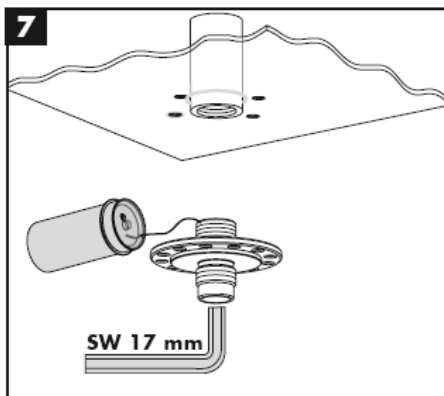

Per proteggere la soffione doccia da eventuali impurità provenienti dalle tubazioni dell'acqua, deve essere inserito il filtro nell'impugnatura della doccia stessa. Tali impurità possono infatti causare difetti e/o danneggiare parti della doccia; in questo caso la Hansgrohe non risponde dei danni.

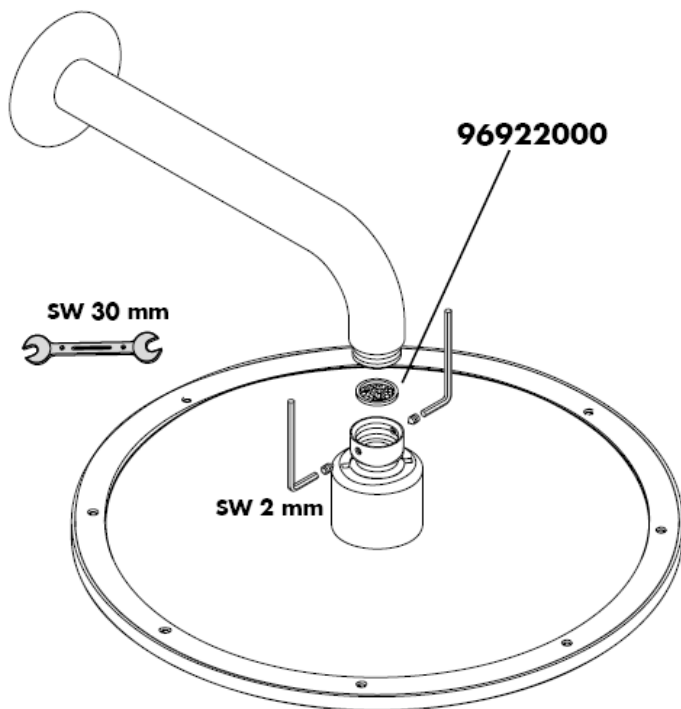

Montaggio

Attenzione! La rubinetteria deve essere installata, pulita e testata secondo le istruzioni riportate!

Taratura

Una taratura è necessaria quando la temperatura dell'acqua misurata sul punto di prelievo non corrisponde a quella registrata sul termostatico. Operazioni di taratura: Girare la manopola graduata sino al punto di arresto. Uscita d'acqua a 38 °C. Allentare la vite della manopola. Ritrarre la manopola e girarla sino alla posizione 38 °C. Inserire la manopola ed avvitare la vite della manopola (vedere pagina 22).

Limitazione della temperatura

La gamma di temperatura è limitata a 38 °C con un blocco di sicurezza. Se si desidera una temperatura più alta di 38 °C, il blocco di sicurezza può essere superato premendo sul pulsante.

Safety Function

Grazie alla funzione antiscottature Safety la temperatura massima per esempio max. 42 °C desiderata è facilmente regolabile. vedi pagg. 21.

Dati tecnici

Pressione d'uso: max. 1 MPa
 Pressione d'uso consigliata: 0,1 – 0,5 MPa
 Pressione di prova: 1,6 MPa
 (1 MPa = 10 bar = 147 PSI)
 Temperatura dell'acqua calda: max. 80° C
 Temp. dell'acqua calda consigliata: 65° C
 Portata di erogazione: ca. 5.8 l/min 0,3 MPa

Manutenzione

I termostatici non necessitano di una particolare manutenzione. La valvola di non ritorno deve essere controllata regolarmente come da DIN EN 1717, secondo le normative nazionali e regionali (almeno una volta all'anno). In tale occasione controllate anche i filtri che si trovano sulla cartuccia termostatica MTC (6.1). Dopo aver montato la cartuccia termostatica MTC (6), è necessario controllare la temperatura di erogazione come descritto nel paragrafo "Taratura". Prima controllate assolutamente se l'alimentazione di acqua calda funziona e che la temperatura massima non superi i valori consigliati.

Per garantire la scorrevolezza dell'elemento di regolazione, di tanto in tanto si dovrebbe regolare il termostatico passando da tutto caldo a tutto freddo.

Parti di ricambio vedi pagg. 3

1	manopola termostatico	38391000
2	copertura	96452000
3	canotto	97439000
4	vite portante	96454000
5	copertura portante	96447000
6	elemento termostatico	96633000
7	filtro	97367000
8	valvola antiriflusso	96655000
9	Prolunga 25 mm	13595000
10	Prolunga 25 mm	13596000

Italiano

Problema	Possibile causa	Rimedio
Scarsità d'acqua	-Pressione di erogazione insufficiente -Filtro dell'unità di regolazione sporco -Guarnizione del filtro della doccia sporca	-Provare la pressione di erogazione -Pulire il filtro -Pulire la guarnizione del filtro tra doccia e flessibile
Flusso incrociato; l'acqua calda viene spinta nella tubatura acqua fredda a rubinetteria chiusa o viceversa	-Antiriflusso sporco o non ermetico	-Sostituire la valvola antiriflusso
La temperatura di erogazione diversa da quella impostata	-Il termostatico non è stato regolato -Temperatura dell'acqua calda	-Regolare il termostatico -Aumentare la temperatura acqua calda tra 42 C e 65 C
Impossibile la regolazione temperatura	-Elemento termostatico sporco o con depositi calcarei -Ruotare di 180 l'unità di regolazione	-In caso di nuova installazione - collegato male il termostatico (deve essere: acqua fredda a destra e calda a sinistra) o installato ruotato di 180 -Tasto antiscottatura non funzionante
Molla difettosa	-Pulire o sostituire la molla o il tasto -Tasto con depositi calcarei	-Pulire o sostituire la molla o il tasto -Pulire o sostituire la molla o il tasto

Segno di verifica

	P-IX	DVGW	SVGW	WRSA	KIWA	ACS	NF
27070000						X	
27418XXX							
28420000						X	
28435XXX						X	

Pulitura

Facile da pulire: Il calcare viene eliminato semplicemente dagli ugelli elastici in silicone.

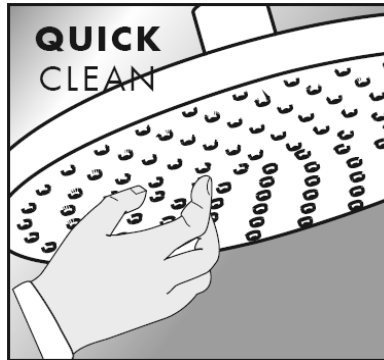

Istruzioni per il trattamento

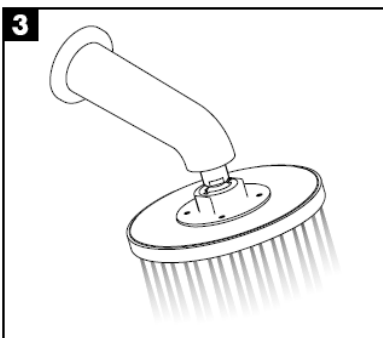
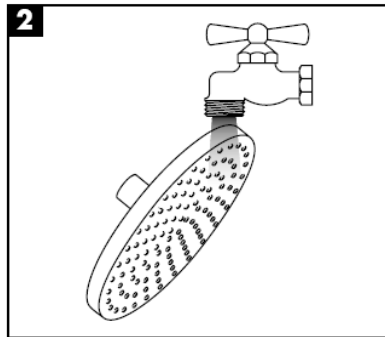
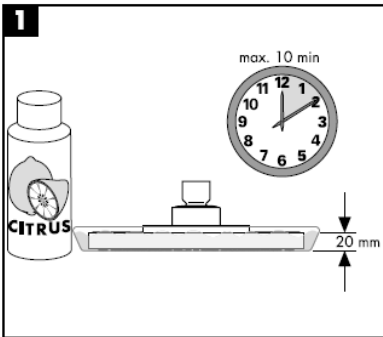

hansgrohe

Instrucciones de montaje



27418XXX

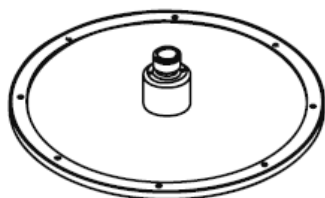

Raindance Royale AIR
28420000

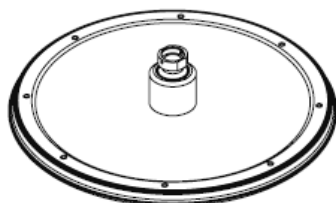

Raindance Royale Classic AIR
28435XXX

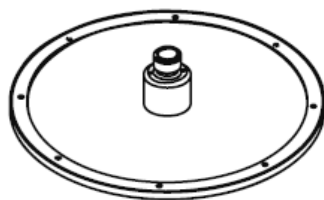

**Raindance Royale
High Flow Set**
27070000

hangrohe

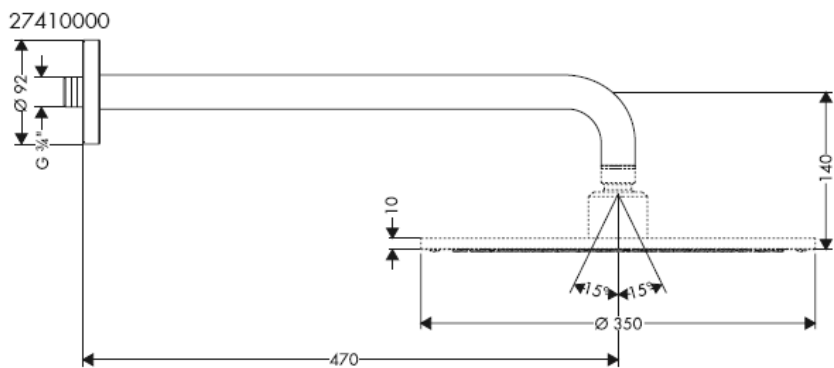
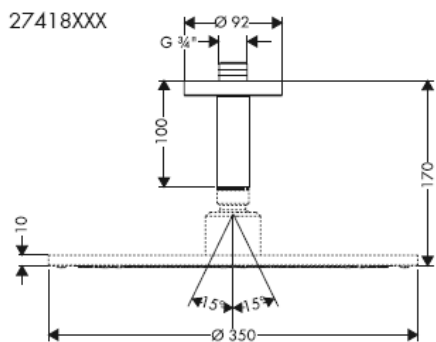
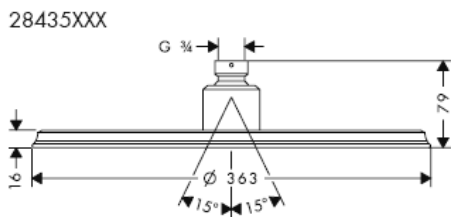
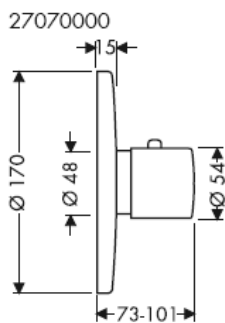
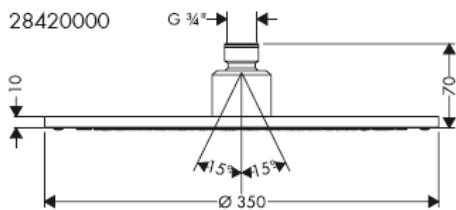

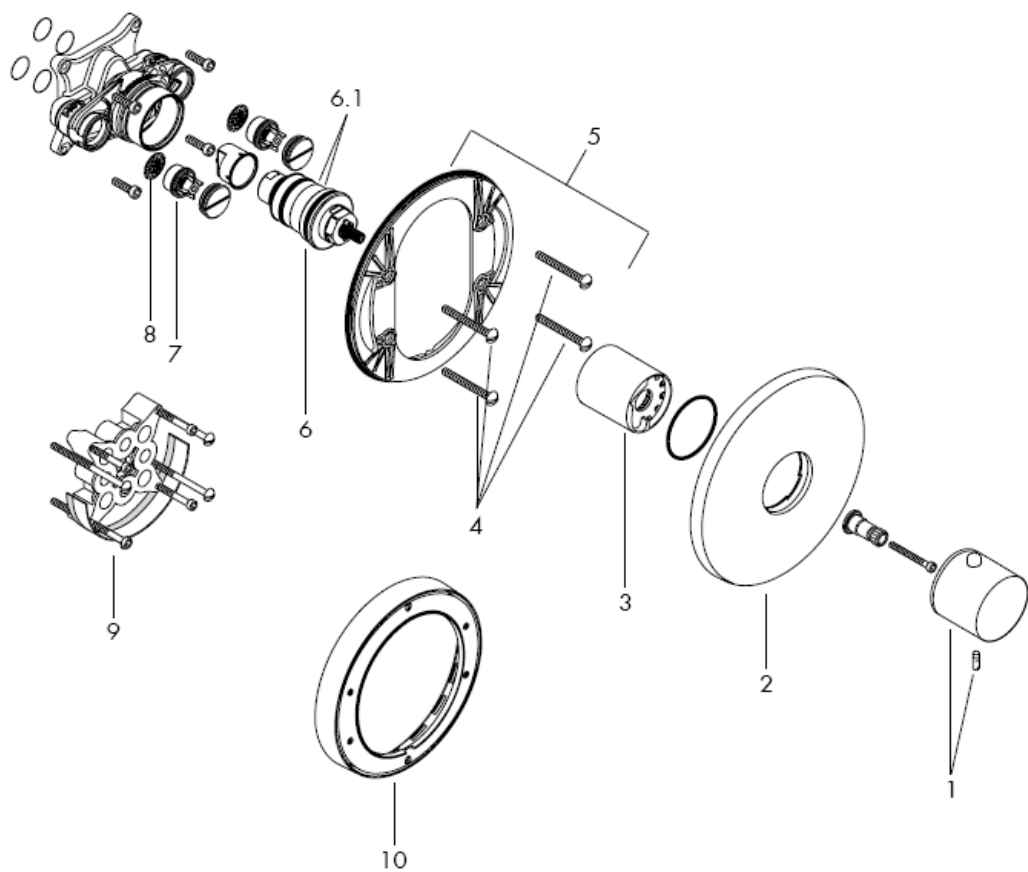

Adaptar las medidas al retículo de los azulejos.

Área refuerzo necesario de la pared

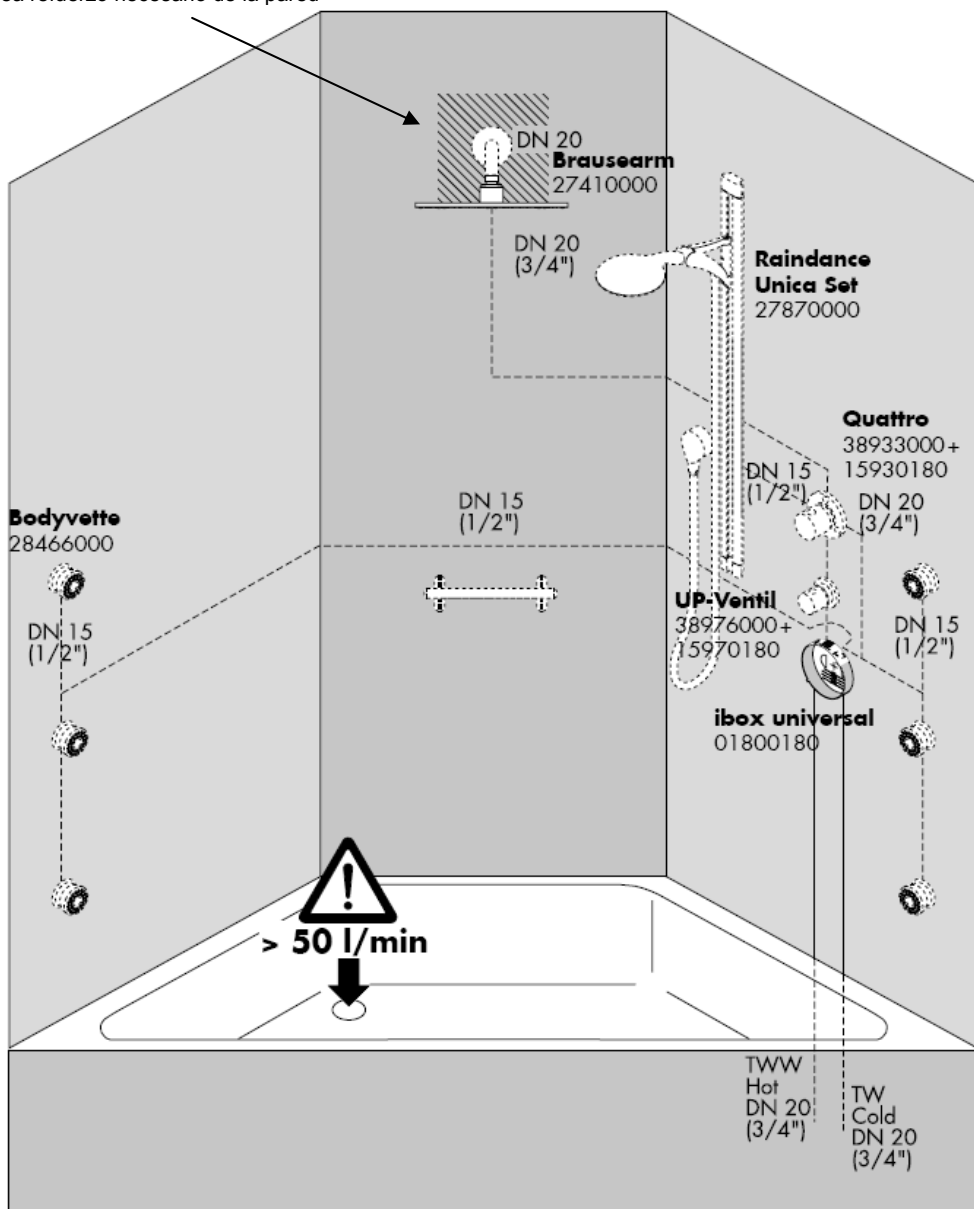

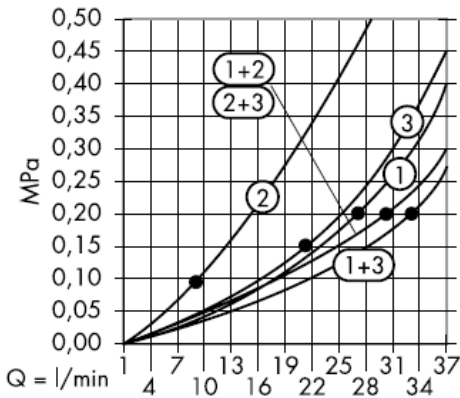

Mínimo • para el correcto funcionamiento.

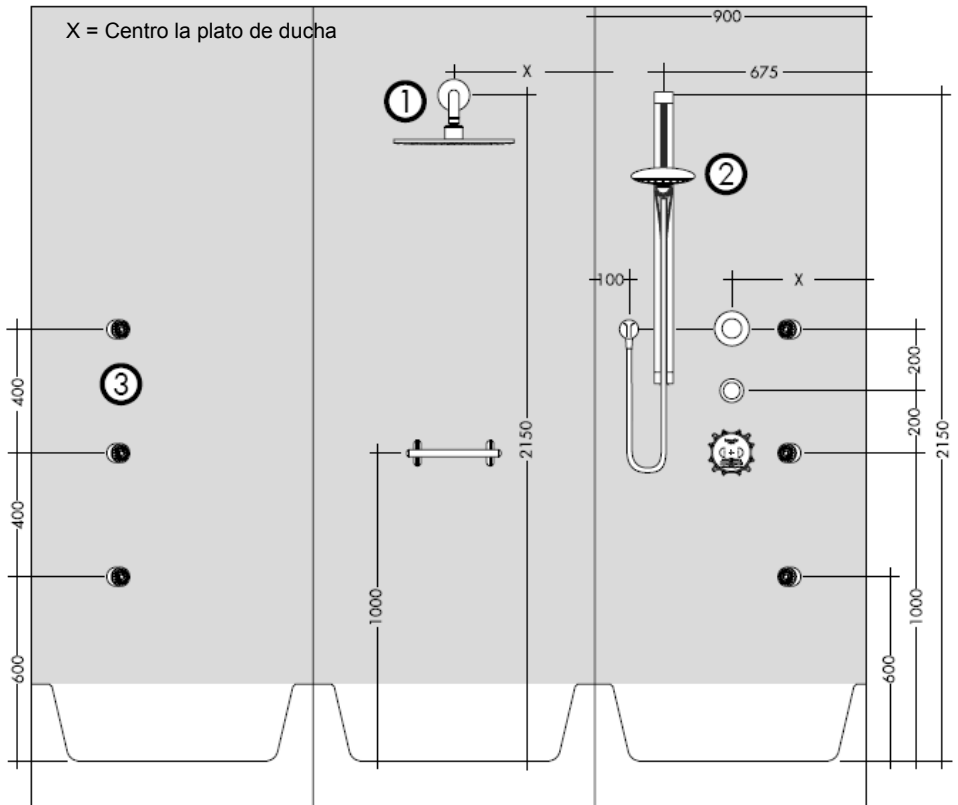

Área refuerzo necesario de la pared

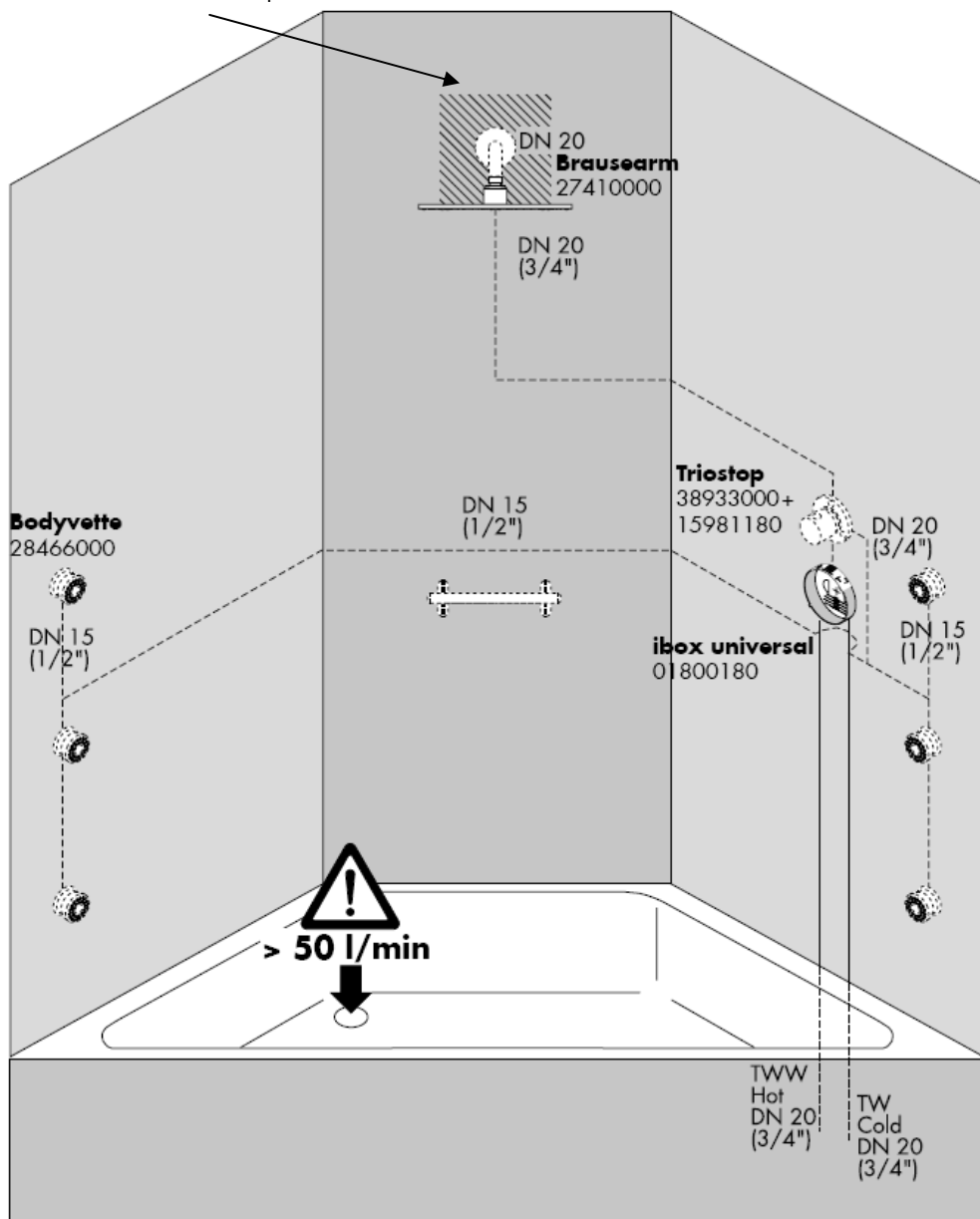

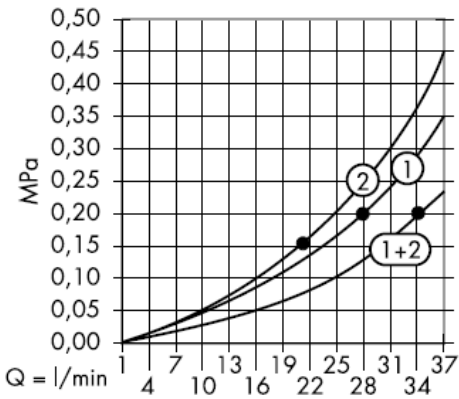

Mínimo • para el correcto funcionamiento.

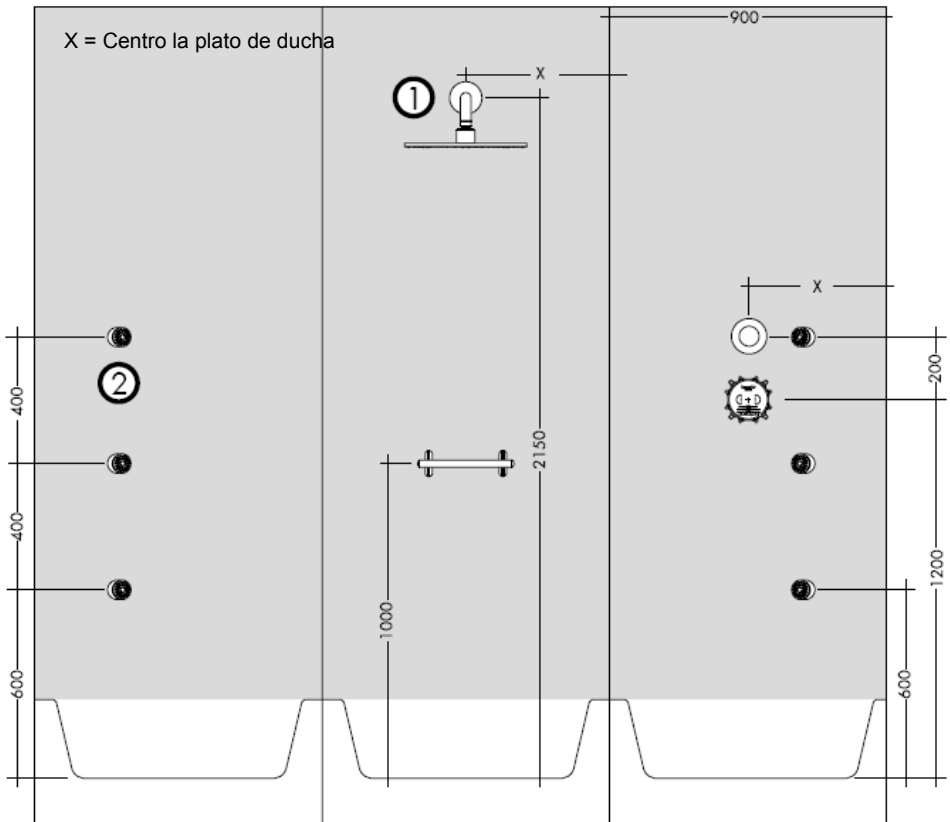

Área refuerzo necesario de la pared

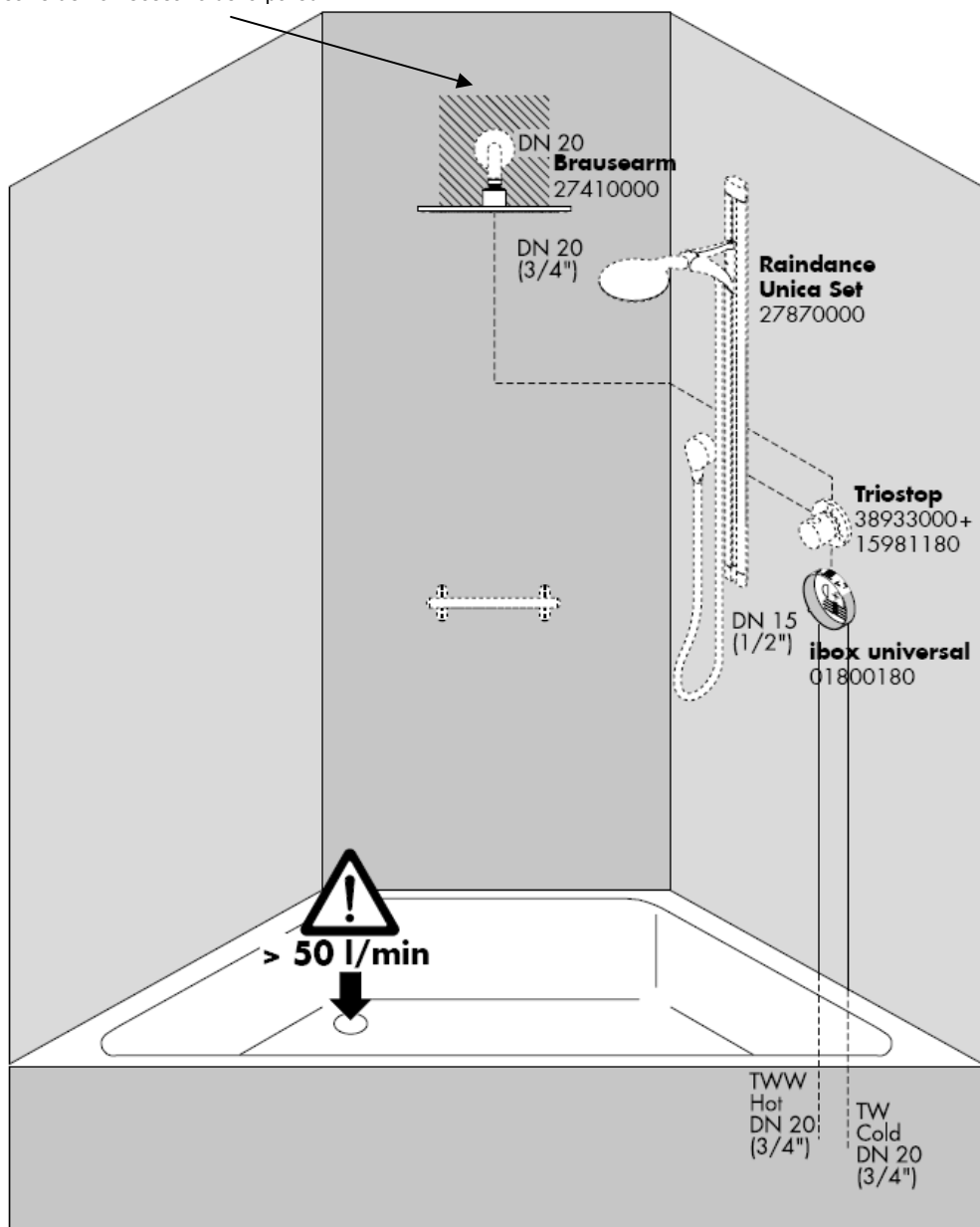

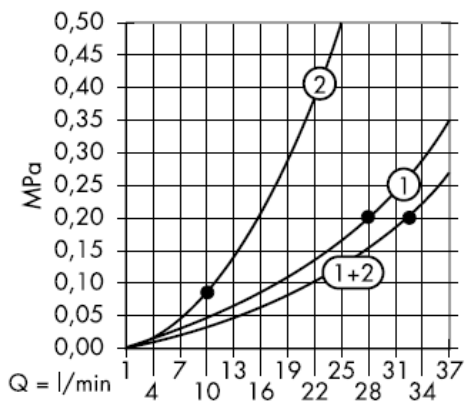

Mínimo • para el correcto funcionamiento.

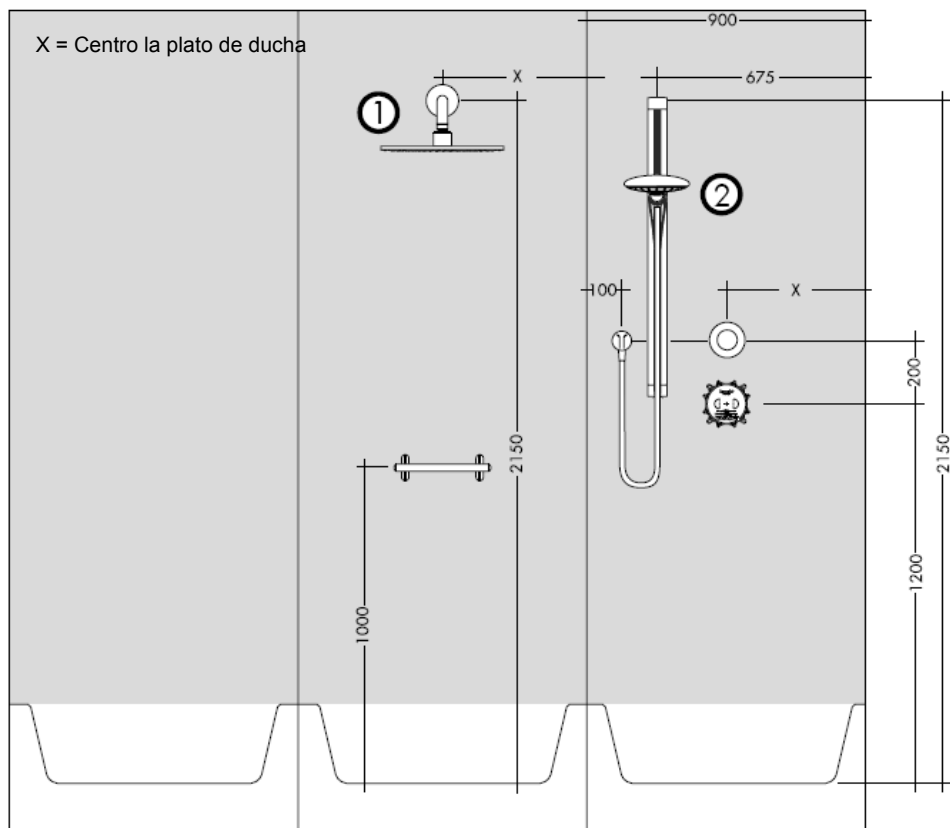

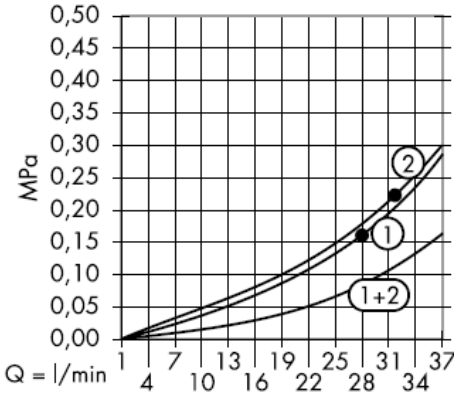

Mínimo • para el correcto funcionamiento.

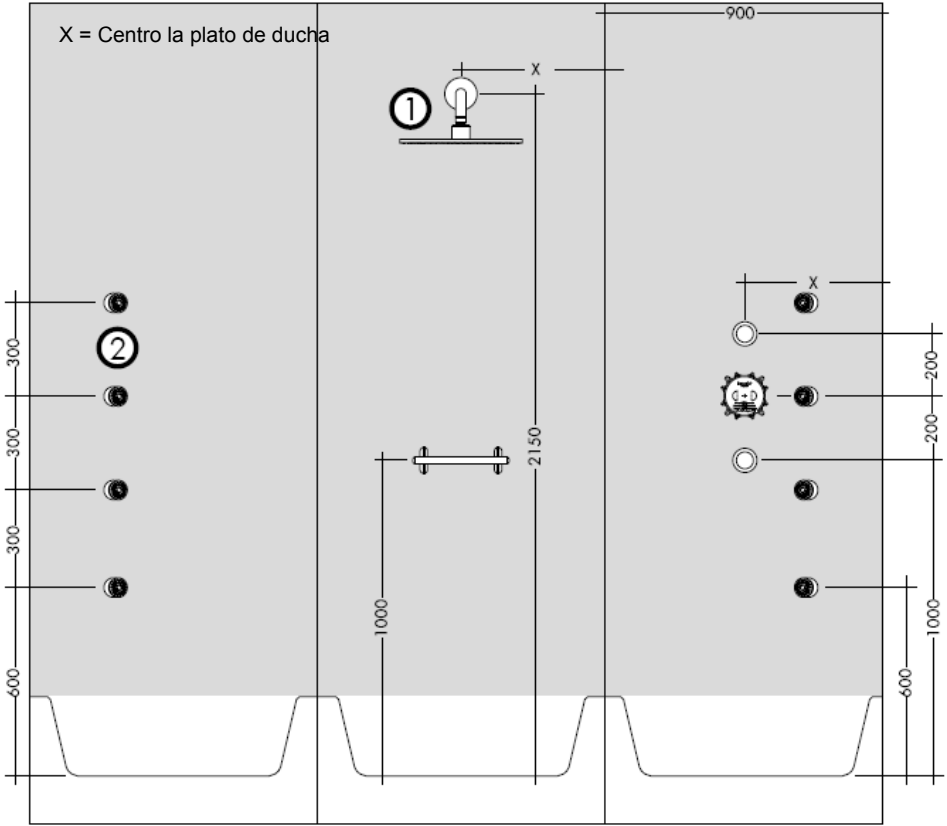

Área refuerzo necesario de la pared

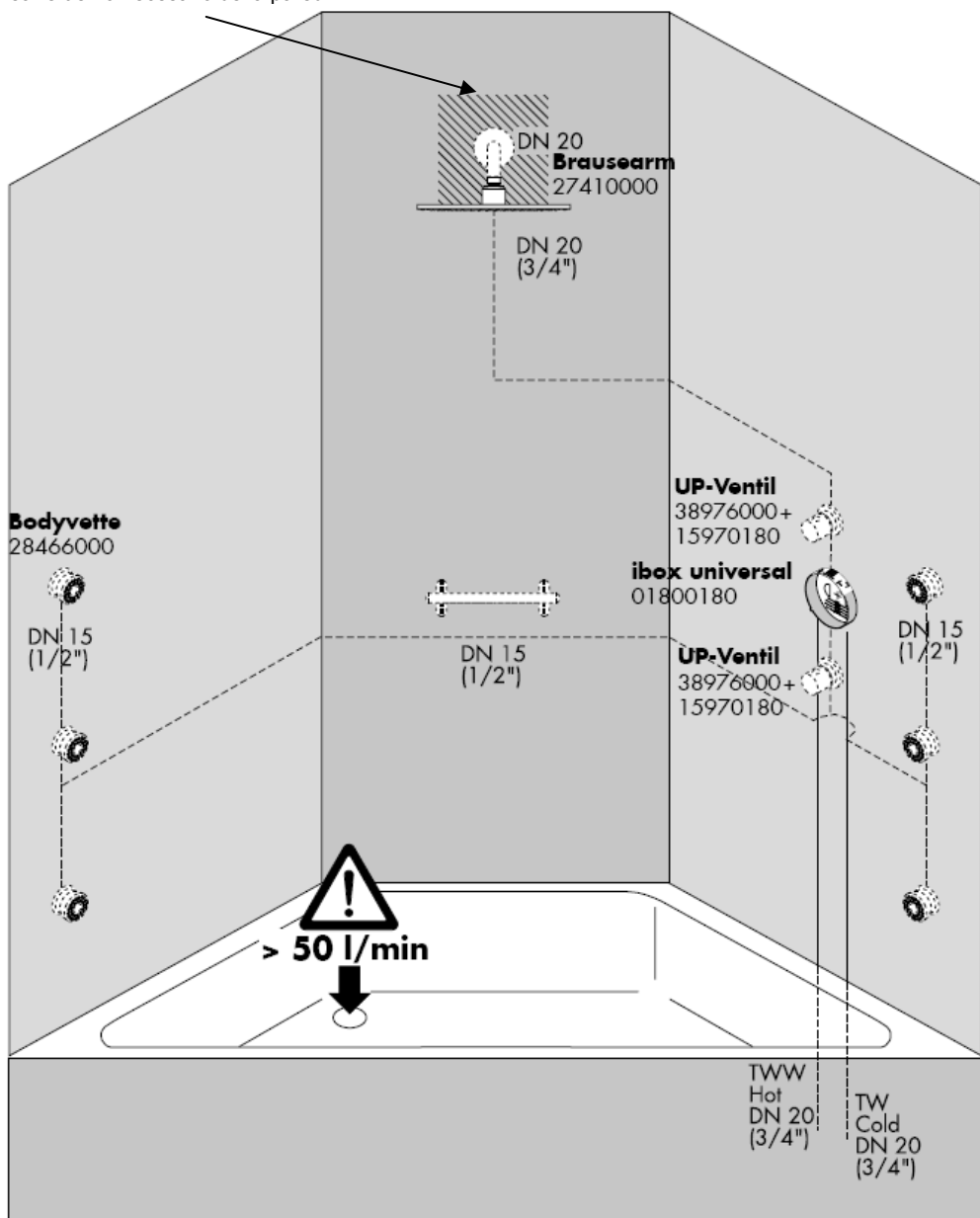

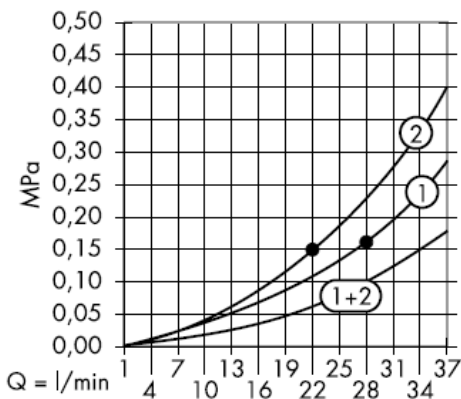

Mínimo • para el correcto funcionamiento.

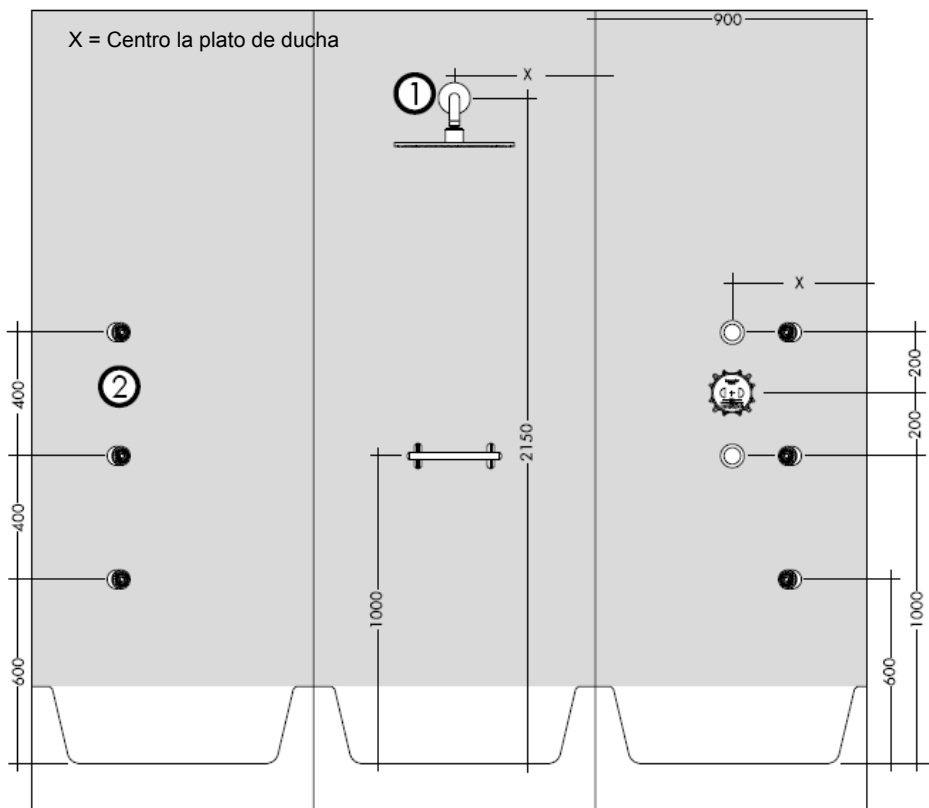

Área refuerzo necesario de la pared

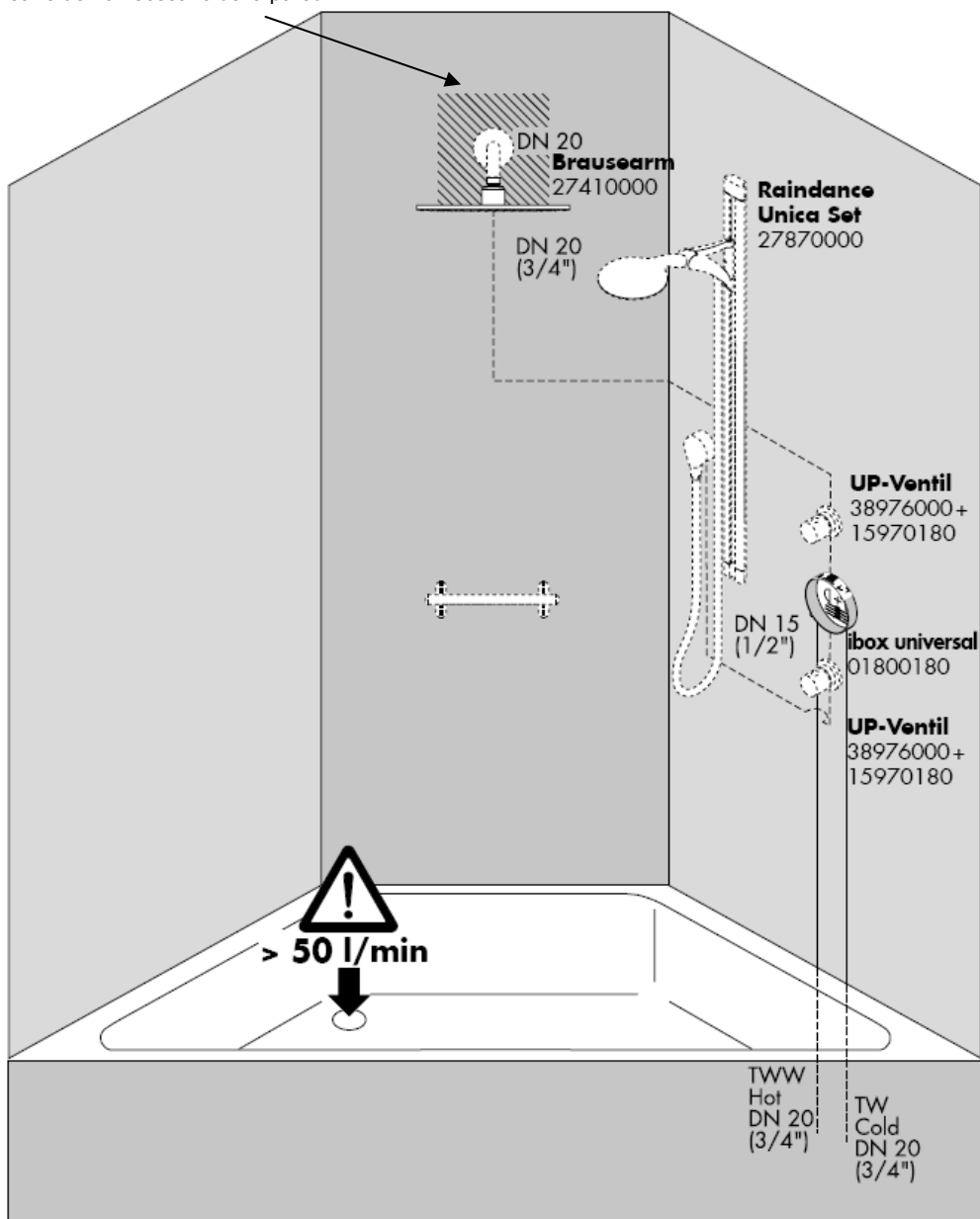

Área refuerzo necesario de la pared

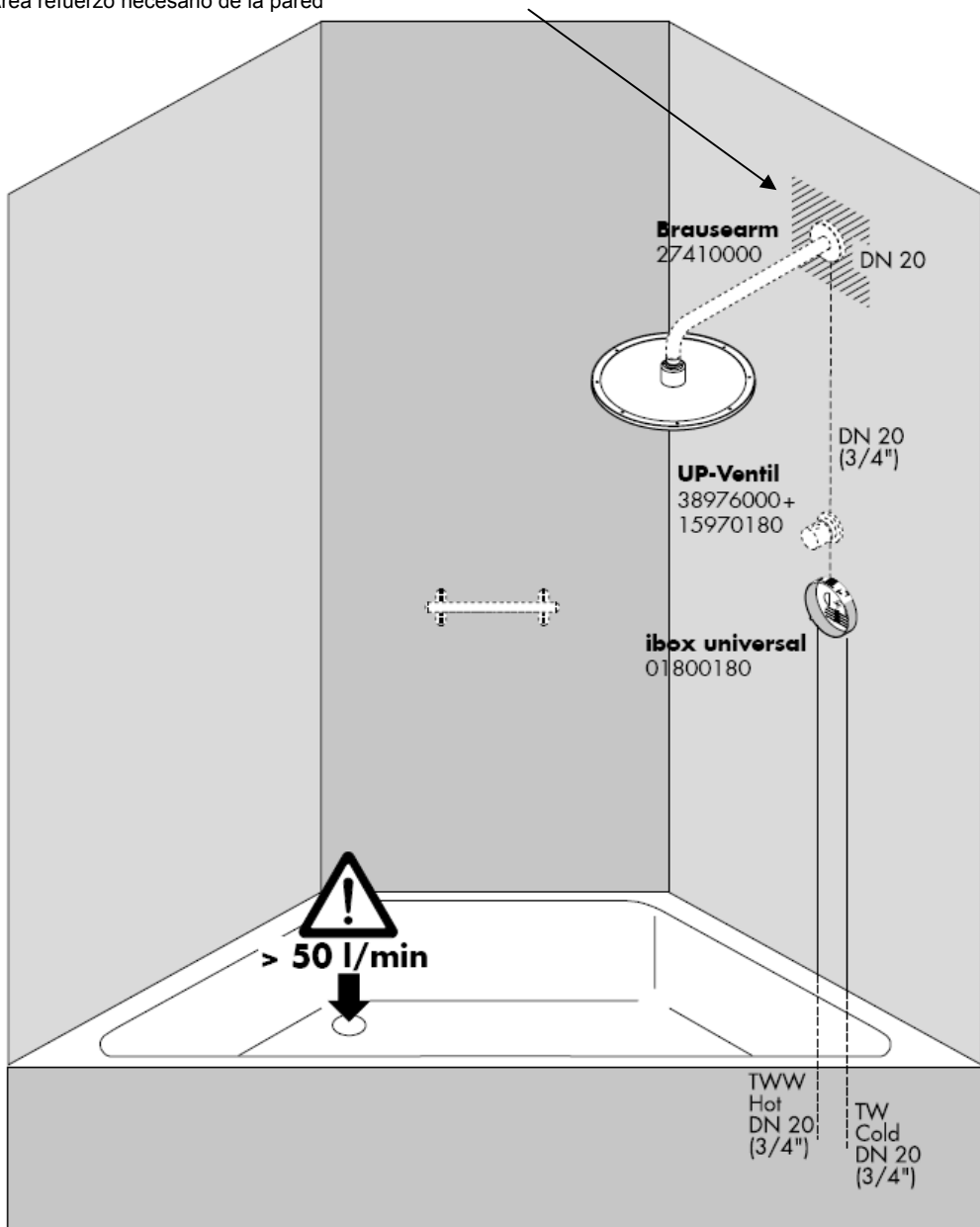

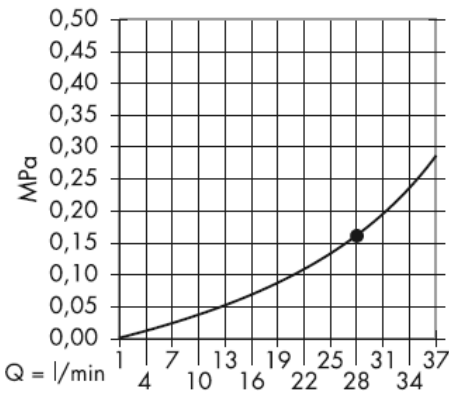

Mínimo • para el correcto funcionamiento.

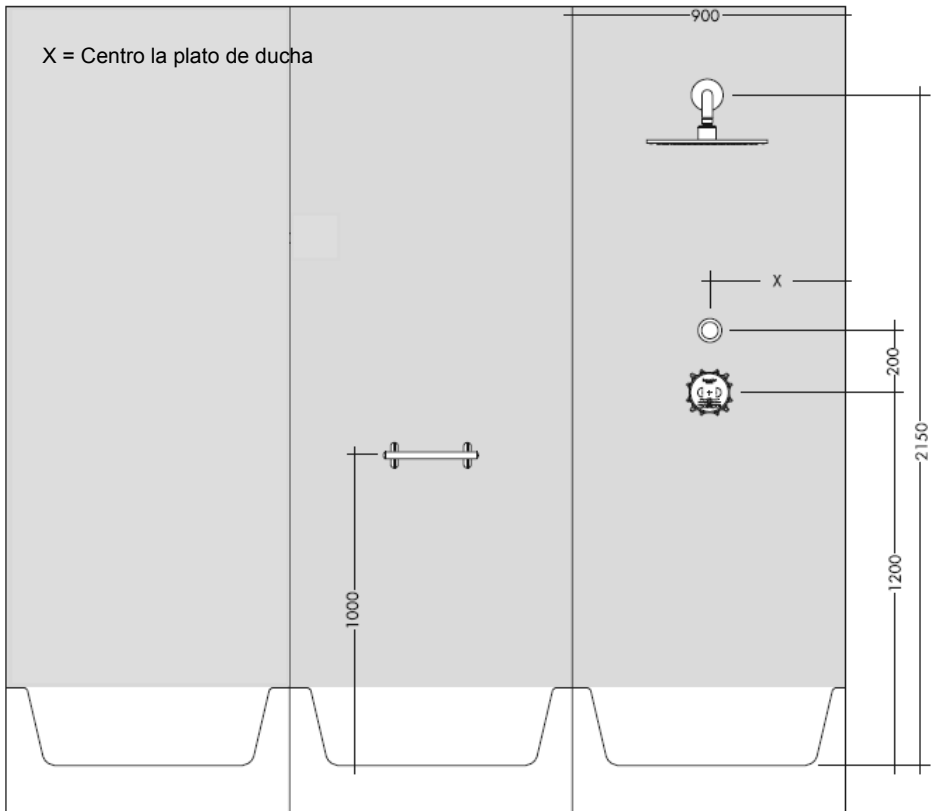

Área refuerzo necesario de la pared

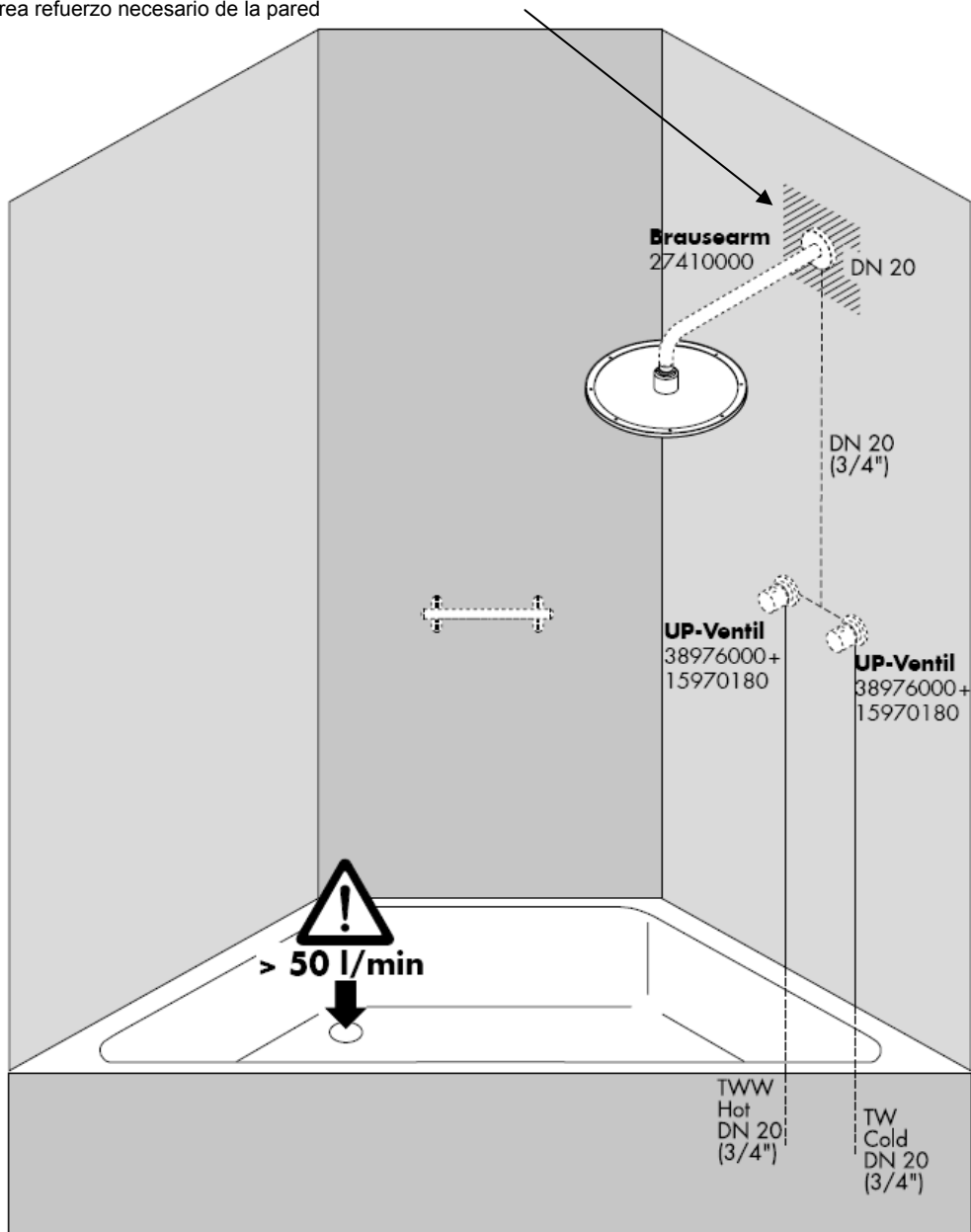

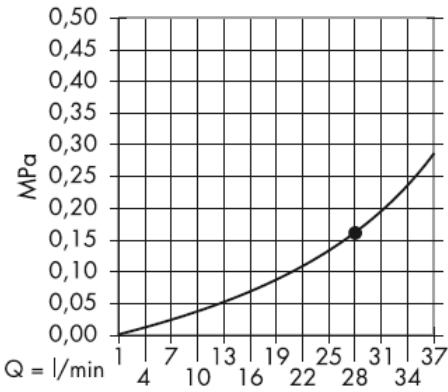

Mínimo • para el correcto funcionamiento.

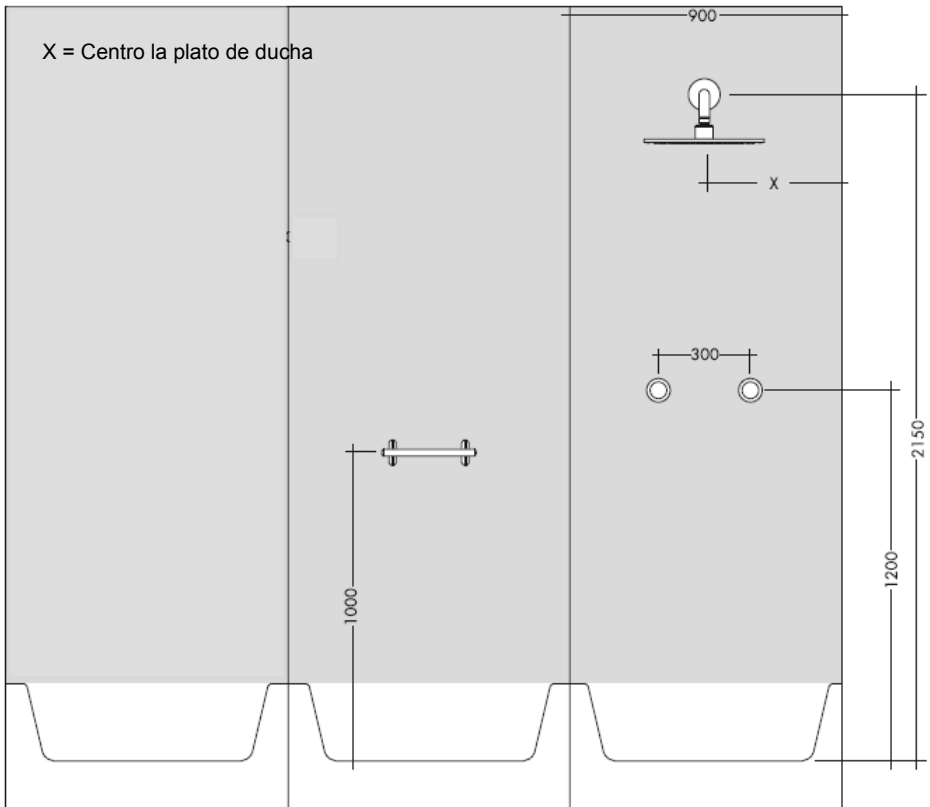

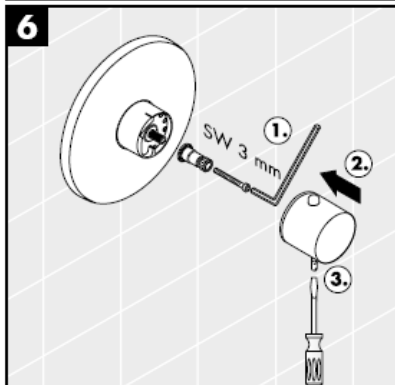
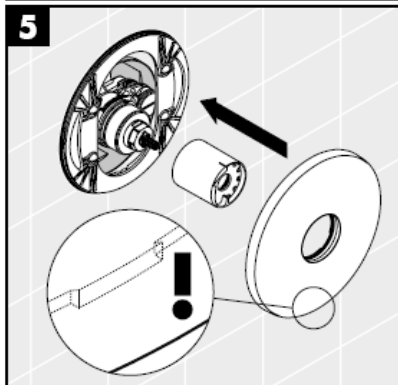
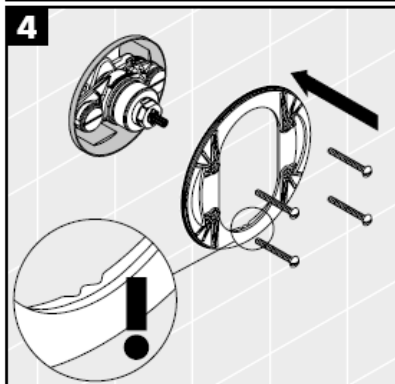
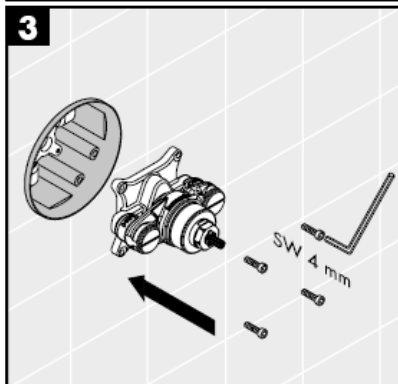
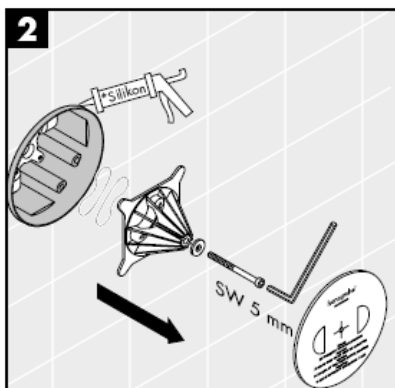
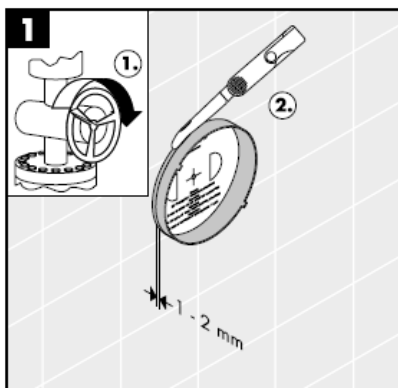

Silicona (¡libre de ácido acético!)

Gracias al tope de temperatura se puede graduar la temperatura máxima por ejemplo max. 42 C.

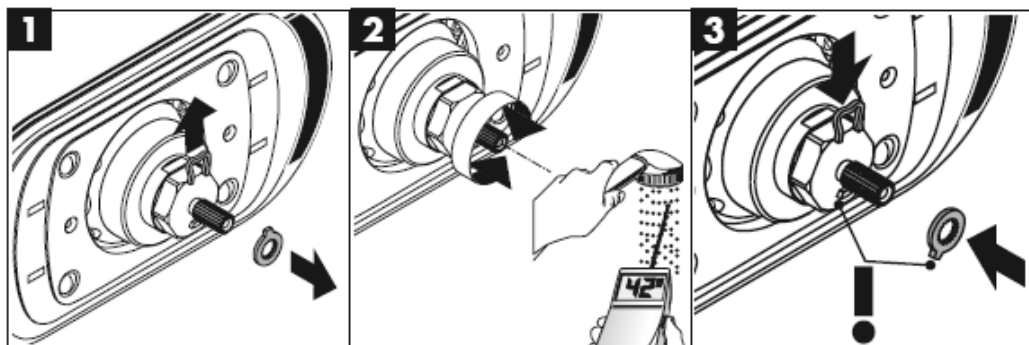

Puesta a punto

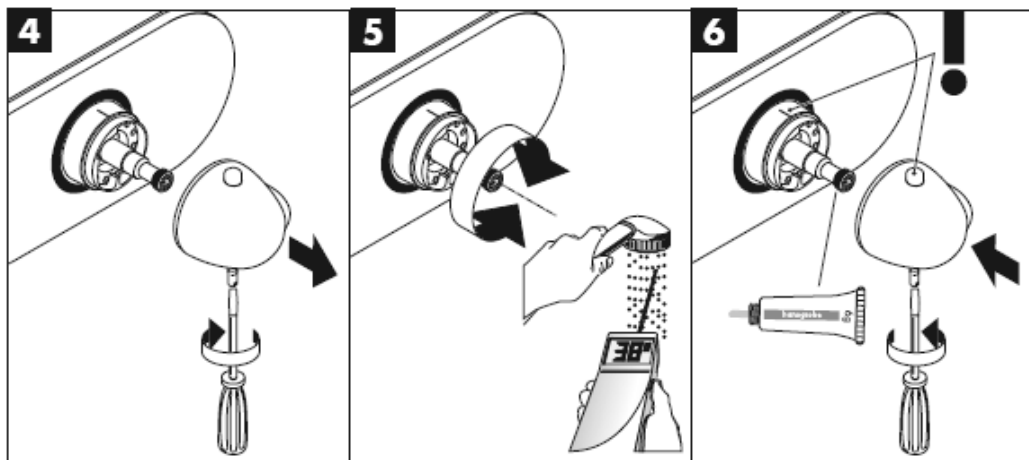



Si la ducha está en funcionamiento, tiene ésta junto con el brazo de la ducha un peso de aprox. 10 kg. Por este motivo, ¡sólo se puede utilizar un material de fijación apropiado para la mampostería! Los tornillos y tacos adjuntos sólo son apropiados para m

¡Sólo se puede utilizar un material de fijación apropiado para la mampostería! Los tornillos y tacos adjuntos sólo son apropiados para mampostería maciza

La tubería de desagüe ha de tener una dimensión suficiente.

Sólo se garantiza una función óptima en combinación con High Flow termostato Hansgrohe.

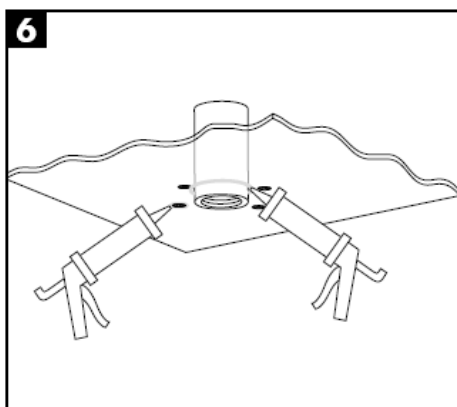
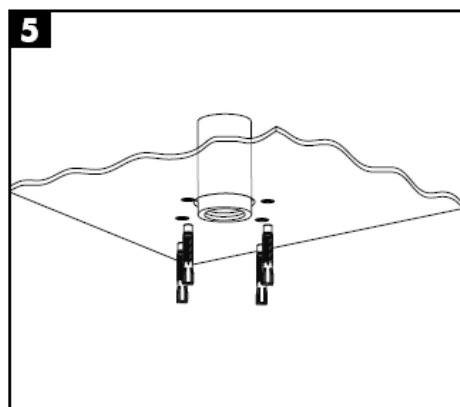
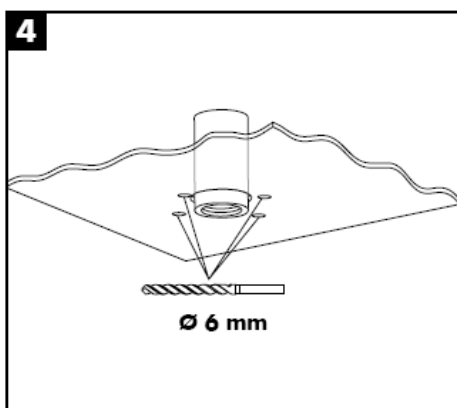
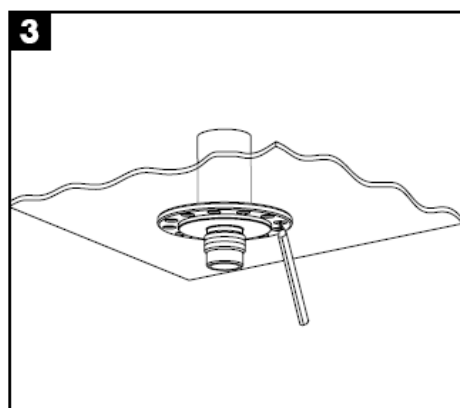
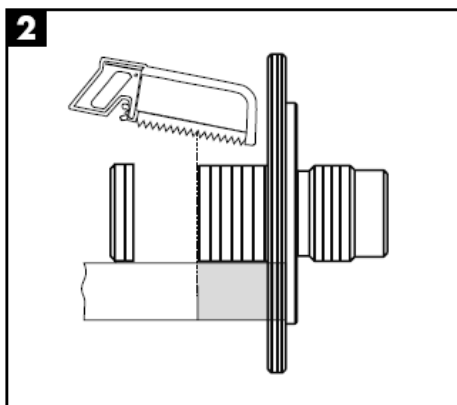
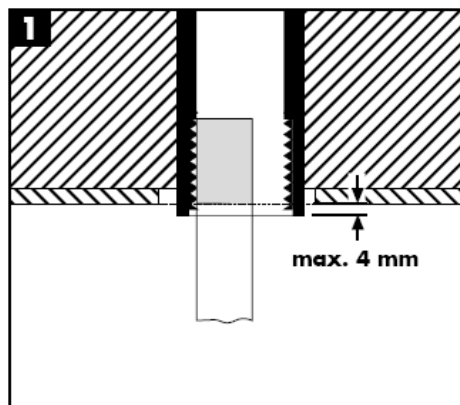

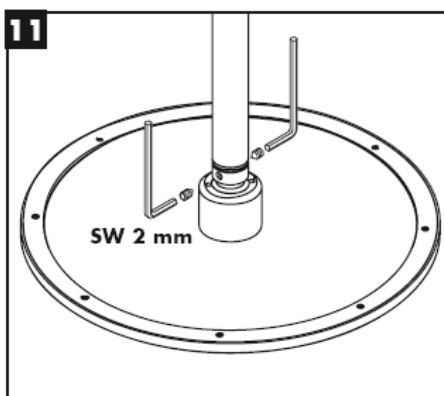
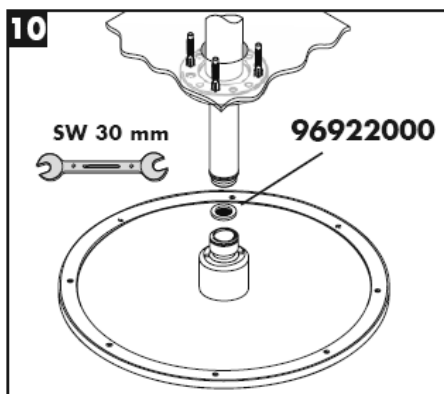
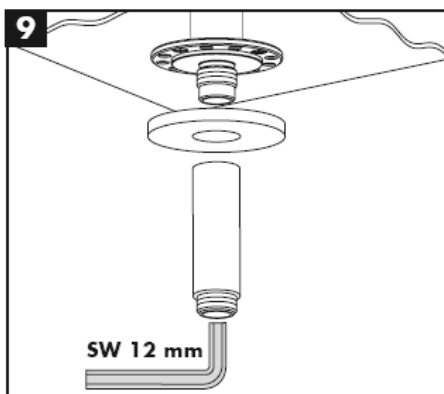
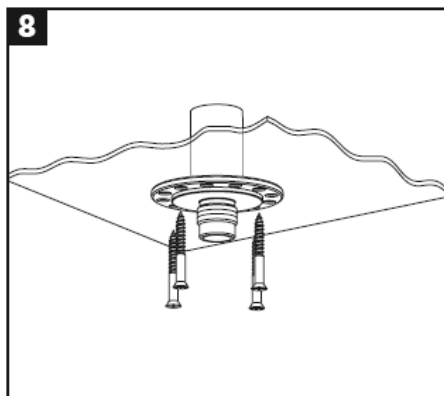
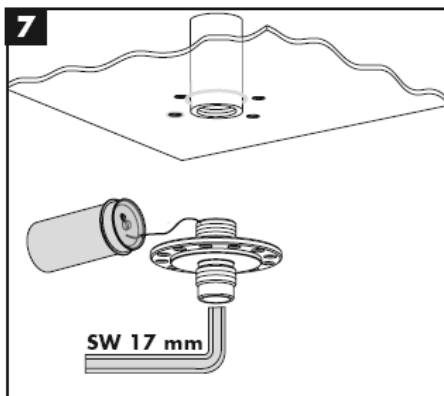

La junta de filtración que se suministra con la ducha mural evita que las partículas de suciedad procedentes de las tuberías lleguen a la ducha mural. Debe colocarse entre el flexo y la ducha mural. Infiltraciones de suciedad deterioran el funcionamiento de la ducha mural y pueden causar daños en el interior de la misma que no están cubiertas por la garantía de Hansgrohe.

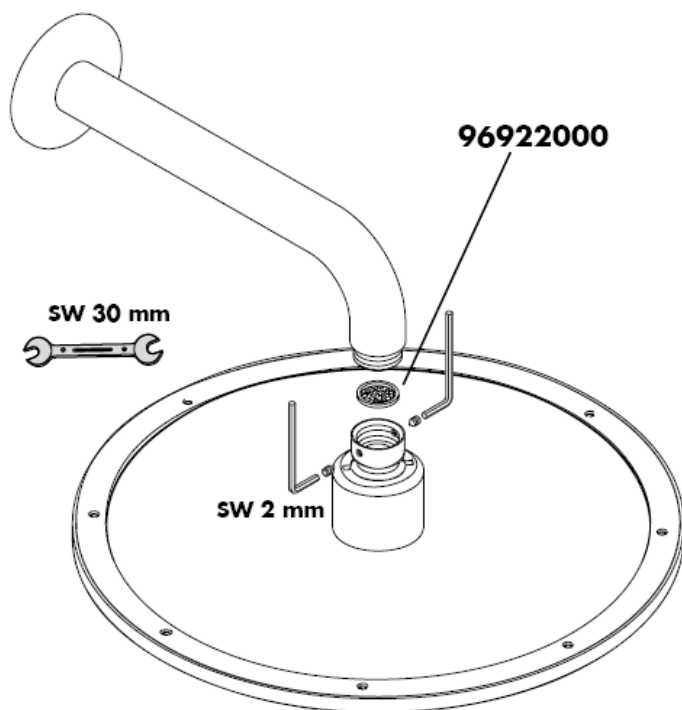

Montaje

¡Atención! El grifo tiene que ser instalado, probado y testado, según las normas en vigor.

Puesta a punto

Un ajuste de temperatura deberá efectuarse siempre y cuando la temperatura del agua tomada en la salida no coincida con la que marque el mando. Al hacerse el ajuste se debe tener en cuenta lo siguiente: girar el mando (con la indicación de los grados) hasta que la temperatura del agua en la salida sea de 38 °C. Desenroscar el tornillo que sujeta el mando. Retirar el mando y girar hasta la posición de 38 °C. Volver a colocar el mando y atornillarlo (ver página 22).

Limitación de la temperatura

El radio de giro del volante está bloqueado a los 38 °C. Para rebasar esta temperatura basta con oprimir el botón (tope de seguridad).

Safety Function

Gracias al tope de temperatura se puede graduar la temperatura máxima por ejemplo max. 42 °C. ver página 21.

Datos técnicos

Presión en servicio: max. 1 MPa
 Presión recomendada en servicio: 0,1 – 0,5 MPa
 Presión de prueba: 1,6 MPa
 (1 MPa = 10 bar = 147 PSI)
 Temperatura del agua caliente: max. 80 °C
 Temp. recomendada del agua caliente: 65 °C
 Caudal máximo: ca. 58 l/min 0,3 MPa

Mantenimiento

Los termostatos no precisan ningún tipo de mantenimiento especial. Las válvulas anti-retorno tienen que ser controladas regularmente según la norma DIN EN 1717, en acuerdo con las regulaciones nacionales o regionales (una vez al año, por lo menos). Conviene comprobar al mismo tiempo el filtro del termoelemento (6.1). Después de poner el termoelemento se ha de ajustar el termoelemento a la temperatura (ver "Puesta a punto"). Asegúrese de que el agua caliente esté conectada.

Para garantizar el funcionamiento duradero del termostato, el mando del mismo debería girarse de vez en cuando del extremo frío al extremo caliente.

Repuestos ver página 3

1	Mando del termostato	38391000
2	Embellecedor	96452000
3	Casquillo	97439000
4	Tornillo portador	96454000
5	Florón portador	96447000
6	Termoelemento	96633000
7	Filtro	97367000
8	Válvula antirretorno	96655000
9	Prolongación 25 mm	13595000
10	Prolongación 25 mm	13596000

Español

Problema	Causa	Solución
Sale poca agua	-presión insuficiente -filtro del termoelemento sucio -filtro de la ducha sucio	-comprobar presión -limpiar filtro -limpiar/cambiar filtros entre flexo y ducha
Flujo de agua cruzada agua caliente entra en la tubería del agua fría o al revés	-válvula antirretorno sucia o pierde	-cambiar válvula anti-retorno
Temperatura del agua no corresponde a lo marcado	-termostato no ha sido ajustado -temperatura del agua demasiado baja no hay	-ajustar termostato -aumentar temperatura del agua caliente a 42° - 65° C.
No es posible regular la temperatura	-termoelemento sucio/lleeno de cal -girar embellecedor en 180°	-cuerpo empotrado mal montado (debe estar: frío = derecha) o instalado girado en 180° -Botón de tope no funciona
muelle defecto	-Limpiar y aplicar una fina capa de grasa en el muelle y el pulsador -botón lleno de cal	-Limpiar y aplicar una fina capa de grasa en el muelle y el pulsador -Limpiar y aplicar una fina capa de grasa en el muelle y el pulsador

Marca de verificación

	P-IX	DVGW	SVGW	WRSA	KIWA	ACS	NF
27070000						X	
27418XXX							
28420000						X	
28435XXX						X	

Limpiar

Fácil aseo: La cal se puede retirar sencillamente frotando con los dedos de las toberas elásticas de silicona.

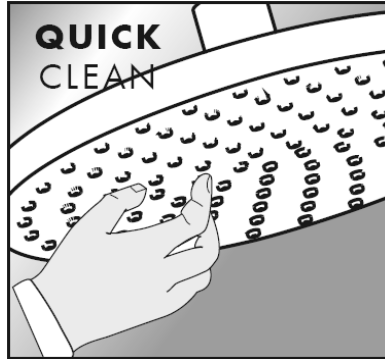

Entretimiento

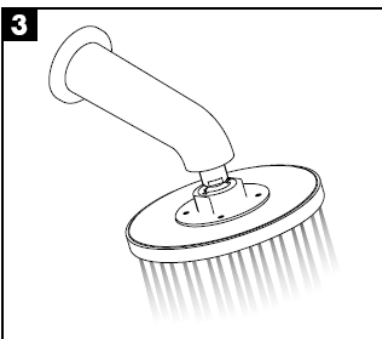
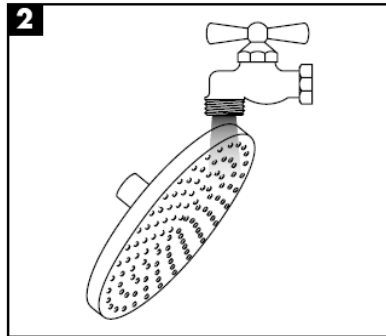
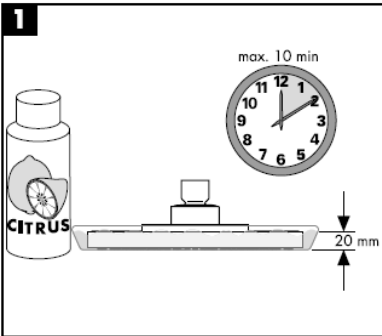

hansgrohe

Handleiding



27418XXX

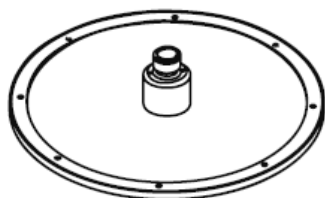

Raindance Royale AIR
28420000

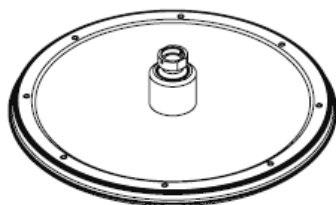

Raindance Royale Classic AIR
28435XXX

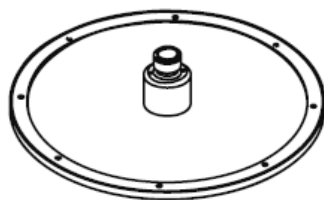

**Raindance Royale
High Flow Set**
27070000

hangrohe

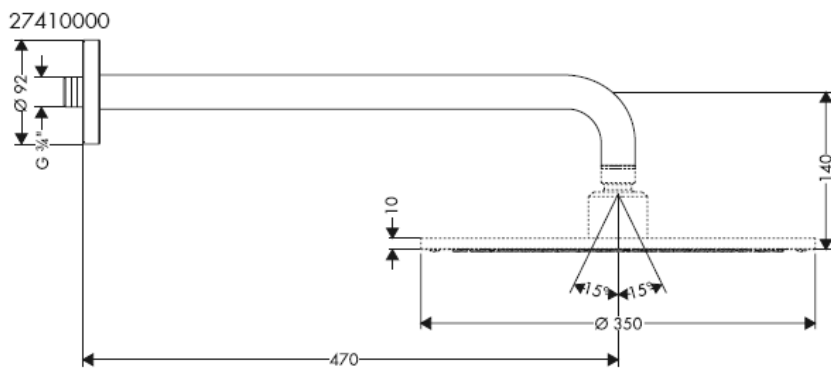
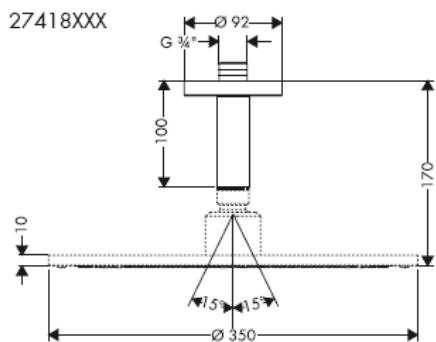
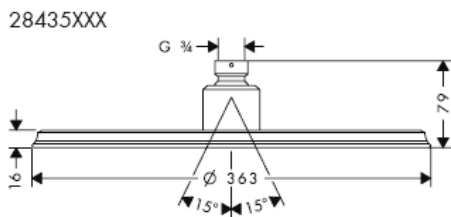
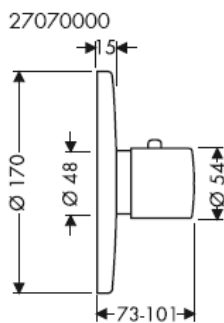
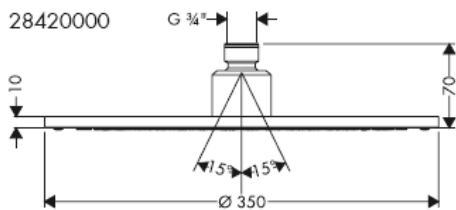

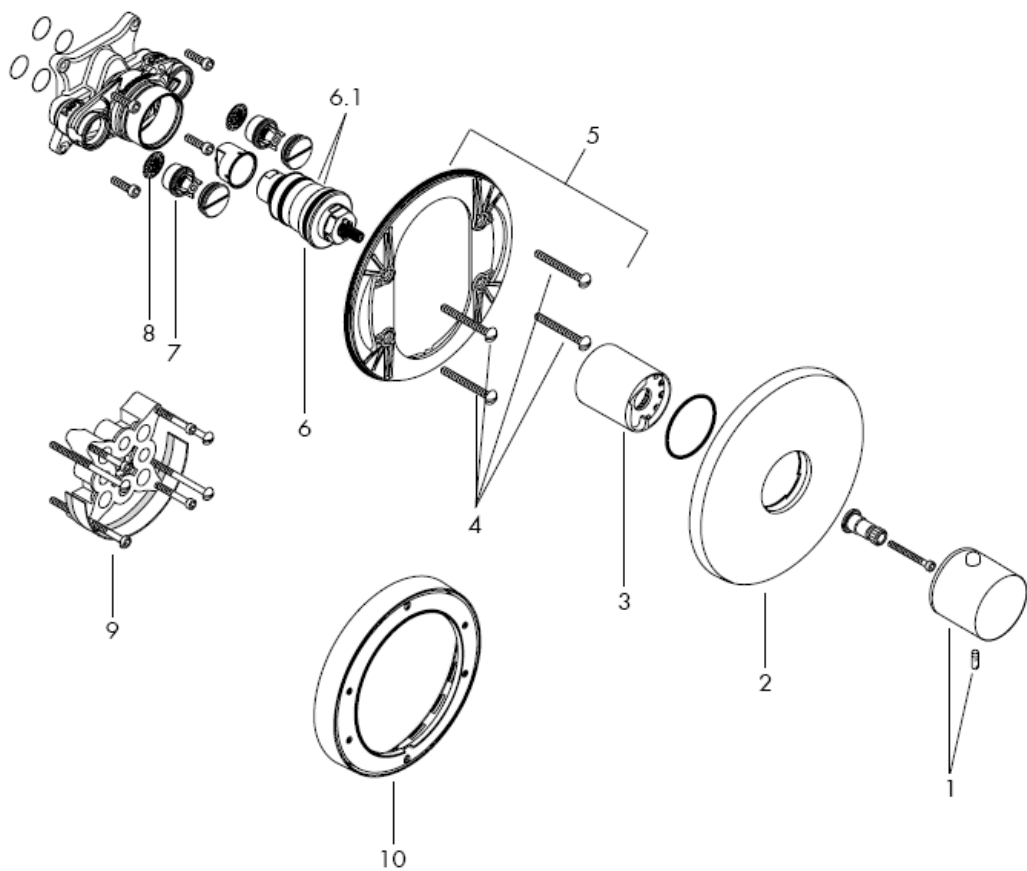

Maten indien mogelijk aan het tegelwerk aanpassen.

Wandversterking noodzakelijk v. Douchearm montage

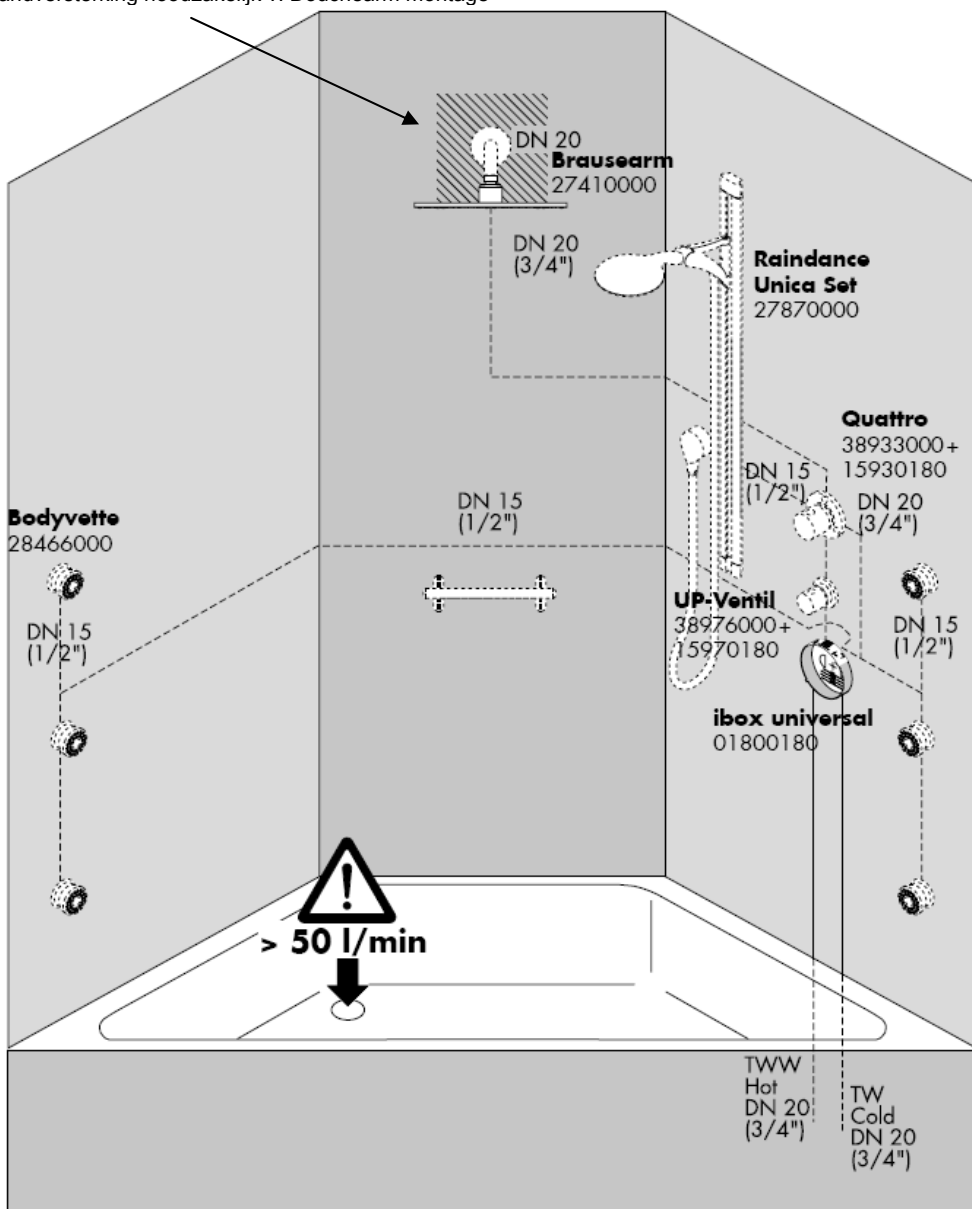

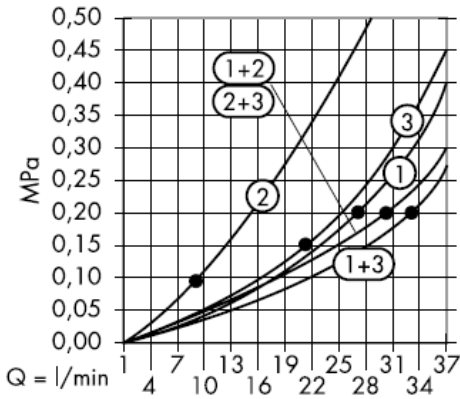

Vanaf • is het functioneren gegarandeerd.

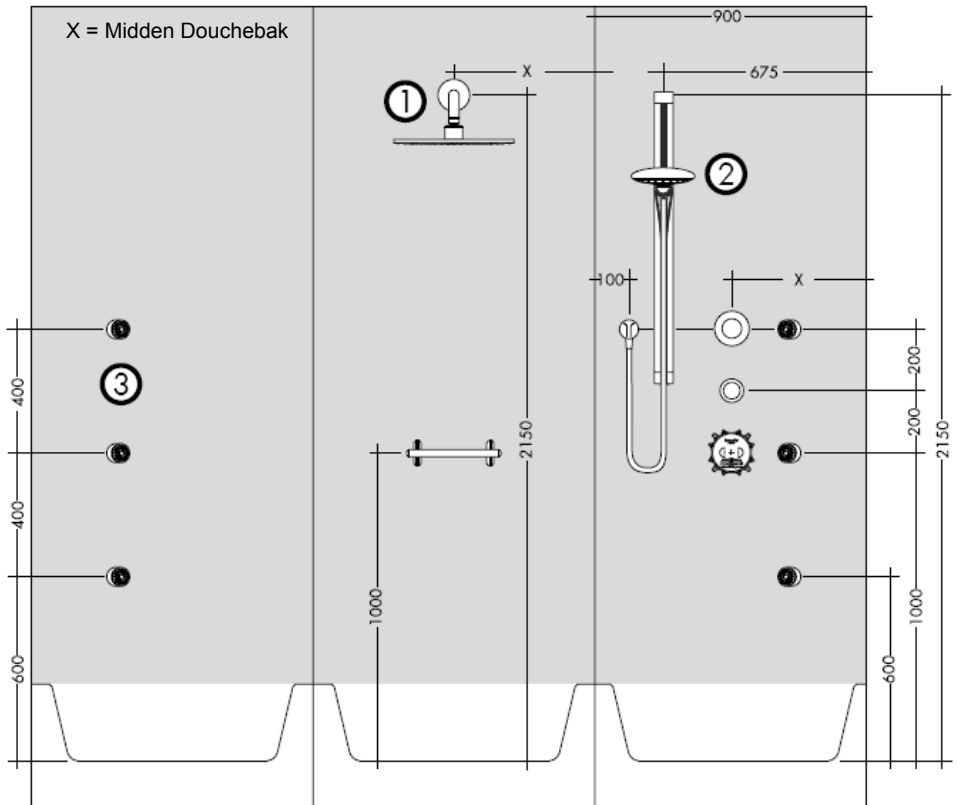

Wandversterking noodzakelijk v. Douchearm montage

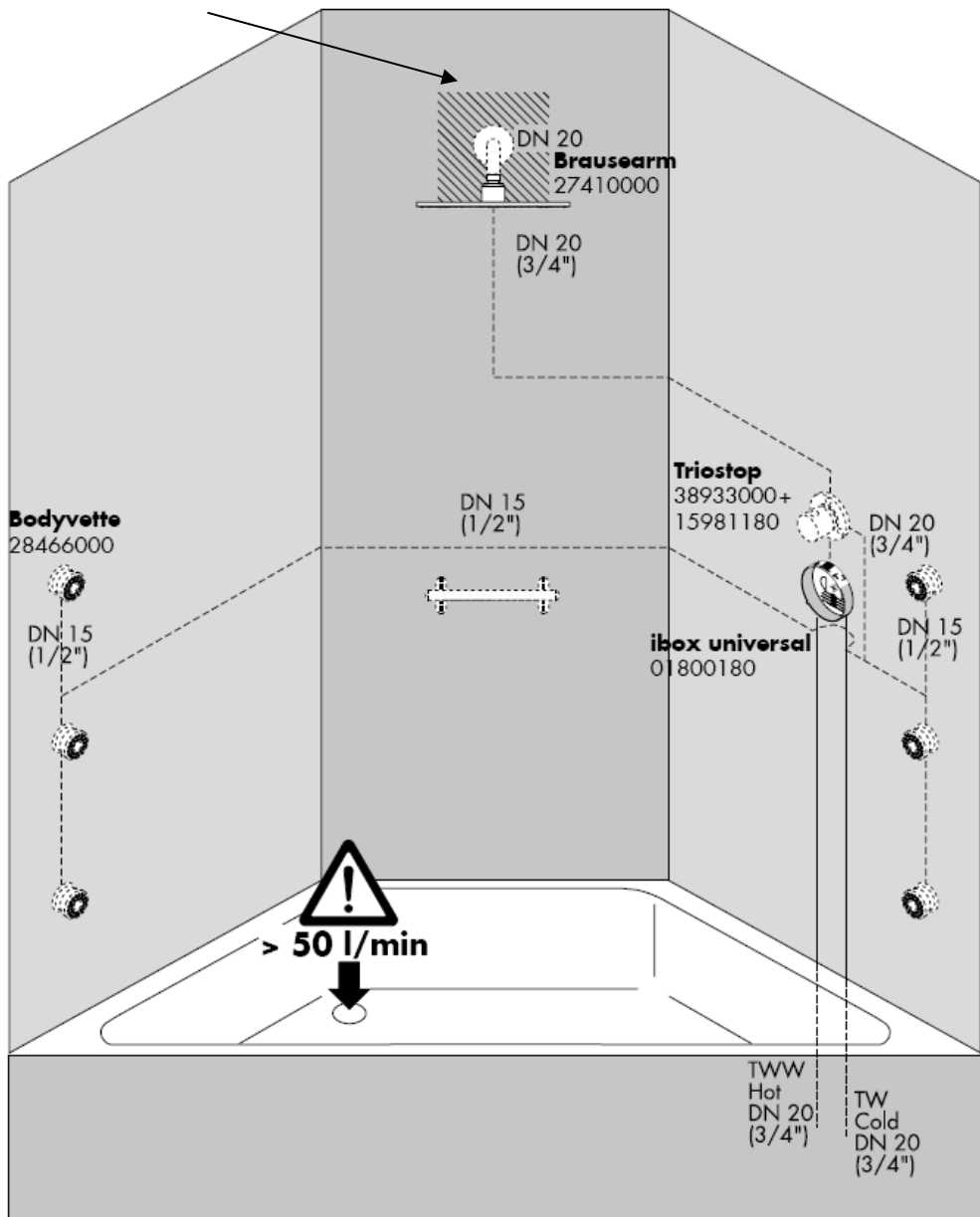

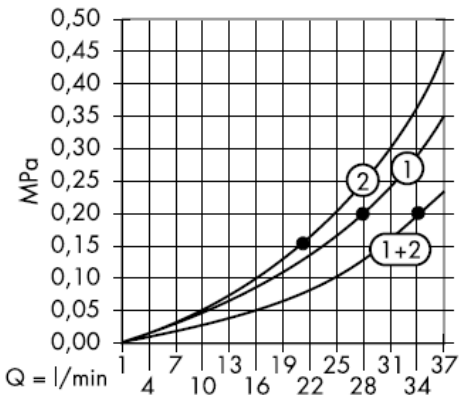

Vanaf • is het functioneren gegarandeerd.

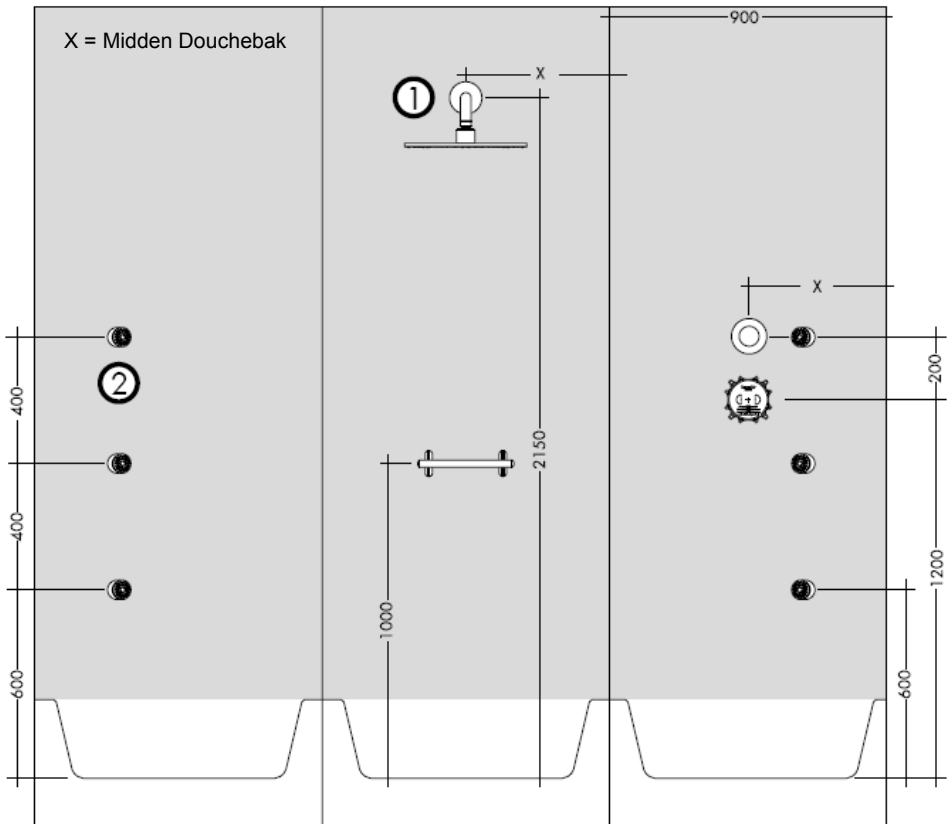

Wandversterking noodzakelijk v. Douchearm montage

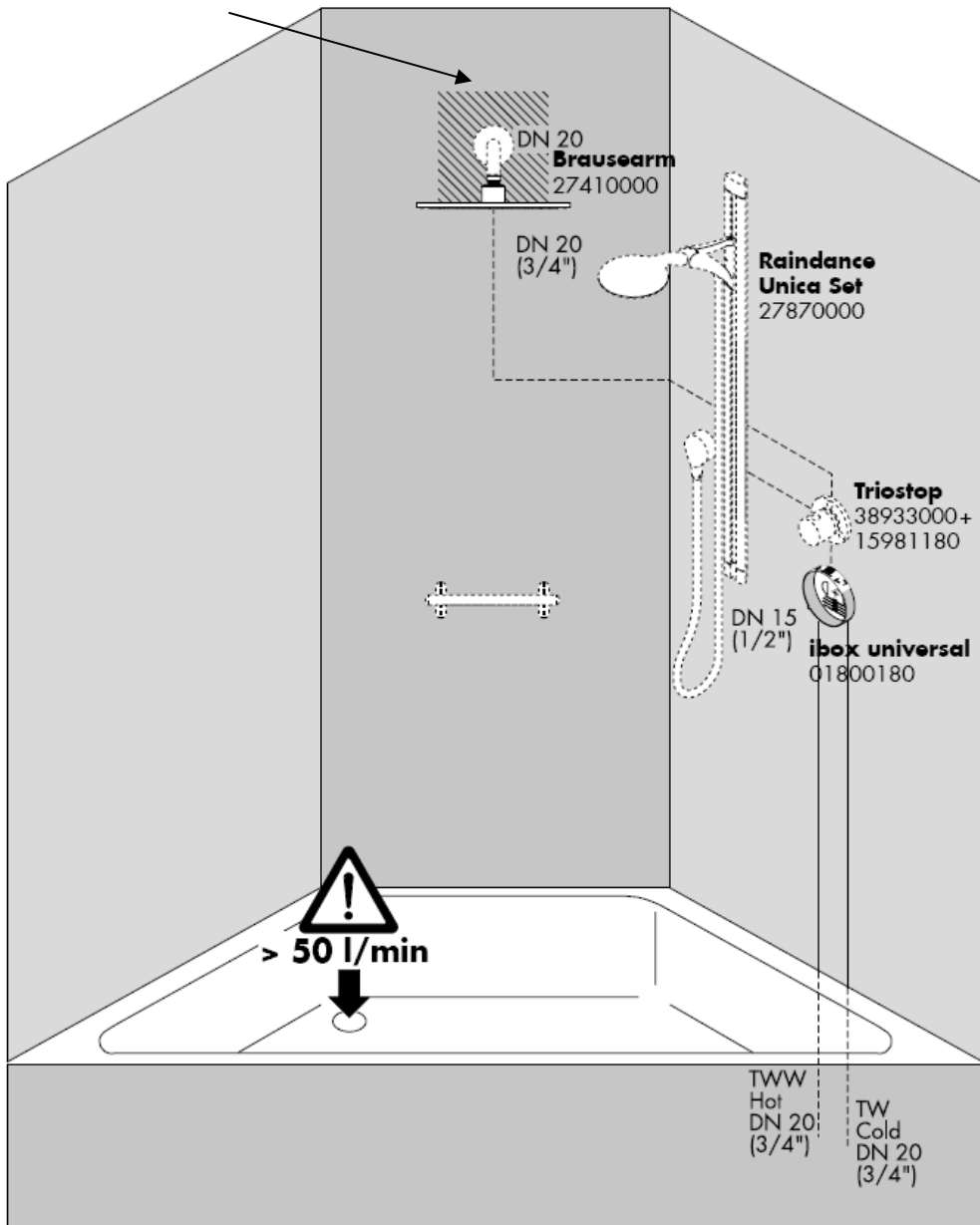

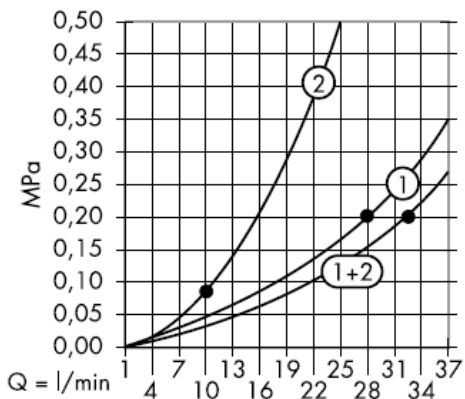

Vanaf • is het functioneren gegarandeerd.

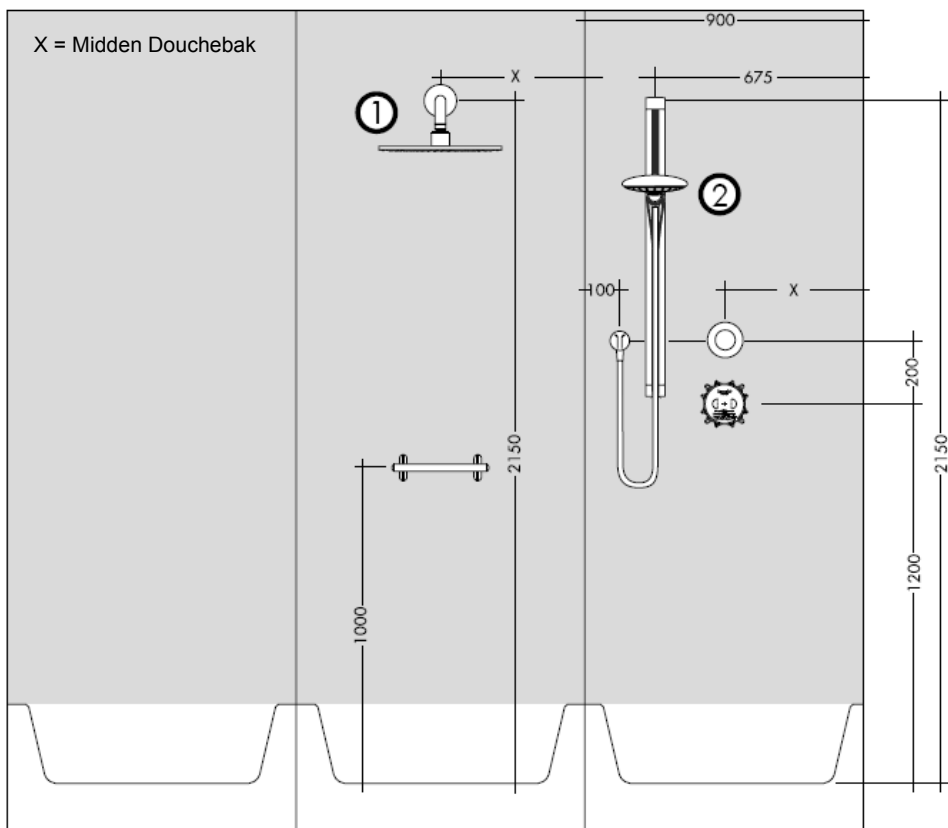

Wandversterking noodzakelijk v. Douchearm montage

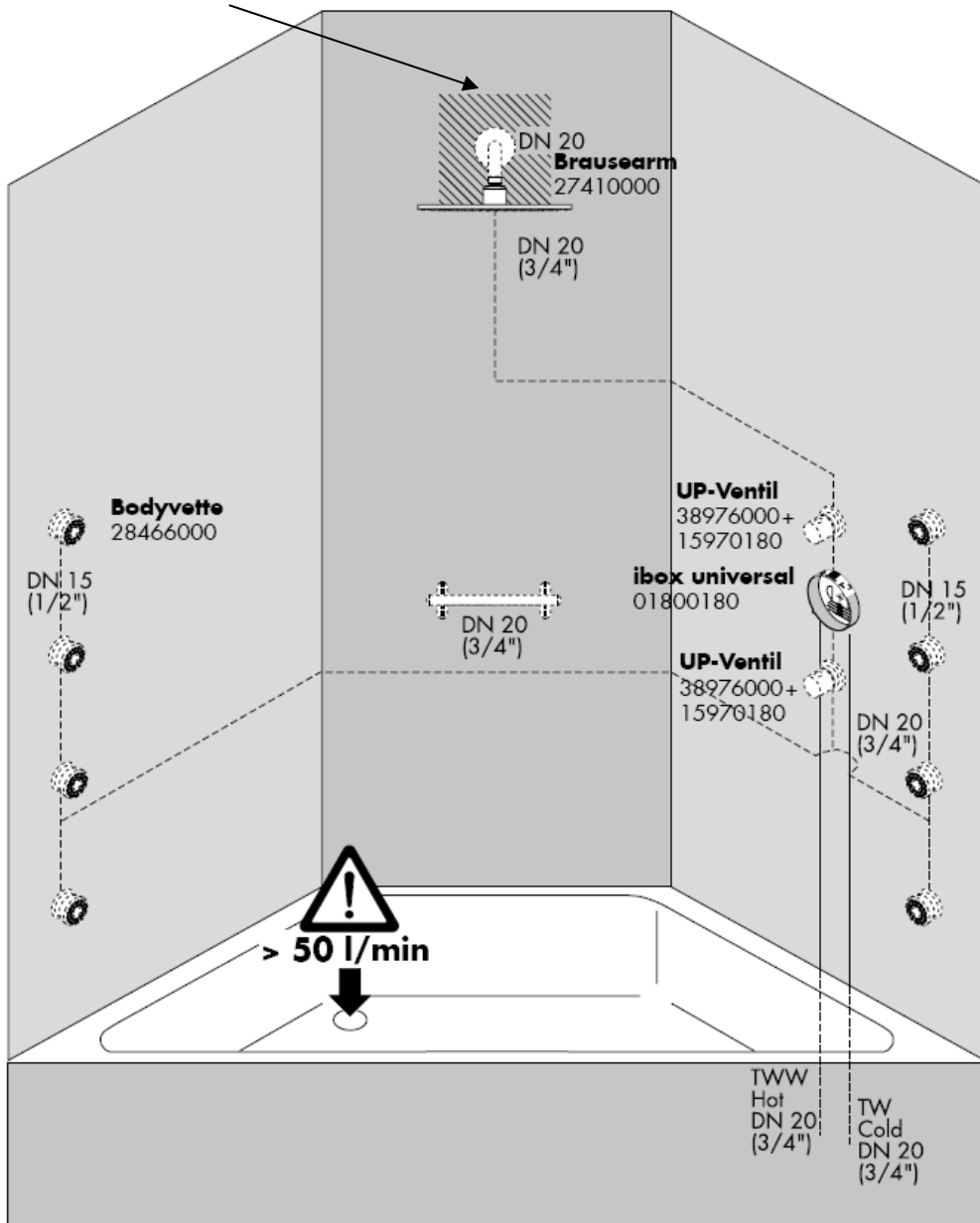

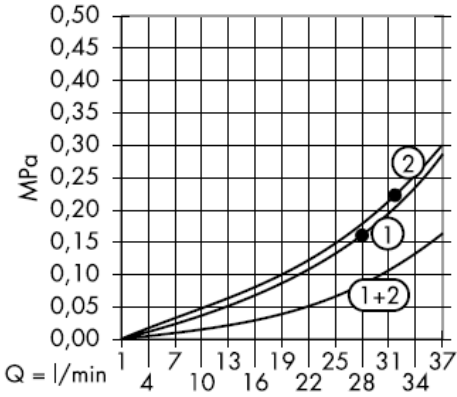

Vanaf • is het functioneren gegarandeerd.

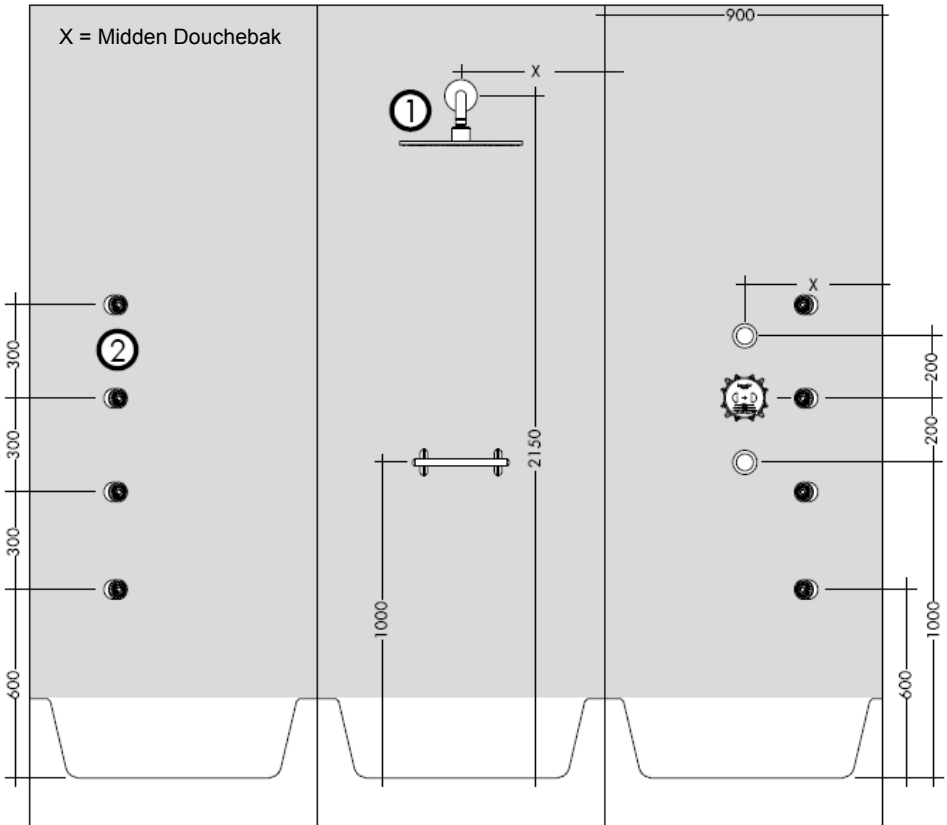

Wandversterking noodzakelijk v. Douchearm montage

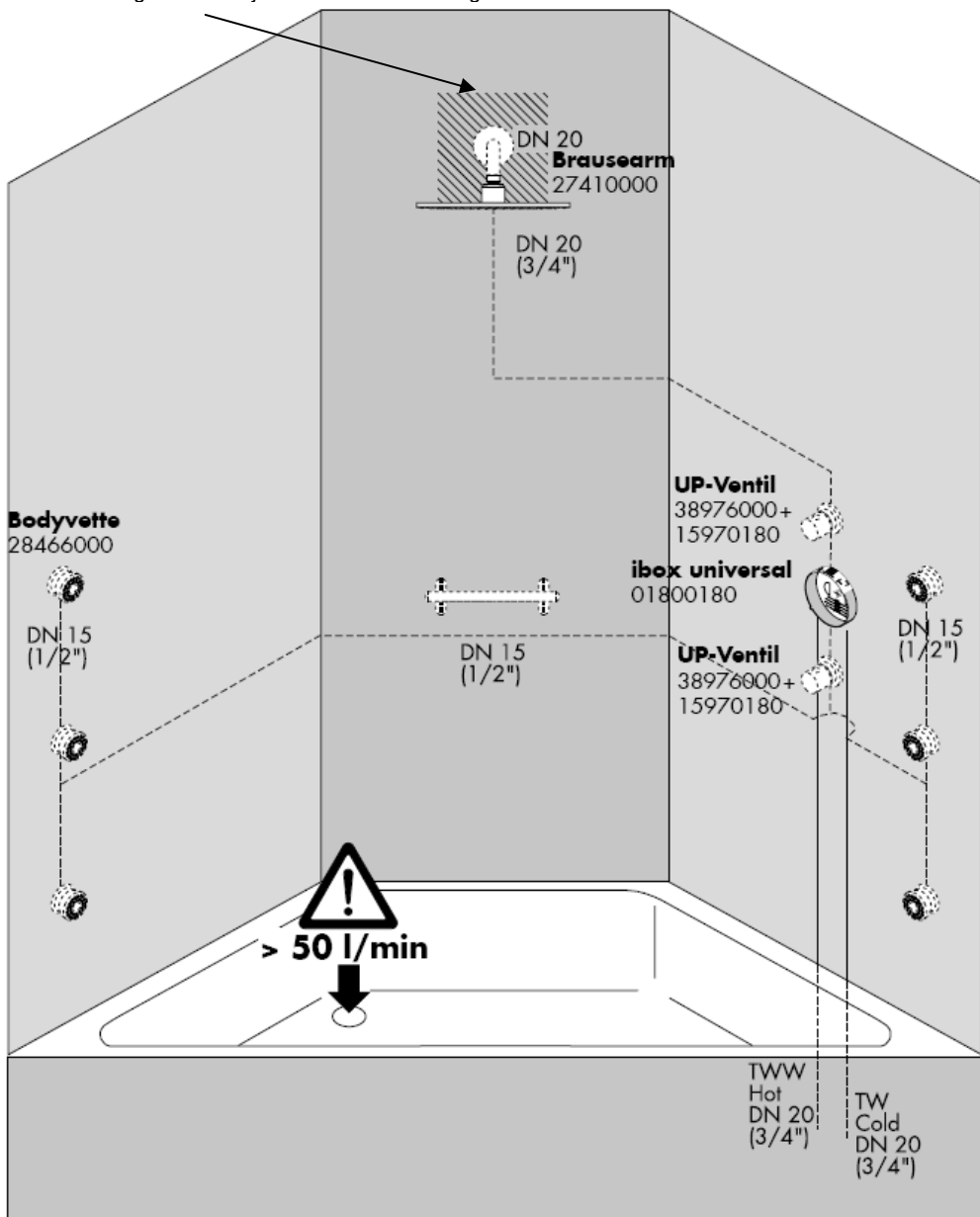

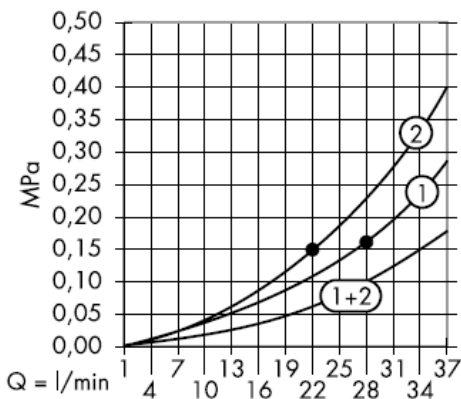

Vanaf • is het functioneren gegarandeerd.

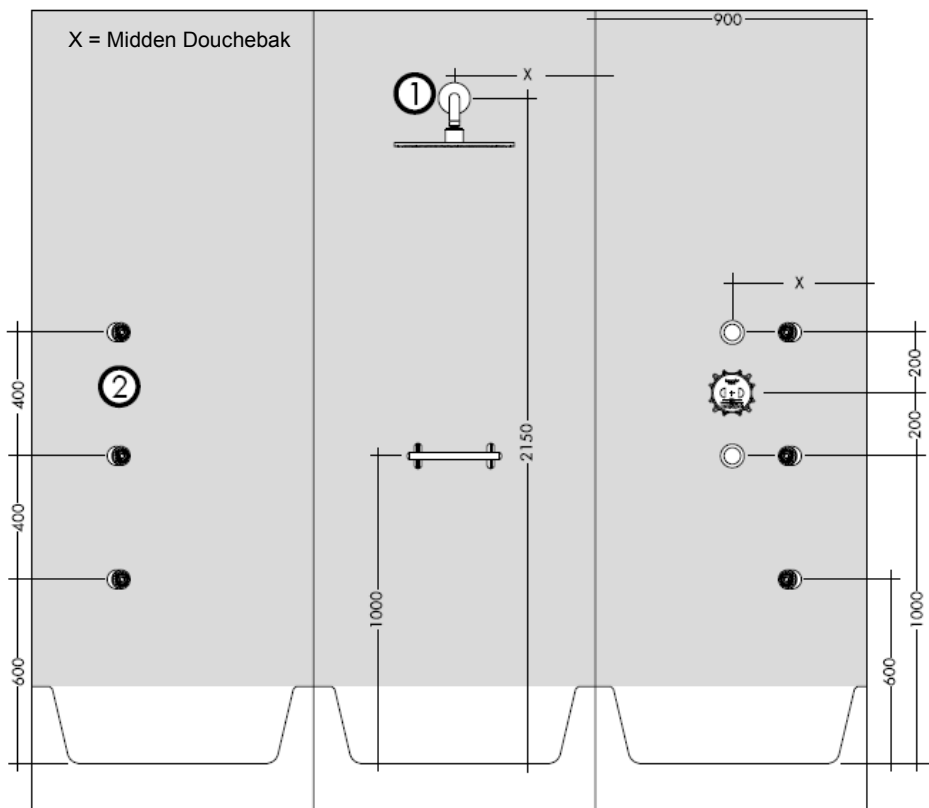

Wandversterking noodzakelijk v. Douchearm montage

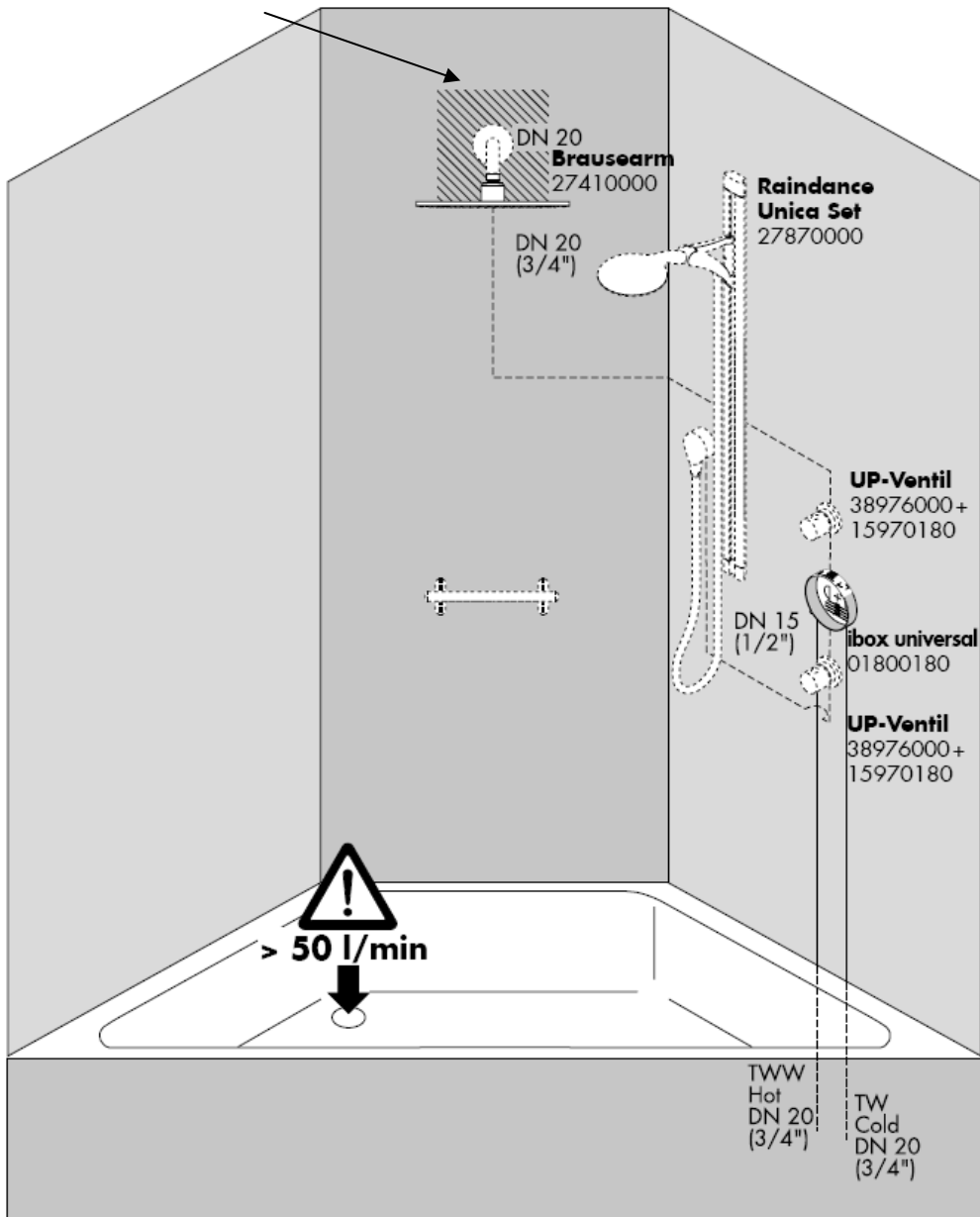

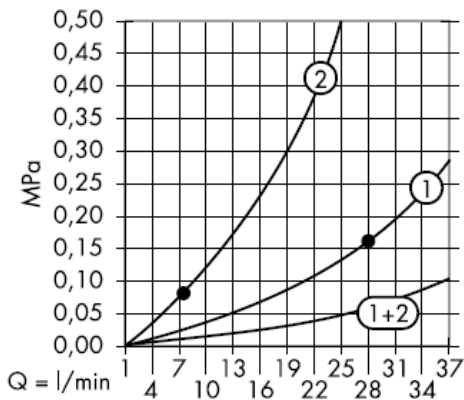

Vanaf • is het functioneren gegarandeerd.

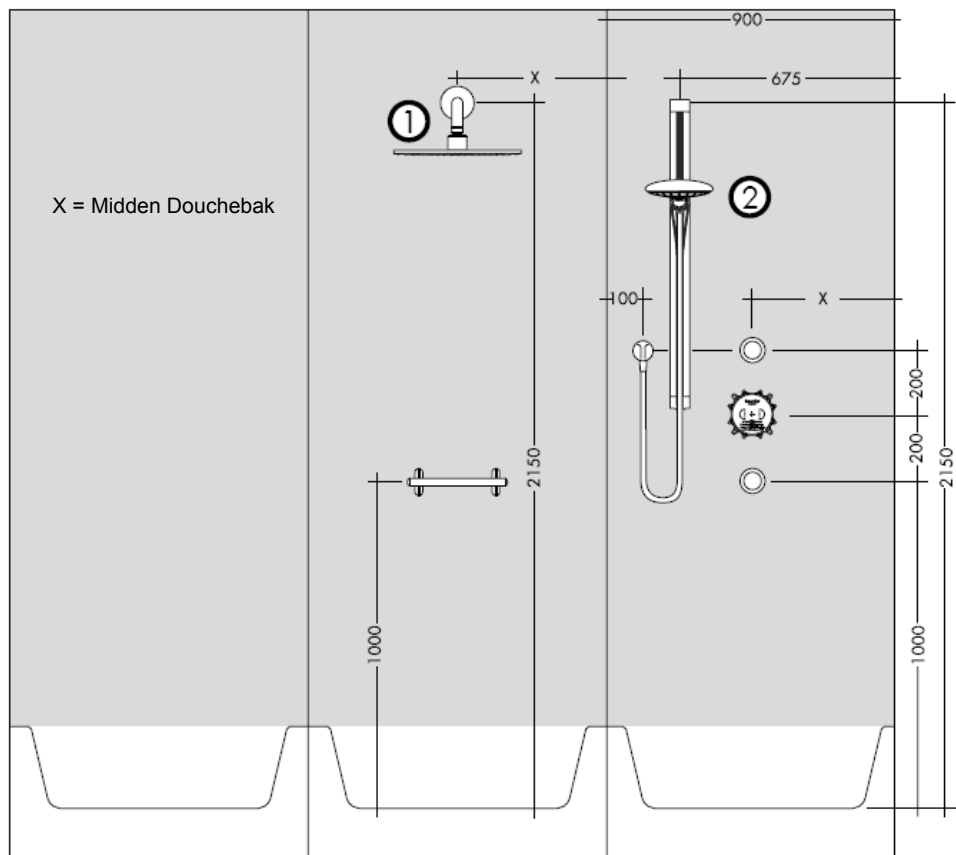

Wandversterking noodzakelijk v. Douchearm montage

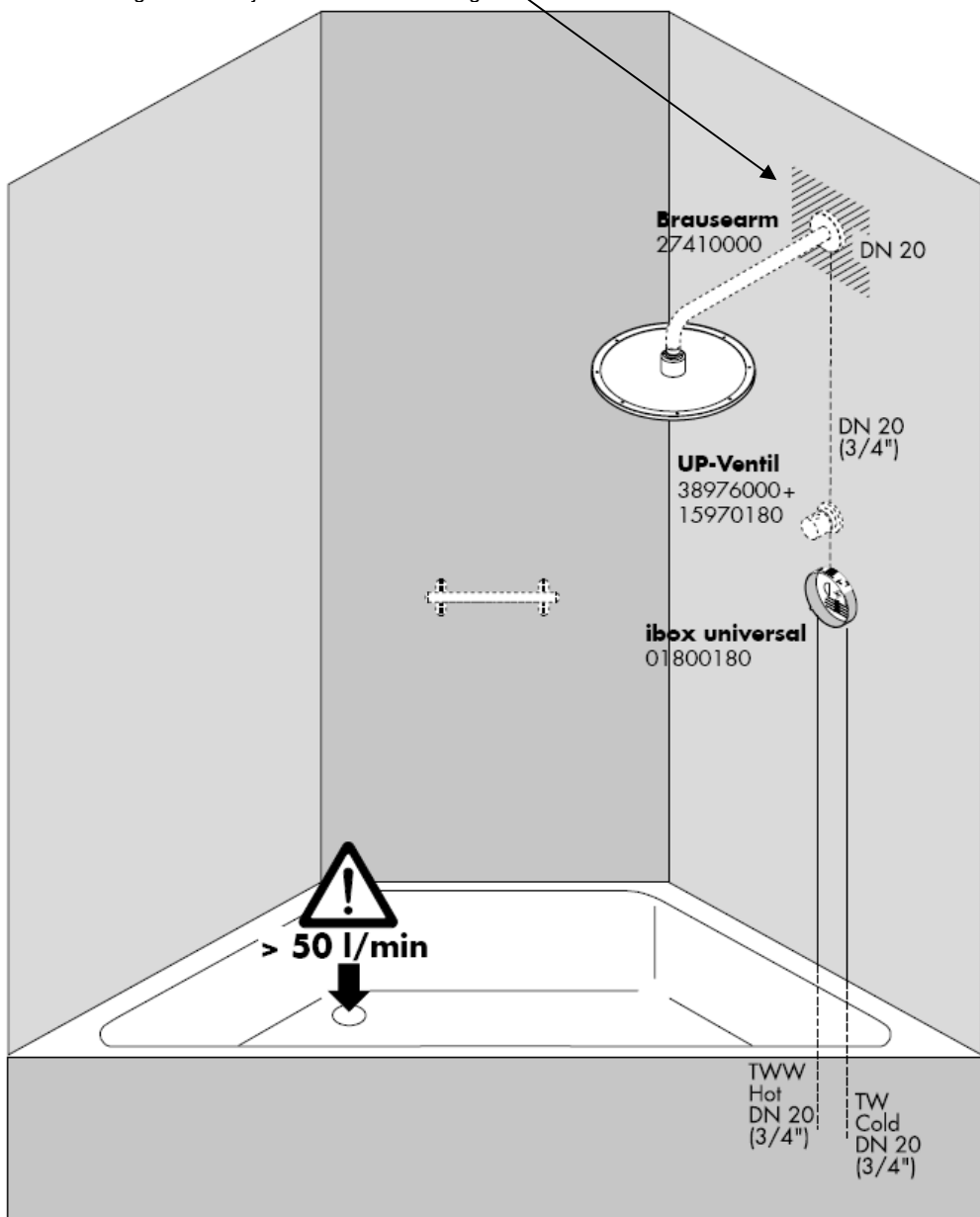

Vanaf • is het functioneren gegarandeerd.

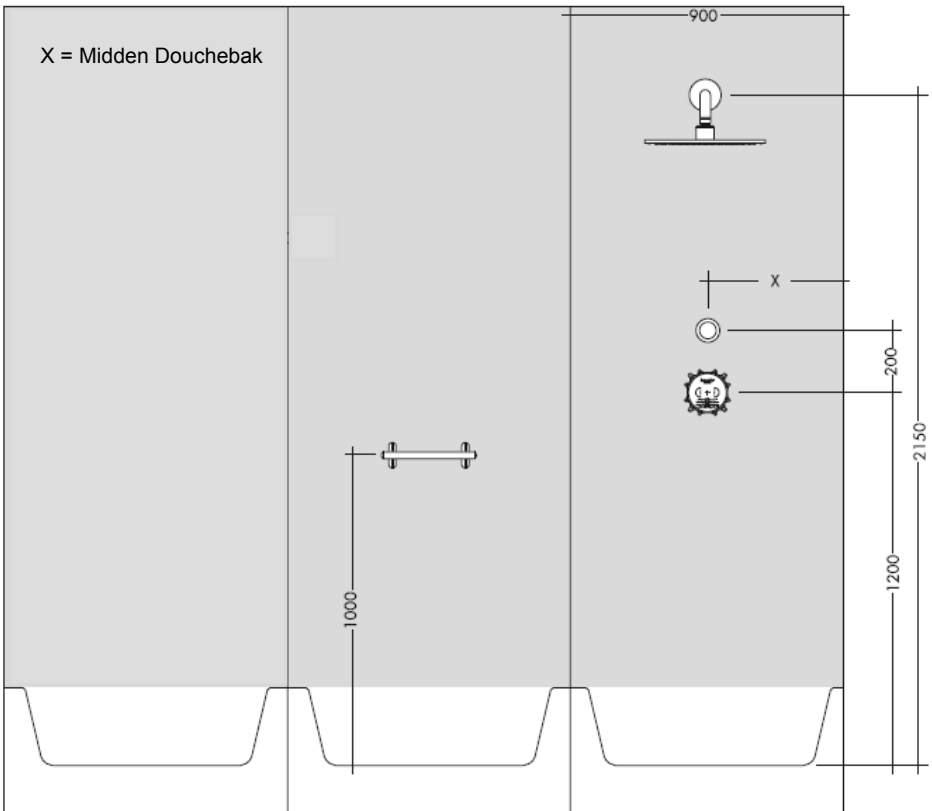
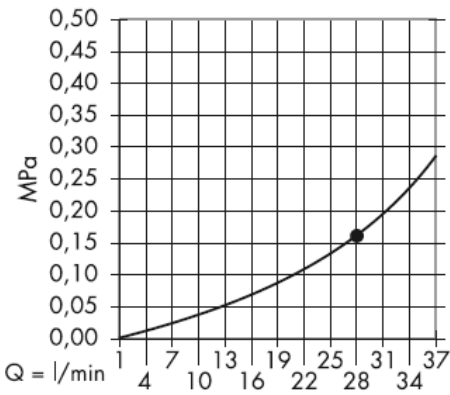

Wandversterking noodzakelijk v. Douchearm montage

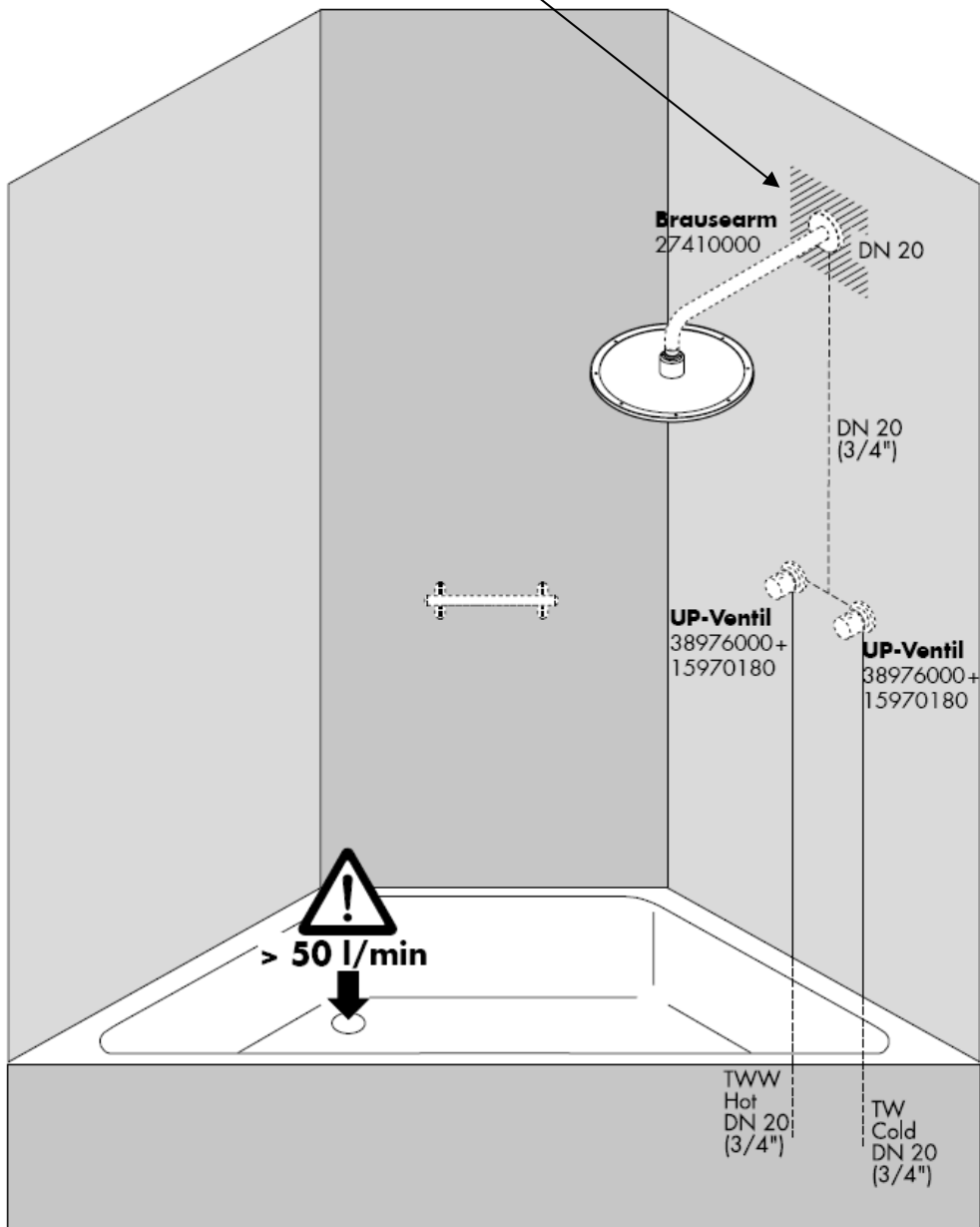

Vanaf • is het functioneren gegarandeerd.

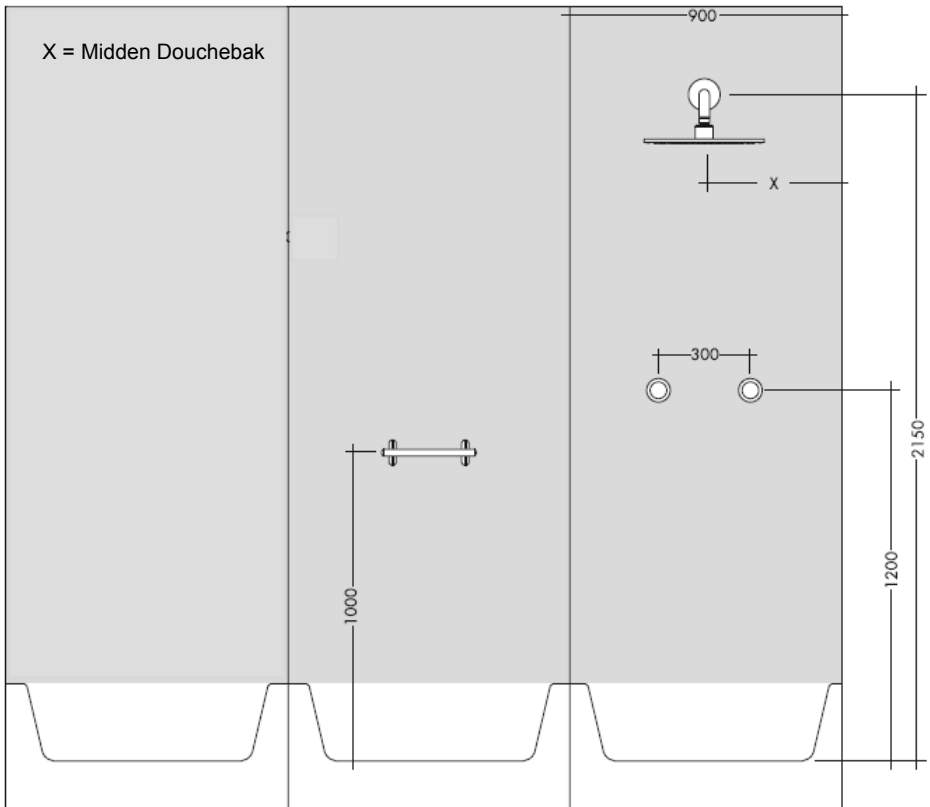
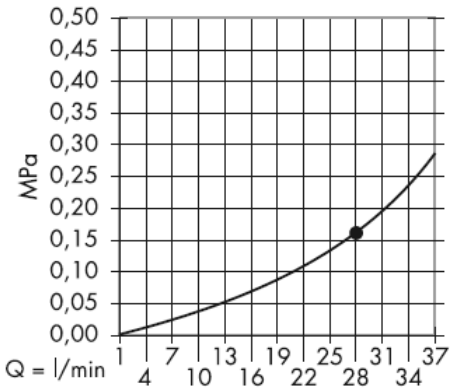

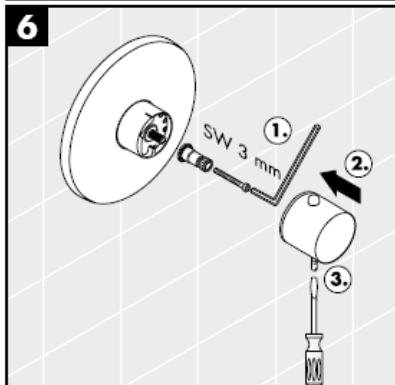
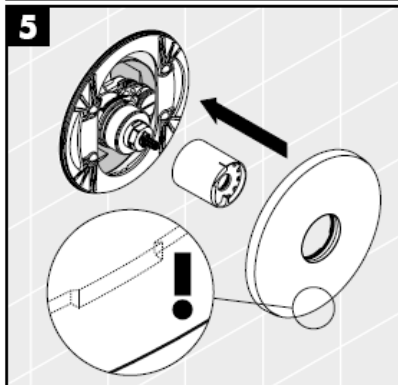
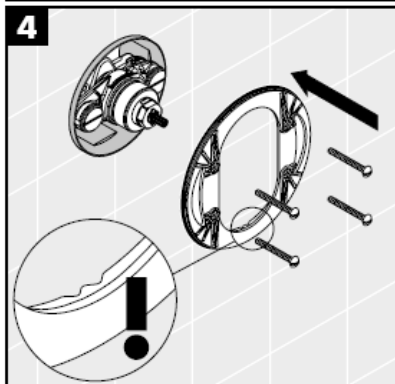
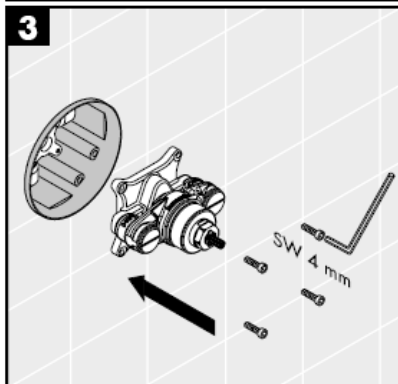
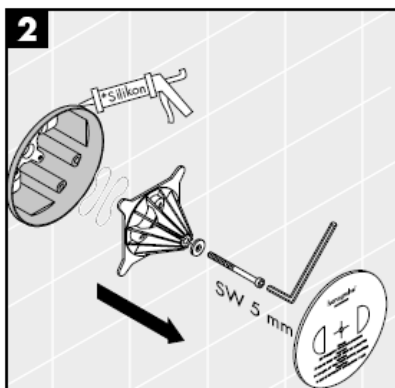
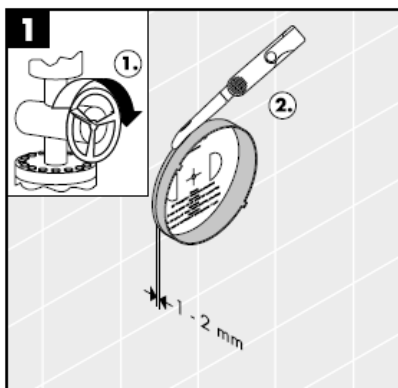

Silicone (azijnzuurvrij!)

Dankzij de Safety Function kan de gewenste maximale temperatuur van bijv. max. 42 °C van tevoren worden ingesteld.

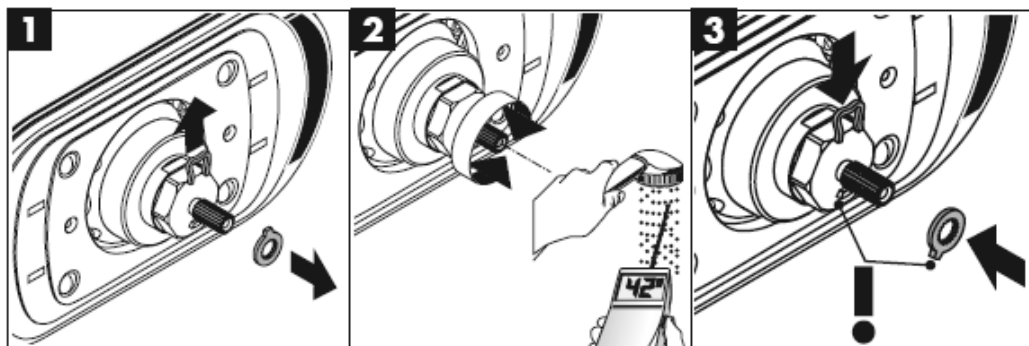

Correctie

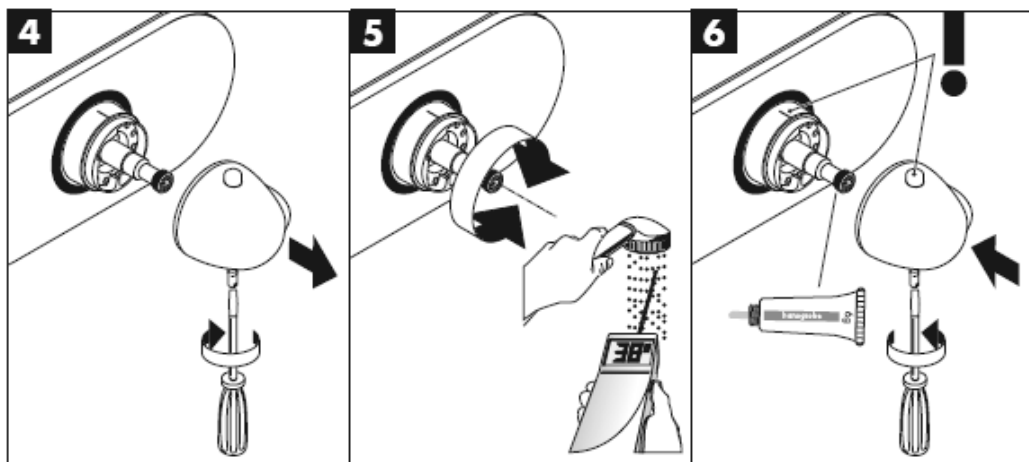



Als de douche in werking is, heeft hij samen met de douchearm een gewicht van ongeveer 10 kg. Daarom mag alleen bevestigingsmateriaal worden gebruikt dat geschikt is voor metselwerk! De bijgeleverde schroeven en pluggen zijn alleen geschikt voor massief m

Er mag alleen bij het wandmateriaal passend bevestigingsmateriaal gebruikt worden! De bijgeleverde schroeven en pluggen zijn alleen bestemd voor massief wandmateriaal.

De afvoercapaciteit moet voldoende gedimensioneerd worden.

Optimal funktionieren gegarandeert bei Kombination mit Hansgrohe High Flow Thermostaten.

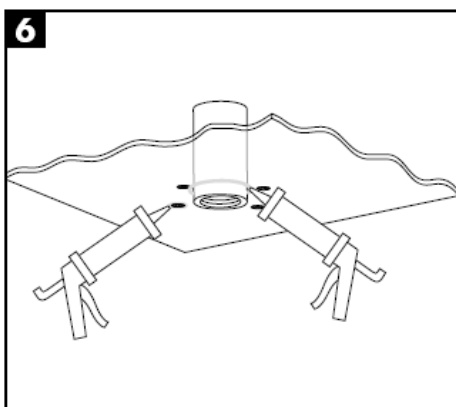
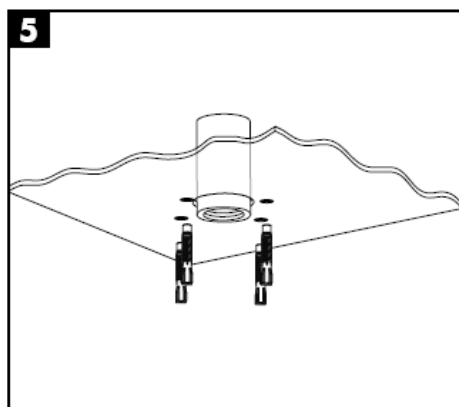
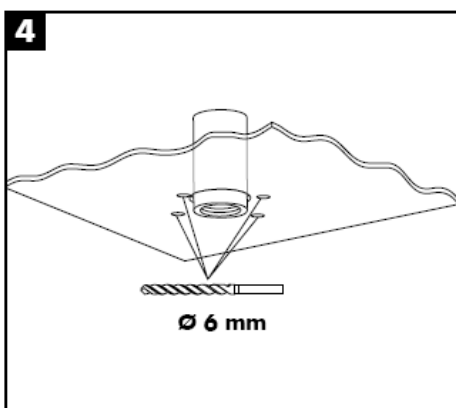
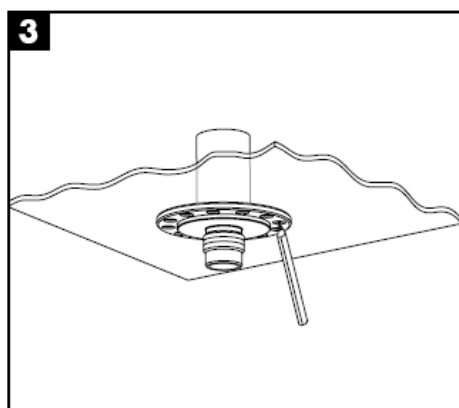
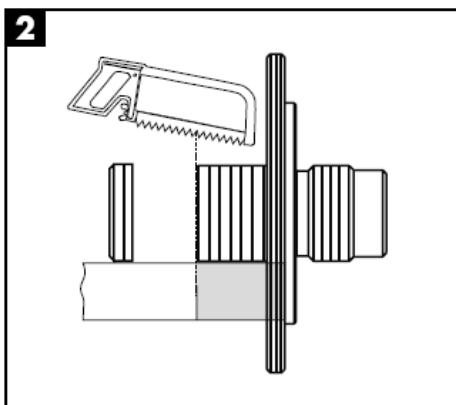
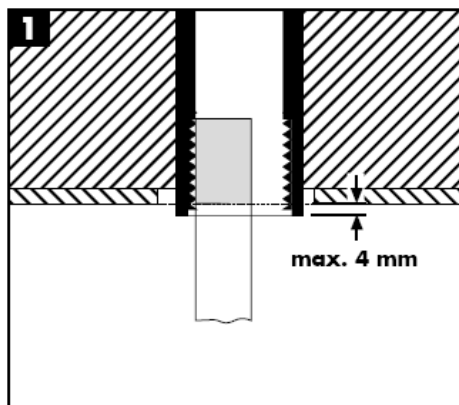

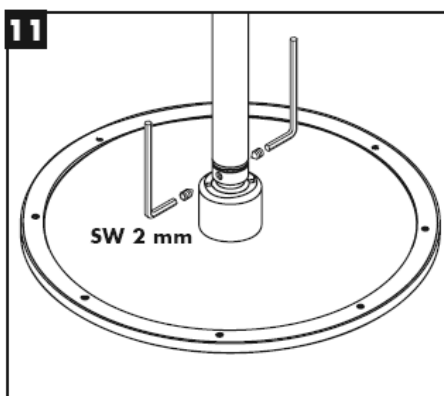
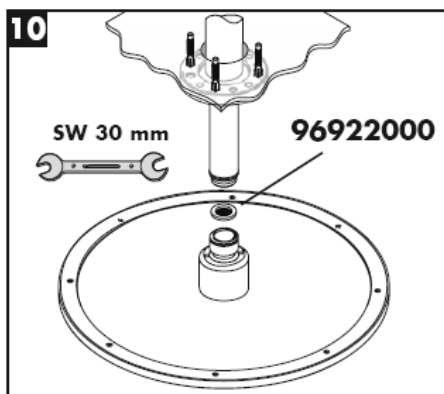
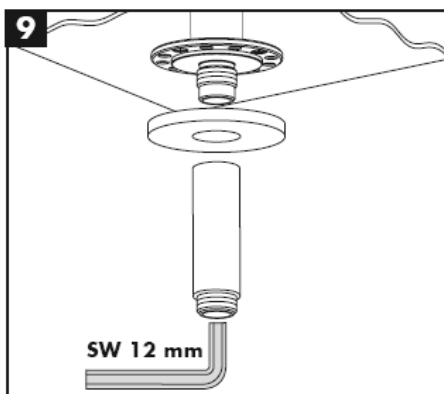
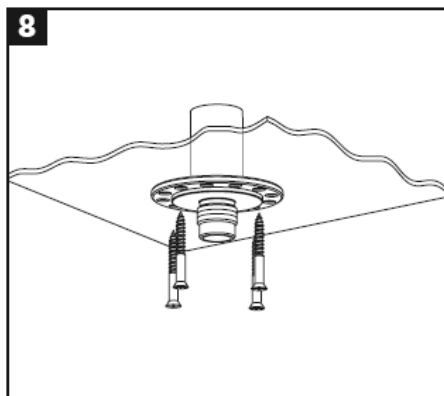
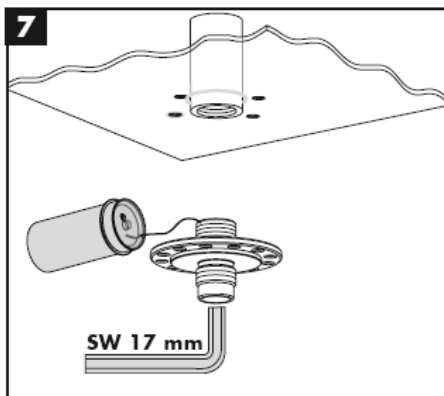

Het bij de hoofddouche verpakte zeefje moet worden ingebouwd om vuil uit de waterleiding te weren. Vuil uit de leidingen kan de werking van de hoofddouche negatief beïnvloeden en/of de hoofddouche beschadigen. Voor deze schade is Hansgrohe niet verantwoordelijk.

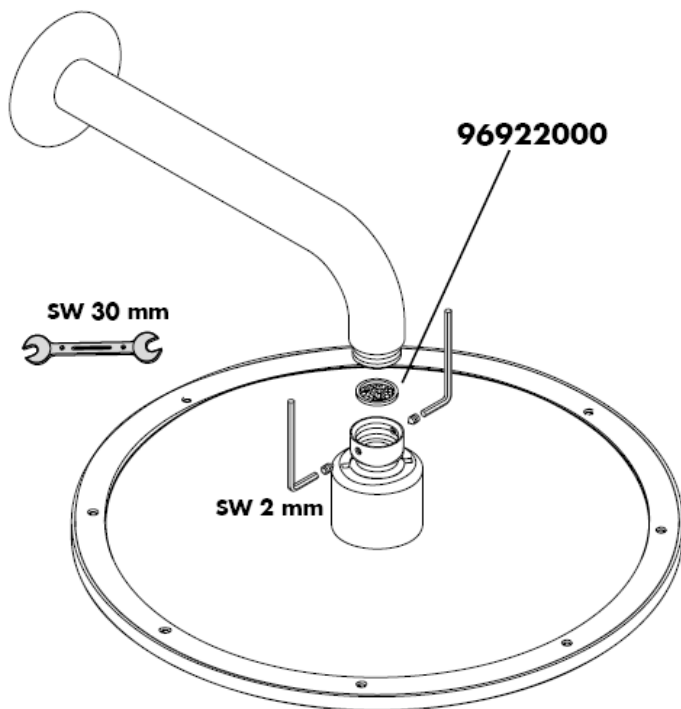

Montage

Attentie! Leidingen doorspoelen volgens Norm. De mengkraan vervolgens monteren en controleren!

Correctie

Een correctie is noodzakelijk als de temperatuur aan het aftappunt afwijkt van de ingestelde temperatuur. Daarbij dient het volgende in acht genomen te worden:

Greep draaien tot het water bij het aftappunt een temperatuur heeft van 38 °C. Greepschroef losdraaien, greep terugtrekken en tot stand 38 °C draaien. Greep terug plaatsen en greepschroef vastdraaien (zie blz 22).

Temperatuurbegrenzing

Het temperatuurgebied wordt door de veiligheidsblokkering tot 38 °C begrensd. Als er een hogere temperatuur gewenst wordt, kan de blokkering van 38 °C door het indrukken van de veiligheidsknop overschreden worden.

Safety Function

Dankzij de Safety Function kan de gewenste maximale temperatuur van bijv. max. 42 °C van te voren worden ingesteld. zie blz. 21.

Technische gegevens

Werkdruk: max. max. 1 MPa
Aanbevolen werkdruk: 0,1 – 0,5 MPa
Getest bij: 1,6 MPa
(1 MPa = 10 bar = 147 PSI)
Temperatuur warm water: max.80° C
Aanbevolen warm water temp.: 65° C
Doorstroomcapaciteit: ca.58 l/min 0,3 MPa

Onderhoud

Thermostaten behoeven geen speciaal onderhoud. Keerkleppen moeten volgens DIN EN 1717 regelmatig en volgens plaatselijk geldende eisen op het functioneren gecontroleerd worden. (Tenminste een keer per jaar). Tevens moeten de zeeffjes op het thermoelement worden gecontroleerd (6.1). Na montage van het MTC thermo-element moet de uitstroomtemperatuur gecontroleerd worden. Zie hiervoor 'correctie'. Controleer vooraf of de warmwater voorziening functioneert en wat de maximale watertemperatuur bij het tappunt is.

Om het soepel lopen van de regeleenheid te garanderen moet de thermostaat van tijd tot tijd op heel koud en heel warm worden ingesteld.

Service onderdelen zie blz. 3

1	thermostaatgreep	38391000
2	rozet	96452000
3	huls	97439000
4	Drager-schroef	96454000
5	rozetdrager	96447000
6	temperatuur regeleenheid	96633000
7	zeeffje	97367000
8	terugslagklep	96655000
9	Verlengstuk 25 mm	13595000
10	Verlengstuk 25 mm	13596000

Nederlands

Storing	Oorzaak	Oplossing
Weinig water	-Druk te laag -Vuilzeef van thermo-element verstopt -Zeefdichting handdouche verstopt	-Druk controleren -Vuilzeef reinigen -Zeefdichting handdouche reinigen
Kruisstroom, warm water stroomt in gesloten toestand in koud water leiding of omgekeerd	-Terugslagkleppen vervuild of defect	-Terugslagklep uitwisselen
Uitstroomtemperatuur komt niet met ingestelde temperatuur overeen	-Thermostaat niet ingesteld -Temperatuur van warm water te laag	-Thermostaat instellen -Warmwater toevoer verhogen min. 42 C naar 65 C
Temperatuur niet regelbaar	-Thermo-element vervuild of verkalkt -Functieblok 180 draaien	-Bij nieuwe installaties: basisgarnituur verkeerd aangesloten (moet zijn koud rechts en warm links) of 180 gedraaid gemonteerd -Safety Stop knop op thermostaatgreep functioneert niet
Veer defect	-Veer en/of drukknop reinigen dan wel uitwisselen -Drukknop verkalkt	-Veer en/of drukknop reinigen dan wel uitwisselen -Veer en/of drukknop reinigen dan wel uitwisselen

Keurmerk

	P-IX	DVGW	SVGW	WRSA	KIWA	ACS	NF
27070000						X	
27418XXX							
28420000						X	
28435XXX						X	

Reinigen

Eenvoudig schoon: Kalk kan eenvoudig van de noppen worden gewreven.

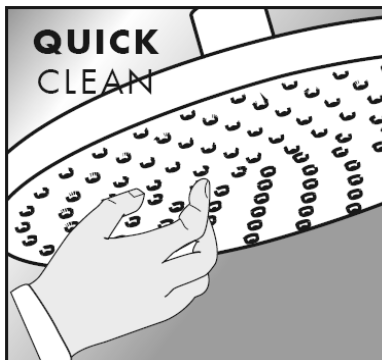

Reinigingsaanwijzingen

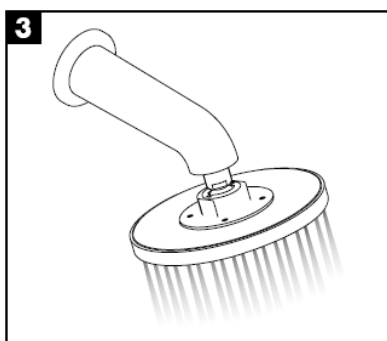
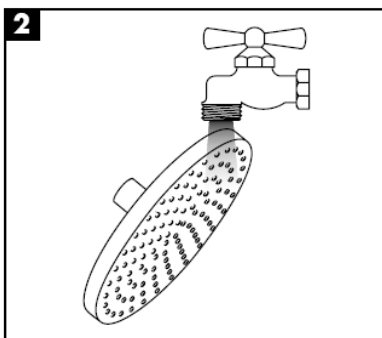
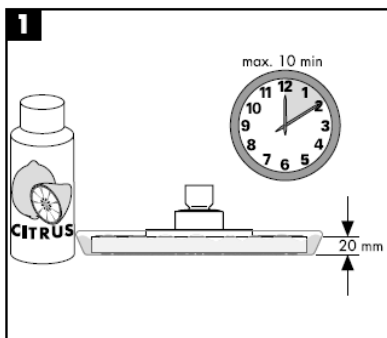

hansgrohe

Monteringsvejledning



27418XXX

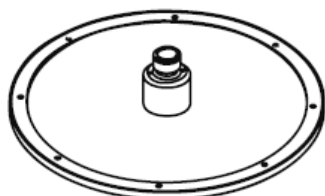

Raindance Royale AIR
28420000

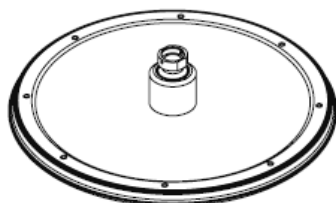

Raindance Royale Classic AIR
28435XXX

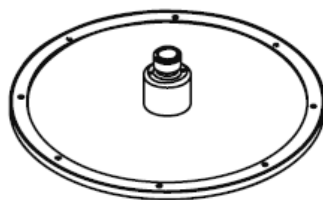

**Raindance Royale
High Flow Set**
27070000

hansgrohe

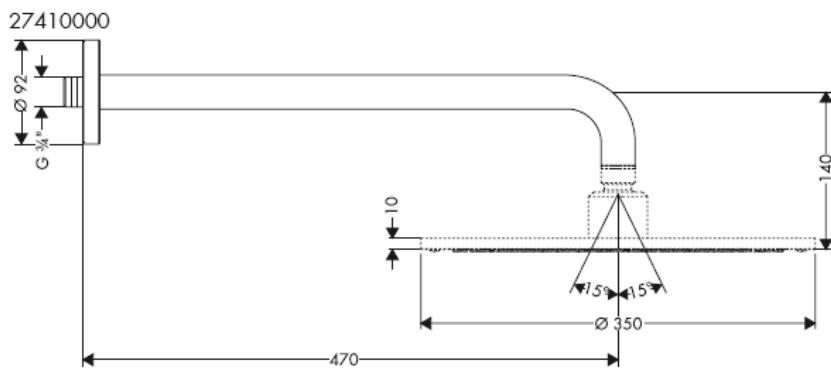
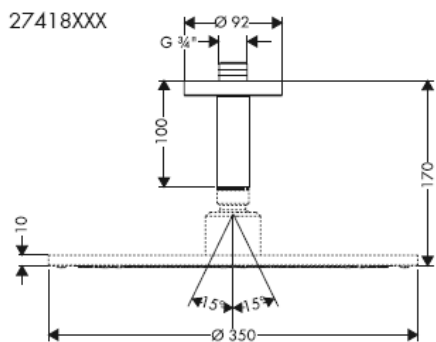
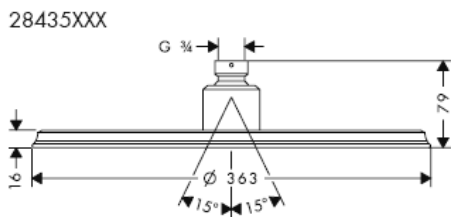
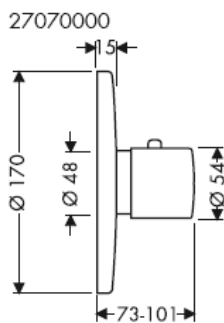
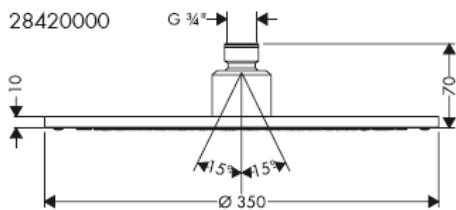

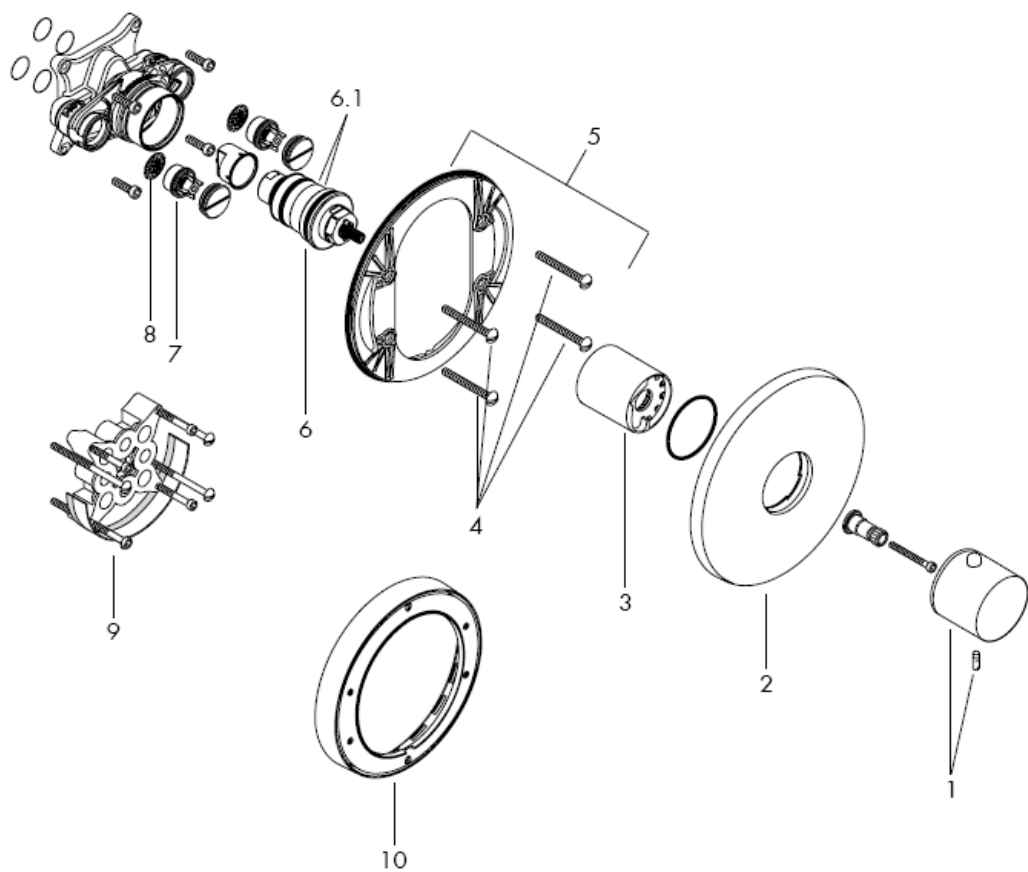

Afpass om muligt målene med fugerne.

Område nødvendigvægforstærkning

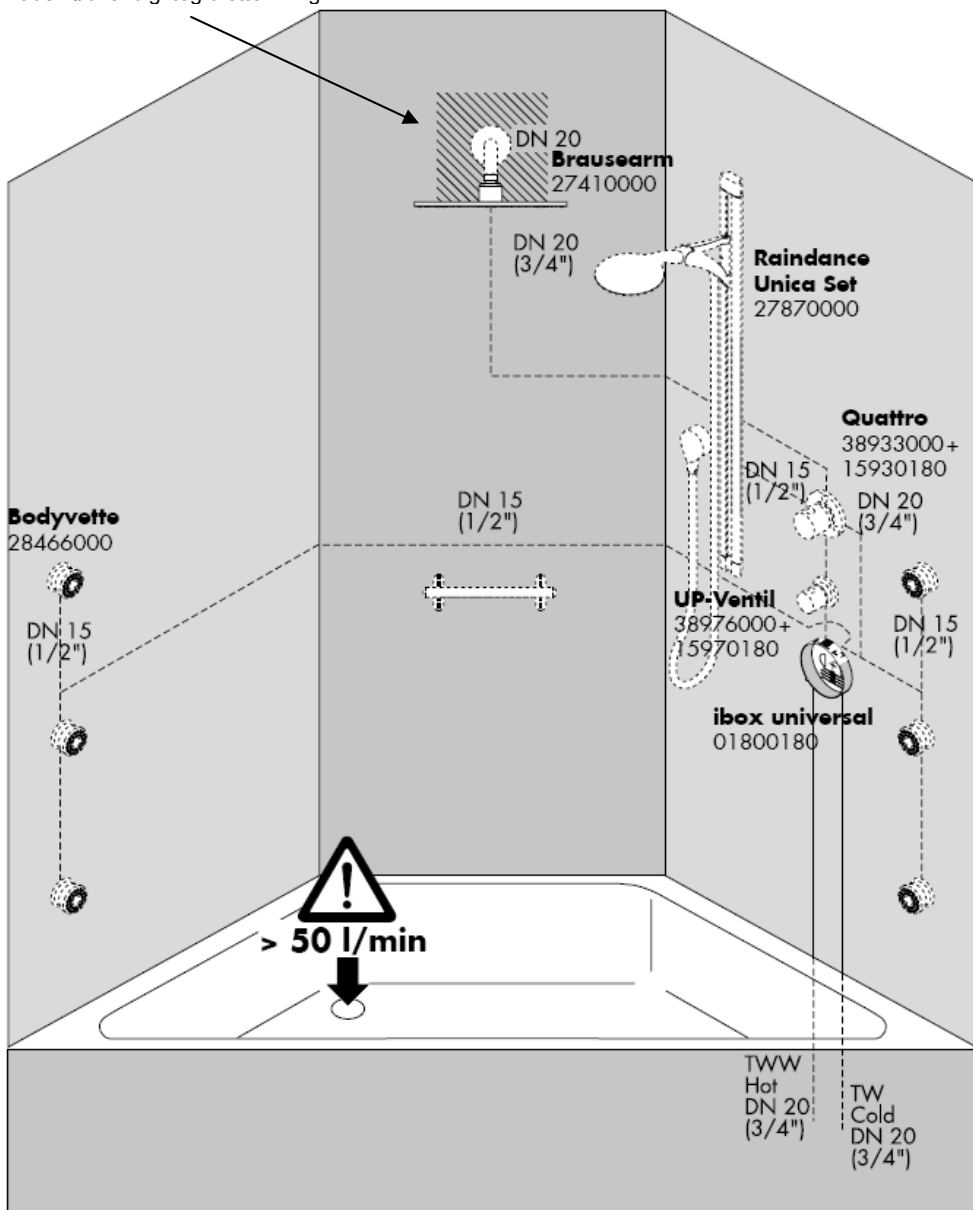

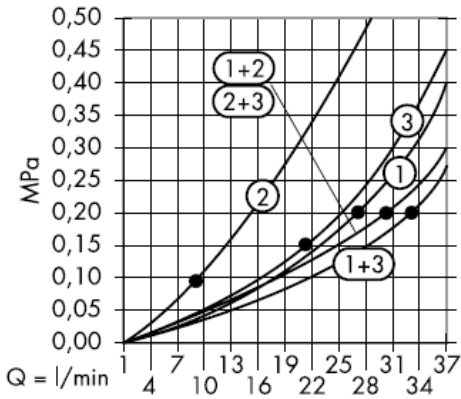

Fra • er funktionen anvendelig.

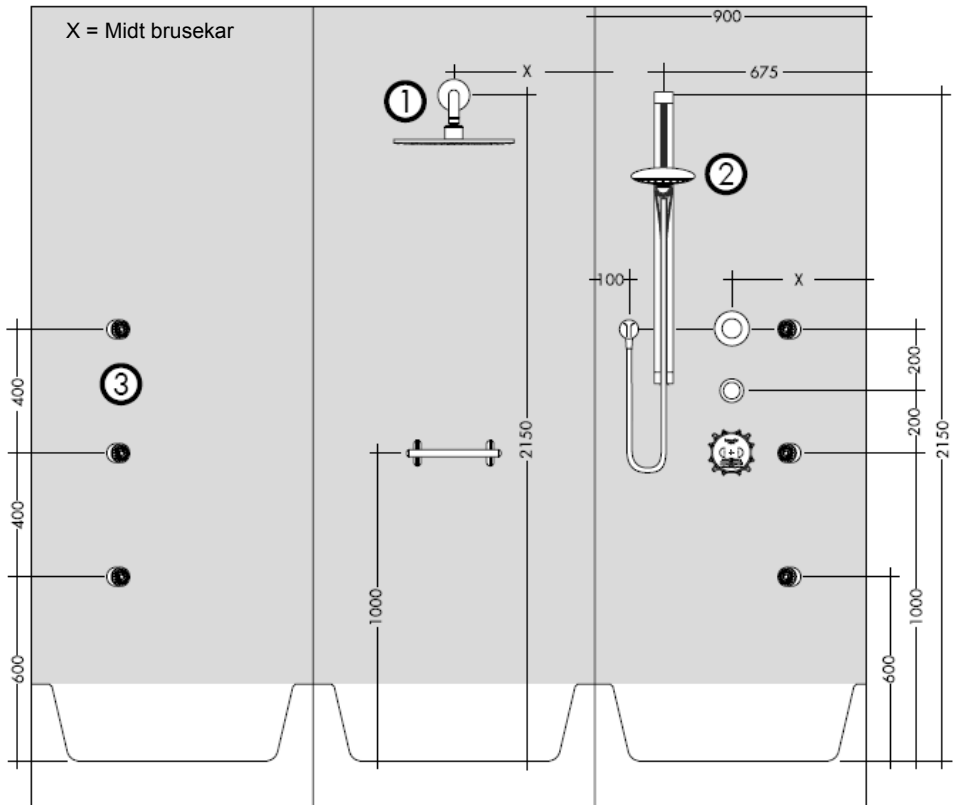

Område nødvendigvægforstærkning

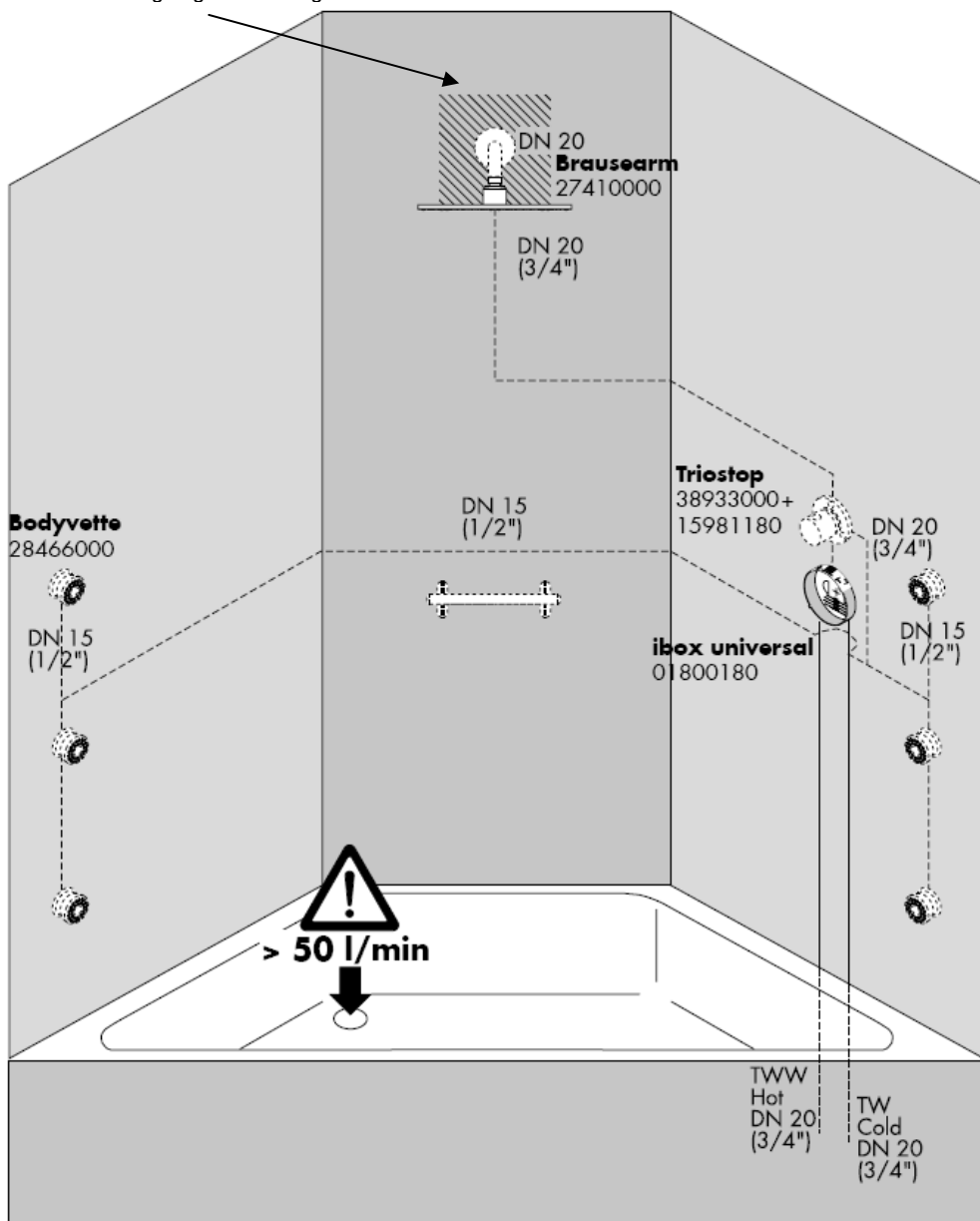

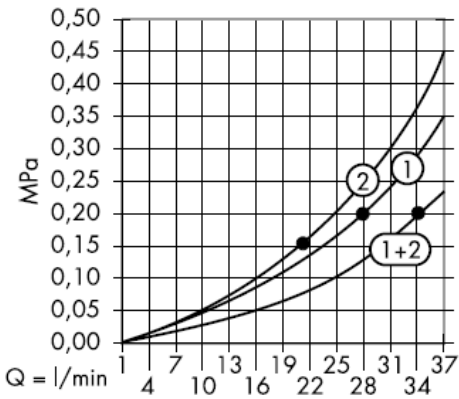

Fra • er funktionen anvendelig.

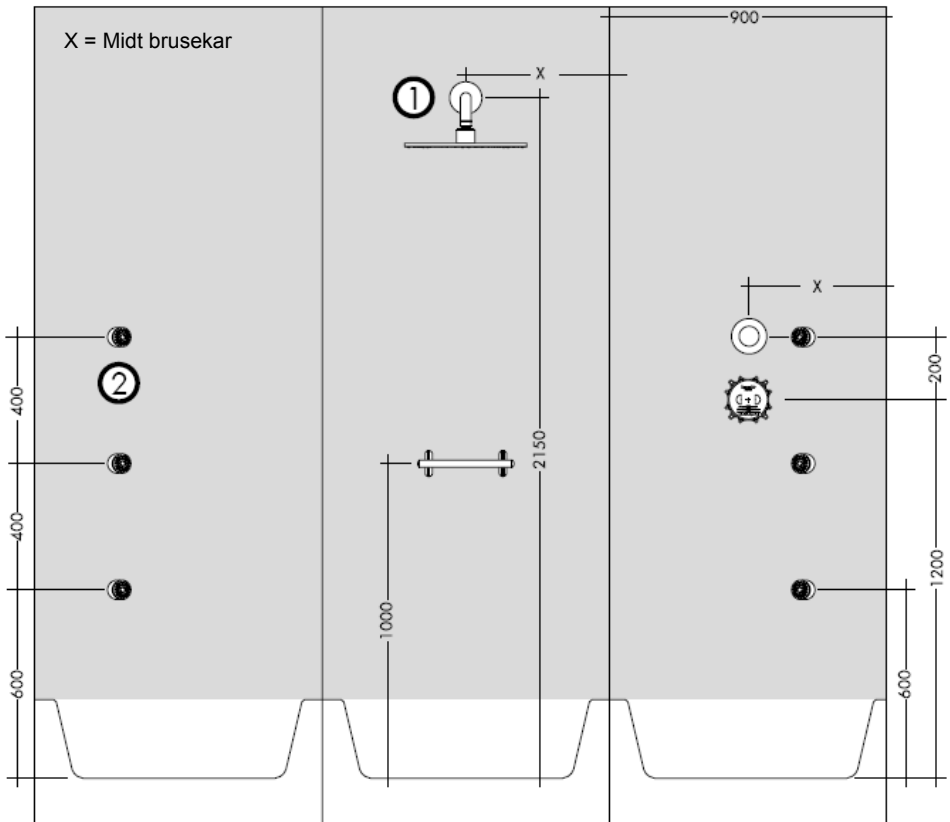

Område nødvendigvægforstærkning

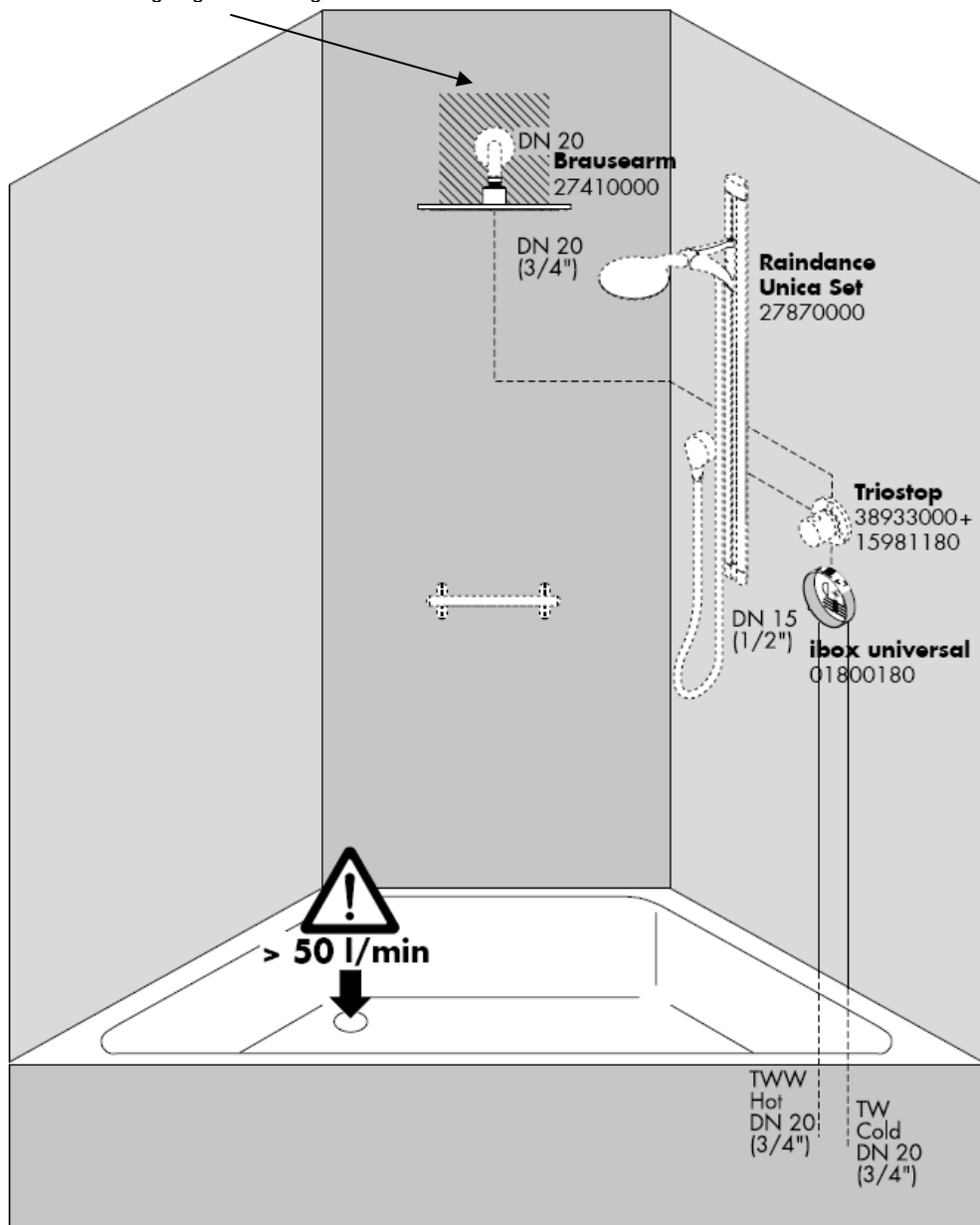

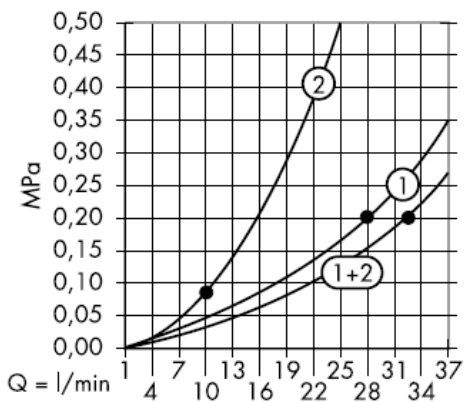

Fra • er funktionen anvendelig.

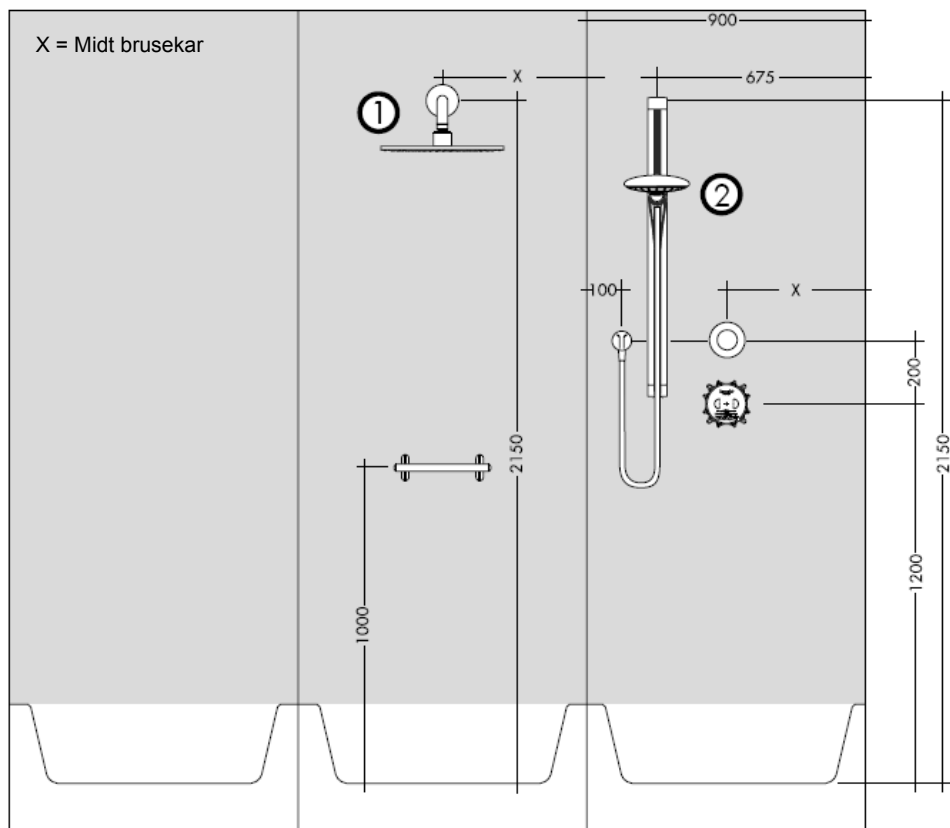

Område nødvendigvægforstærkning

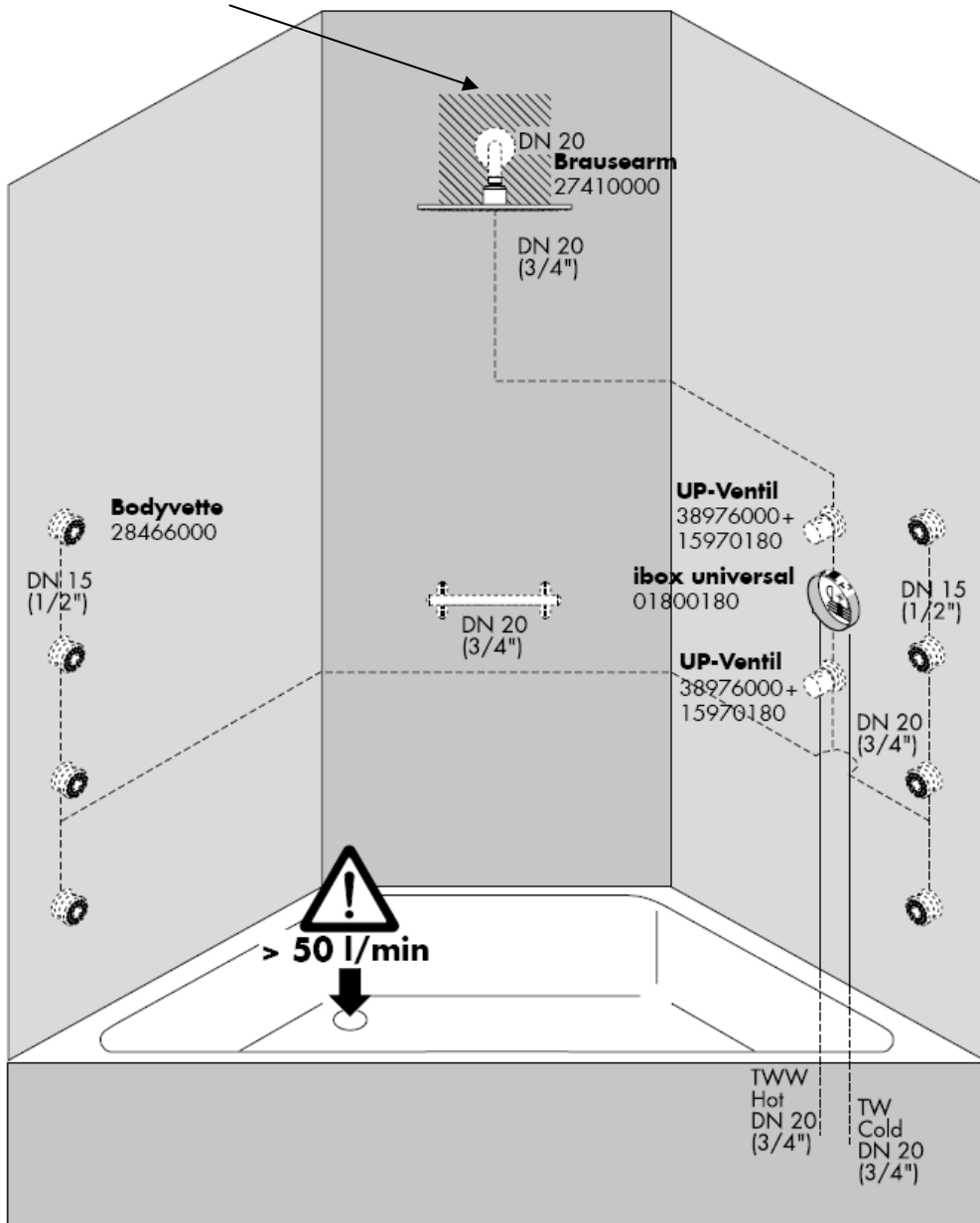

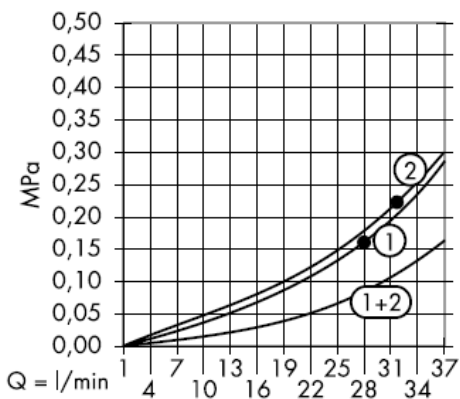

Fra • er funktionen anvendelig.

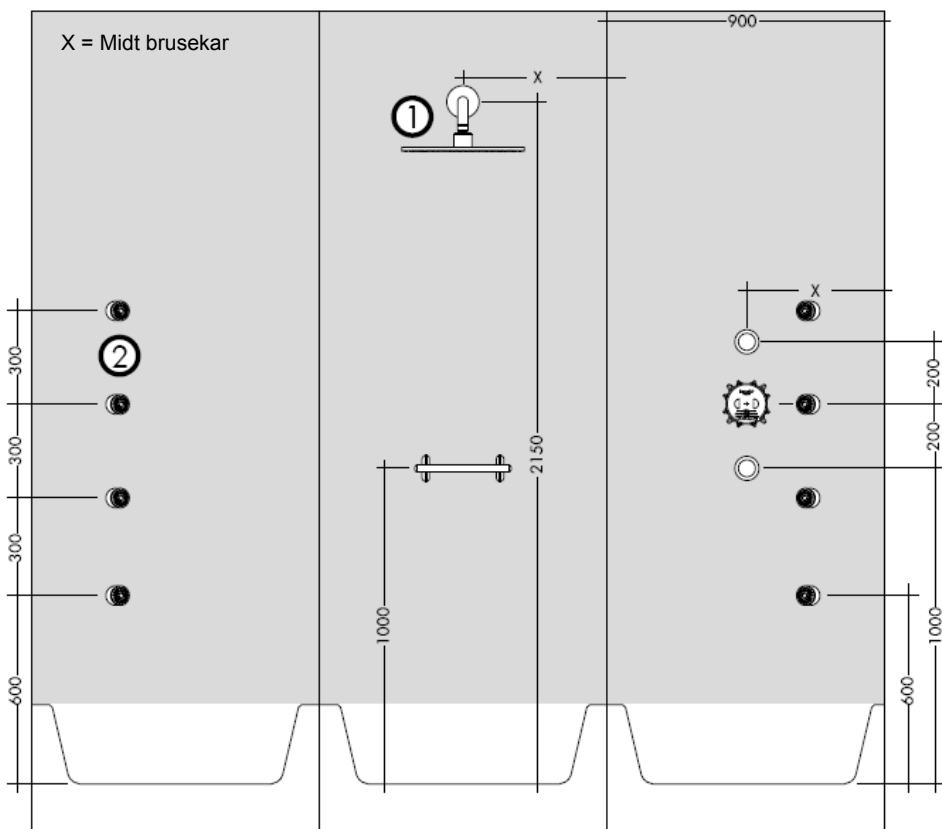

Område nødvendigvægforstærkning

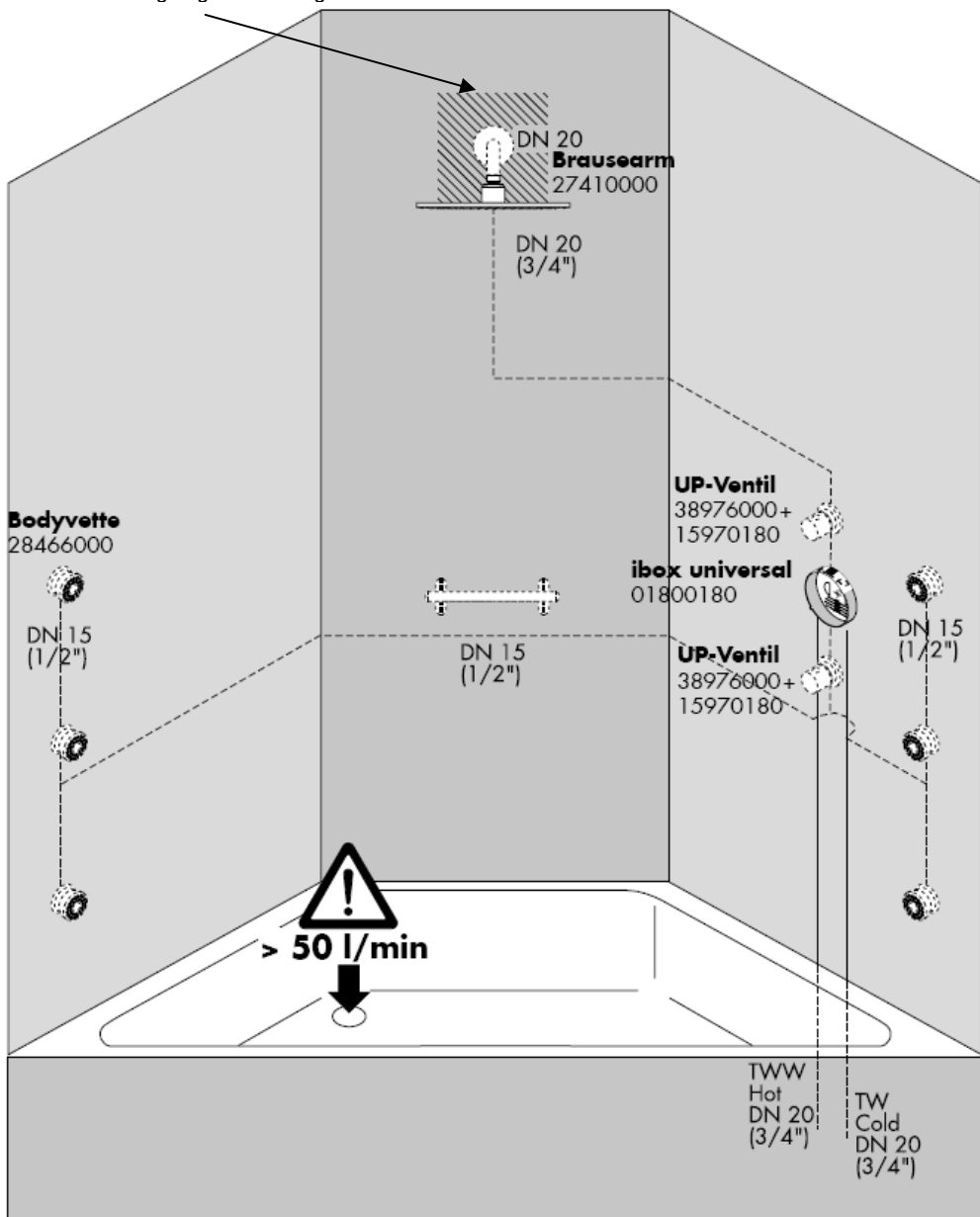

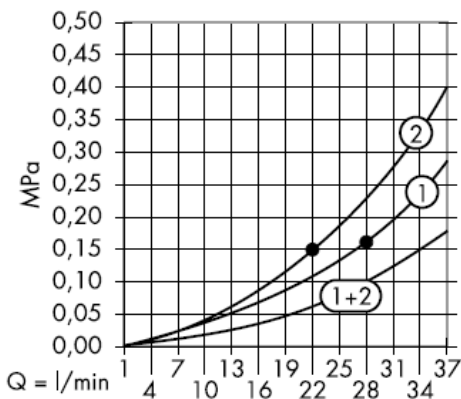

Fra • er funktionen anvendelig.

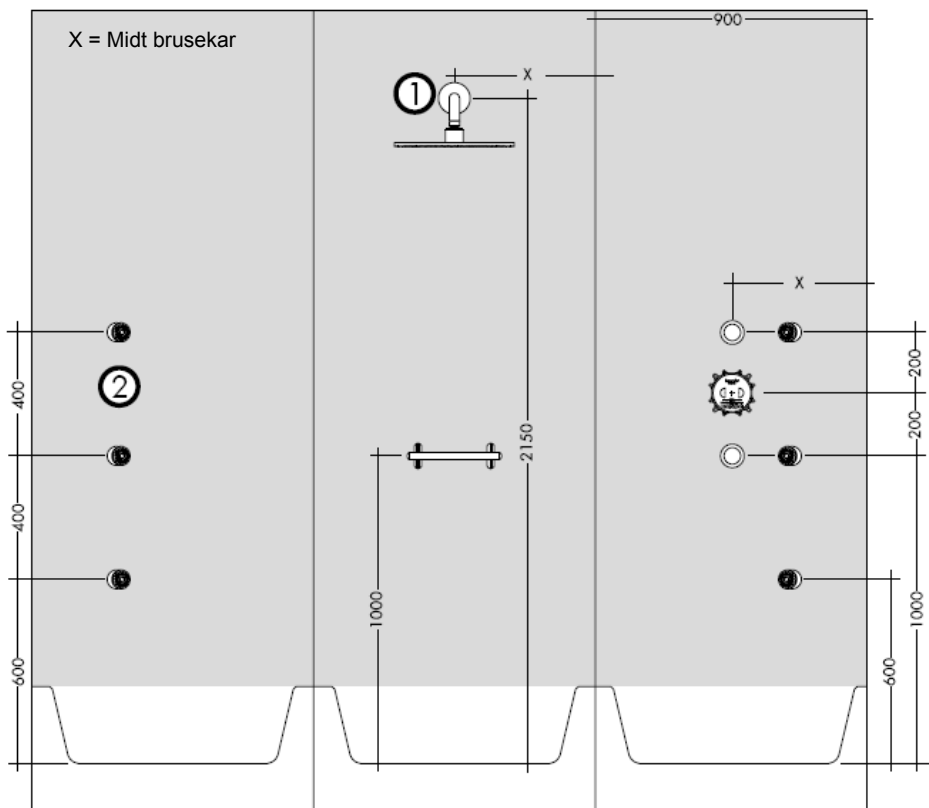

Område nødvendigvægforstærkning

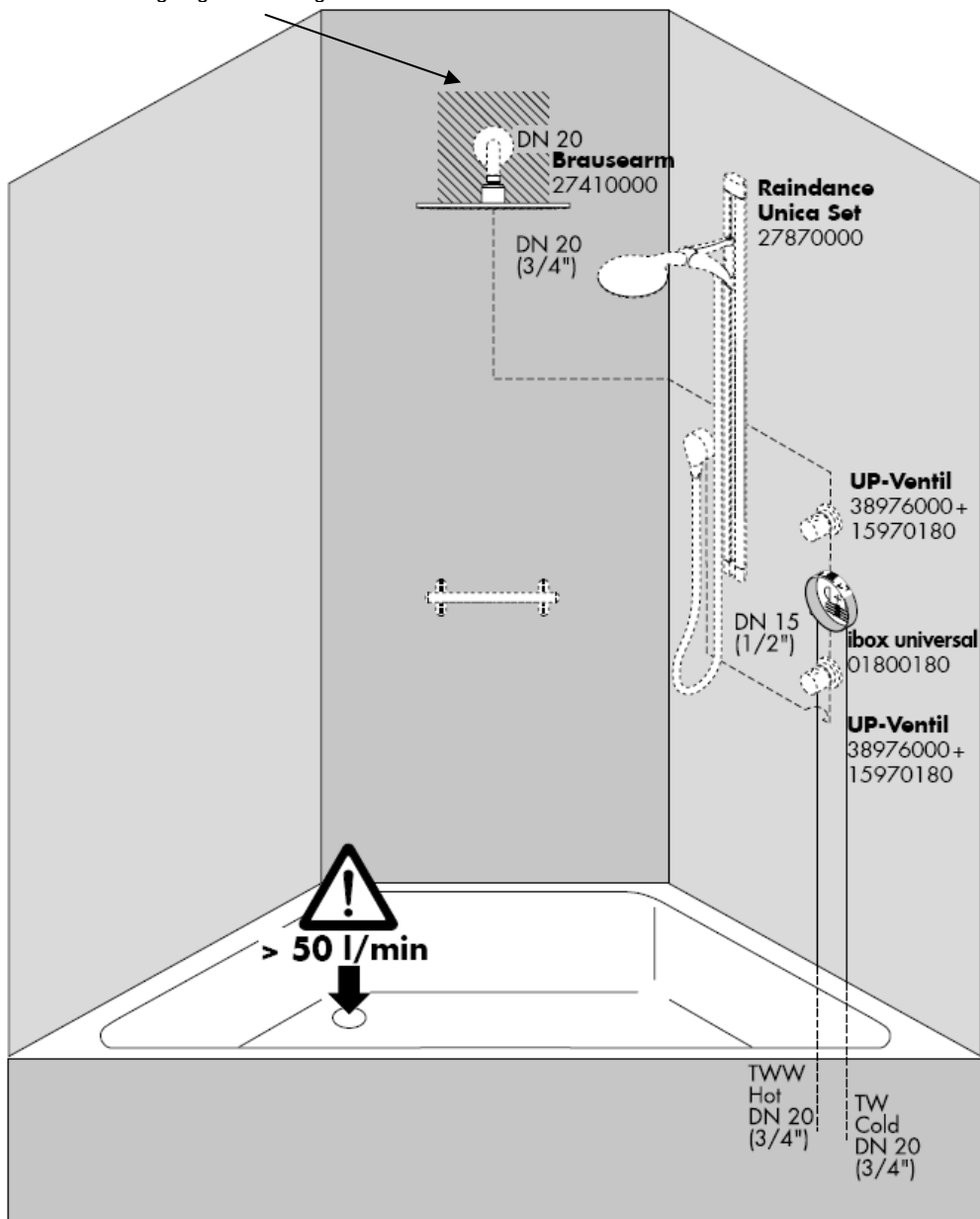

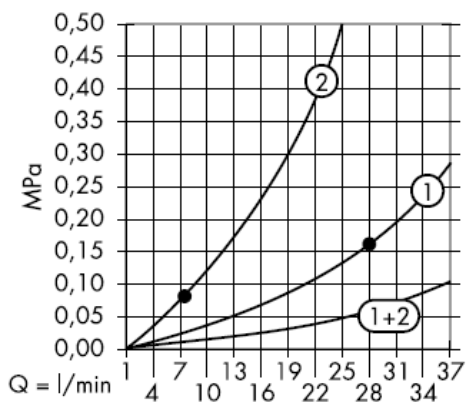

Fra • er funktionen anvendelig.

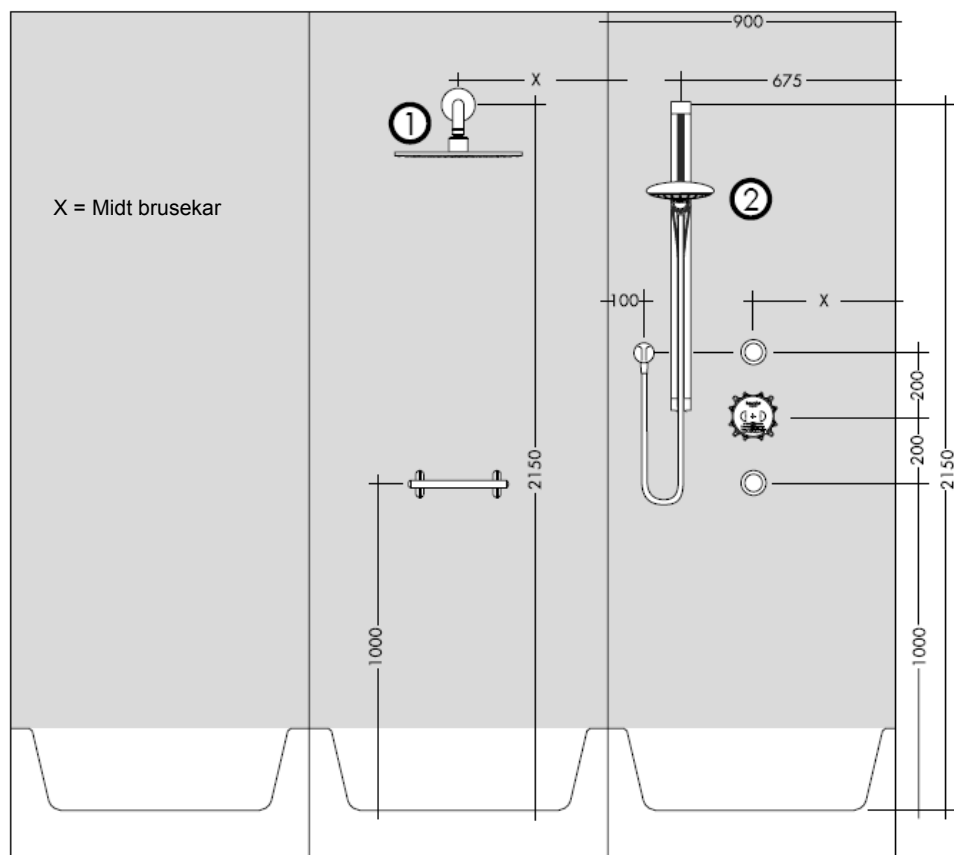

Område nødvendigvægforstærkning

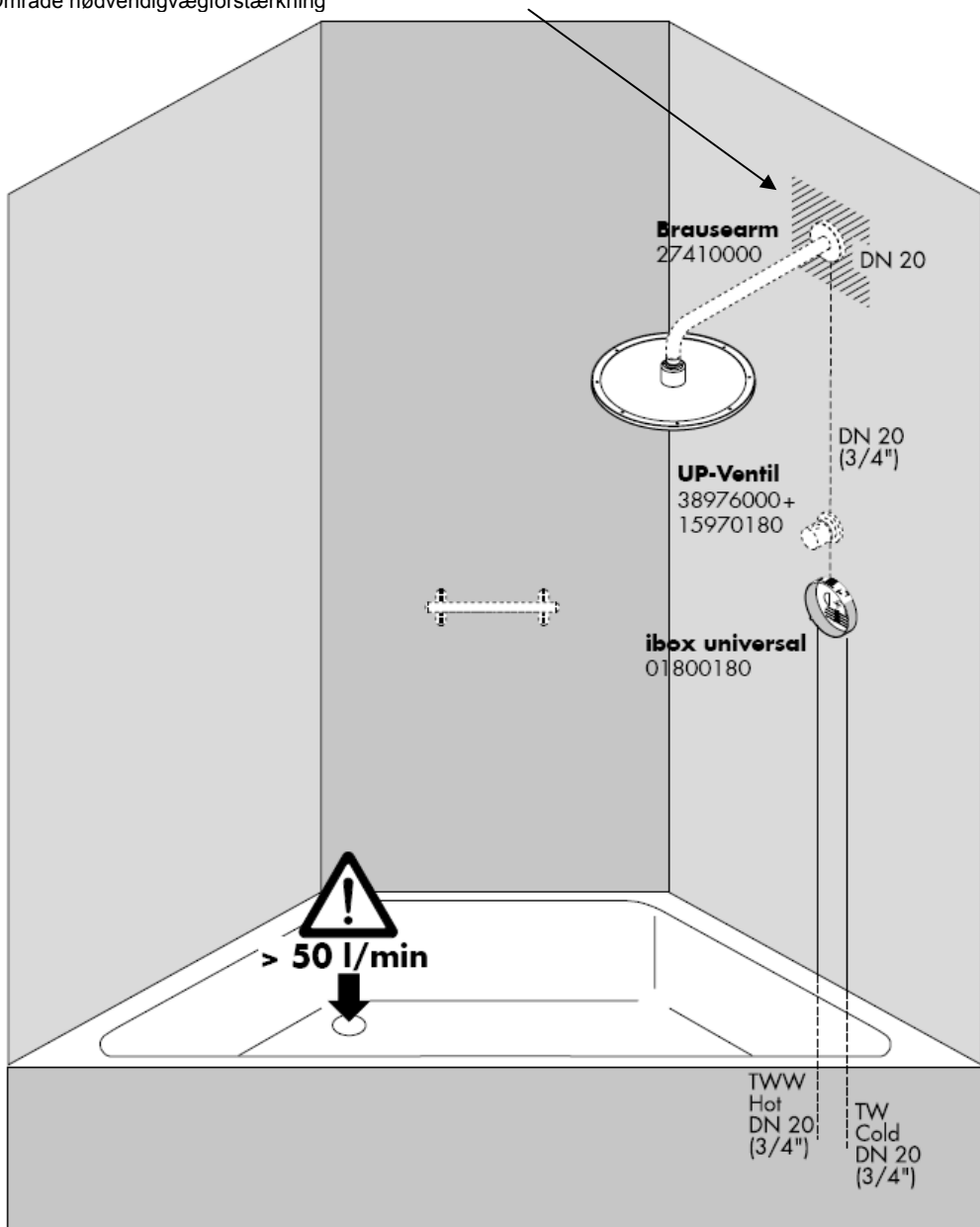

Fra • er funktionen anvendelig.

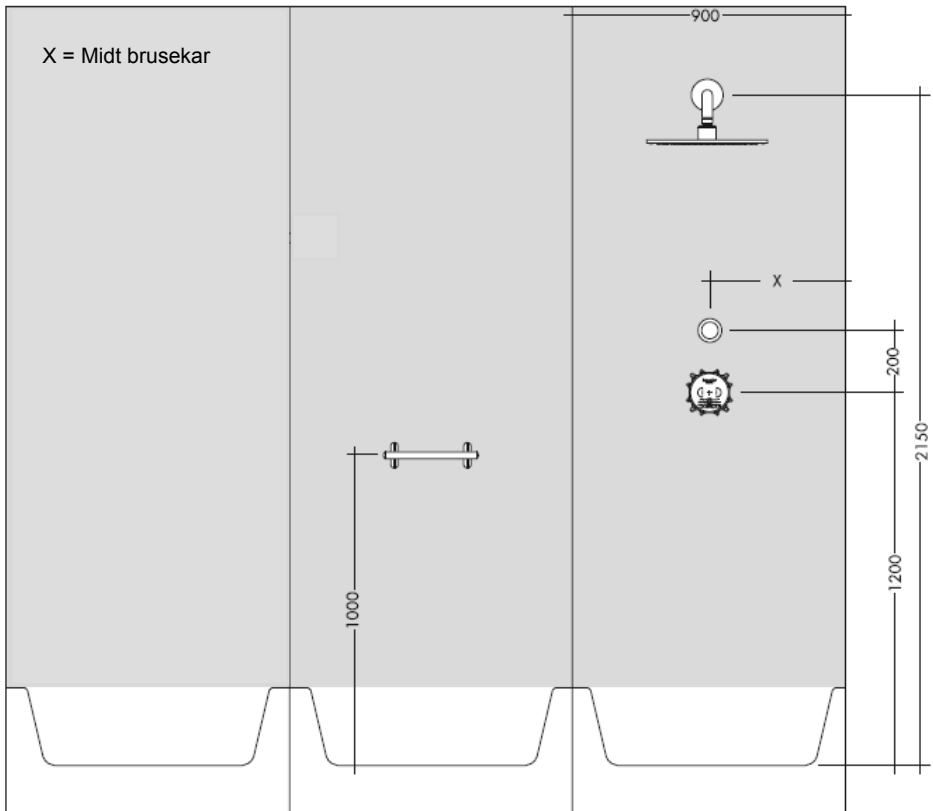
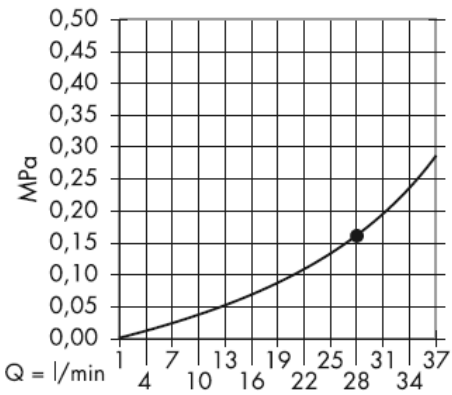

Område nødvendigvægforstærkning

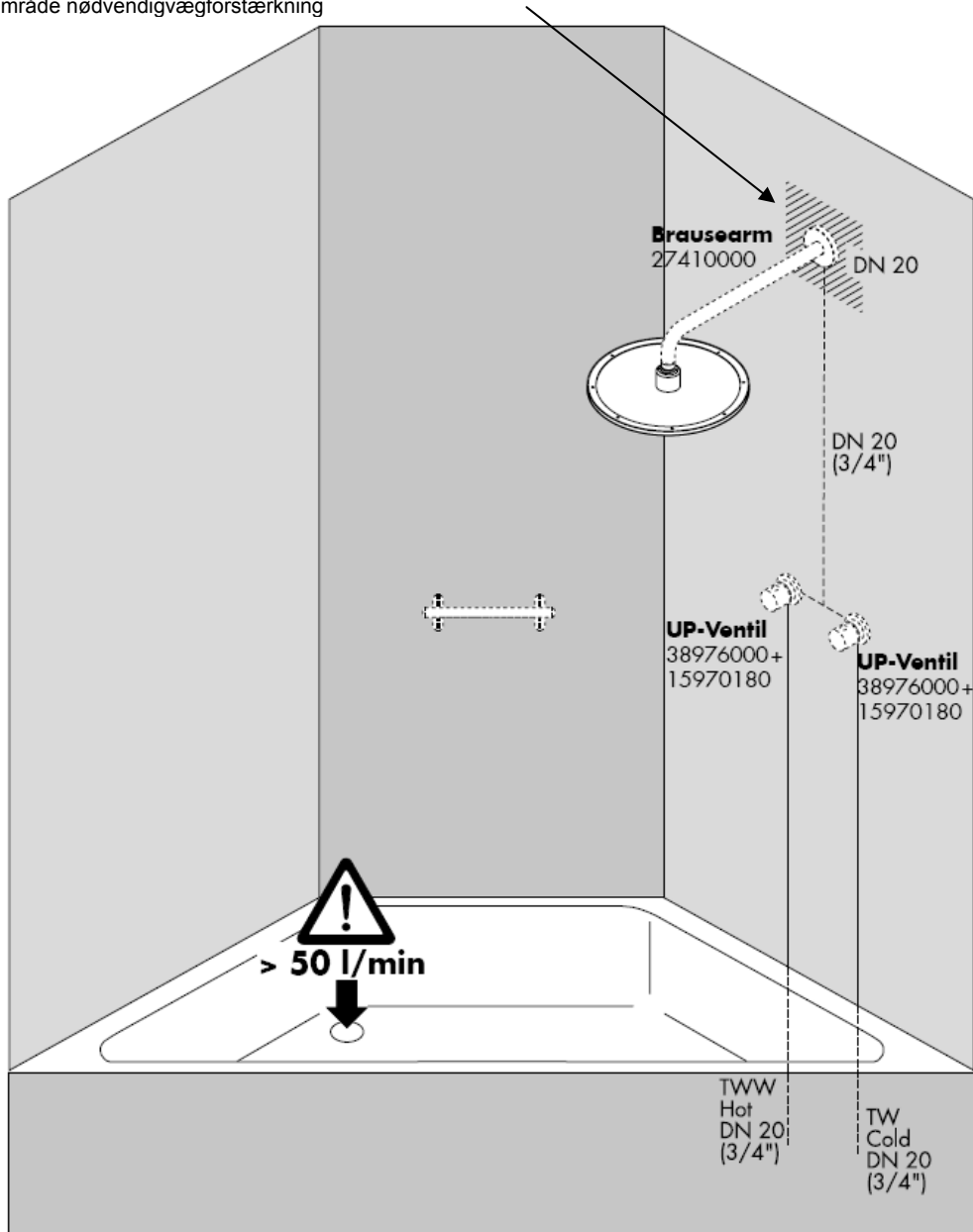

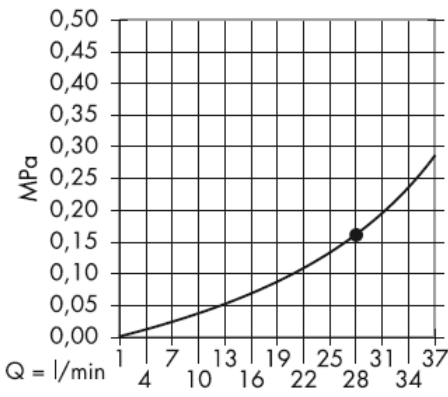

Fra • er funktionen anvendelig.

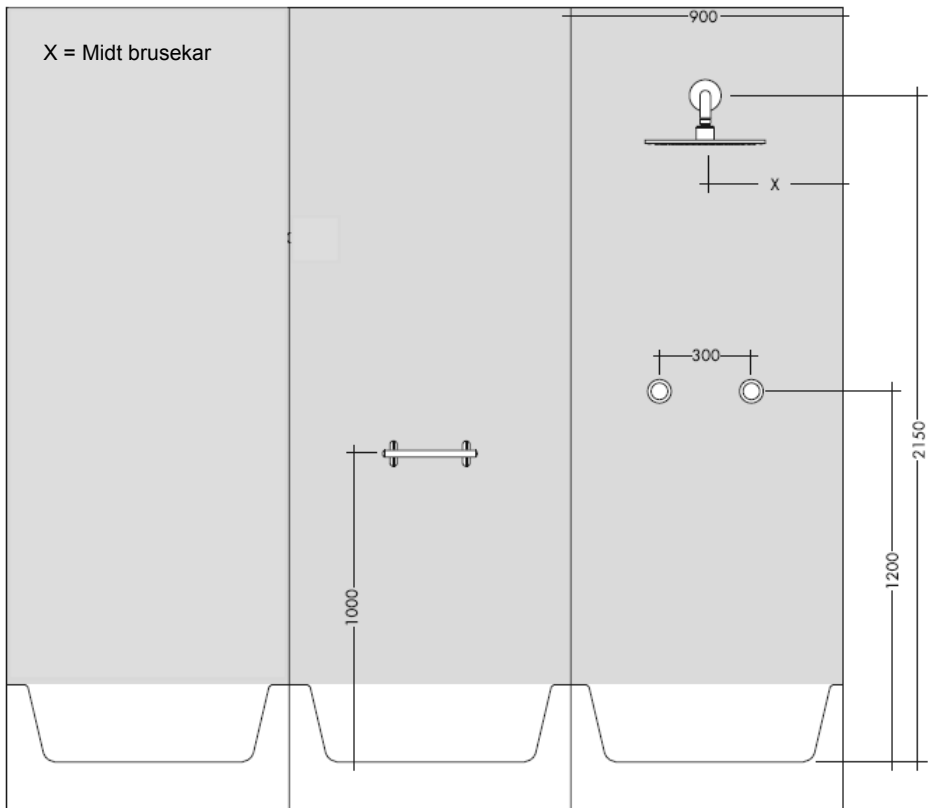

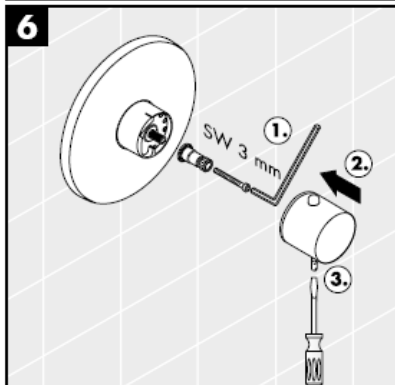
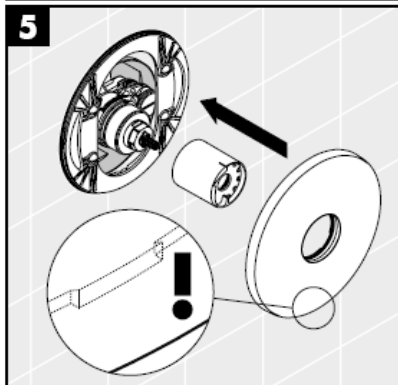
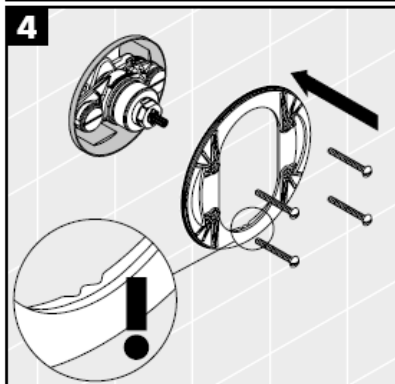
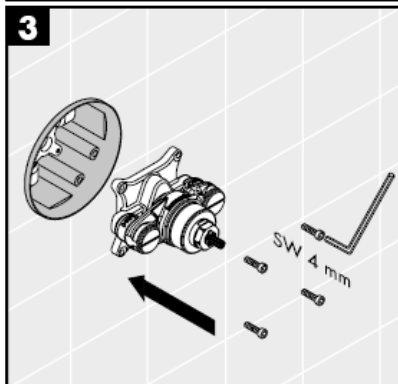
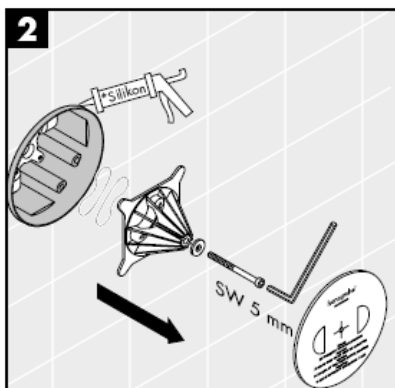
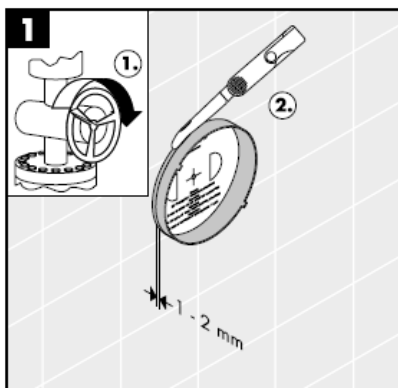

Silikone (eddikesyre-fri)

Takket være Safety varmtvands-begrænsningen kan maksimaltemperaturen forudindstilles eksempel max. 42 C.

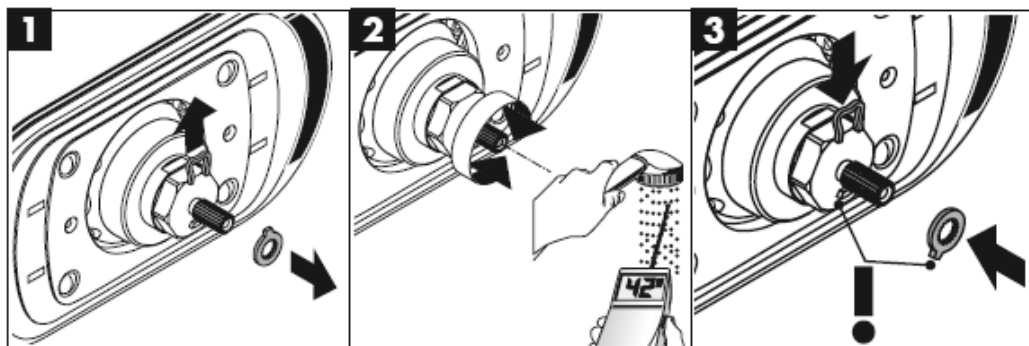

Justering

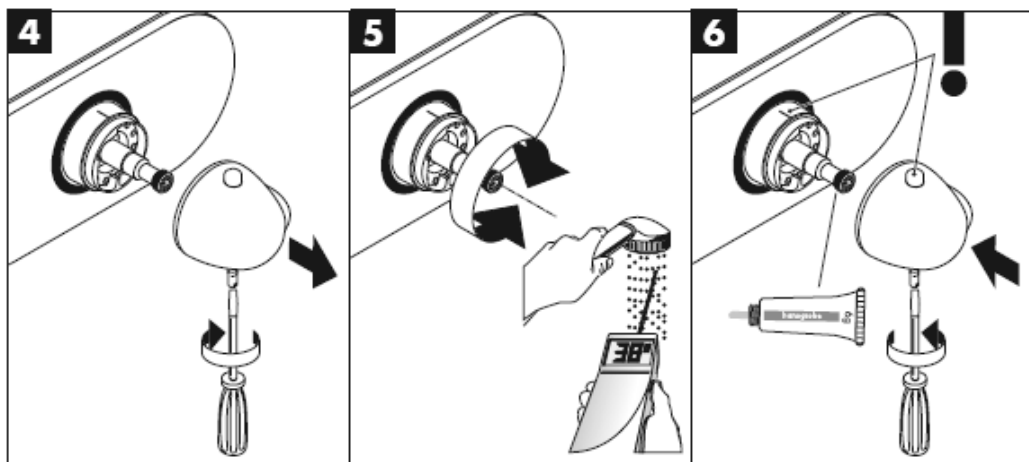



Hvis bruseren er i brug er vægten sammen med bruserarmen ca. 10 kg. Derfor må der kun anvendes befæstelsesmateriale som er velegnet til murværk! De vedlagte bolte og dyvler er kun beregnet til massivt murværk.

Benyt kun fastgørelsesmateriale, der er egnet til murværk! De vedlagte skruer og dyvler er kun beregnet til massivt murværk.

Afløbet skal være i en tilstrækkelig størrelse.

Optimal funktion garanteres for anvendelse i forbindelse med Hansgrohe High Flow Termostaten.

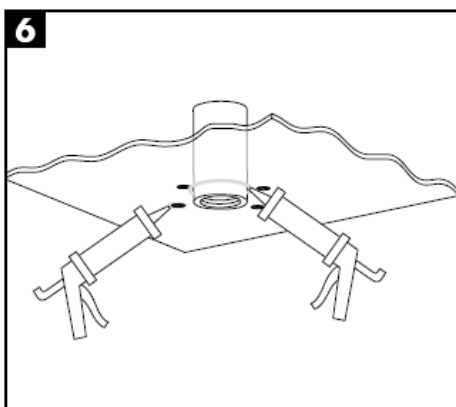
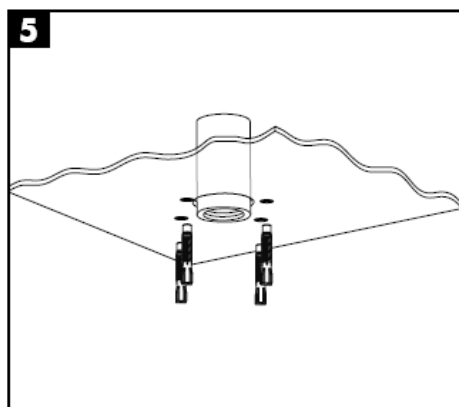
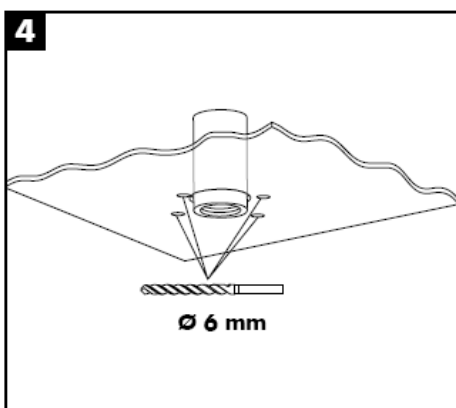
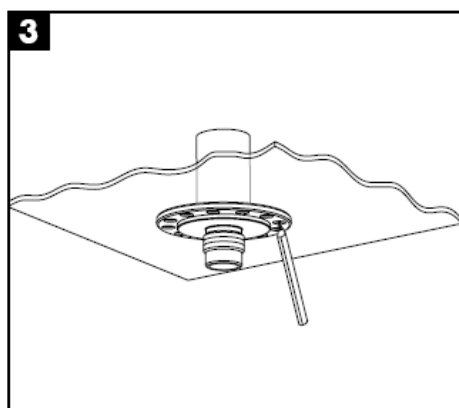
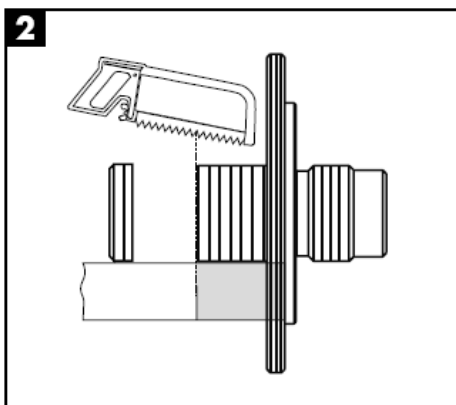
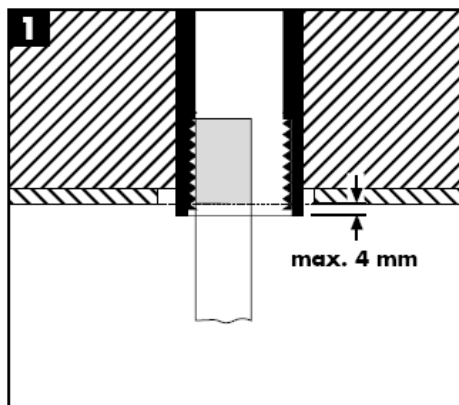

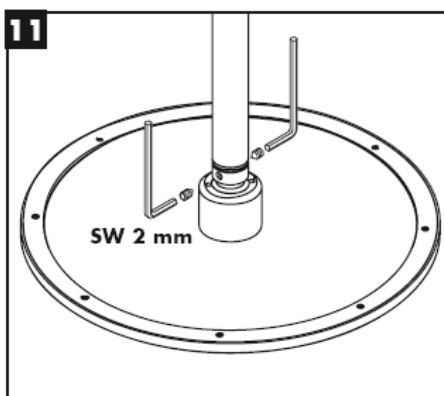
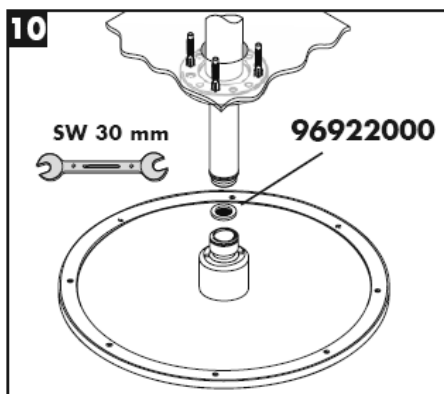
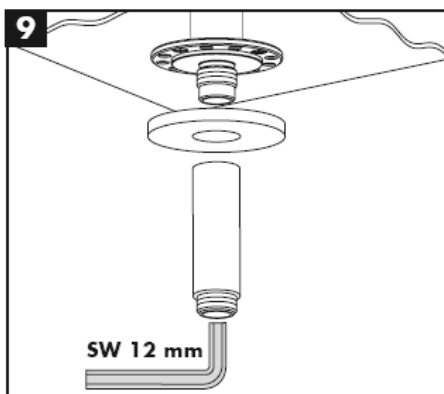
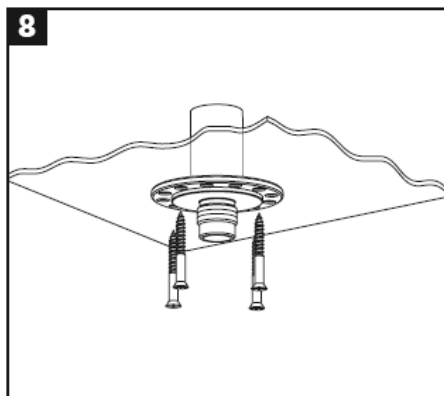
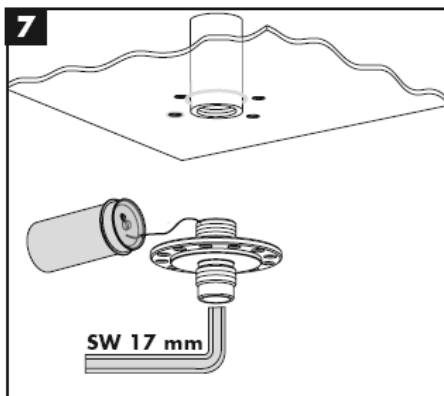

Den vedlagte smudsfangssi skal indsættes i bruseren for at undgå snavs fra rørsystemet. Indskyllet snavs kan have indflydelse på bruserens funktion og/eller føre til beskadigelser på håndbruserens funktionsdele.

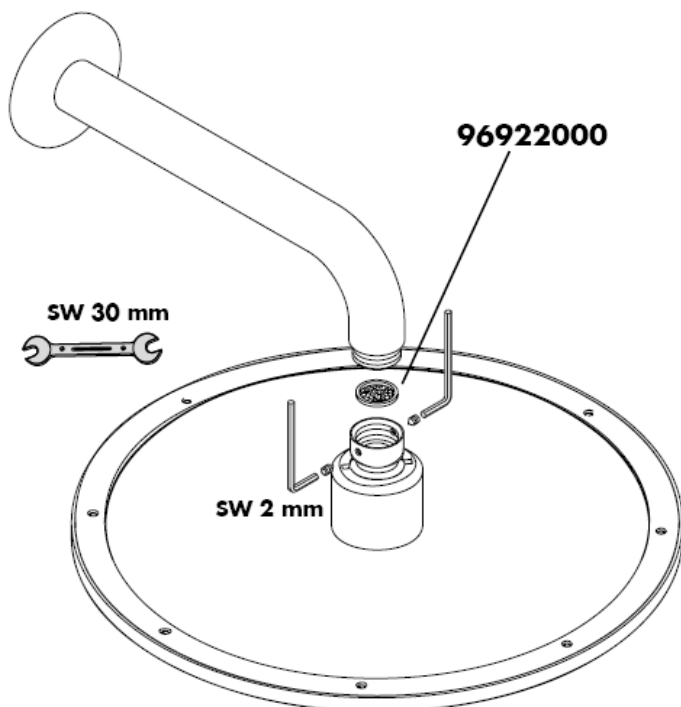

Montering

Advarsel! Leidingen doorspoelen volgens Norm. De mengkraan vervolgens montereren en controleren!

Justering

En justering er nødvendig, hvis udløbstemperaturen og den angivne temperatur ikke stemmer overens. Justering sker på følgende måde: Skalagrebet drejes så vandet er 38 °C. Skruen i grebet løsnes, grebet trækkes tilbage og drejes til stilling 38 °C. Grebet sættes på og skrues fast (se side 22).

Temperaturbegrænsning

Temperaturområdet er begrænset opad til 38 °C ved hjælp af sikkerhedsspærren. Ønskes en højere temperatur, kan denne spærre overskrides ved at trykke den sikkerhedsknap ind.

Safety Function

Takket være Safety varmtvands-begrænsningen kan maksimaltemperaturen forudindstilles eksempel max. 42 °C. se s. 21.

Tekniske data

Driftstryk: max. 1 MPa
 Anbefalet driftstryk: 0,1 – 0,5 MPa
 Prøvetryk: 1,6 MPa
 (1 MPa = 10 bar = 147 PSI)
 Varmtvandstemperatur: max. 80 °C
 Anbefalet varmtvandstemperatur: 65 °C
 Gennemstrømningskapacitet: ca. 58 l/min 0,3 MPa

Service

Termostaten behøver ikke nogen speciel service. Ifølge DIN EN 1717 skal gennemstrømningsbegrænsere i overensstemmelse med nationale regler afprøves regelmæssigt (mindst en gang om året). lejlighed bør smudsfangsien efterses – den befinder sig på termostatelementet (6.1). Efter montering af termostatelementet (6) er det vigtigt, at udløbstemperaturen kontrolleres (se under punktet "Justering"). Kontrolér at varmtvandsforsyningen er tilsluttet, og at temperaturen ikke overstiger max. temperatur. OBS! Det er vigtigt at motionere termostaten jævnligt ved at dreje termostatgrebet skiftevis på kold og varm.

For at sikre optimal funktion af termostaten, bør termostaten fra tid til anden motioneres (stilles skiftevis helt varm og helt kold).

Reserve dele se s. 3

1	Termostatgreb	38391000
2	Roset	96452000
3	Bøsning	97439000
4	Monteringsskrue	96454000
5	Monteringsplade	96447000
6	Temperaturregulering	96633000
7	Snavsfilter	97367000
8	Kontraventil	96655000
9	Forlængersæt 25 mm	13595000
10	Forlængersæt 25 mm	13596000

Dansk

Fejl	Årsag	Hjælp
For lidt vand	-Forsyningstrykket er ikke højt nok -Smudsfangsien er snavset -Sien mellem bruser og slange er snavset	-Afprøv forsyningstrykket -Rengør smudsfangsien -Rengør sien mellem bruser og slange
Kryds-flow, varmt vand i koldt vandsledning og omvendt	-Kontraventilen er snavset eller utæt.	-Udskift kontraventil
Udløbstemperaturen stemmer ikke overens med den indstillede temperatur	-Termostaten er ikke justeret -For lav varmtvands-temperatur	-Juster termostaten! -Forhøj varmtvands-temperaturen fra 42 C til 65 C
Temperaturregulering ikke mulig	-Termostatelementet er snavset eller tilkalket -Vend indbygningsdelen 180°	-Ved ny-installation er vandtilslutningen forbyttet (skal være koldt til højre - varmt til venstre eller også er grundkroppen drejet 180) -Sikkerhedsspærren er ude af funktion
Defekt fjeder	-Rengør fjeder og trykknop eller udskift delene -Trykknappen tilkalket	-Rengør fjeder og trykknop eller udskift delene -Rengør fjeder og trykknop eller udskift delene

Godkendelse

	P-IX	DVGW	SVGW	WRSA	KIWA	ACS	NF
27070000						X	
27418XXX							
28420000						X	
28435XXX						X	

Rengøring

Enkel rengøring: Det er let at fjerne kalkaflejringer fra stråledyserne.

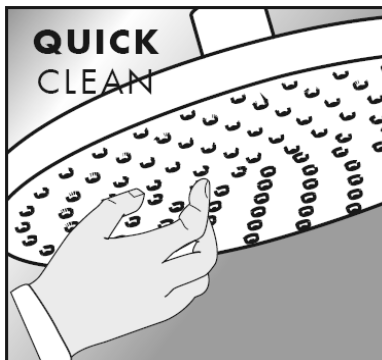

Rengøring

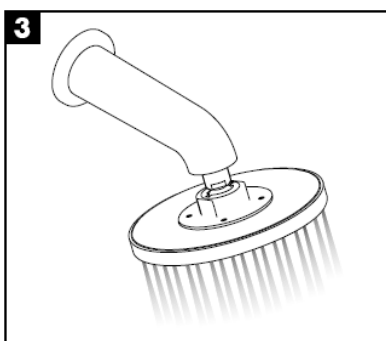
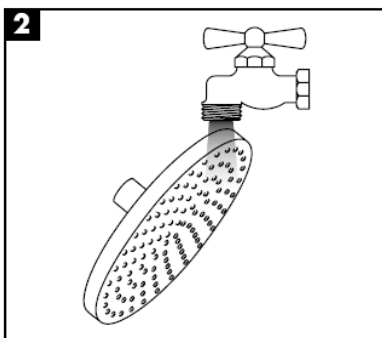
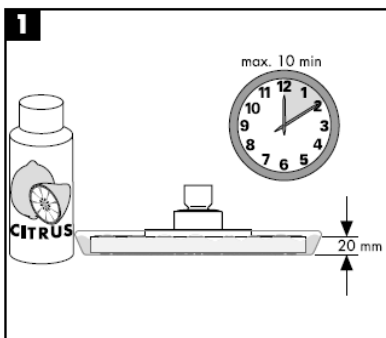

hansgrohe

Manual de Instalación



27418XXX

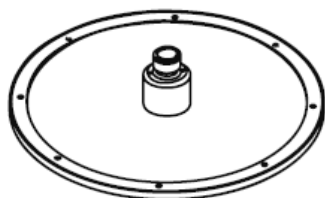

Raindance Royale AIR
28420000

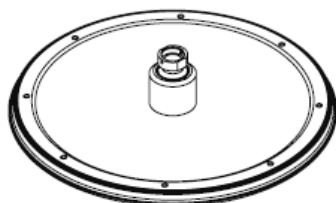

Raindance Royale Classic AIR
28435XXX

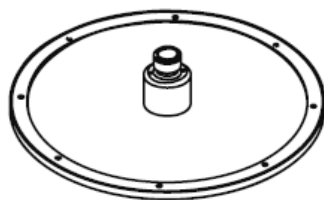

**Raindance Royale
High Flow Set**
27070000

hangrohe

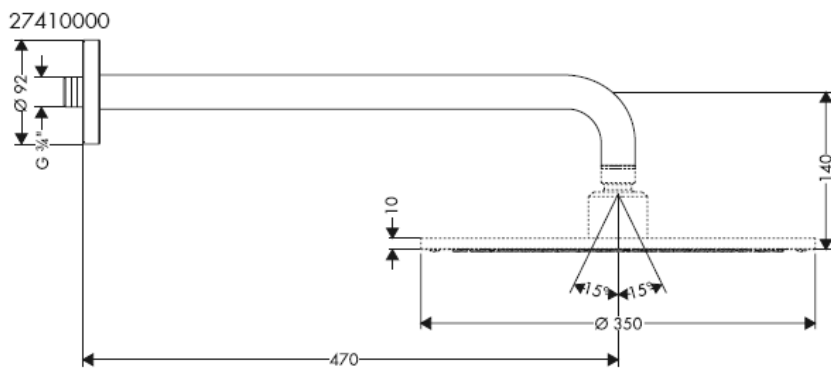
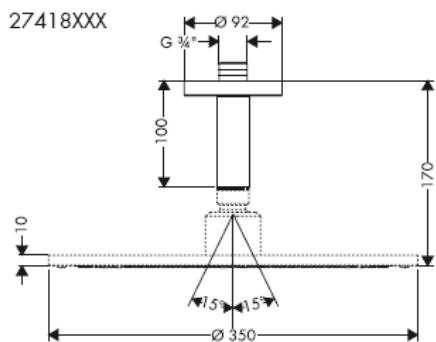
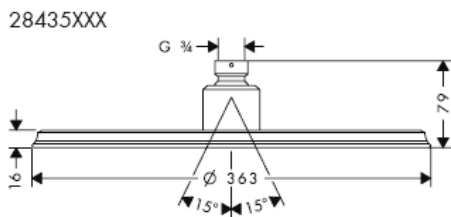
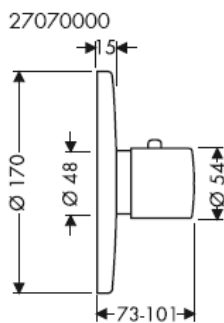
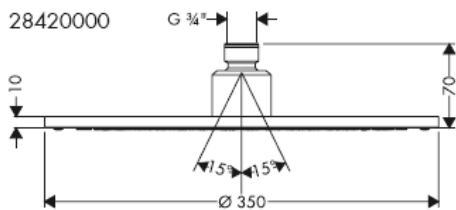

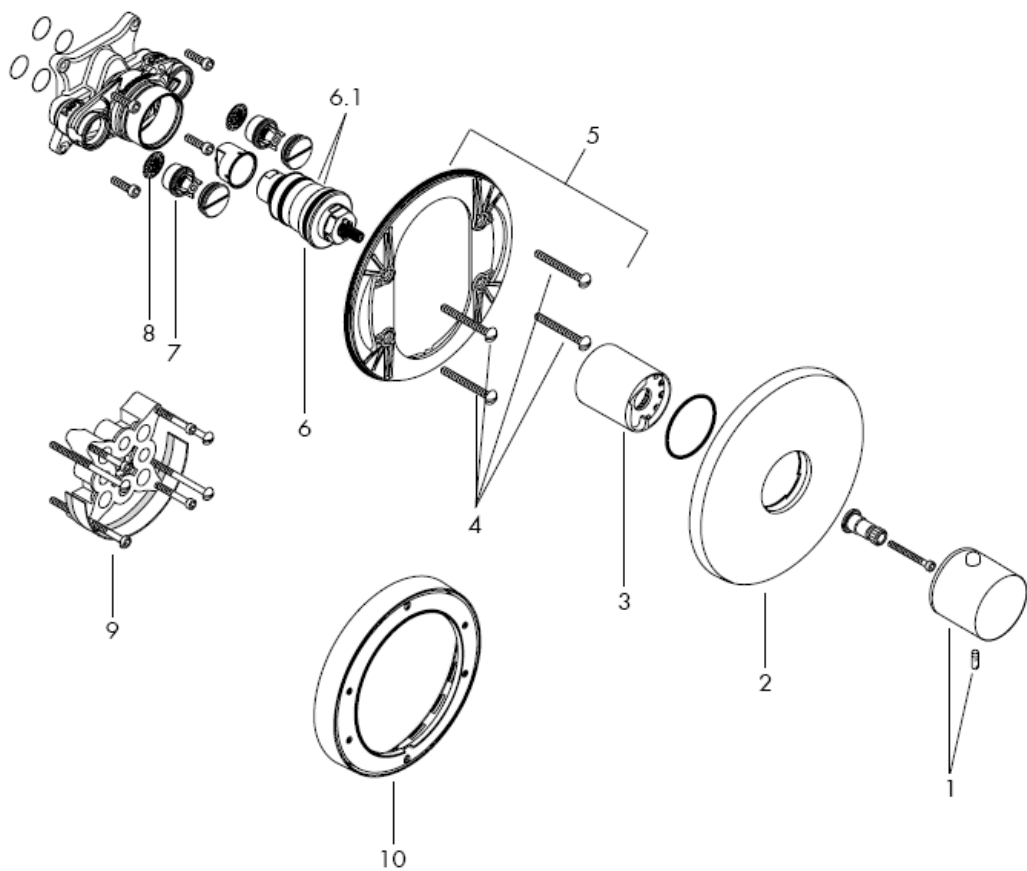

Se possível adaptar às medidas dos azulejos.

Área reforçada necessária da parede

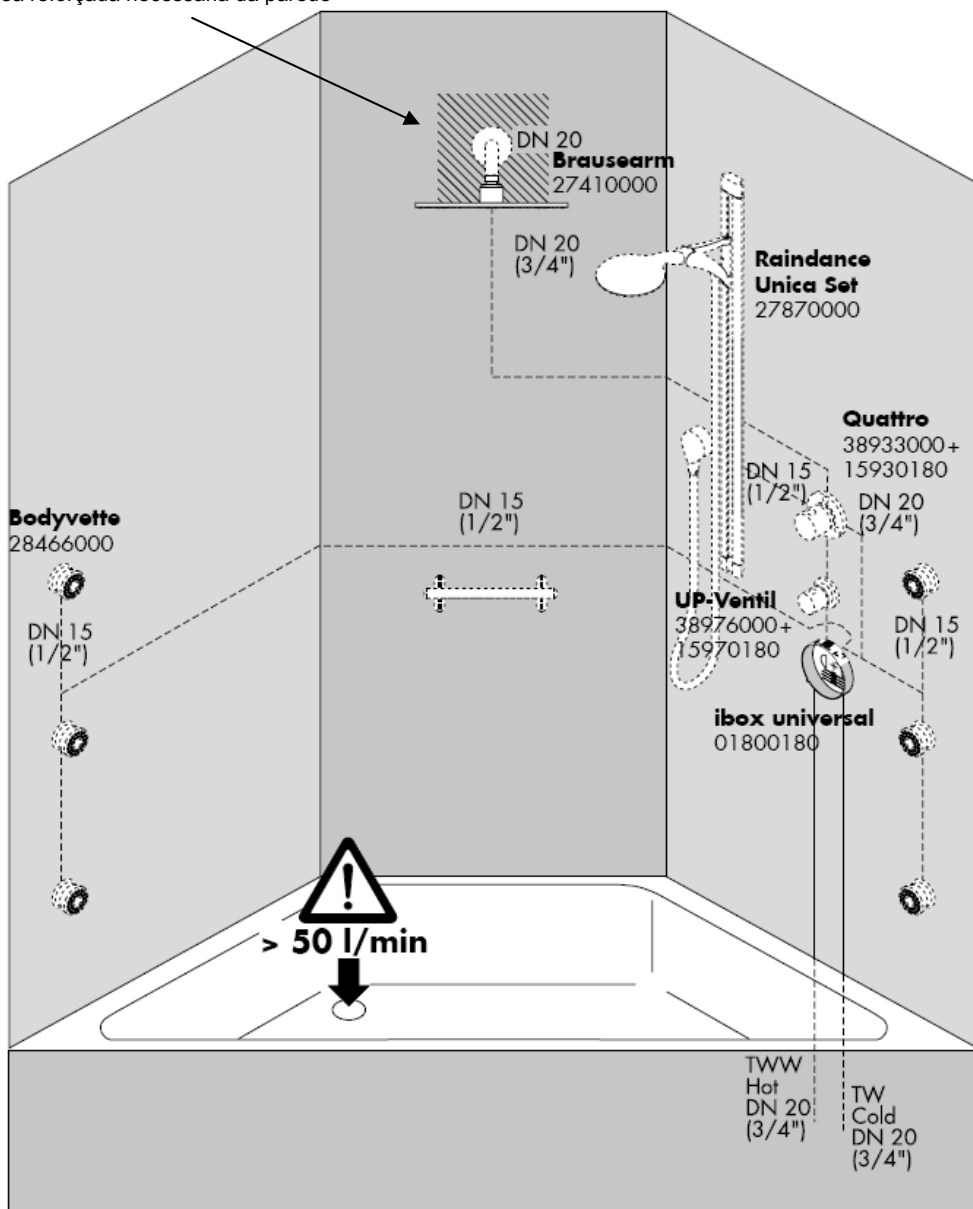

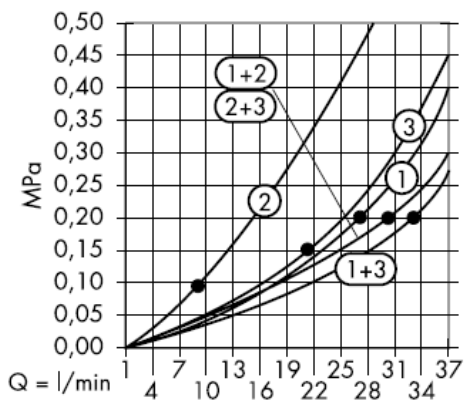

• A partir deste ponto inicia-se o funcionamento correcto.

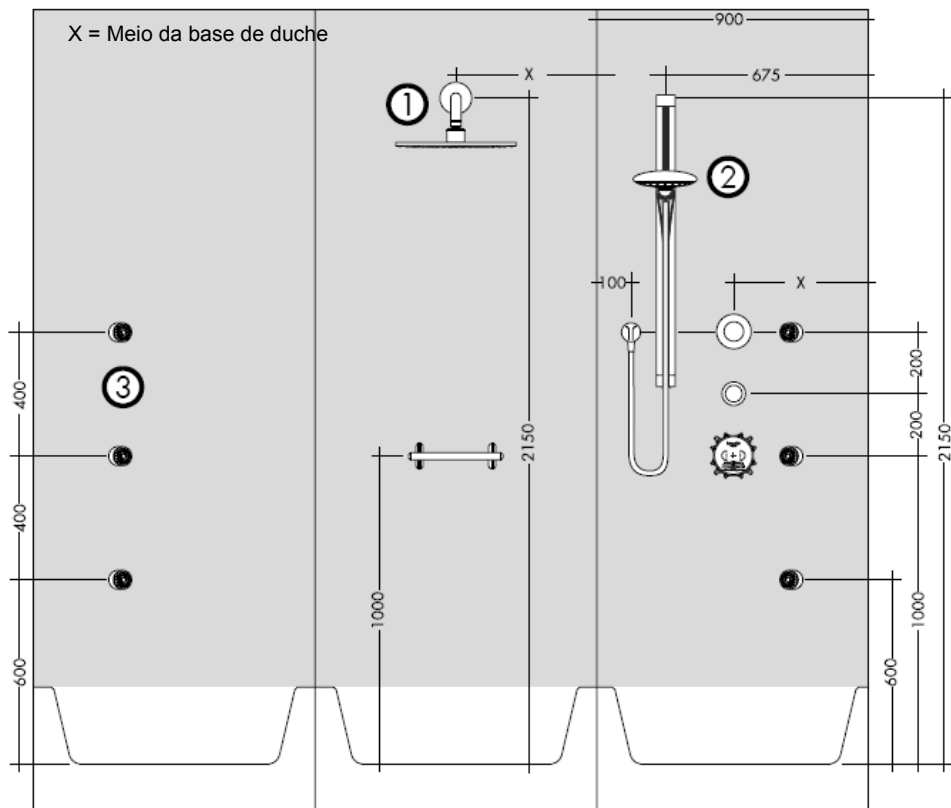

Área reforçada necessária da parede

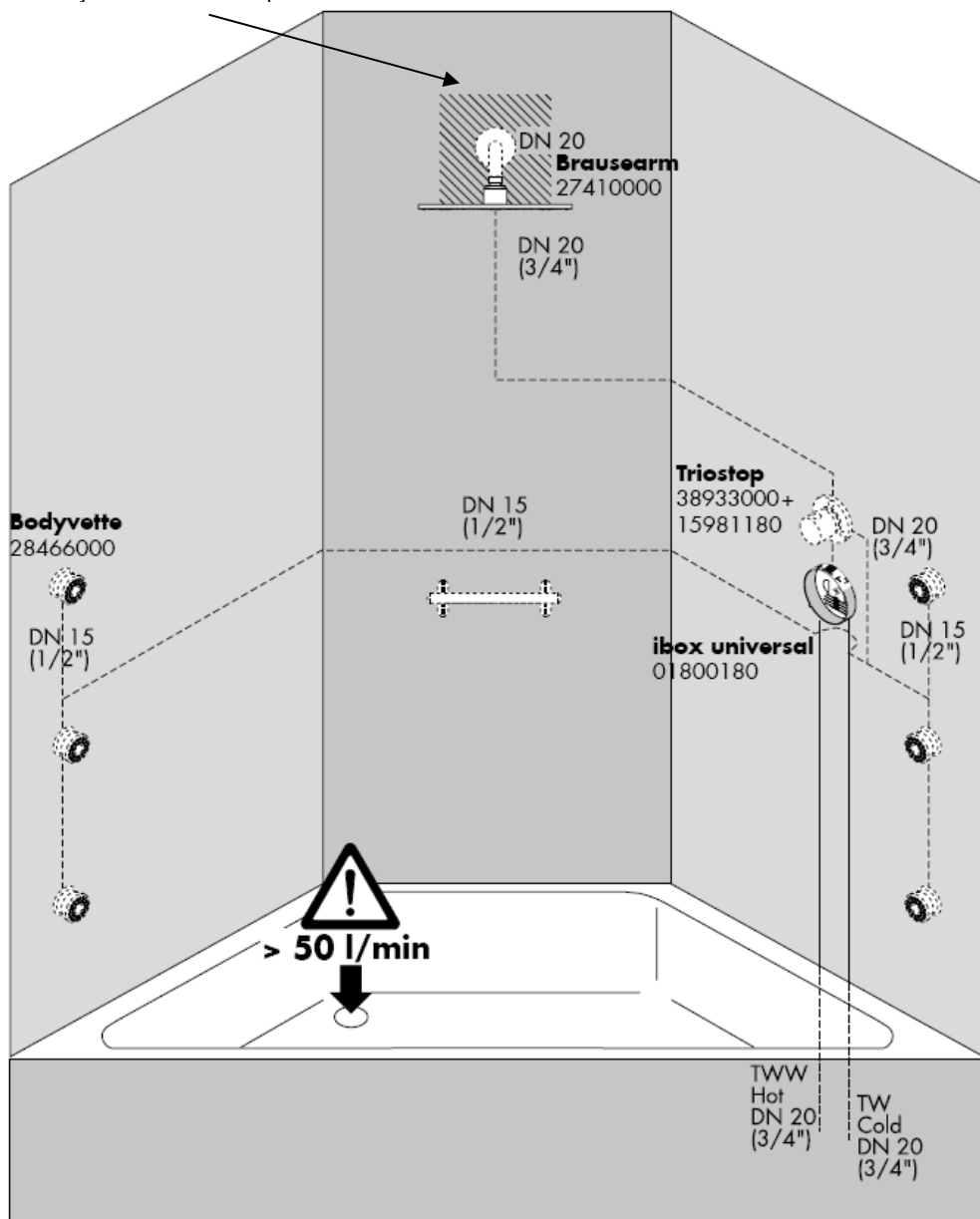

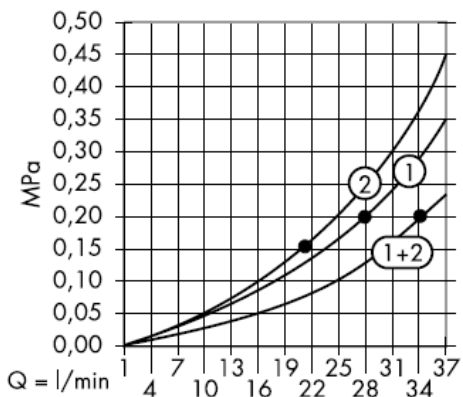

• A partir deste ponto inicia-se o funcionamento correcto.

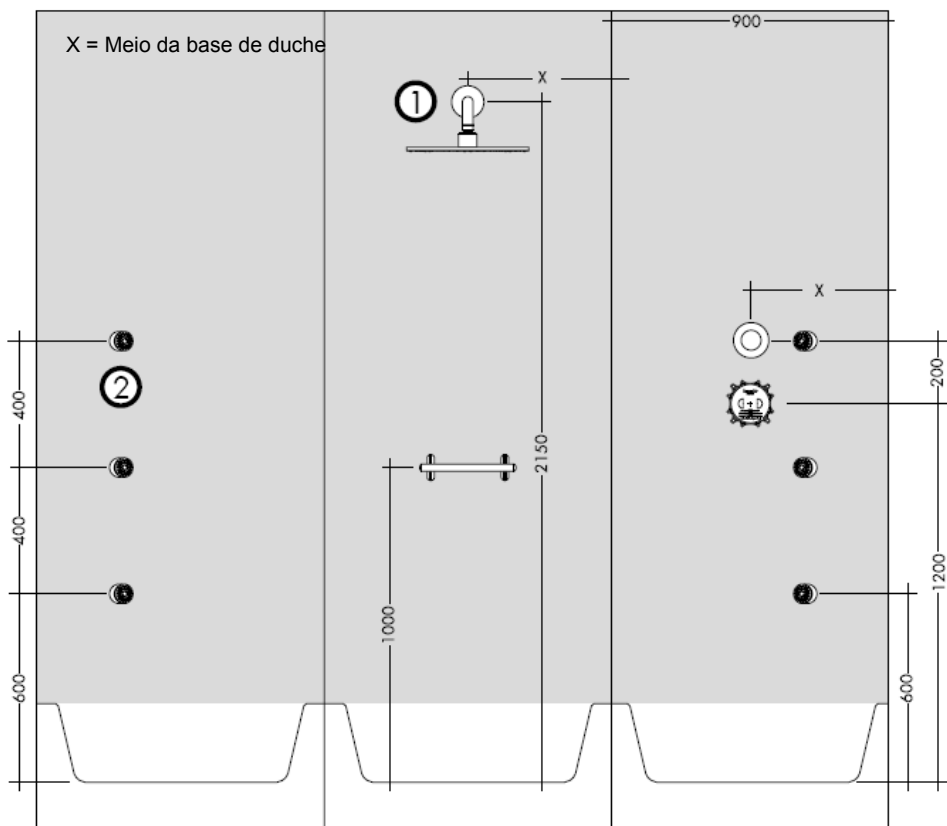

Área reforçada necessária da parede

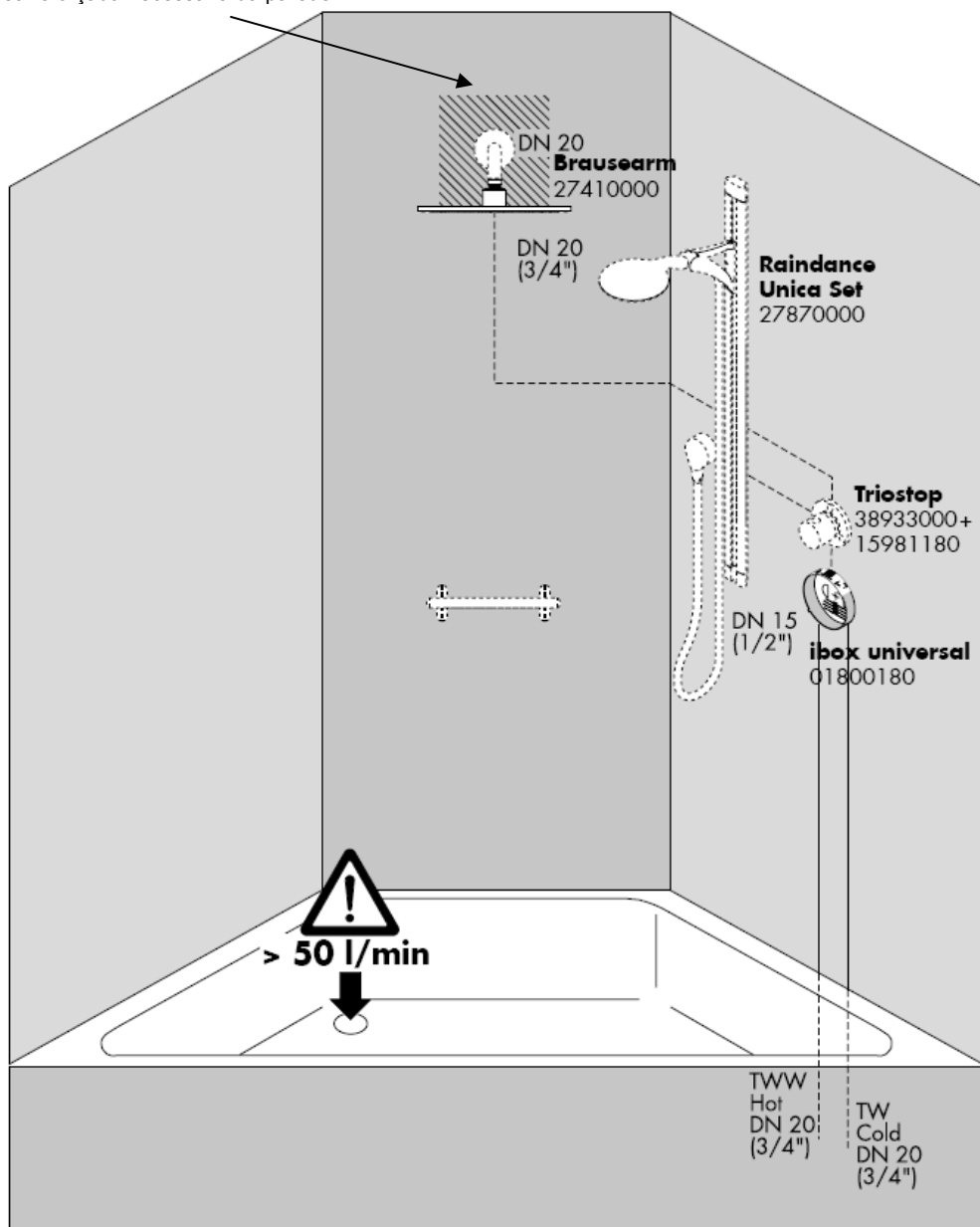

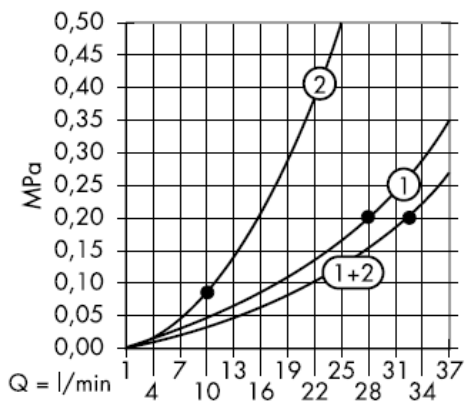

• A partir deste ponto inicia-se o funcionamento correcto.

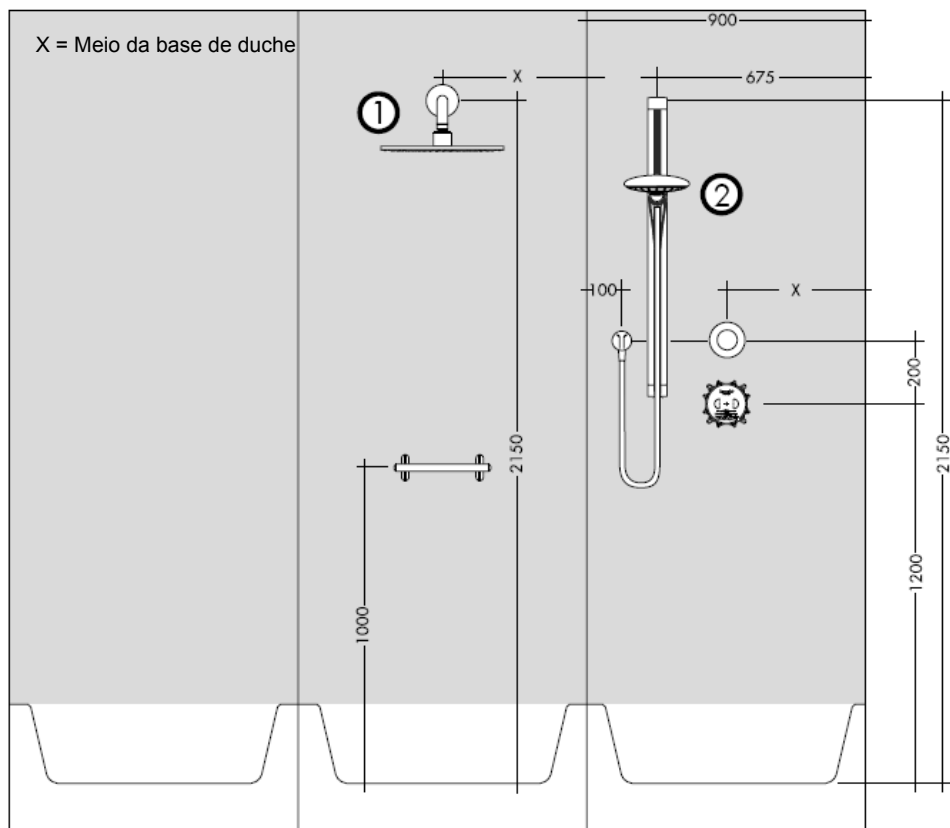

Área reforçada necessária da parede

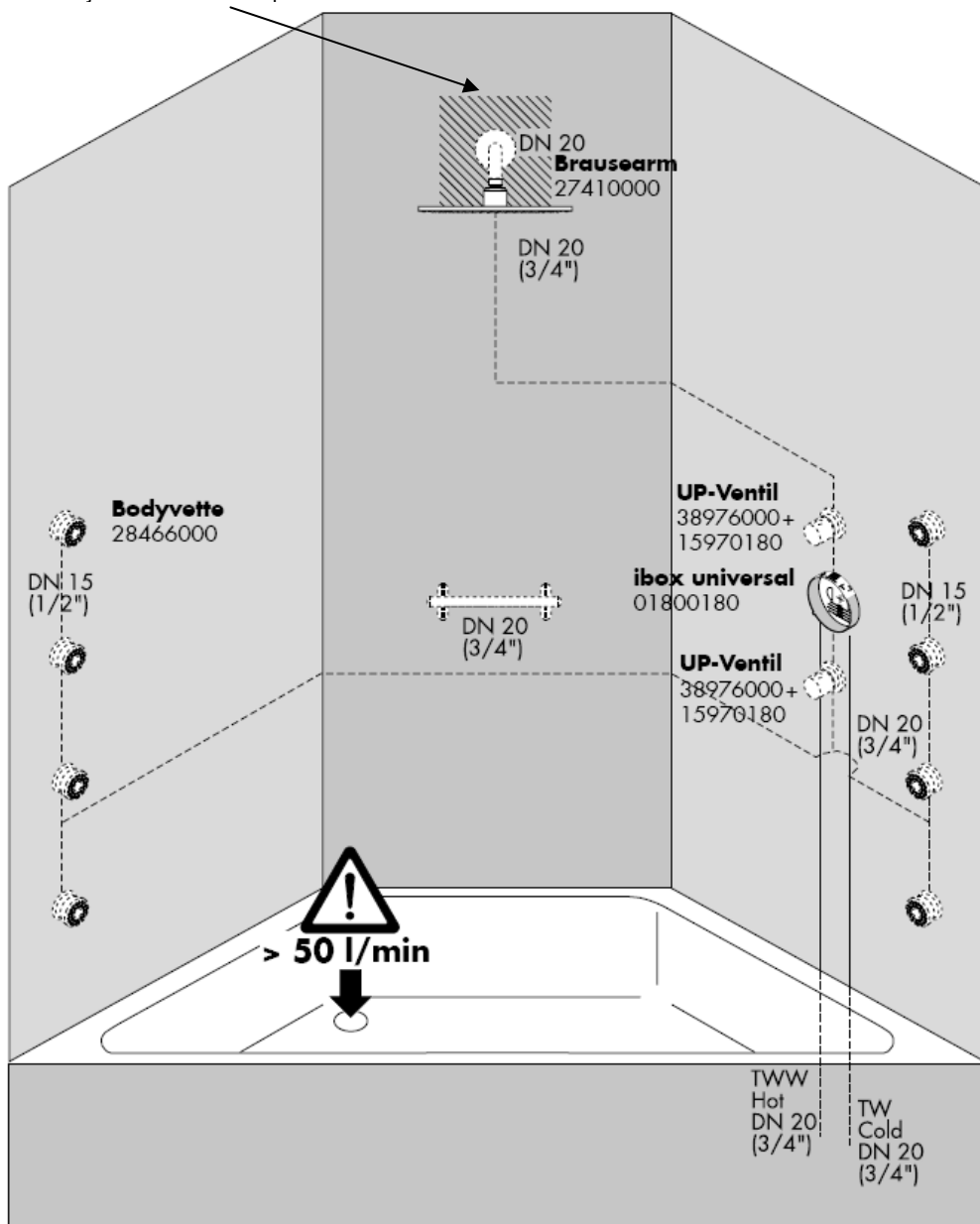

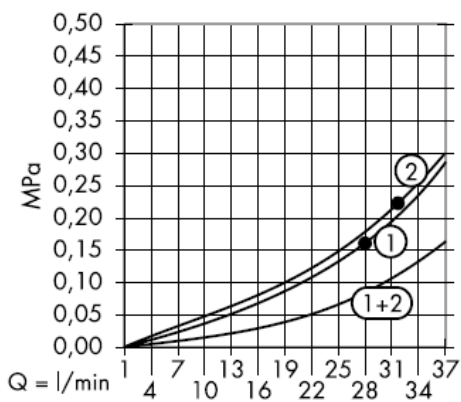

• A partir deste ponto inicia-se o funcionamento correcto.

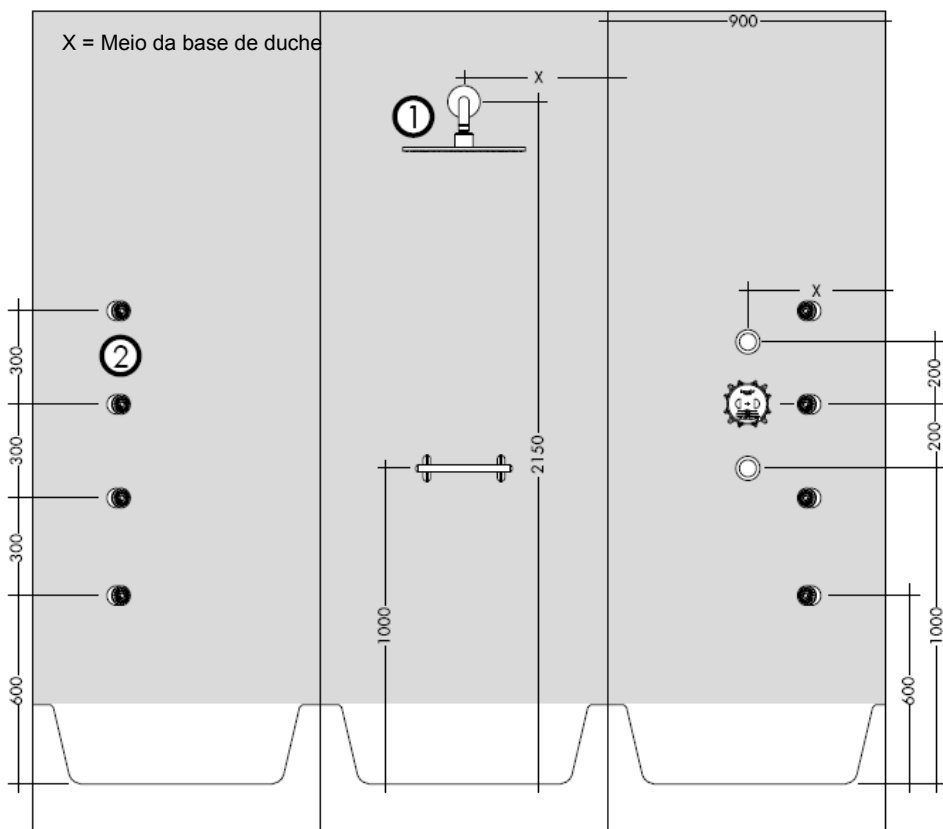

Área reforçada necessária da parede

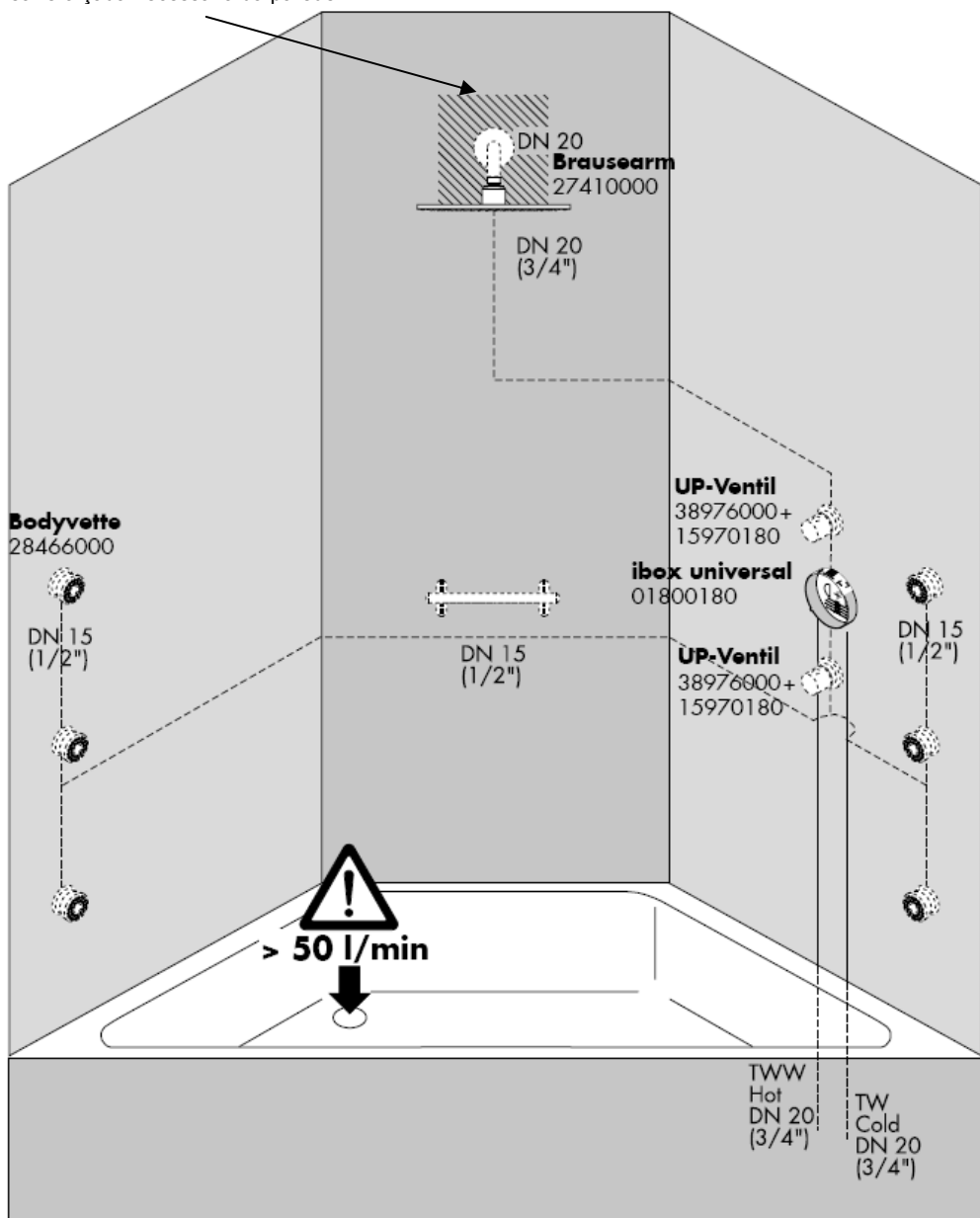

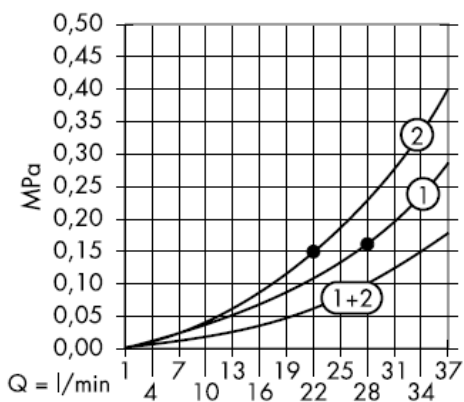

• A partir deste ponto inicia-se o funcionamento correcto.

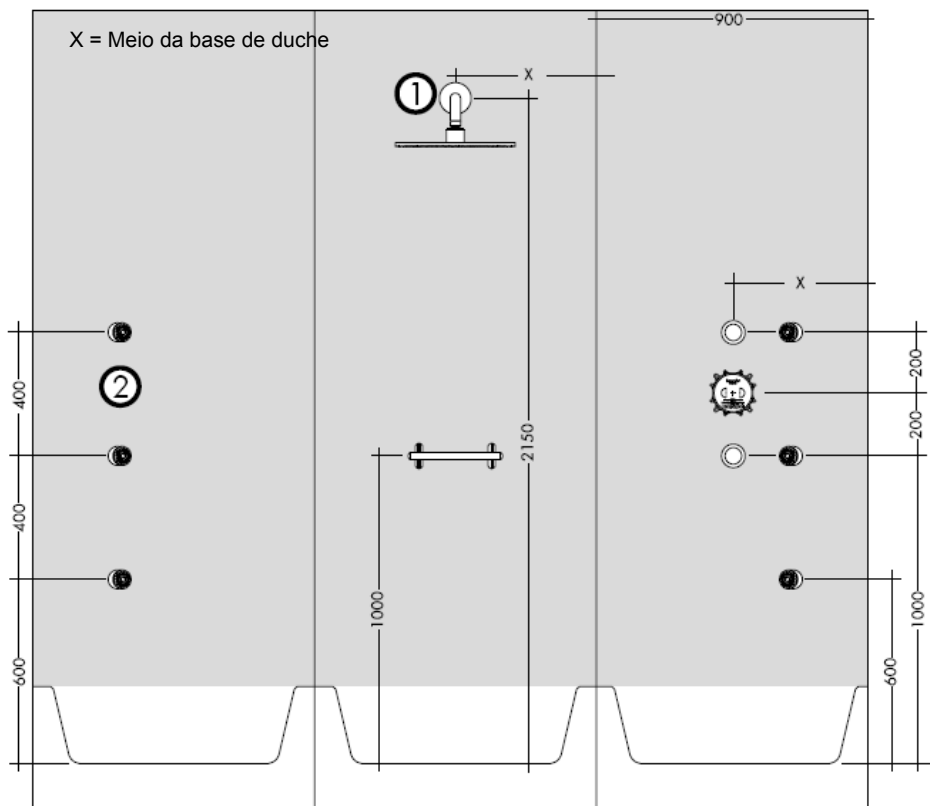

Área reforçada necessária da parede

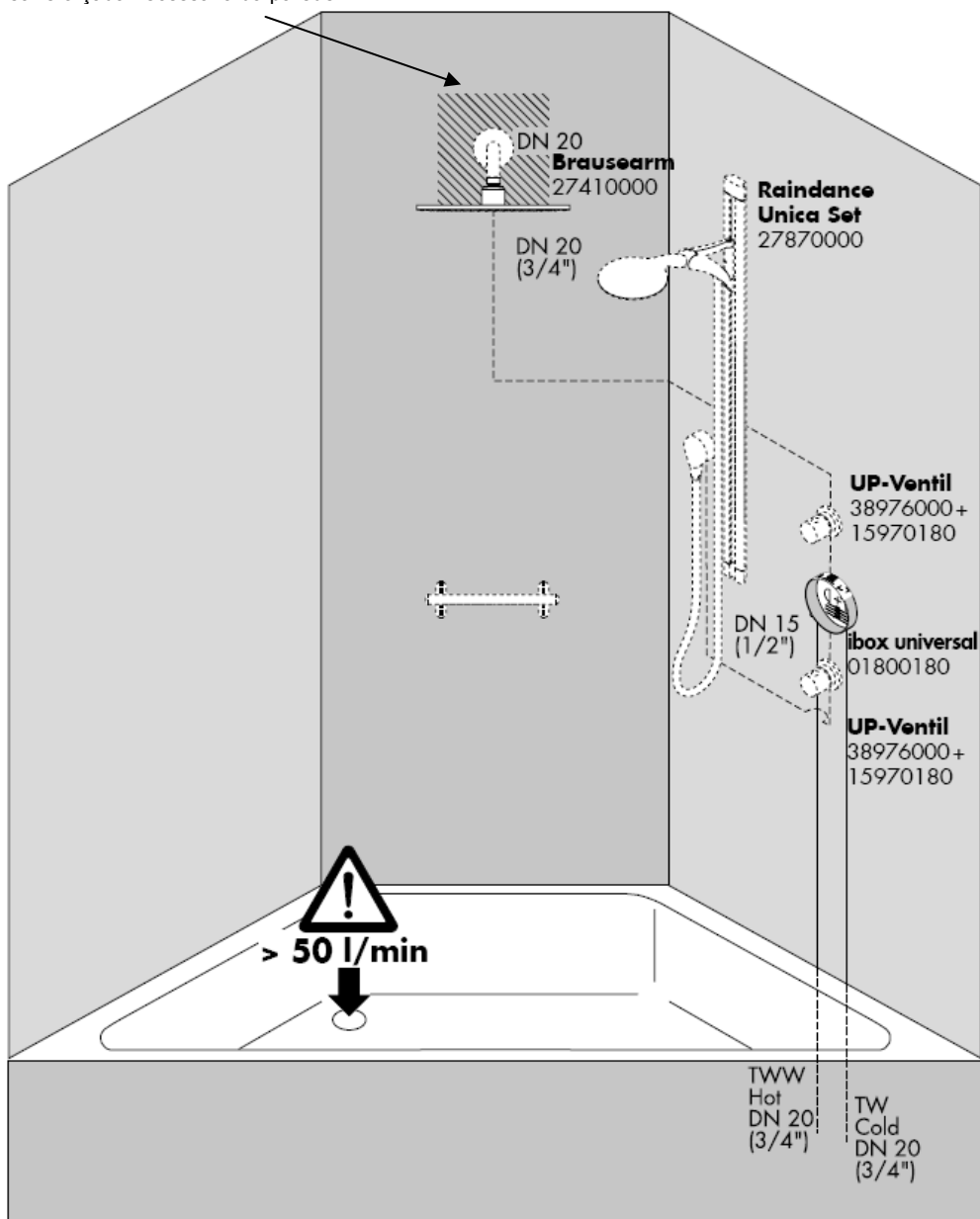

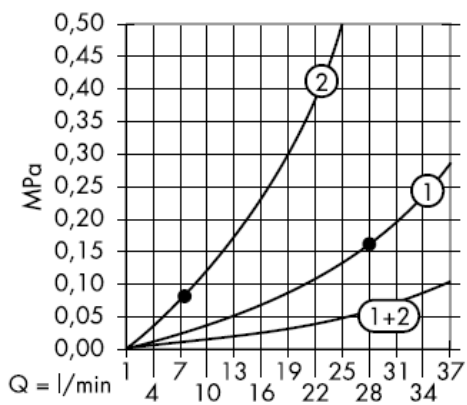

• A partir deste ponto inicia-se o funcionamento correcto.

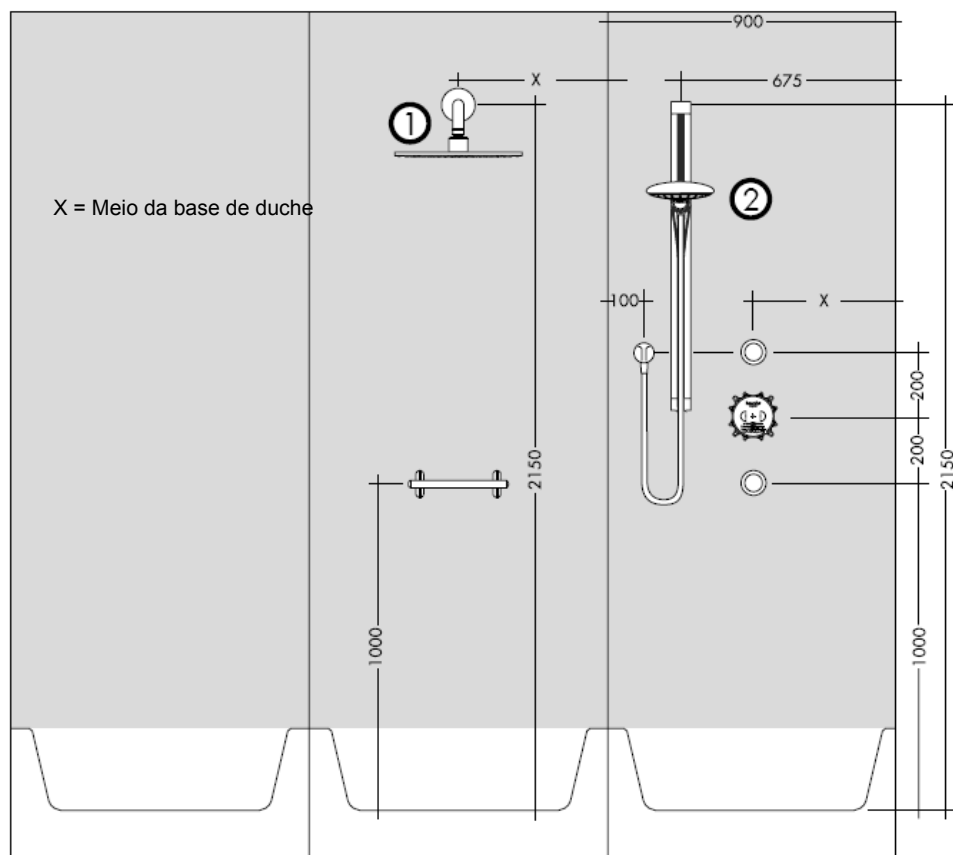

Área reforçada necessária da parede

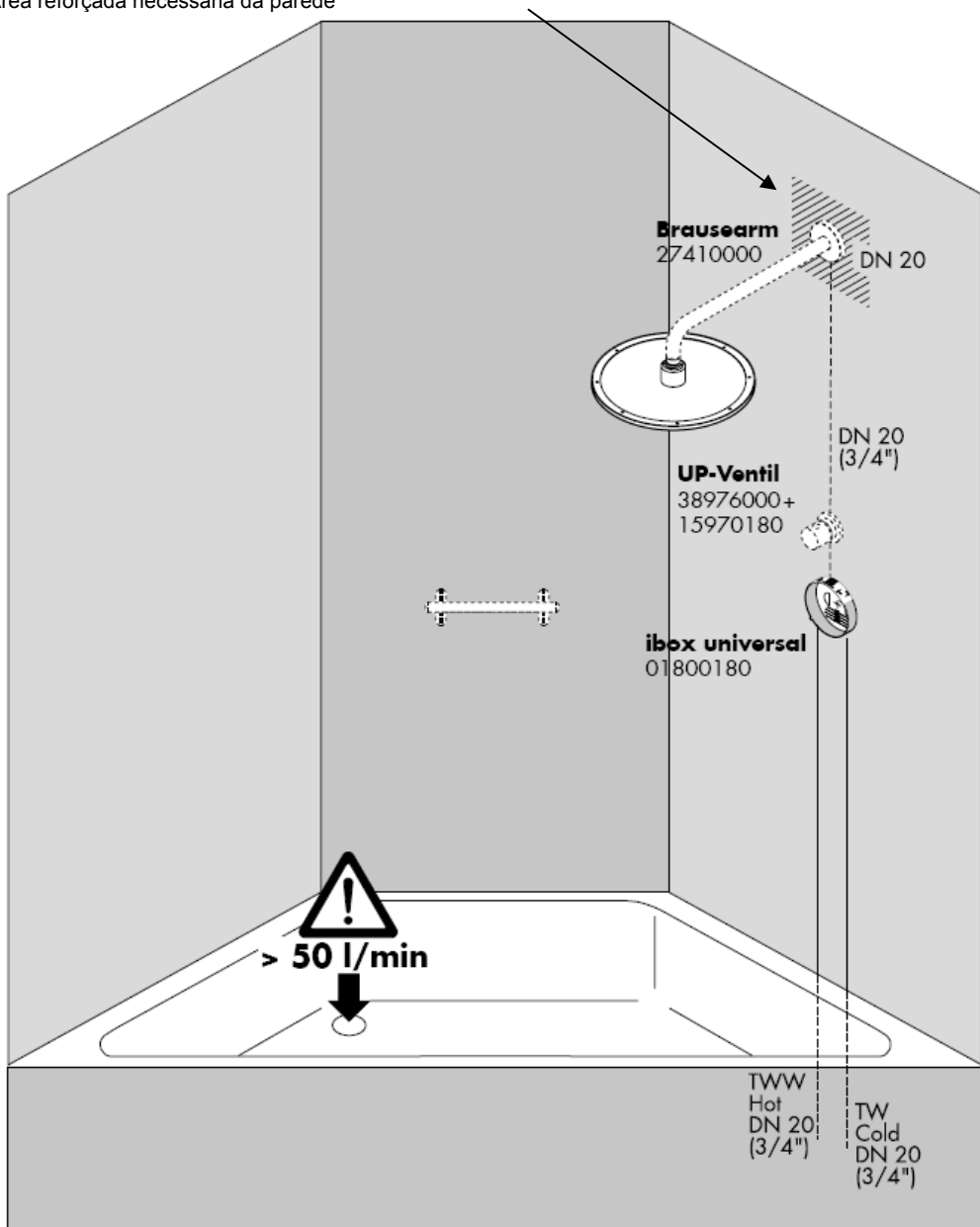

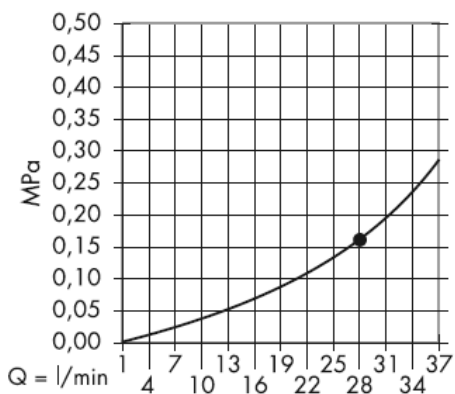

- A partir deste ponto inicia-se o funcionamento correcto.

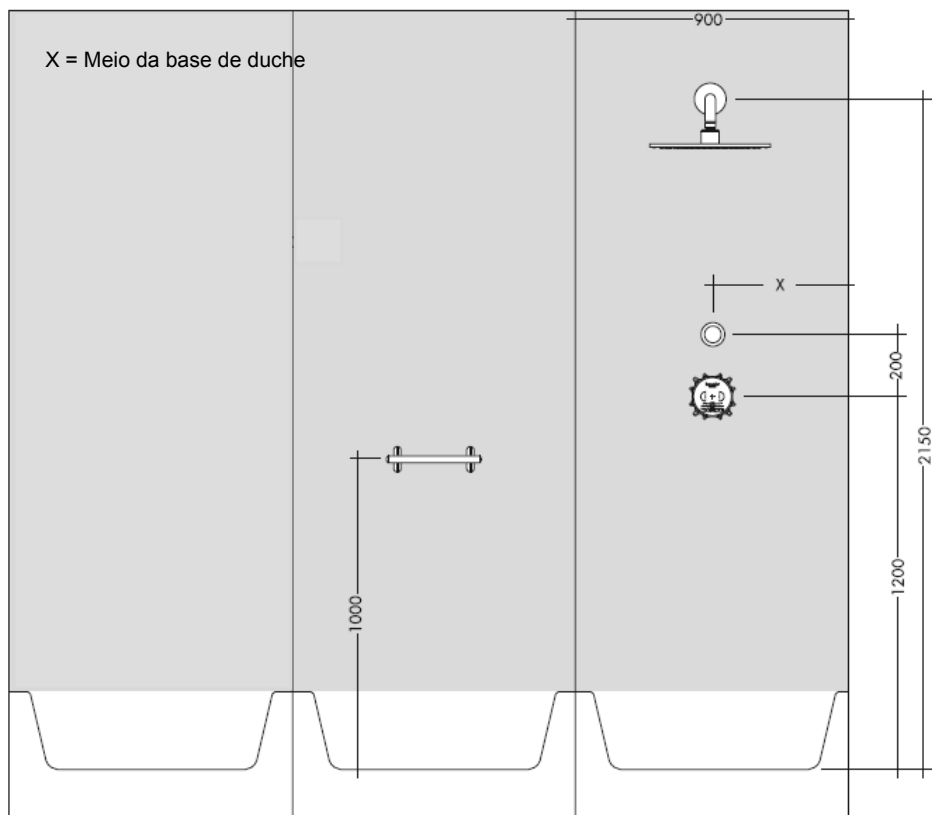

Área reforçada necessária da parede

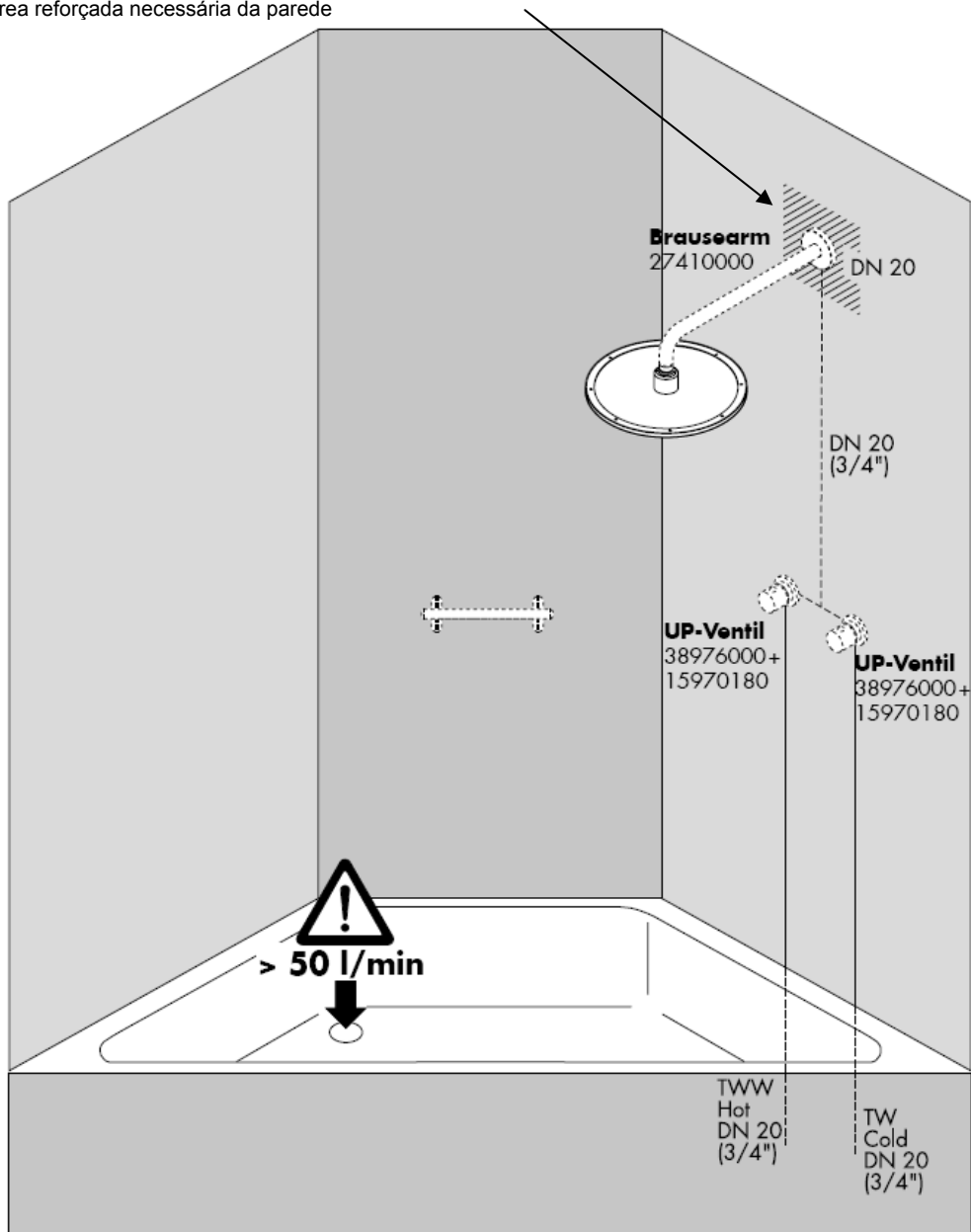

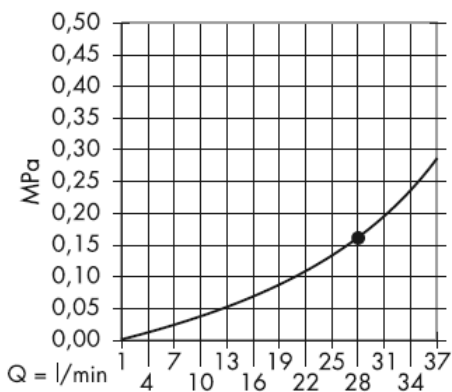

- A partir deste ponto inicia-se o funcionamento correcto.

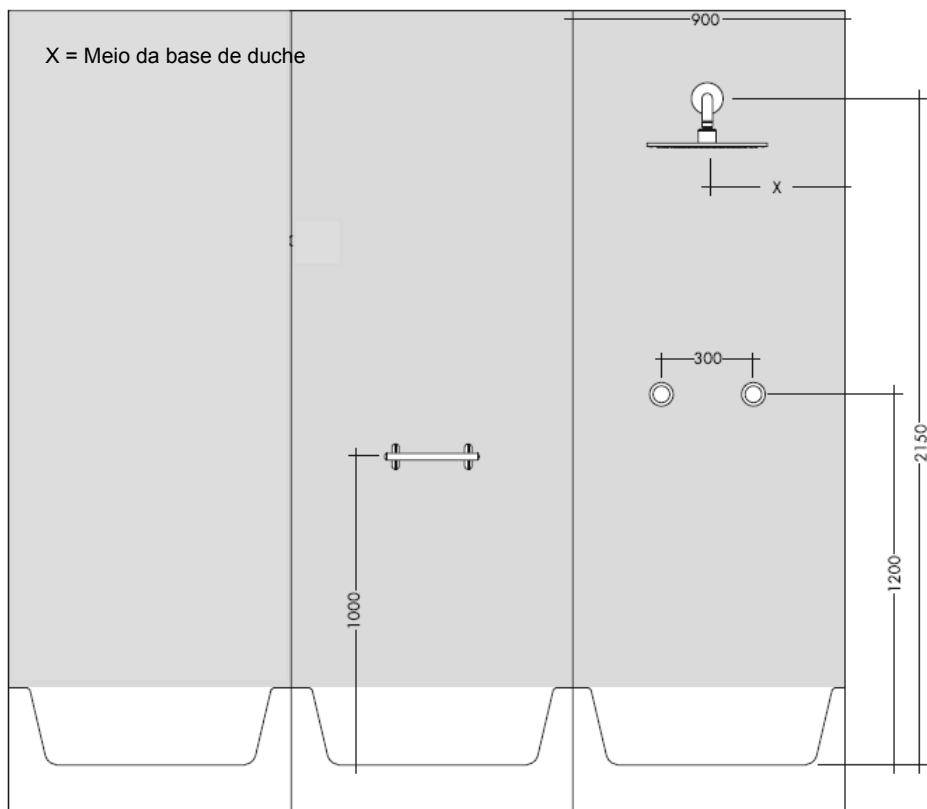

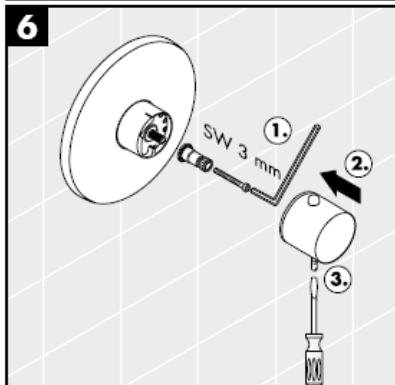
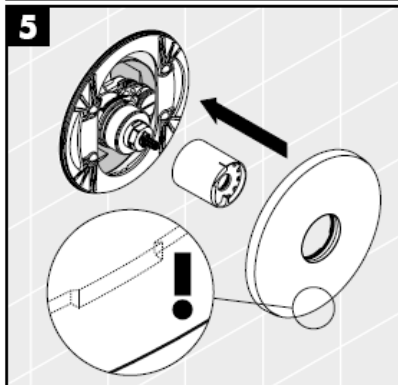
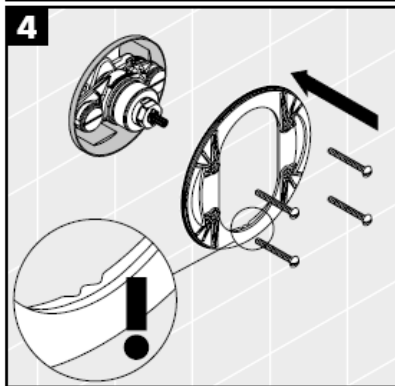
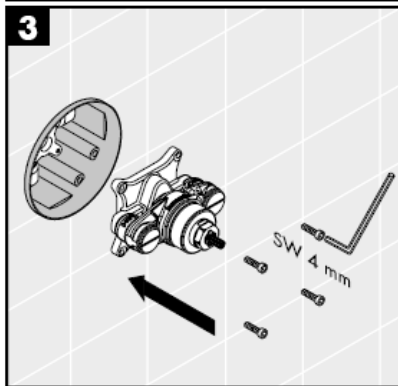
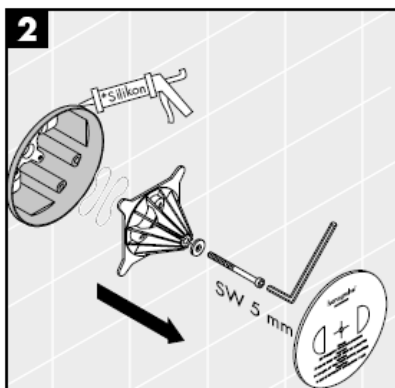
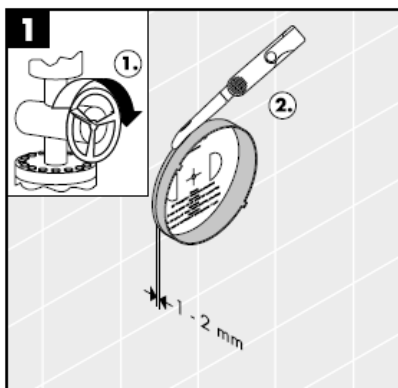

Silicone (sem ácido acético)

Graças à função de segurança pode-se regular a temperatura máxima por exemplo max. 42°C.

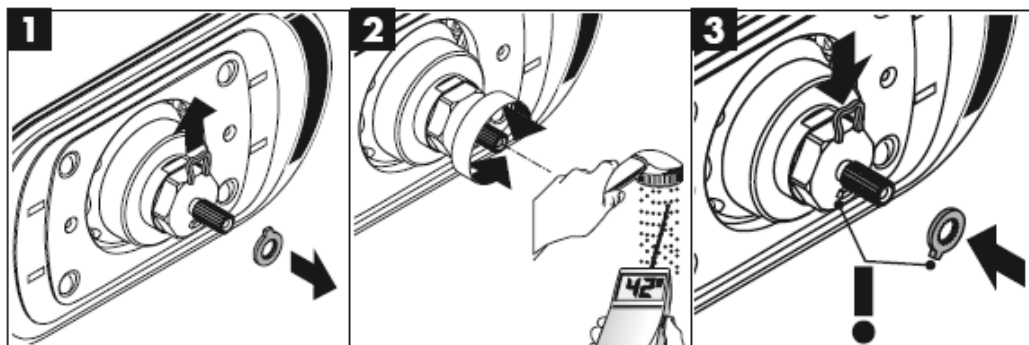

Afinação

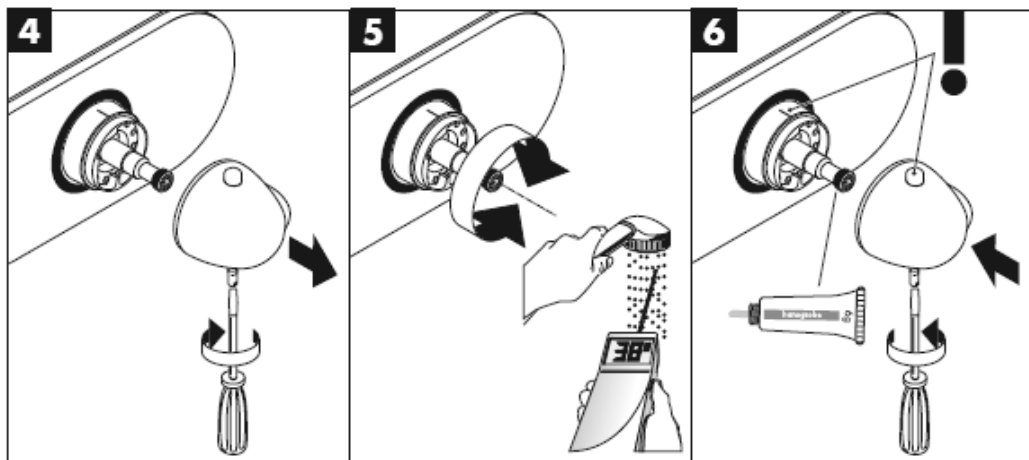



Assim que o chuveiro estiver em funcionamento este tem, juntamente com o braço do chuveiro, um peso de aprox. 10 kg. Por esse motivo, só pode ser utilizado material de fixação adequado para o respectivo tipo de parede! Os parafusos e buchas incluídos no v

Use apenas material de fixação adequado para alvenaria! Os parafusos e buchas incluídos são apenas para alvenaria maciça.

A capacidade de escoamento deve ser devidamente dimensionada.

O bom funcionamento é apenas garantido em combinação com a termostática High Flow da Hansgrohe.

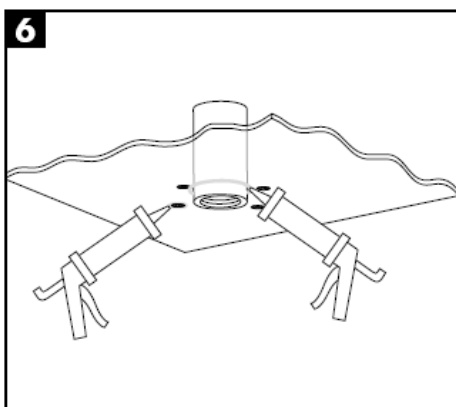
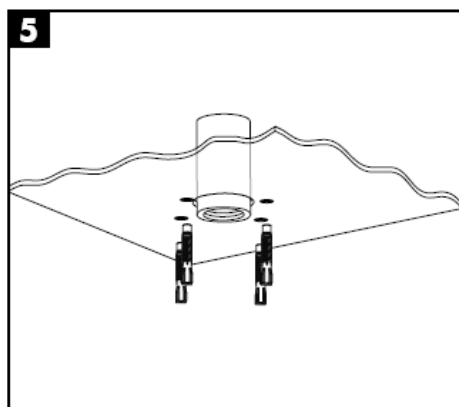
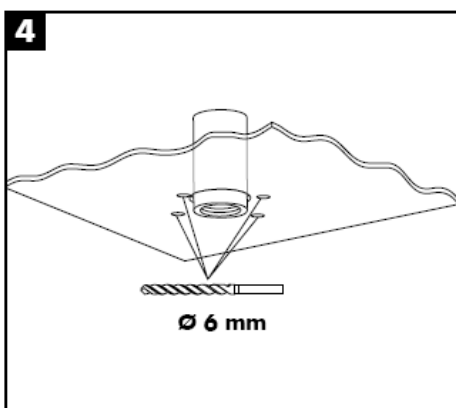
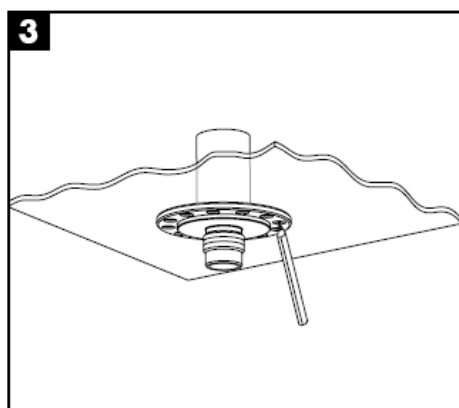
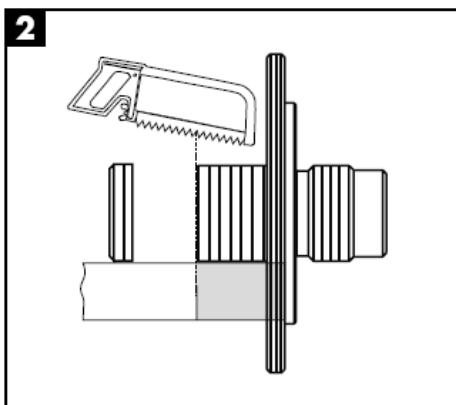
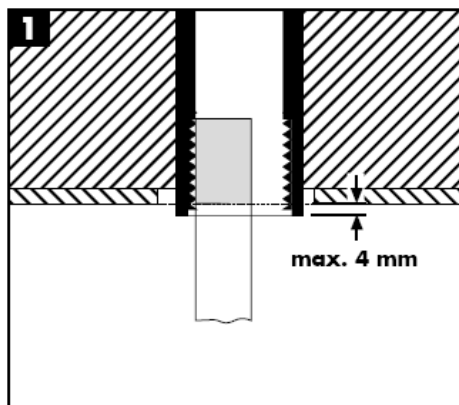

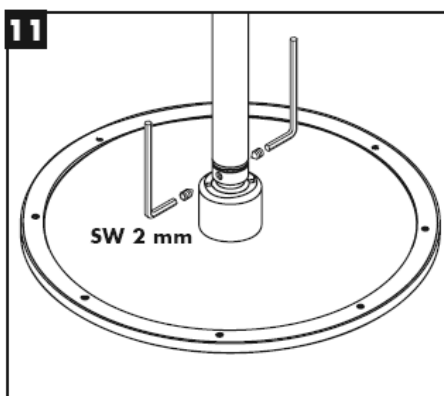
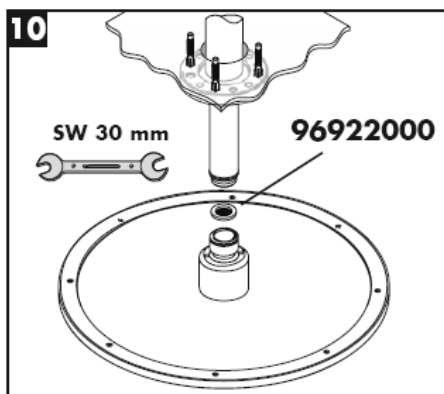
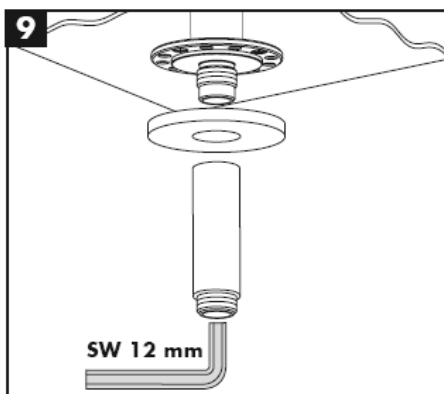
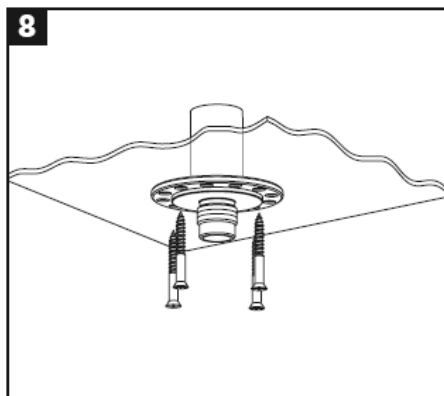
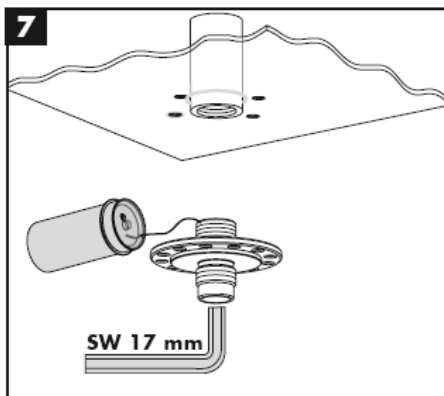

O filtro de rede deve ser colocado para proteger o chuveiro de areias e resíduos provenientes da tubagem. Resíduos e areias podem danificar componentes, ou provocar mau funcionamento do chuveiro; as avarias assim provocadas anulam a nossa responsabilidade e anulam a nossa garantia.

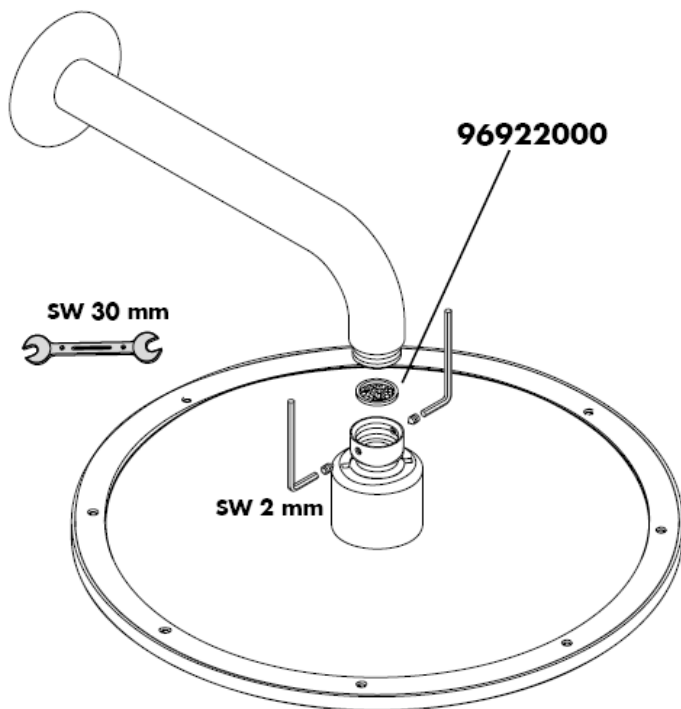

Montagem

Atenção! A misturadora deve ser instalada, purgada e testada de acordo com as normas em vigor!

Afinação

Torna-se necessário afinar a misturadora se a temperatura da água não condiz com a indicada na escala graduada. Para afinar a temperatura proceder assim:

Rode o manípulo até a água sair à temperatura de 38 °C. Desaperte o parafuso do manípulo graduado e rodeo até a posição de 38 °C.

Encaixe de novo o manípulo e aperte o parafuso (ver página 22).

Limite de temperatura

A temperatura é regulável até 38 °C, altura em que intervém o ressalto de segurança. Quando se desejar uma temperatura superior, pode fazê-lo, premindo o botão vermelho de segurança e rodando o manípulo.

Safety Function

Graças à função de segurança pode-se regular a temperatura máxima por exemplo max. 42°C. ver página 21.

Dados Técnicos

Pressão de funcionamento: max. 1 MPa
Pressão de func. recomendada: 0,1 – 0,5 MPa
Pressão testada: 1,6 MPa
(1 MPa = 10 bar = 147 PSI)
Temperatura da água quente: max. 80° C
Temp. água quente recomendada: 65° C
Caudal: ca. 58 l/min 0,3 MPa

Manutenção

A misturadora termostática não necessita de manutenção em especial. As válvulas anti-retorno devem ser verificadas regularmente de acordo com a DIN EN 1717 segundo os regulamentos nacionais ou regionais (pelo menos uma vez por ano). Verifique nesta ocasião também a sujidade e o estado do cartucho (6.1). Depois da montagem do cartucho (6) testar a temperatura da água, como descrito no ponto "Afinação". Verifique previamente se o abastecimento de água quente está ligado e se está no máximo da temperatura.

Para garantir um funcionamento suave do elemento termostático é necessário de vez em quando rodar totalmente o manípulo da termostática da posição quente para a fria.

Peças de substituição ver página 3

1	Manípulo termostática	38391000
2	Cápsula	96452000
3	Cápsula	97439000
4	Parafusos de fixação	96454000
5	Sede	96447000
6	Elemento termostático	96633000
7	Filtro	97367000
8	Válvula anti-retorno	96655000
9	Crescente 25 mm	13595000
10	Crescente 25 mm	13596000

Português

Falha	Causa	Solução
Água insuficiente	-Pressão não adequada -Filtro do regulador sujo -Filtro do vedante do chuveiro sujo	-Verificar a pressão da água -Limpar os filtros -Limpar o filtro entre o chuveiro e o tubo flexível
Fluxos cruzados, água quente a ser forçada a entrar no tubo da água fria, ou vice-versa, quando a misturadora está fechada.	-Válvula anti-retorno suja ou com fugas	-Trocar a válvula anti-retorno
A temperatura da água não corresponde à temperatura seleccionada	-A misturadora termos tática não foi ajustada -Temperatura da água quente muito baixa	-Ajustar a misturadora termostática -Aumentar a temperatura da água quente para 42° a 65° C.
Não é possível regular a temperatura	-Regulador da temperatura sujo ou calcificado -Instalar o corpo virado 180°	-Para novas instalações: Corpo instalado incorrectamente (deve ser: fria direita, quente esquerda) ou instalado com uma rotação de 180° -Botão de segurança não funciona
Mola defeituosa	-Limpar a mola e/ou o botão, substitua se necessário -Botão calcificado	-Limpar a mola e/ou o botão, substitua se necessário -Limpar a mola e/ou o botão, substitua se necessário

Marca de controlo

	P-IX	DVGW	SVGW	WRSA	KIWA	ACS	NF
27070000						X	
27418XXX							
28420000						X	
28435XXX						X	

Limpeza

Simplemente limpo: o calcário pode ser simplesmente retirado das saliências através de fricção.

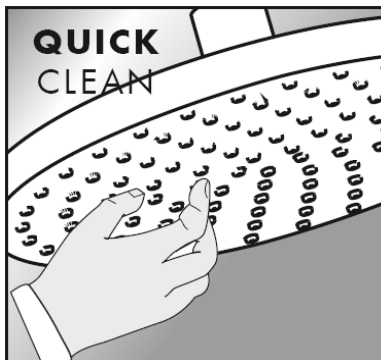

Instruções de Limpeza

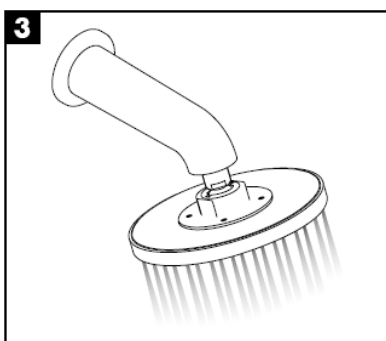
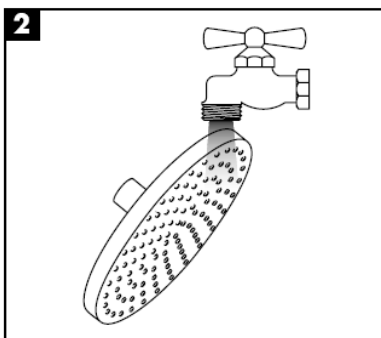
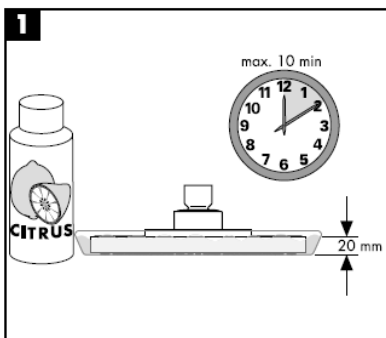

hansgrohe

Instrukcja montażu



27418XXX

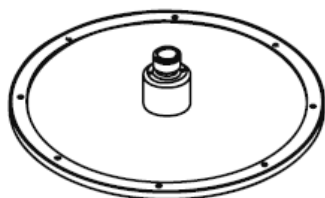

Raindance Royale AIR
28420000

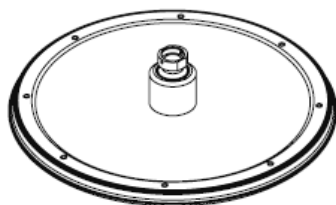

Raindance Royale Classic AIR
28435XXX

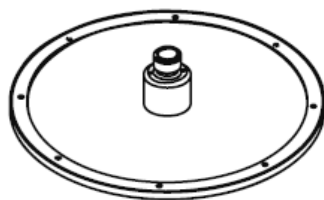

**Raindance Royale
High Flow Set**
27070000

hansgrohe

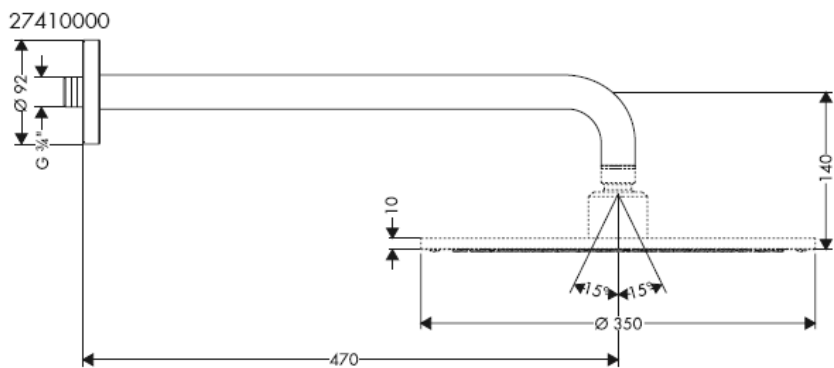
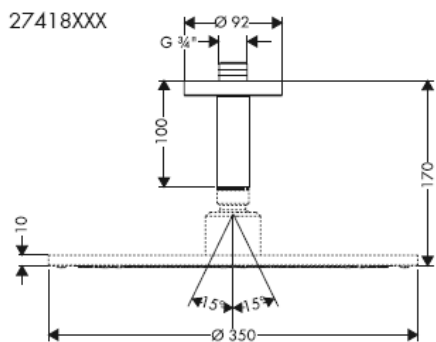
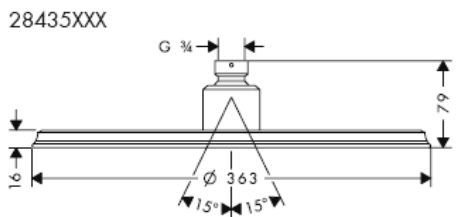
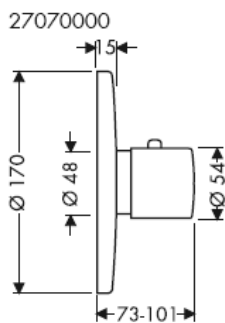
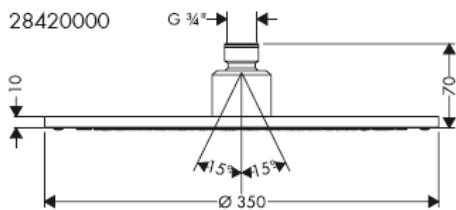

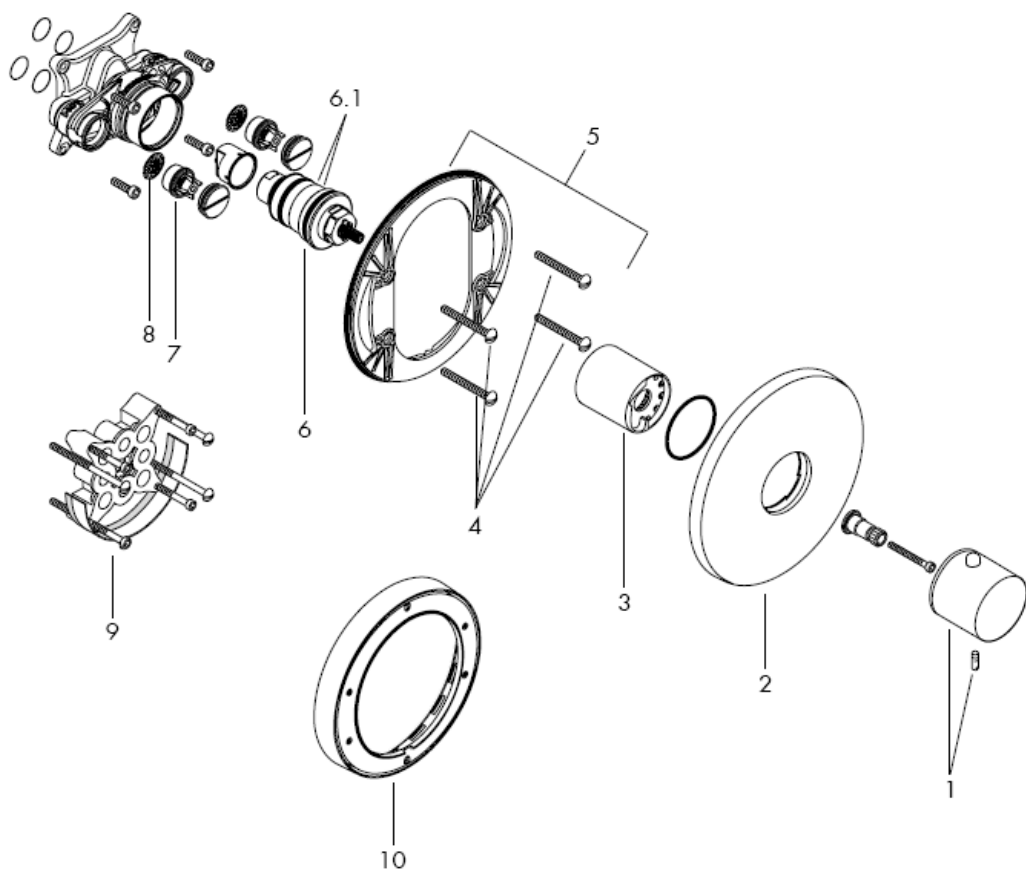

Wymiary należy możliwie dopasować do układu płytek ceramicznych na ścianie.

Strefa doniezbędnego wzmocnienia ścianki

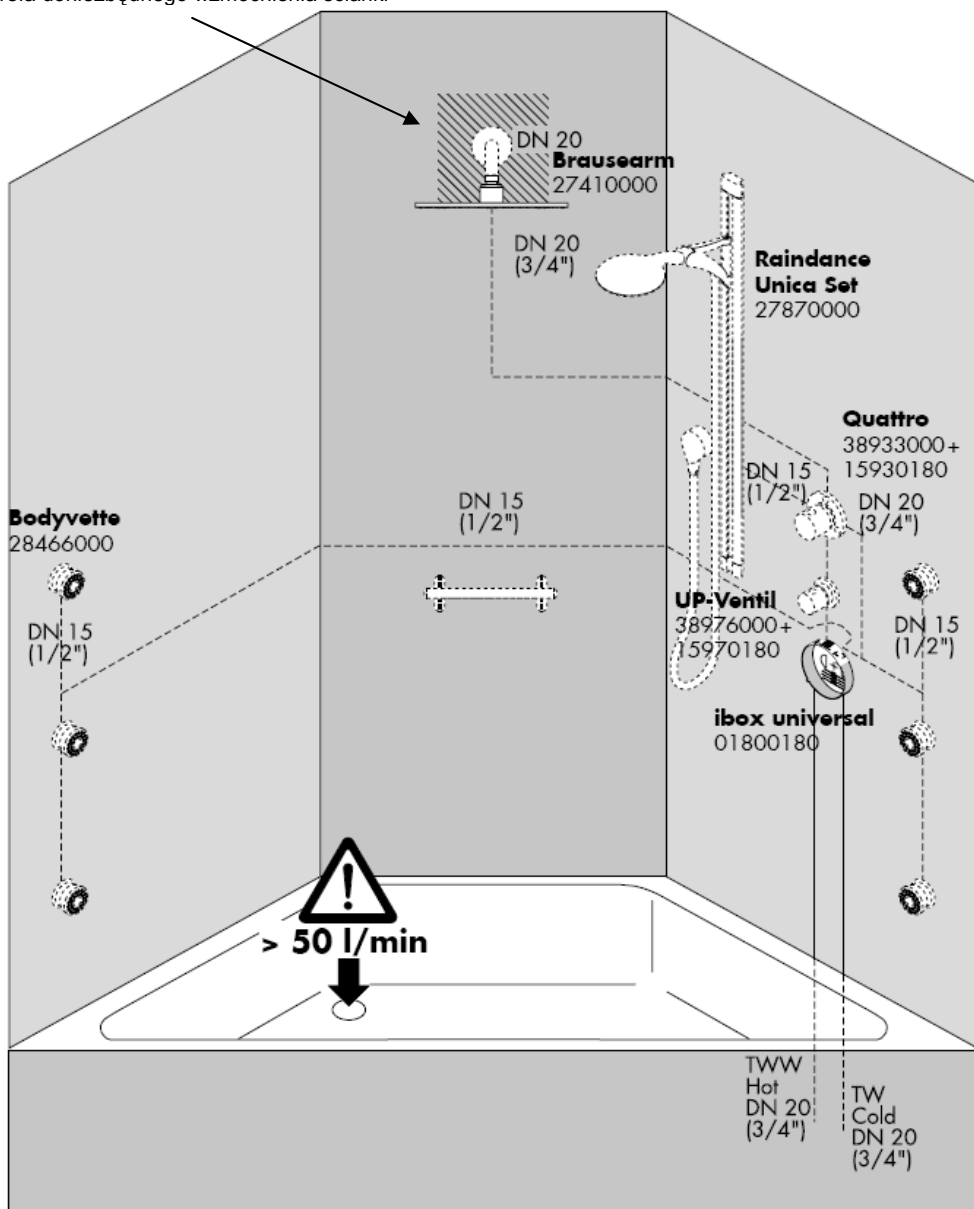

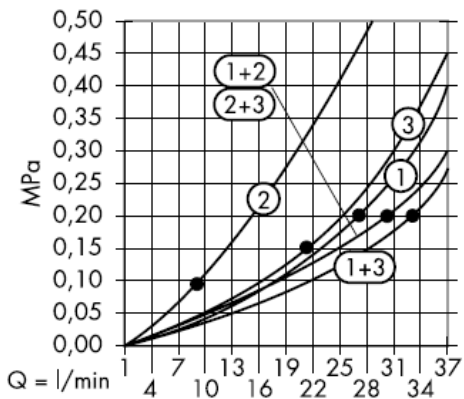

Od • możliwe jest funkcjonowanie.

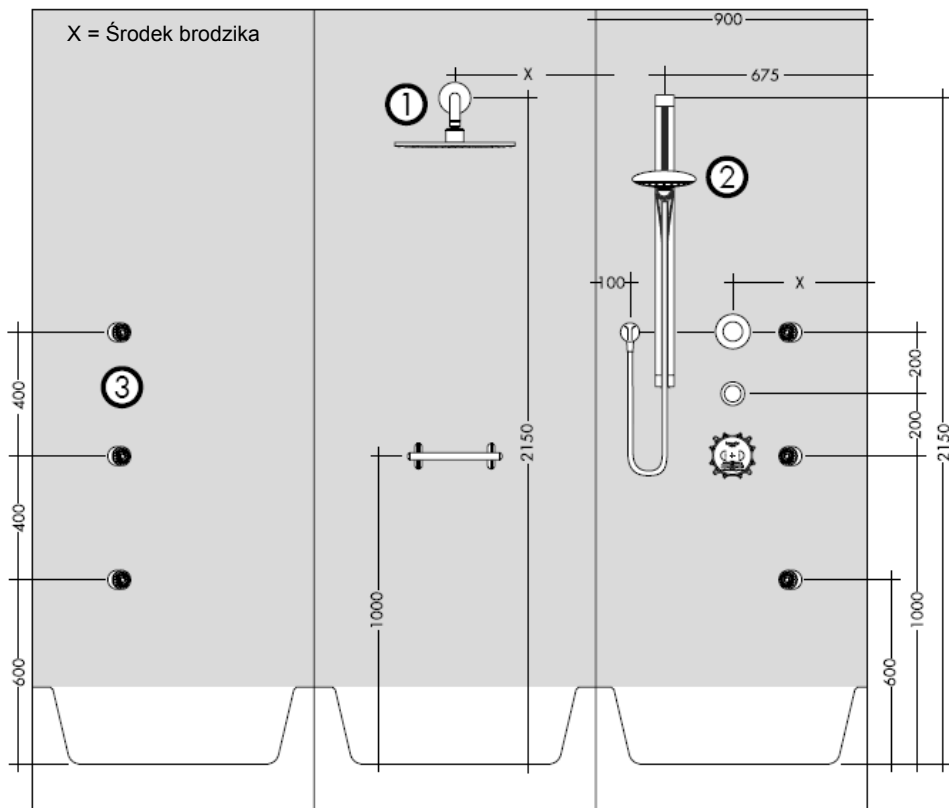

Strefa doniezbędnego wzmocnienia ścianki

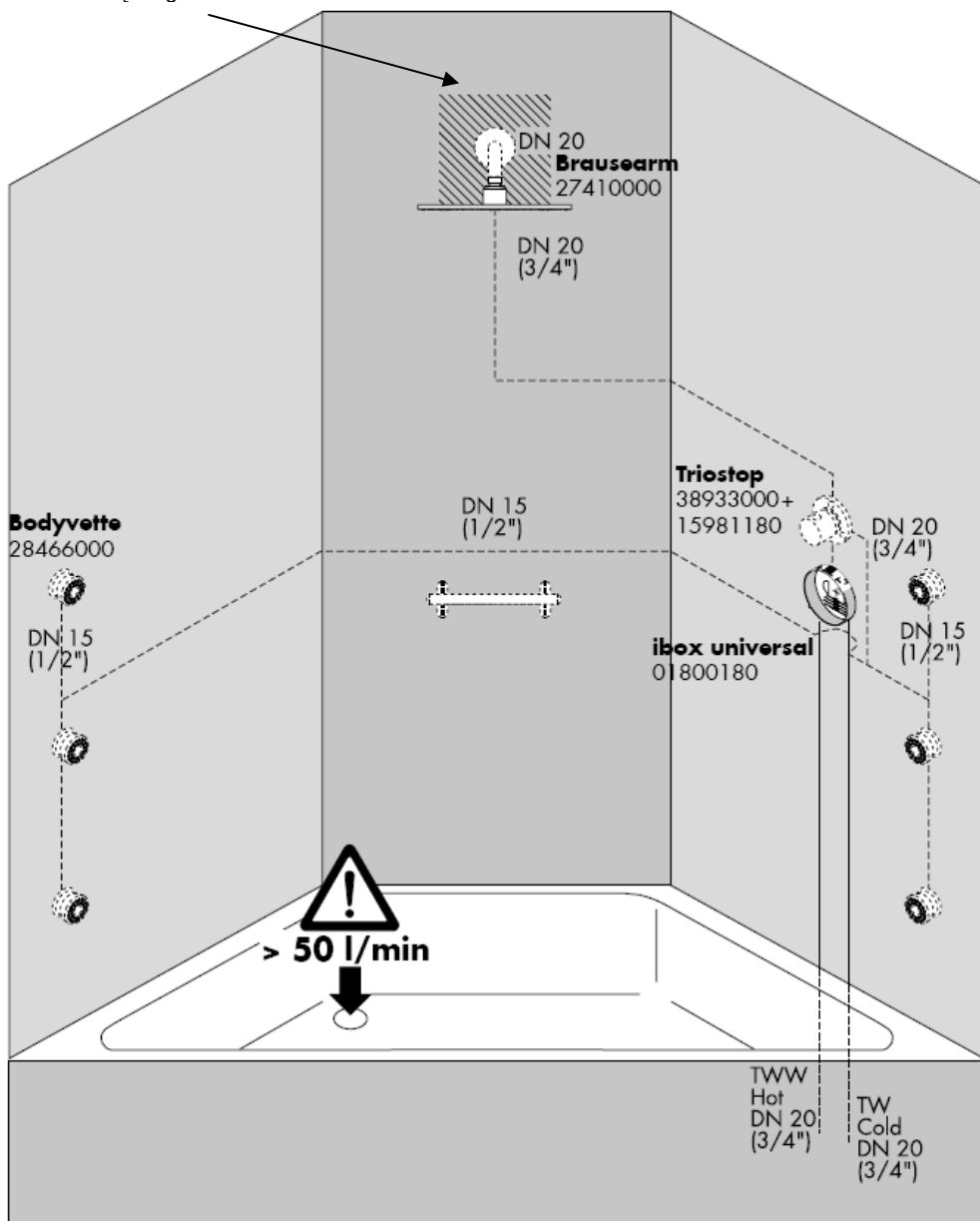

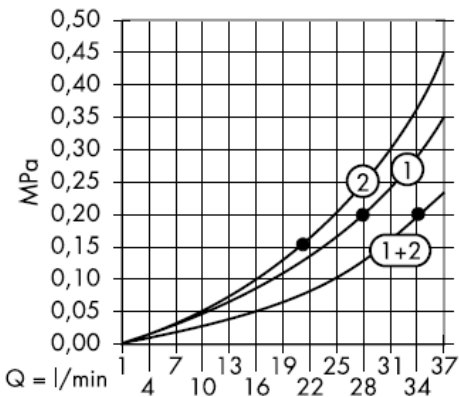

Od • możliwe jest funkcjonowanie.

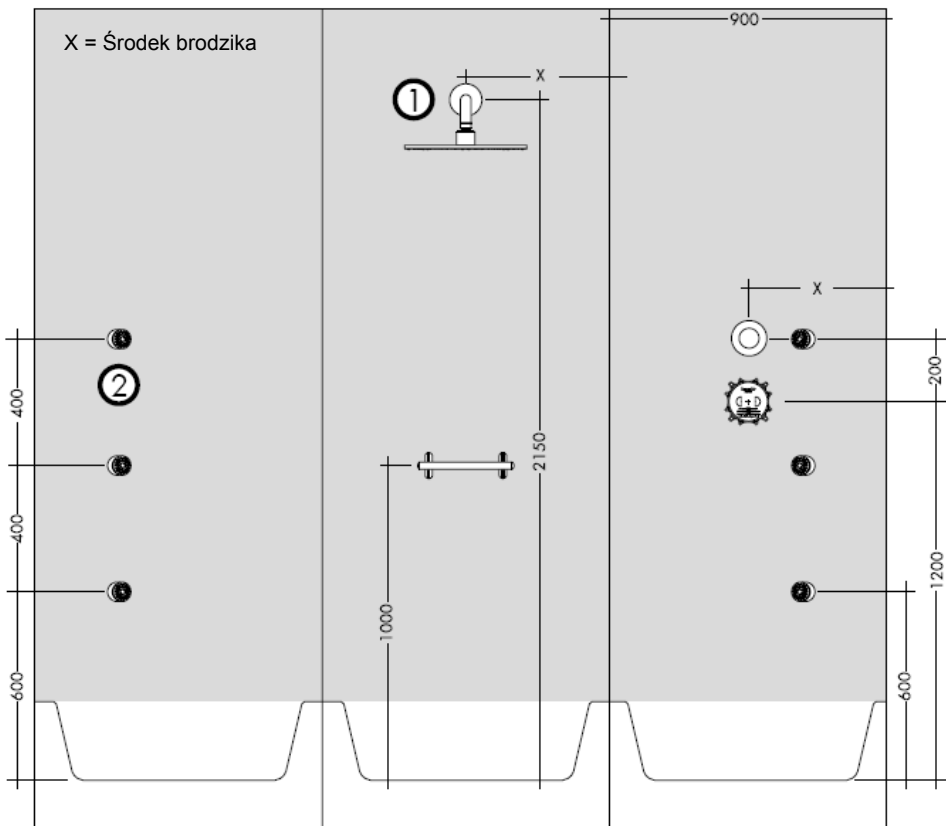

Strefa doniezbędnego wzmocnienia ścianki

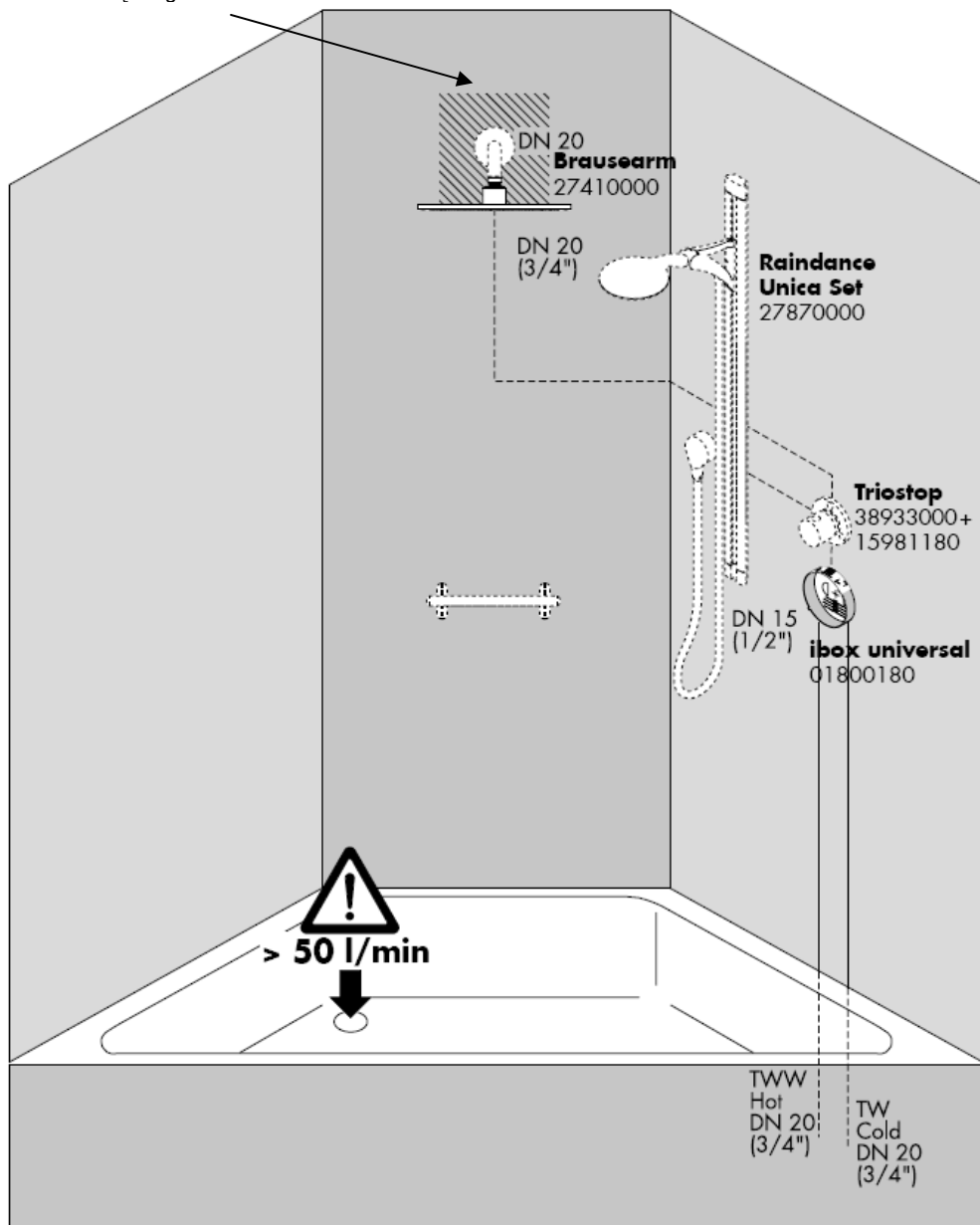

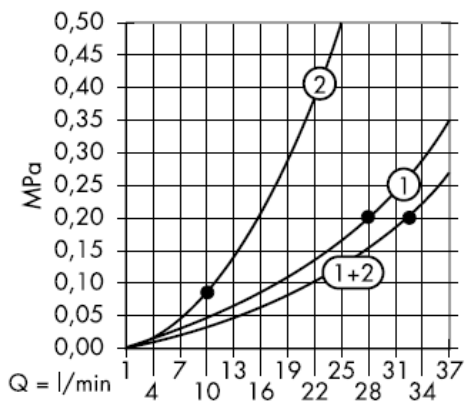

Od • możliwe jest funkcjonowanie.

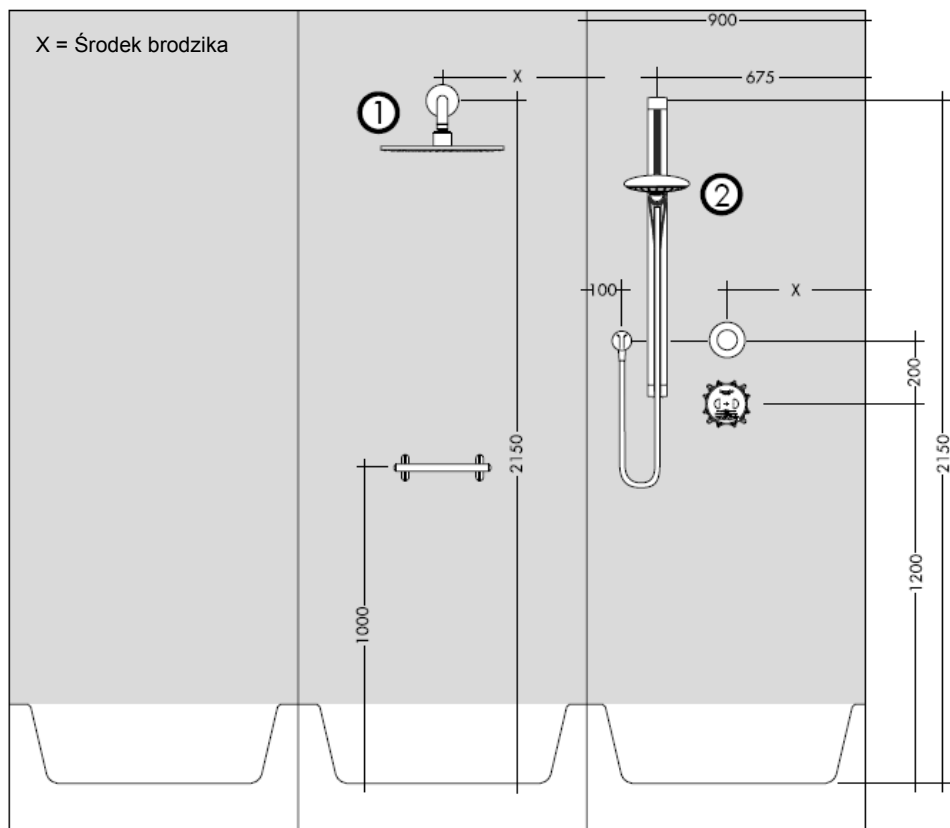

Strefa doniezbędnego wzmocnienia ścianki

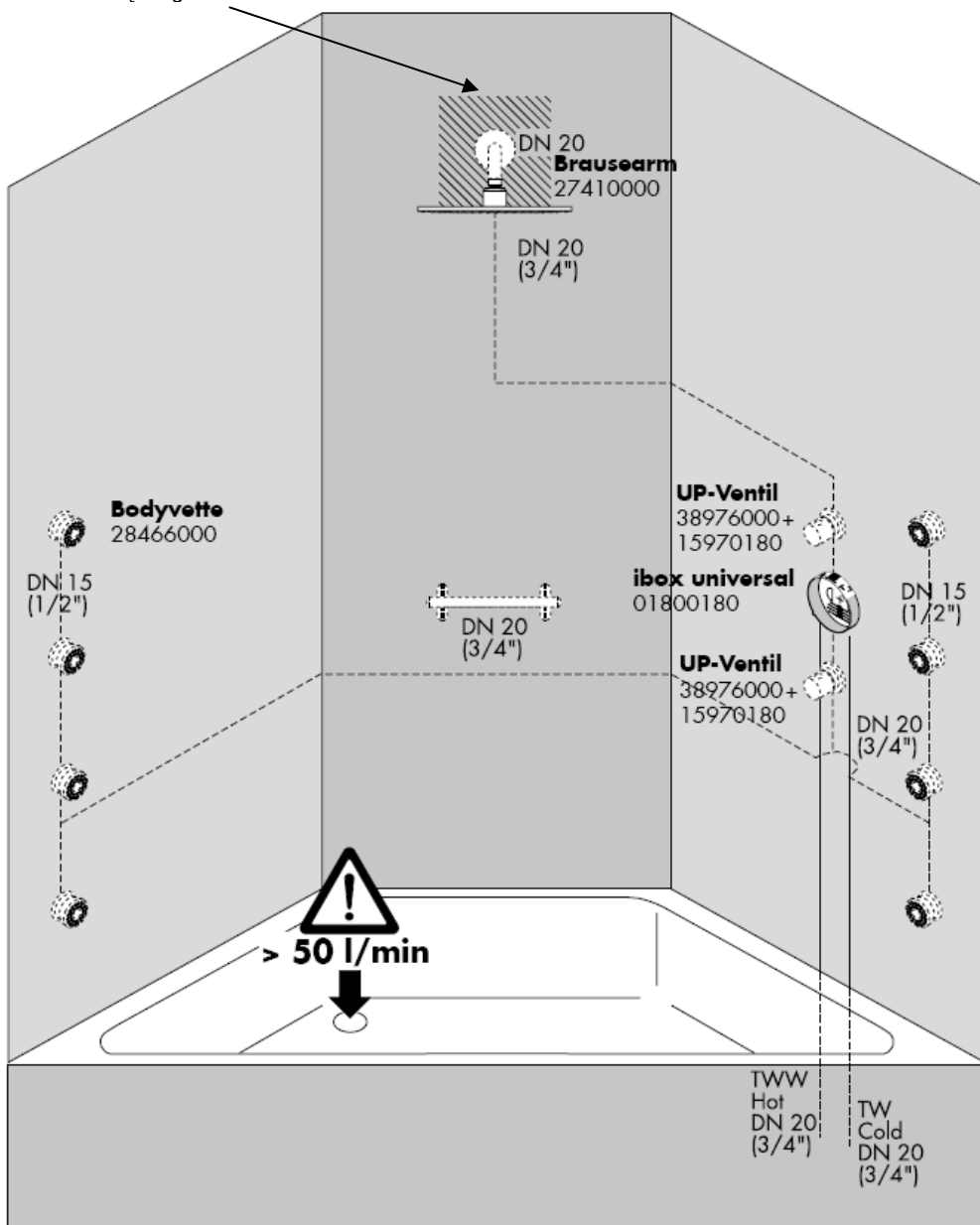

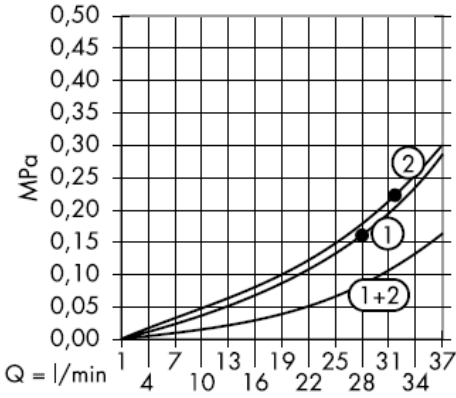

Od • możliwe jest funkcjonowanie.

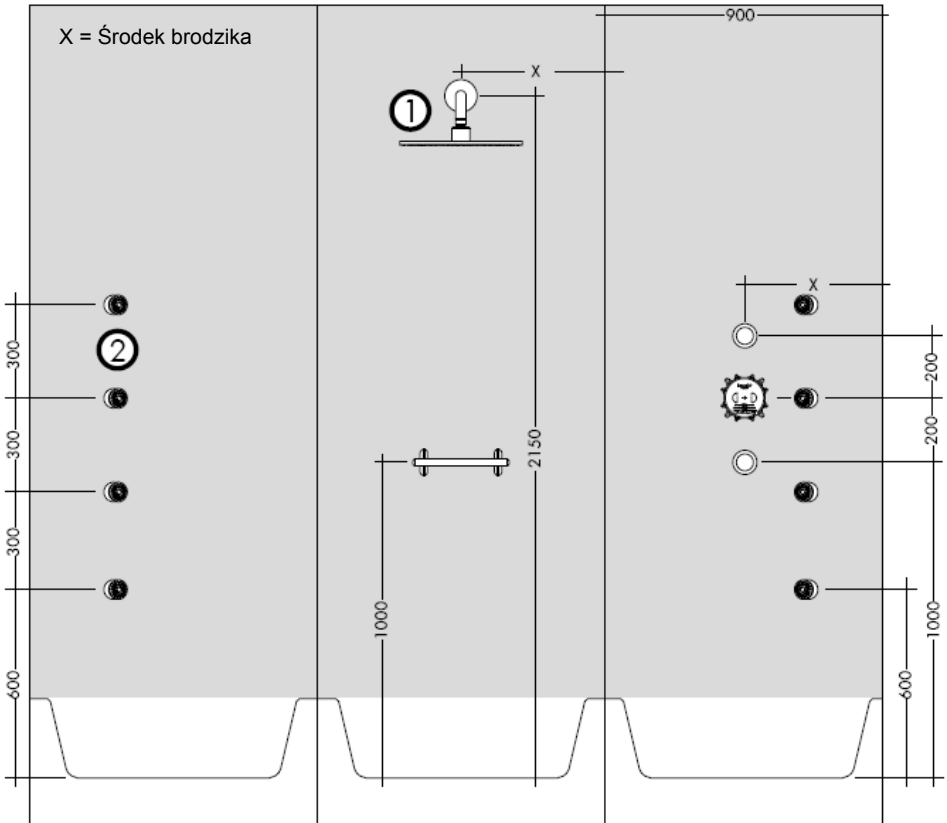

Strefa doniezbędnego wzmocnienia ścianki

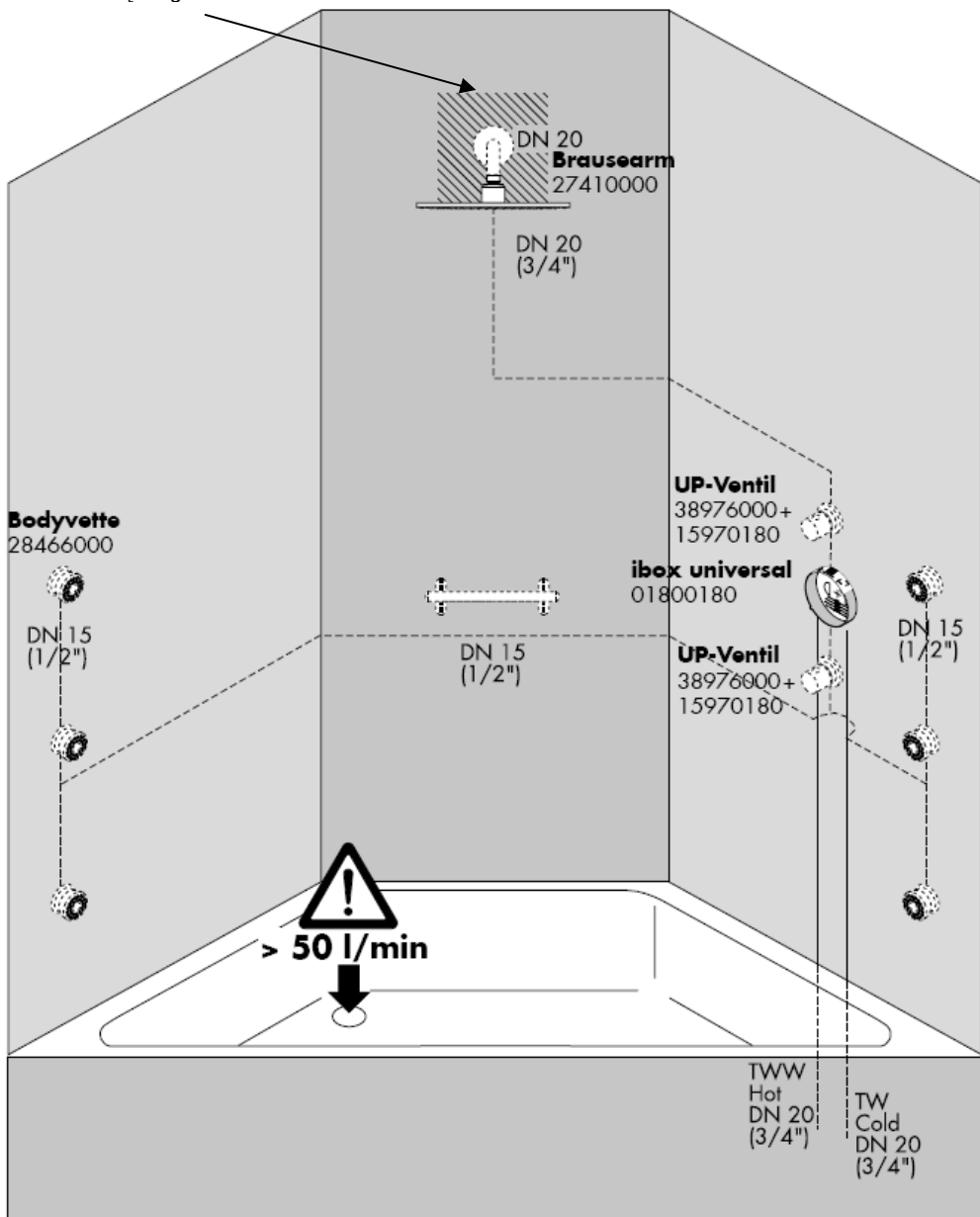

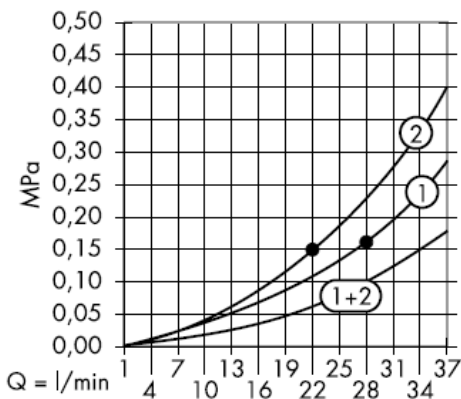

Od • możliwe jest funkcjonowanie.

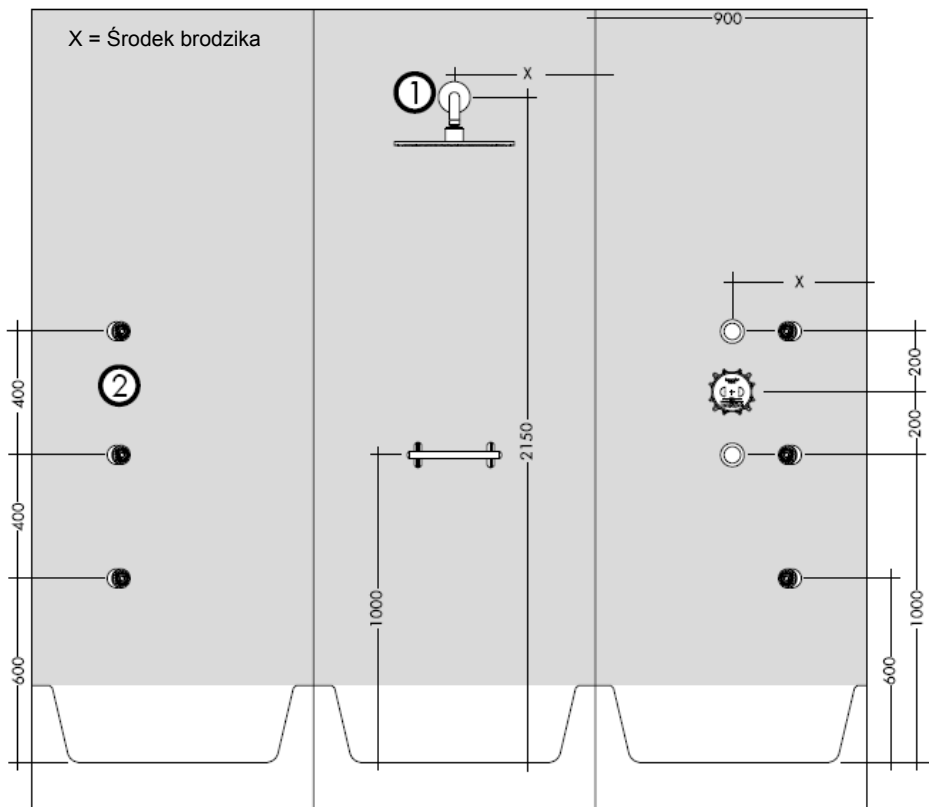

Strefa doniezbędnego wzmocnienia ścianki

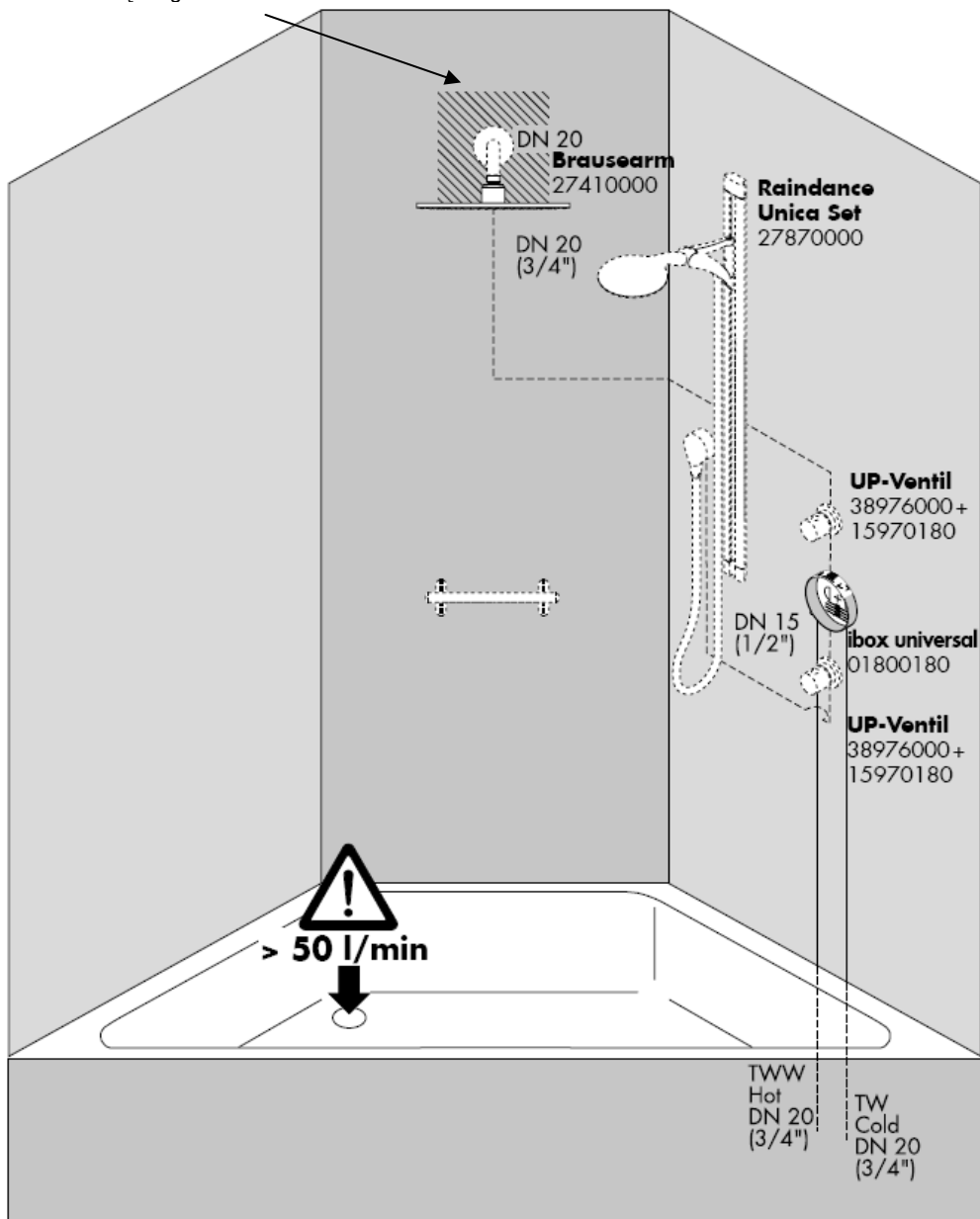

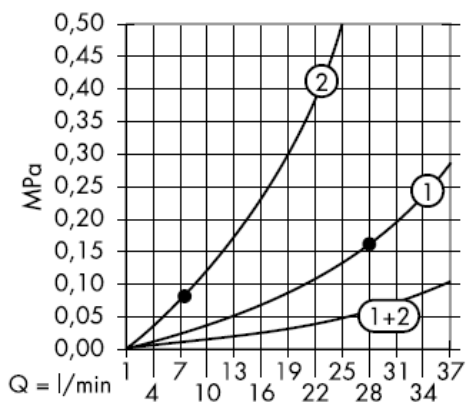

Od • możliwe jest funkcjonowanie.

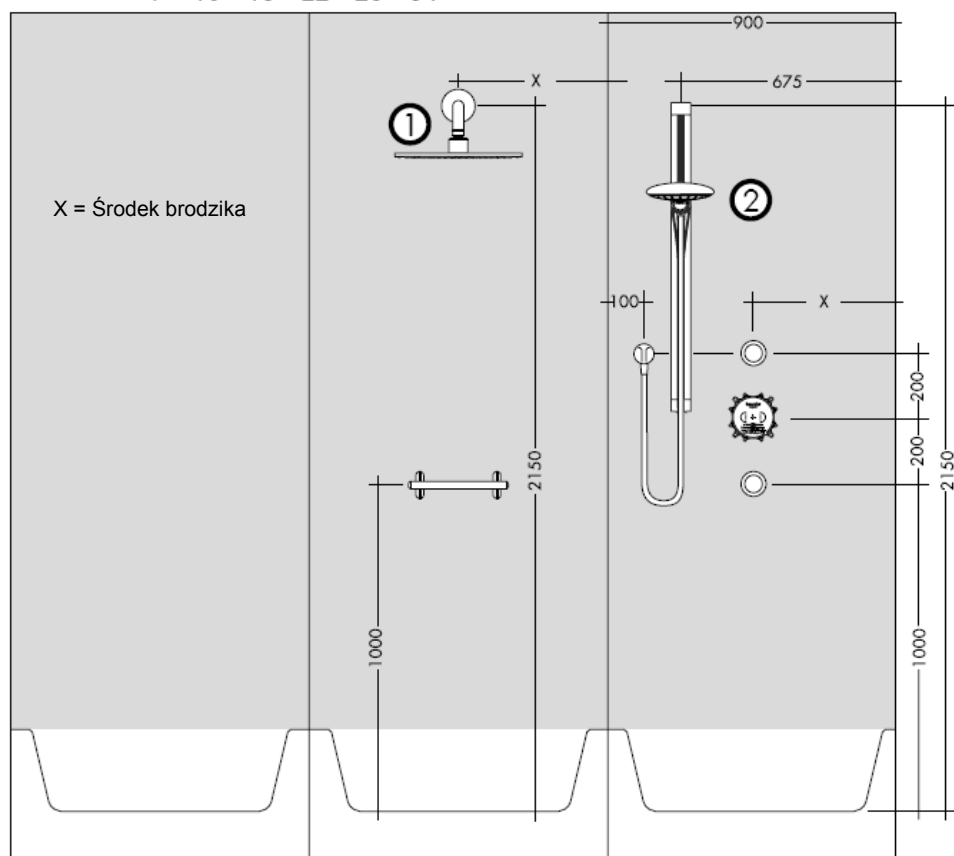

Strefa doniezbędnego wzmocnienia ścianki

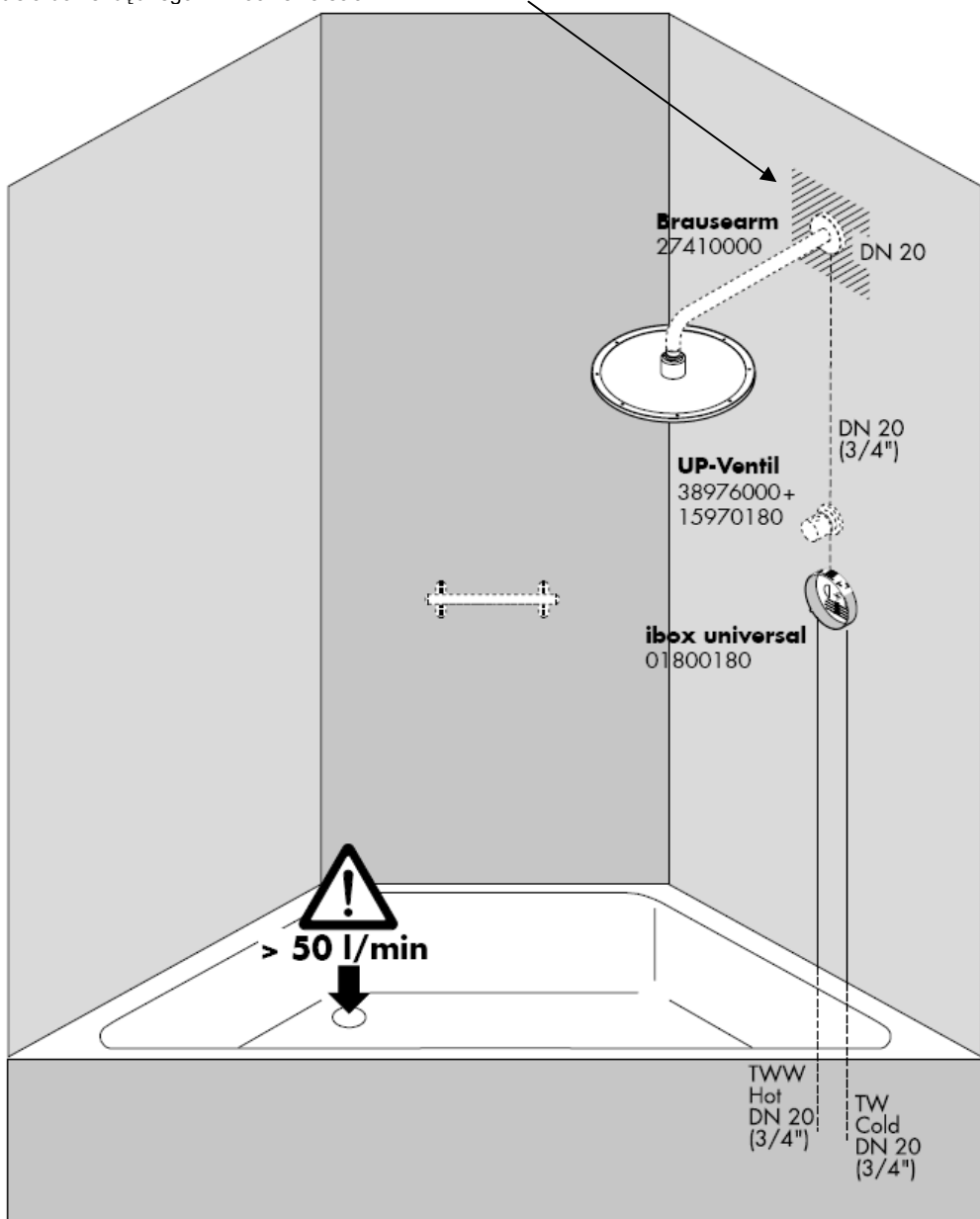

Od • możliwe jest funkcjonowanie.

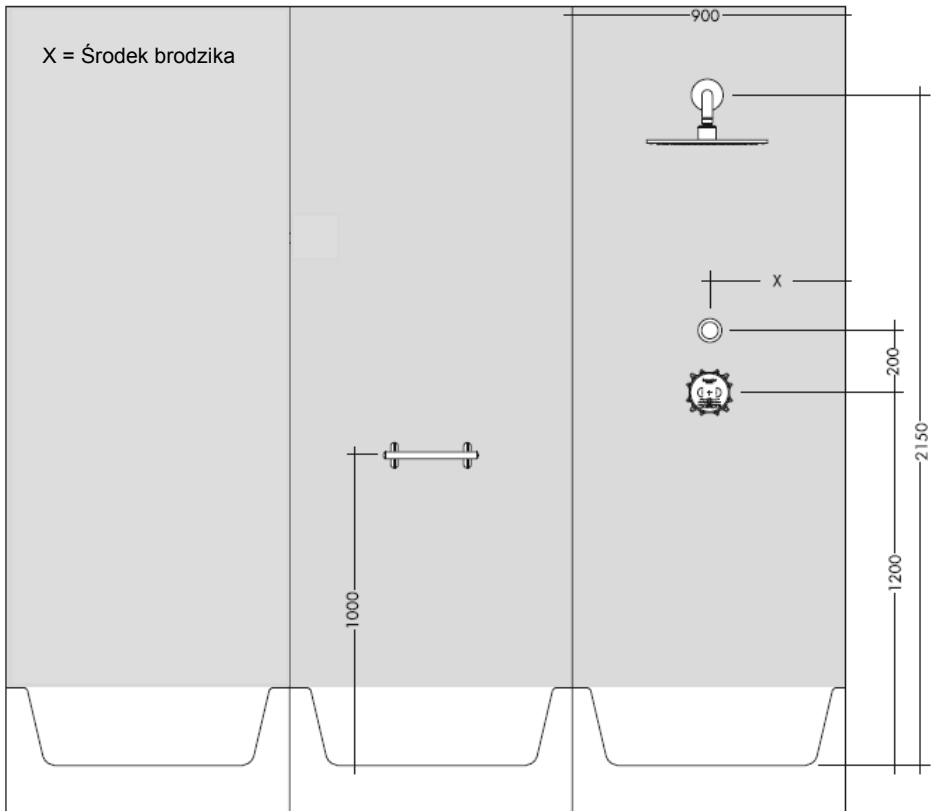
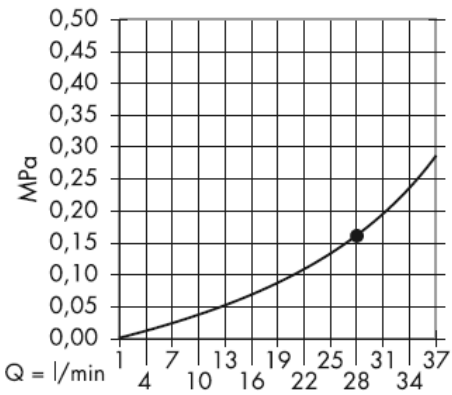

Strefa doniezbędnego wzmocnienia ścianki

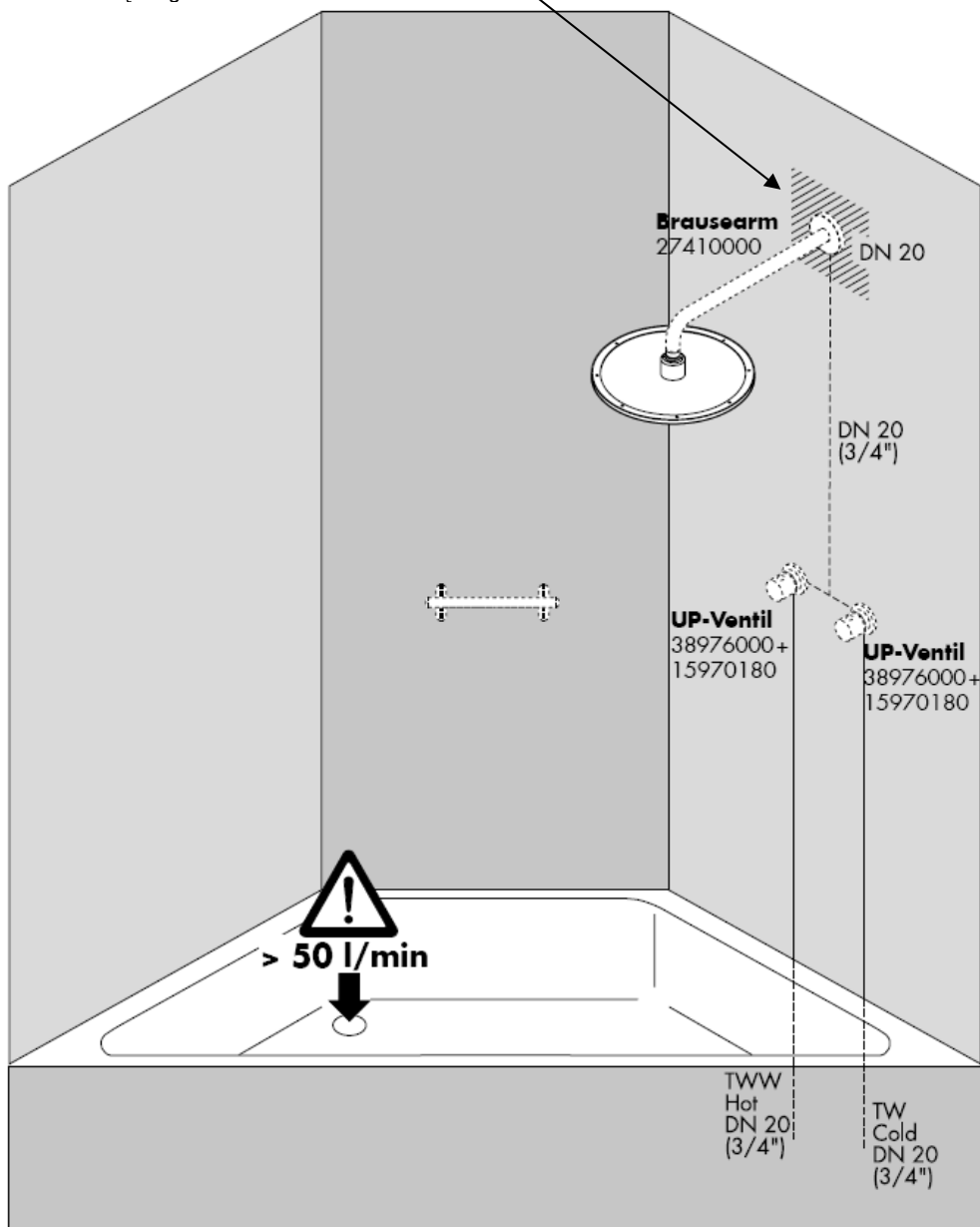

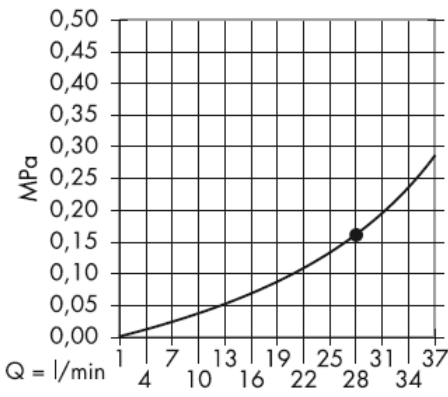

Od • możliwe jest funkcjonowanie.

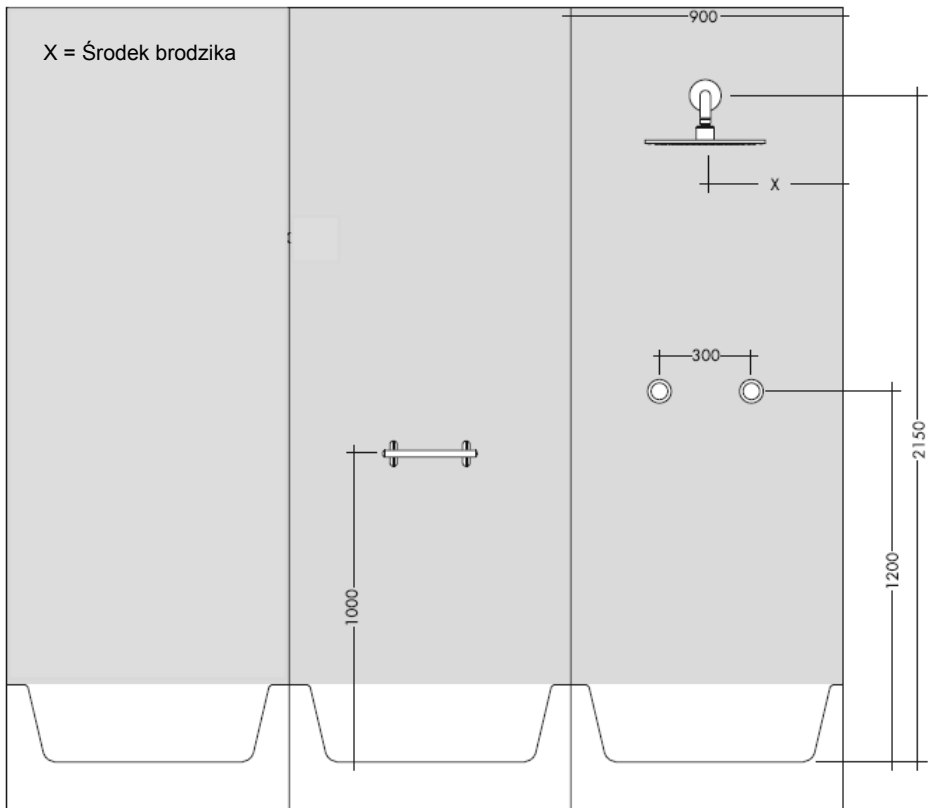

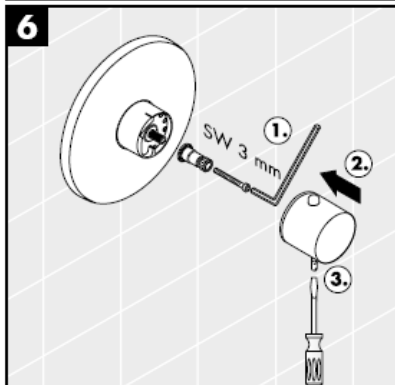
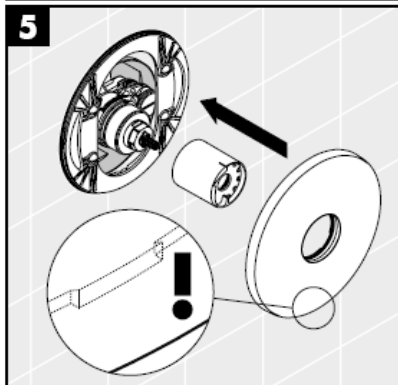
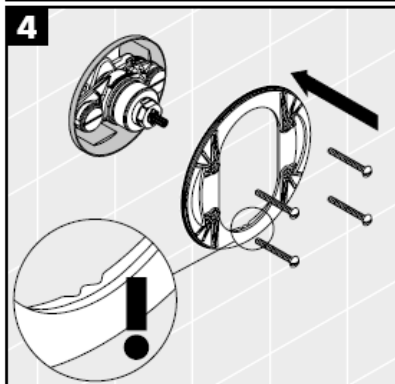
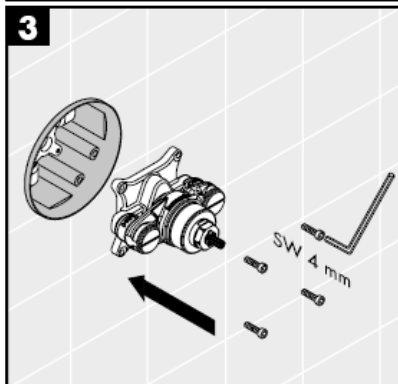
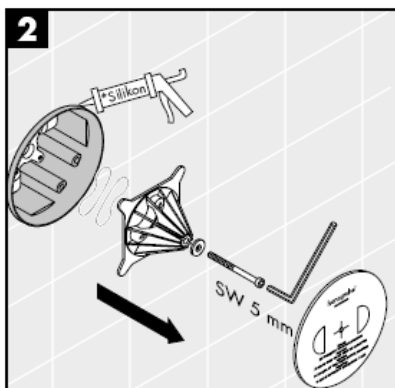
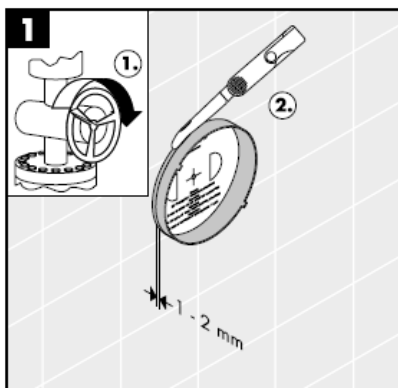

Silikon (neutralny)

Dzięki funkcji zabezpieczającej można przestawić żądaną maksymalną temperaturę np. na maks. 42 C.

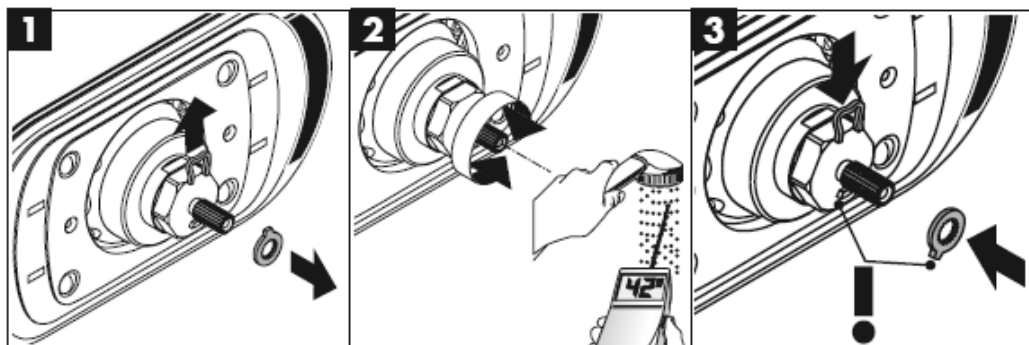

Regulacja

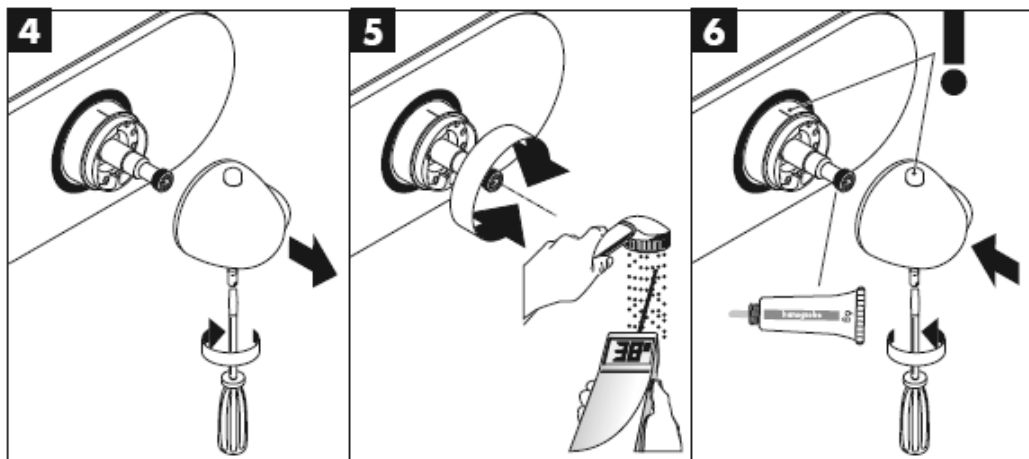



W czasie działania prysznica, waży on wraz z ramieniem prysznica ok. 10 kg. Z tego względu, w murze można użyć tylko odpowiedniego materiału mocującego! Umieszczone w dostawie śruby i kołki rozporowe są przeznaczone tylko do muru masywnego.

Należy stosować tylko elementy mocujące odpowiednie do muru! Dołączone śruby i kołki nadają się tylko do masywnego muru.

Odpływ musi mieć wystarczające wymiary.

Poprawność funkcjonowania gwarantowana tylko przy użyciu termostatów High Flow firmy Hansgrohe.

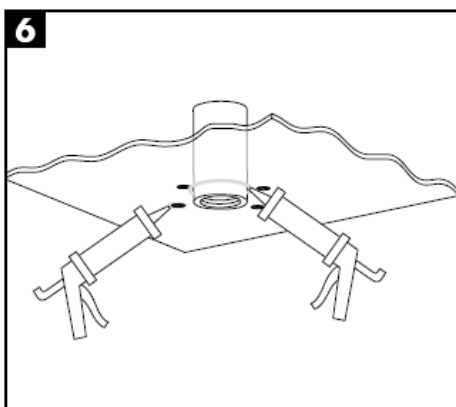
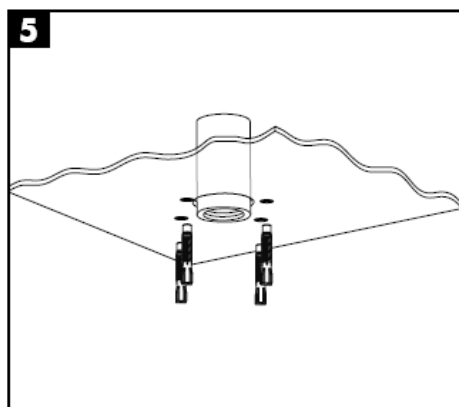
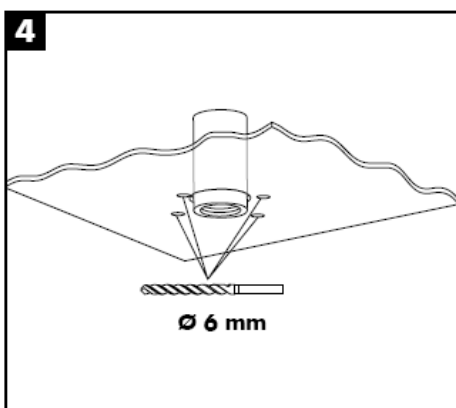
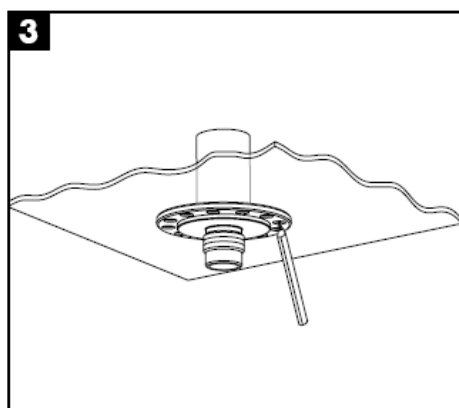
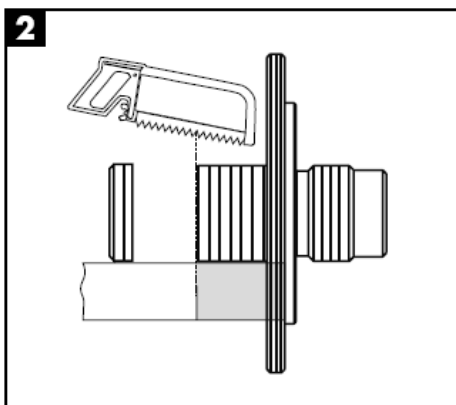
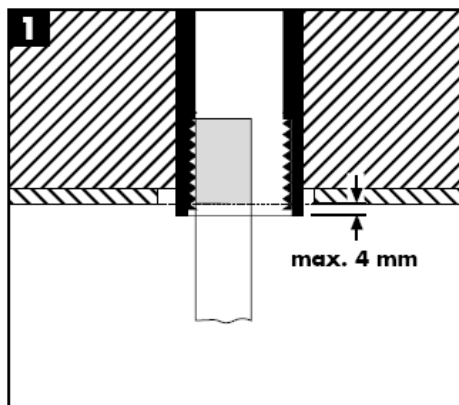

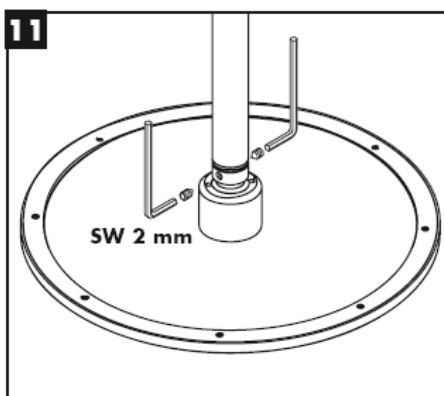
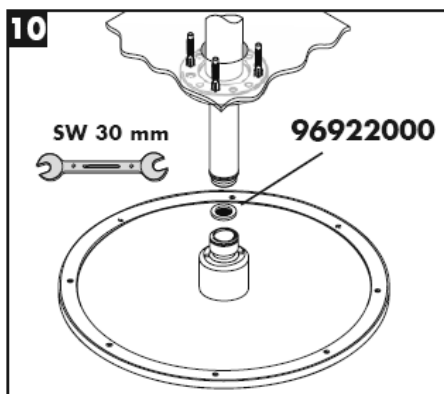
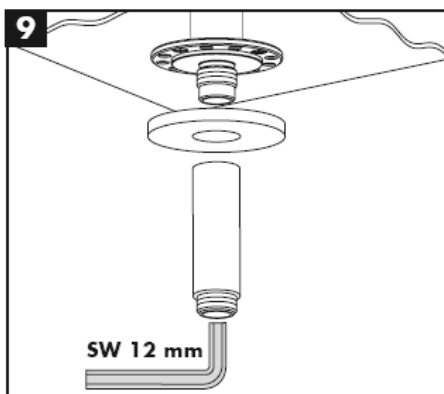
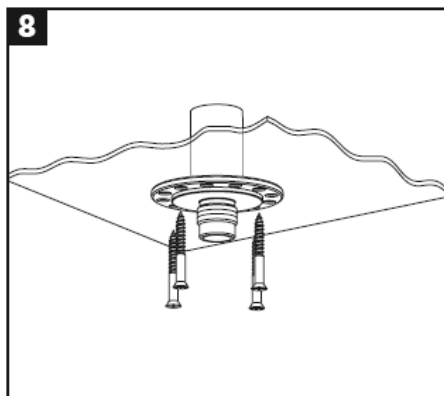
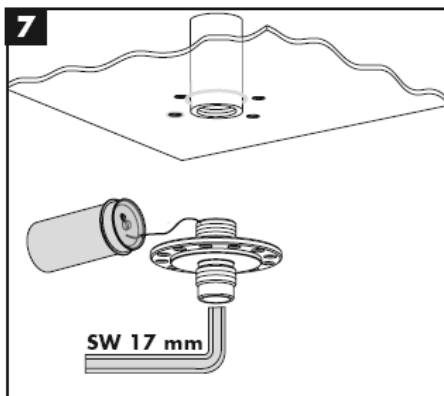

Znajdujące się przy prysznicu sitko musi zostać zainstalowane, aby zatrzymać zanieczyszczenia z instalacji. Przedostające się zanieczyszczenia mogą mieć ujemny wpływ na działanie i/lub prowadzić do usterek w działaniu elementów prysznic. Za powstałe z tego tytułu szkody firma Hansgrohe nie ponosi odpowiedzialności.

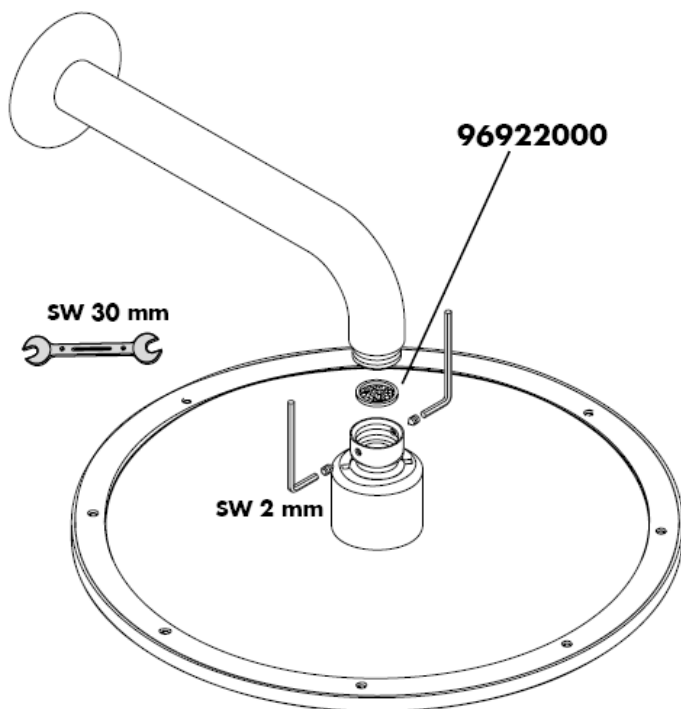

Montaż

Uwaga! Armatura musi być zamontowana, przepłukana i wypróbowana według obowiązujących norm!

Regulacja

Jeżeli po ustawieniu termostatu, temperatura na wylocie jest inna niż ustawiona, to wymagana jest korekta. Należy przy tym zwrócić uwagę na następujące kwestie:

Przekręcić pokrętkę z podziałką, aż na wylocie pojawi się woda o temperaturze 38 °C. Poluzować śrubę rączki, następnie śrubę tę ponownie dokręcić aż do pozycji 38 °C. Nałożyć rączkę i dokręcić śrubę rączki (patrz str. 22).

Ogranicznik temperatury

Zakres temperatury ogranicza się za pomocą blokady zabezpieczającej do 38 °C (ochrona przed poparzeniem).

Jeżeli pożądana jest wyższa temperatura, wówczas można przekroczyć blokadę 38 °C przez naciśnięcie przycisku zabezpieczającego.

Safety Function

Dzięki funkcji zabezpieczającej można przestawić żądaną maksymalną temperaturę np. na maks. 42 °C. patrz strona 21.

Dane techniczne

Ciśnienie robocze: max. 1 MPa
 Zalecane ciśnienie robocze: 0,1 – 0,5 MPa
 Ciśnienie próbne: 1,6 MPa
 (1 MPa = 10 bary = 147 PSI)
 Temperatura wody gorącej: max. 80 °C
 Zalecana temperatura wody gorącej: 65 °C
 Wydajność przepływu: ca. 58 l/min 0,3 MPa

Konserwacja

Termostaty nie wymagają szczególnej konserwacji. Działanie zabezpieczeń przed przepływem zwrotnym, zgodnie z normą DIN EN 1717 i miejscowymi przepisami, musi być kontrolowane (DIN 1988, raz w roku). Przy okazji należy także sprawdzić łapacze zanieczyszczeń, które znajdują się na termostacie MTC (6.1) Po montażu termostatu MTC (6) należy koniecznie sprawdzić temperaturę wypływającej wody w sposób opisany w punkcie "Regulacja". Przedtem należy koniecznie sprawdzić czy włączone jest zasilanie ciepłej wody i czy w miejscu poboru jest maks. temperatura ciepłej wody.

Aby zachować łatwość obsługi termostatu, od czasu do czasu należy go przekręcić na całkiem zimną i na całkiem ciepłą wodę.

Części serwisowe patrz strona 3

1	Uchwyt termostatu	38391000
2	Rozeta	96452000
3	Tuleja	97439000
4	Śruby rozety nośnej	96454000
5	Rozeta nośna	96447000
6	Wkład termostatyczny	96633000
7	Sitko	97367000
8	Zabezpieczenie przed przepływem zwrotnym	96655000
9	Przedłużacz 25 mm	13595000
10	Przedłużacz 25 mm	13596000

Polski

Usterka	Przyczyna	Pomoc
Mała ilość wody	-Zbyt niskie ciśnienie zasilające -Zabrudzone sitko przy wkładzie termostatycznym -Zabrudzona uszczelka z sitkiem w prysznicu	-Sprawdzić ciśnienie w instalacji -Wyczyścić sitka -Oczyścić uszczelkę z sitkiem pomiędzy prysznicem a węzłem
Przepływ krzyżowy, woda ciepła przy zamkniętej armaturze wpływa do przewodu wody zimnej lub odwrotnie	-Zabrudzone / uszkodzone zabezpieczenie przed przepływem zwrotnym	-Wymienić zabezpieczenie przed przepływem zwrotnym
Temperatura wody nie zgadza się z ustawioną wartością	-Termostat nie został wyregulowany -Za niska temperatura ciepłej wody	-Przeprowadzić regulację termostatu -Podwyższyć temperaturę wody ciepłej na 42 C do 65 C
Brak możliwości regulacji temperatury	-Zabrudzony lub zakamieniony termostat -Blok funkcyjny obrócić o 180	-Przy nowej instalacji niewłaściwie podłączony korpus (powinno być: zimna po prawej, ciepła po lewej) albo zamontowano z przekręceniem o 180 . -Złe funkcjonowanie przycisku zabezpieczającego
Uszkodzona sprężynka	-Wyczyścić wzgl. wymienić sprężynkę lub przycisk i lekko nasmarować -przycisk zakamieniony	-Wyczyścić wzgl. wymienić sprężynkę lub przycisk i lekko nasmarować -Wyczyścić wzgl. wymienić sprężynkę lub przycisk i lekko nasmarować

Znak jakości

	P-IX	DVGW	SVGW	WRSA	KIWA	ACS	NF
27070000						X	
27418XXX							
28420000						X	
28435XXX						X	

Czyszczenie

Po prostu czysto: Pęczki można całkiem łatwo oczyścić z kamienia.

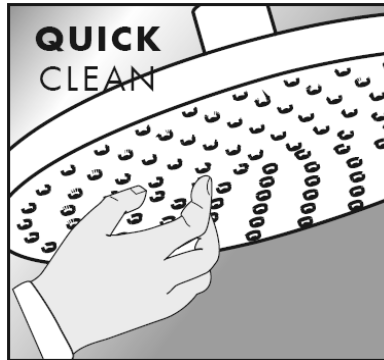

Instrukcja pielęgnacji

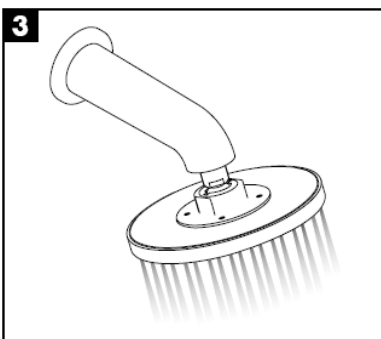
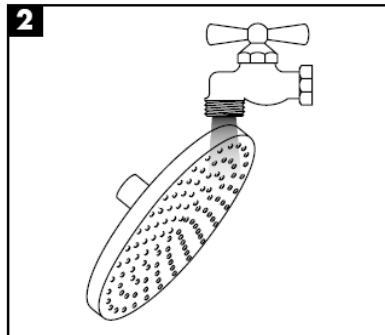
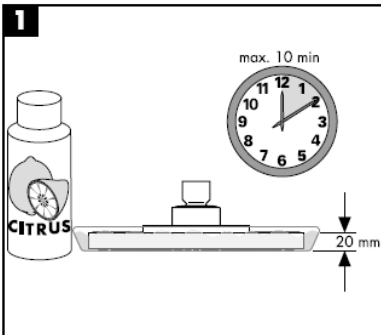

hansgrohe

Montážní návod



27418XXX

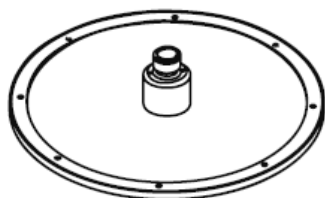

Raindance Royale AIR
28420000

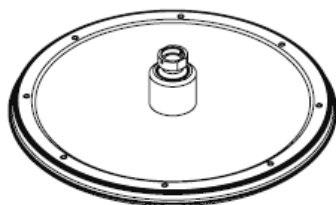

Raindance Royale Classic AIR
28435XXX

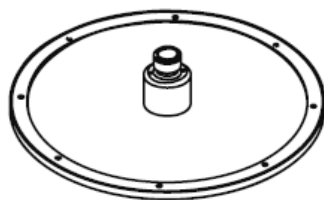

**Raindance Royale
High Flow Set**
27070000

hansgrohe

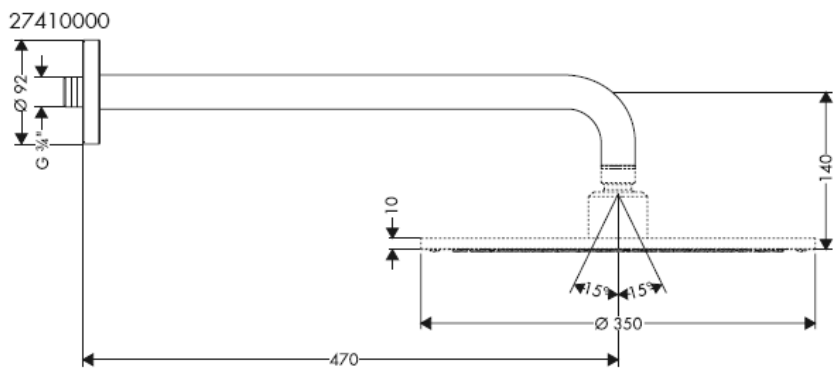
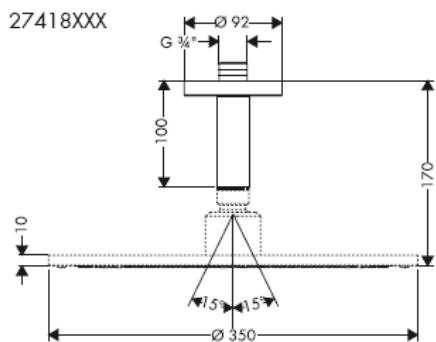
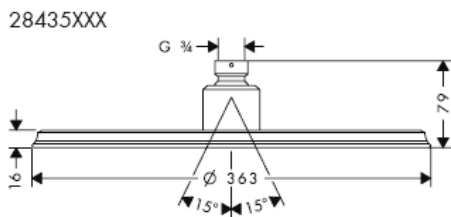
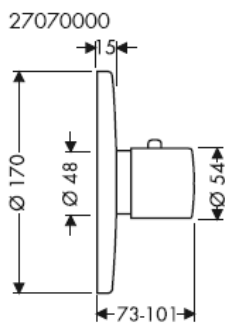
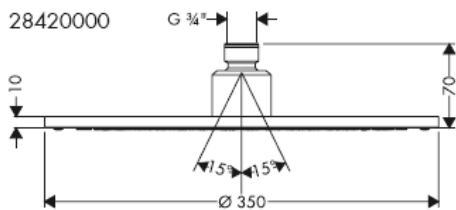

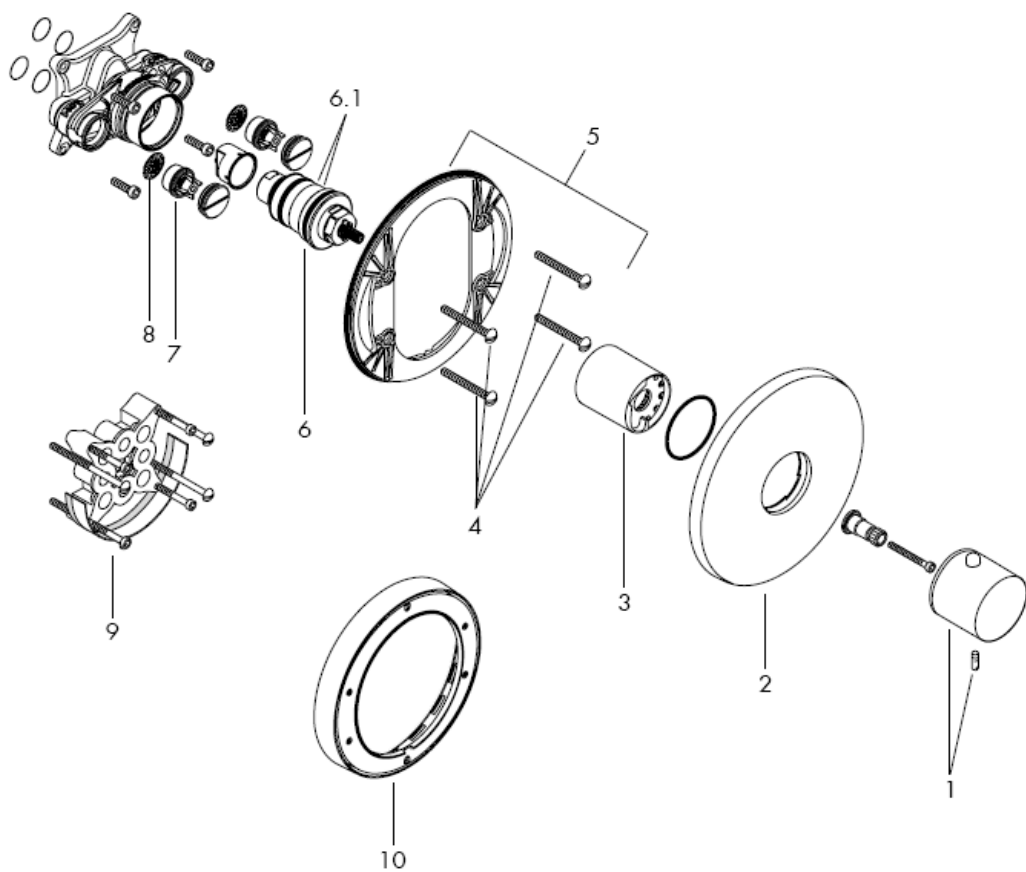

Rozměry pokud možno přizpůsobit rozložení obkladů.

Oblast potřebnévyztužení zdi

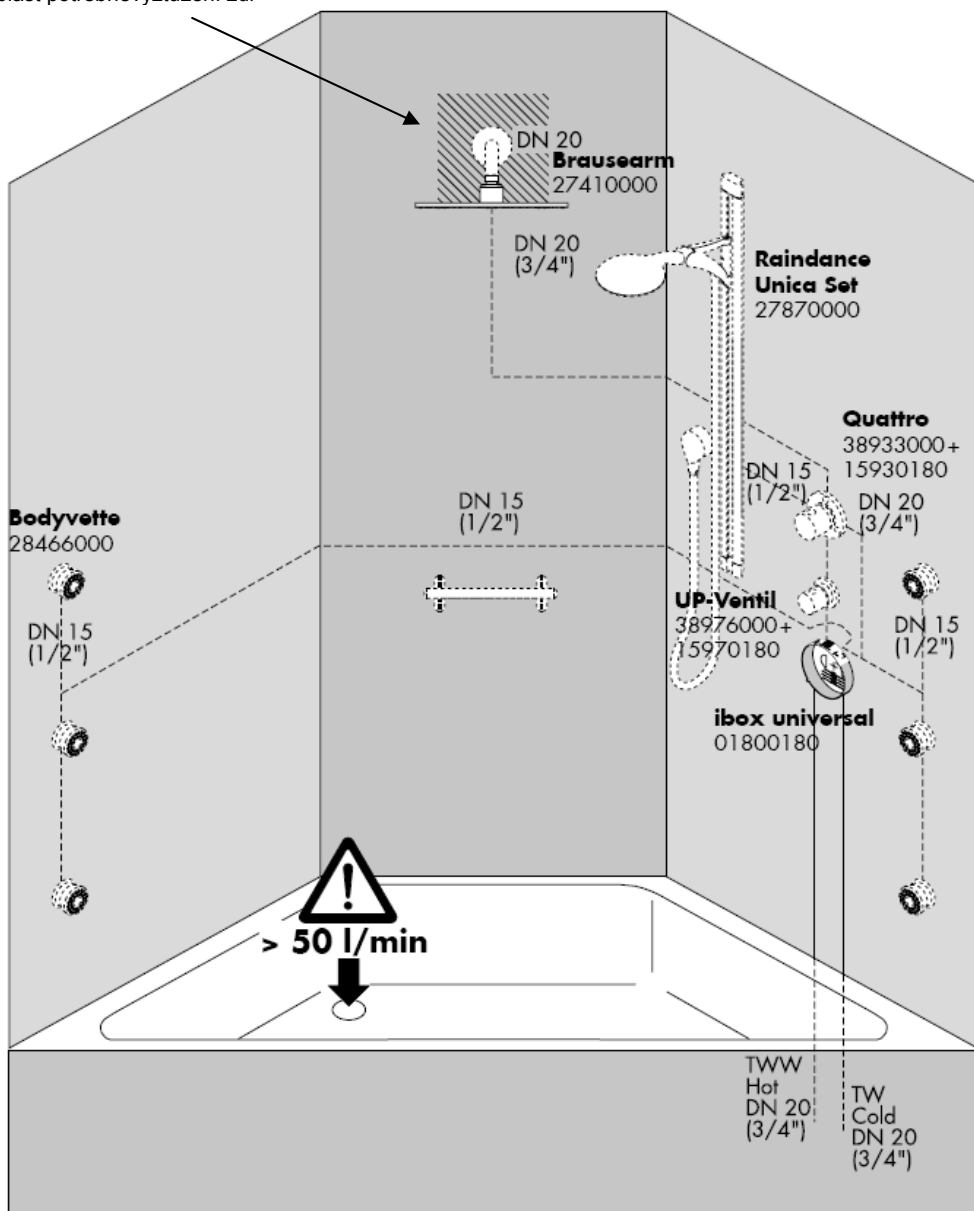

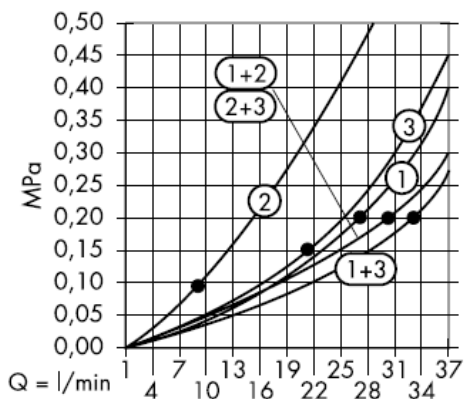

Od • je zaručená funkce

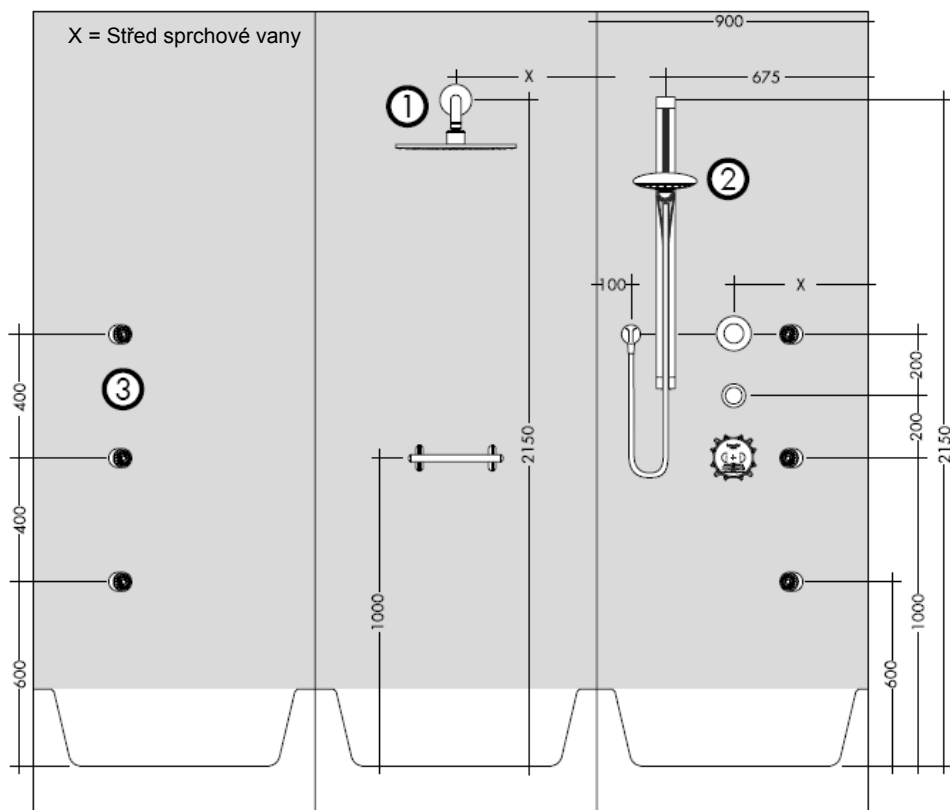

Oblast potřebnévyztužení zdi

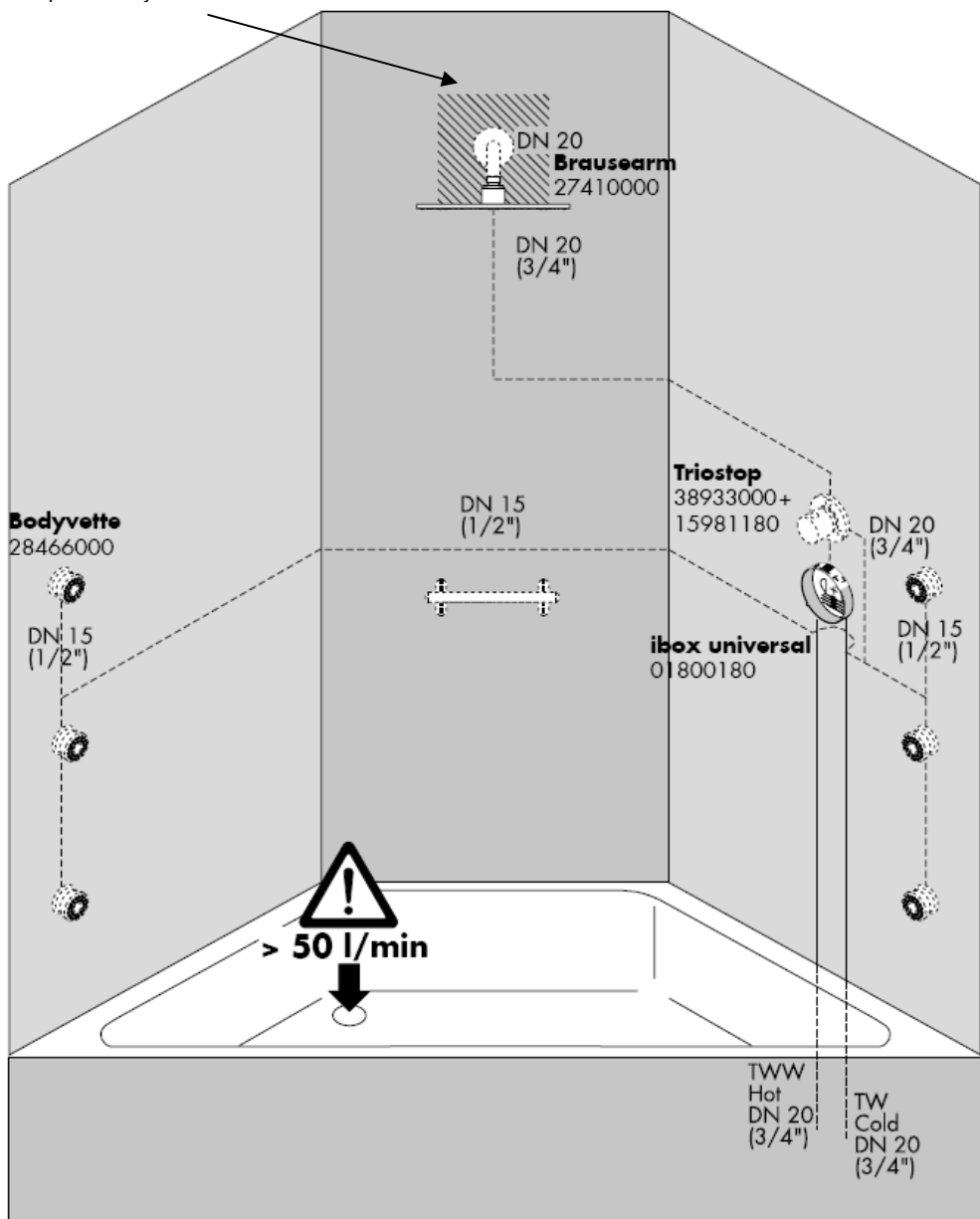

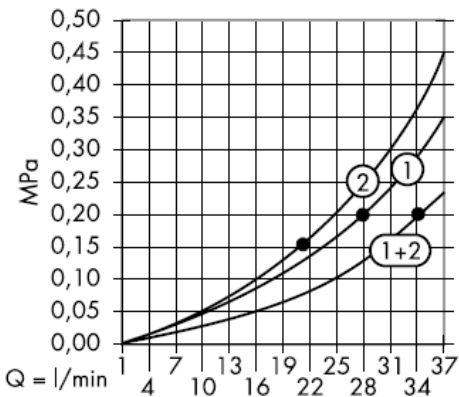

Od • je zaručená funkce

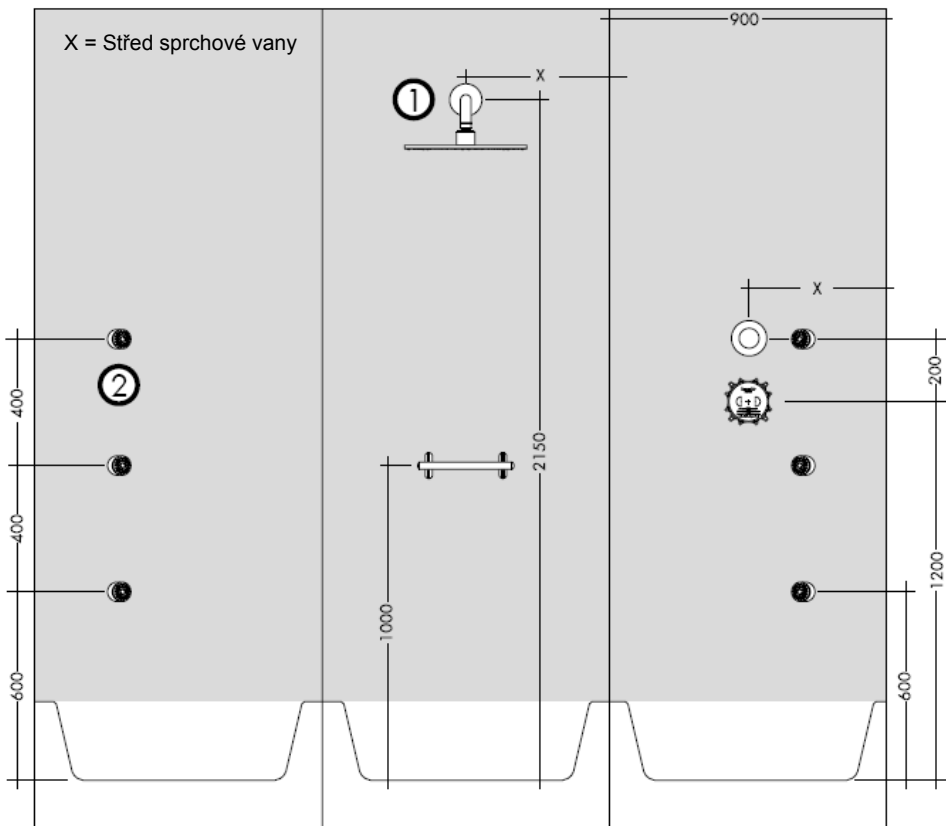

Oblast potřebnévyztužení zdi

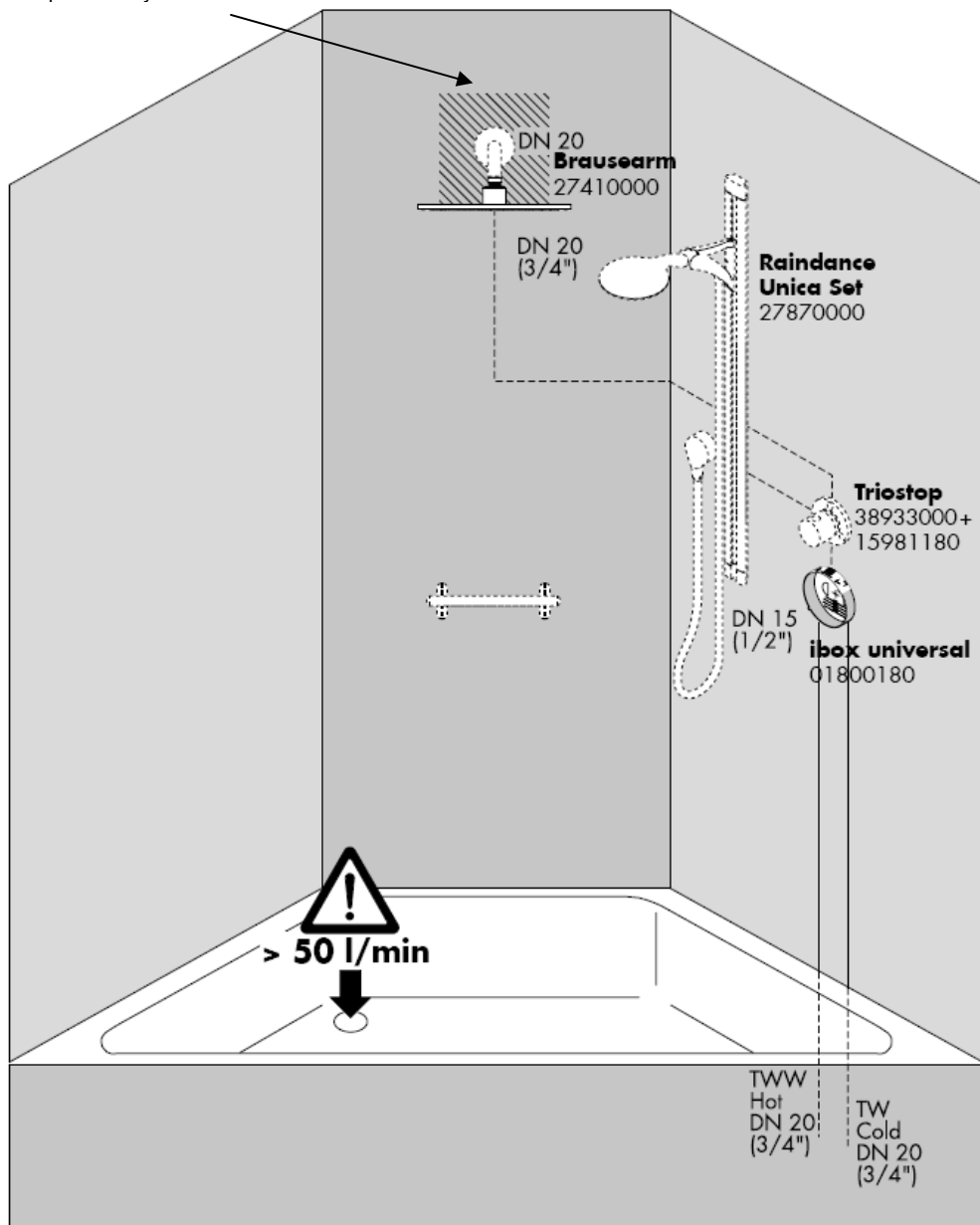

Oblast potřebnévyztužení zdi

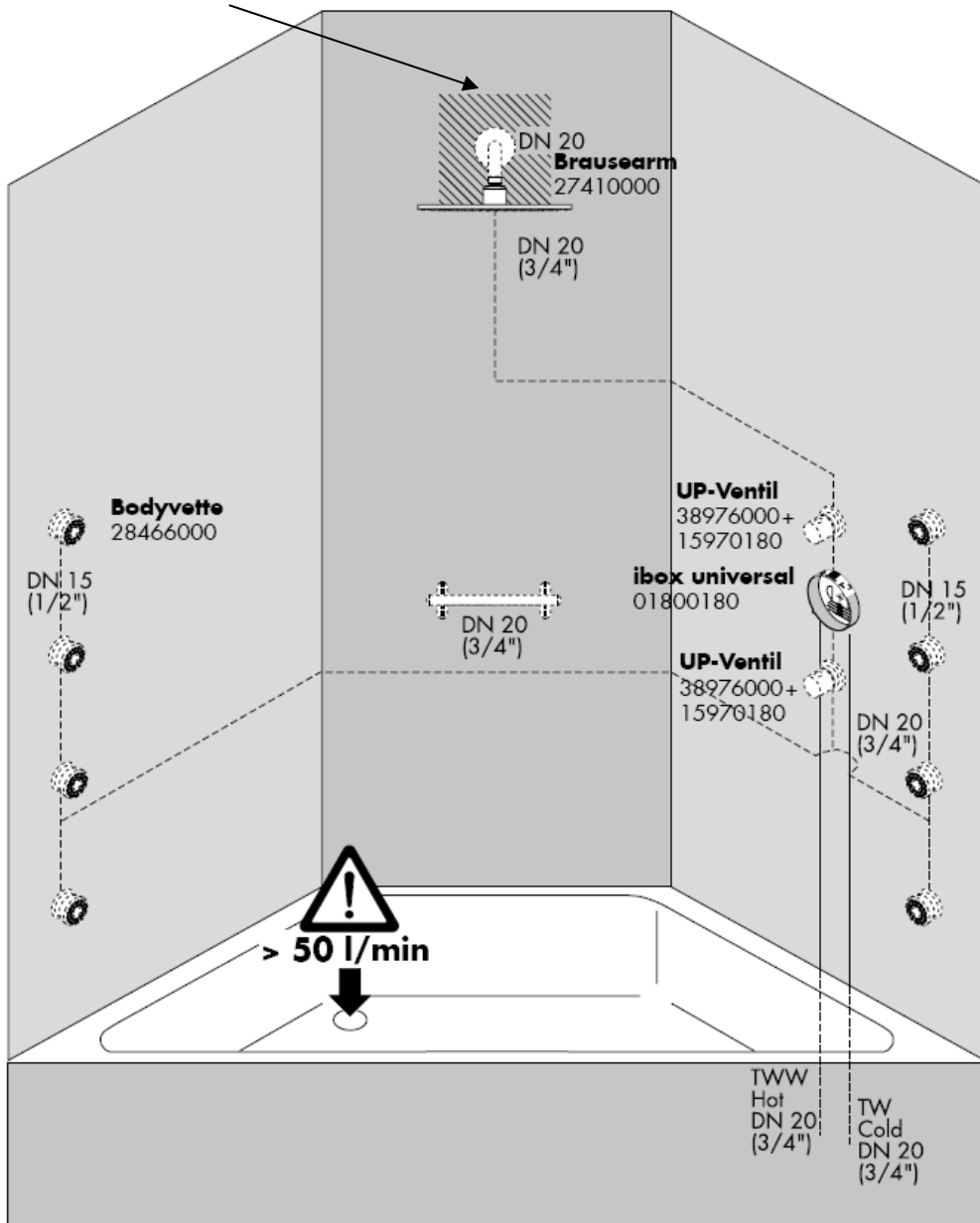

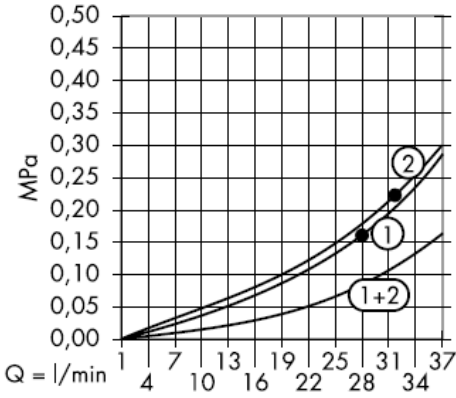

Od • je zaručená funkce

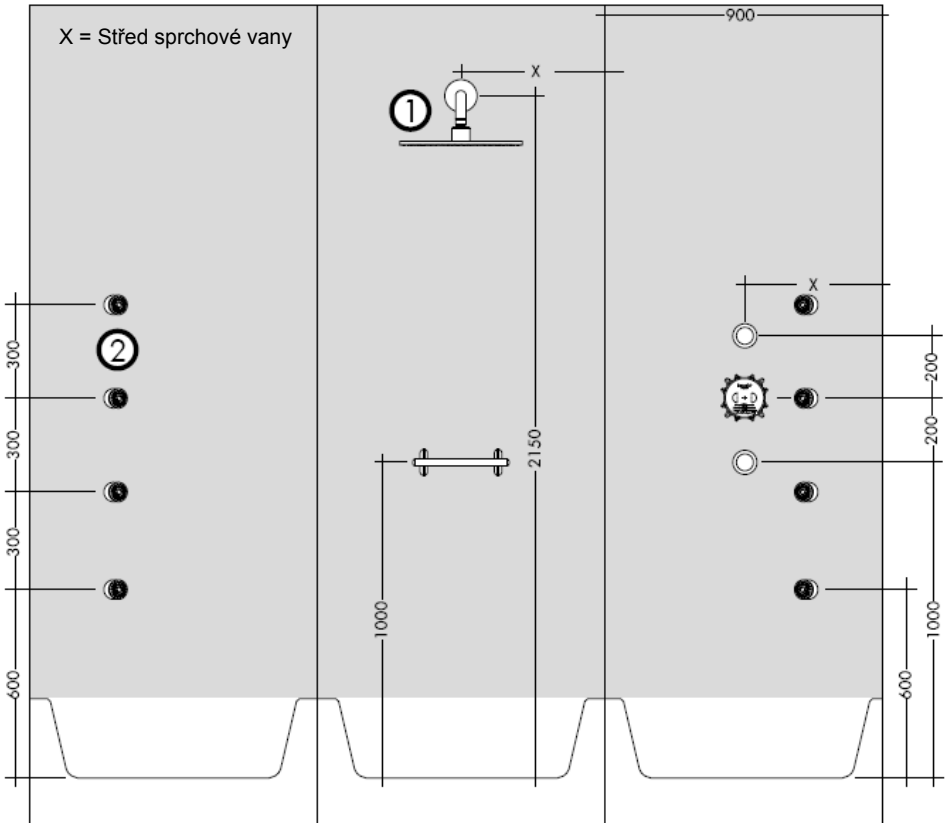

Oblast potřebnévyztužení zdi

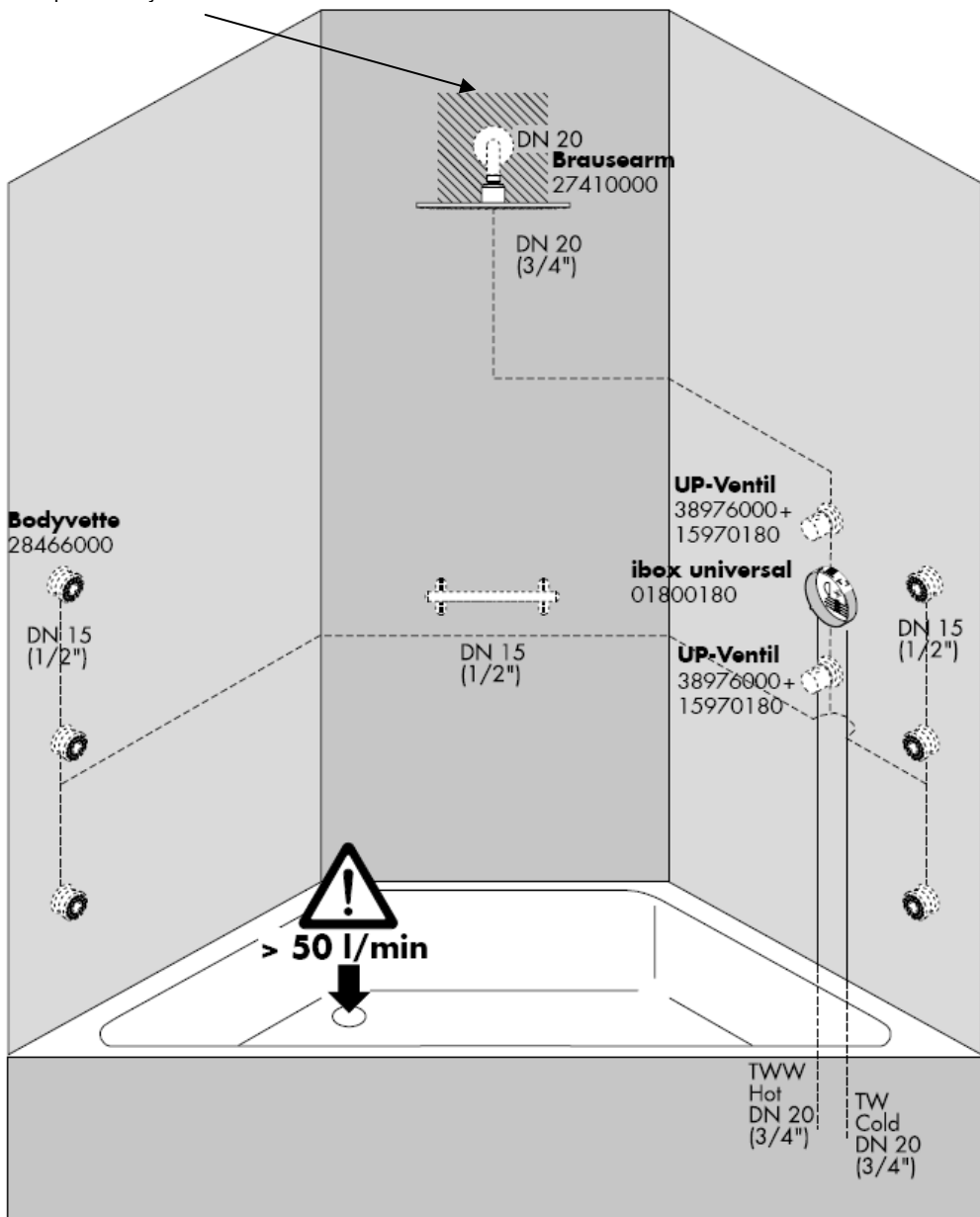

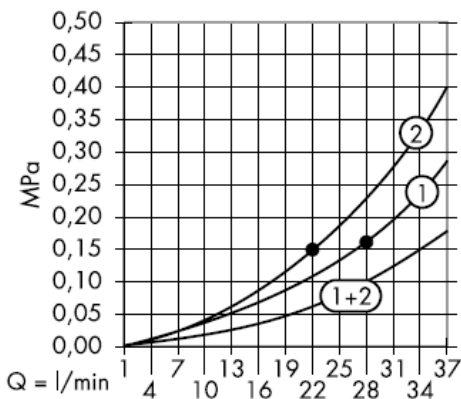

Od • je zaručená funkce

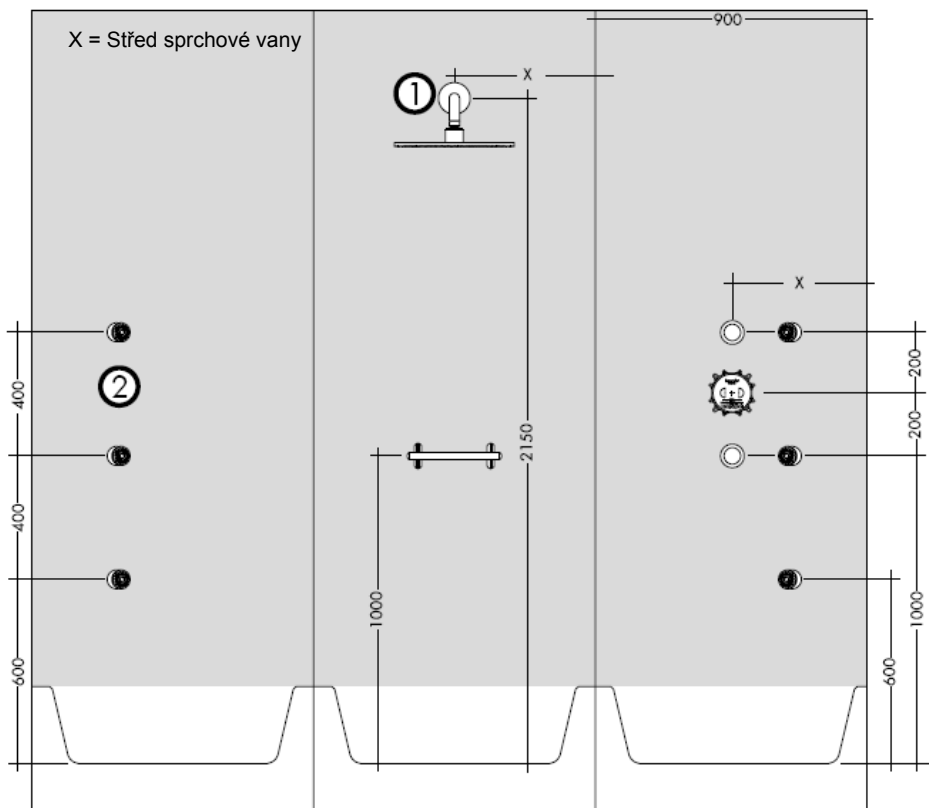

Oblast potřebnévyztužení zdi

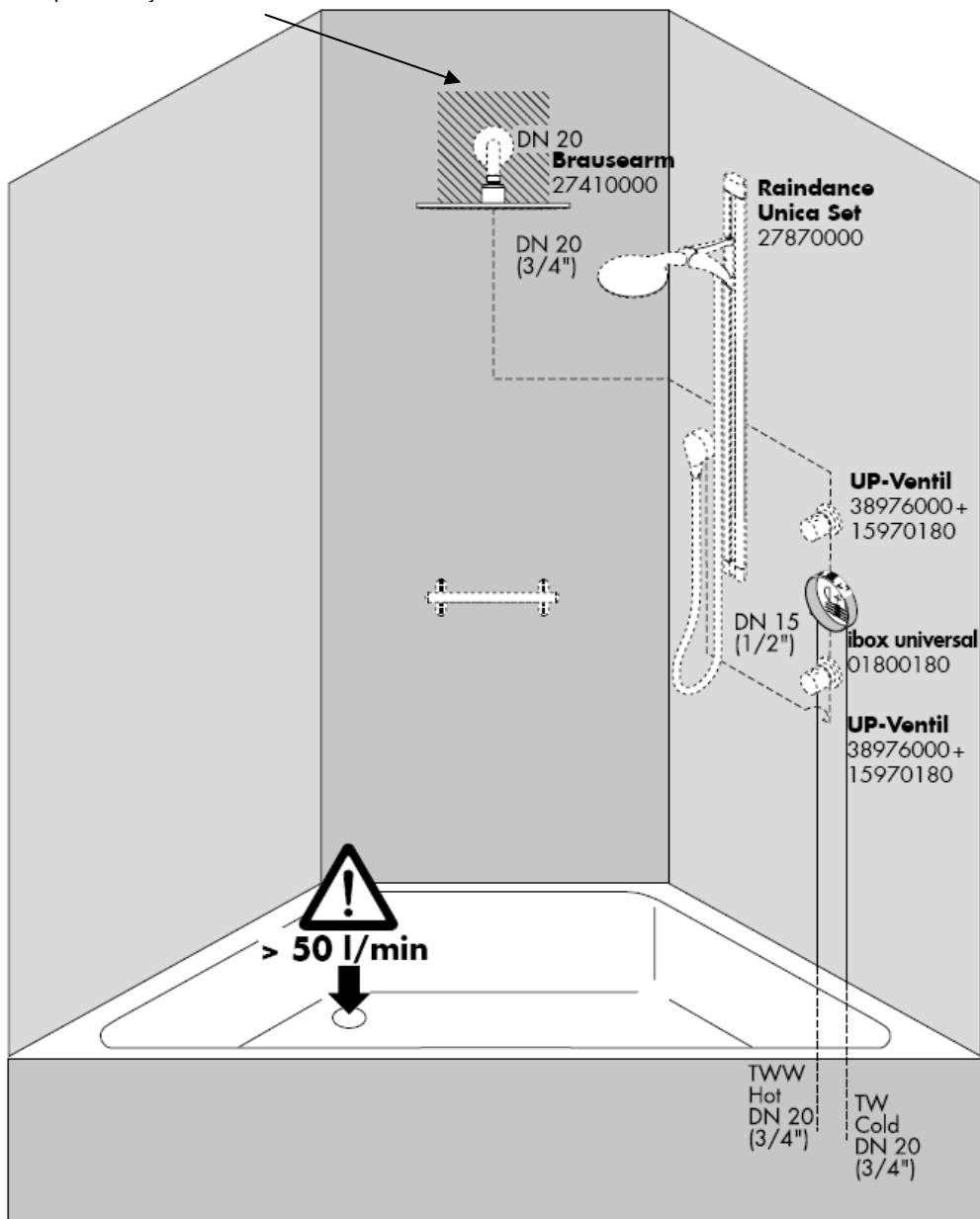

Oblast potřebnévyztužení zdi

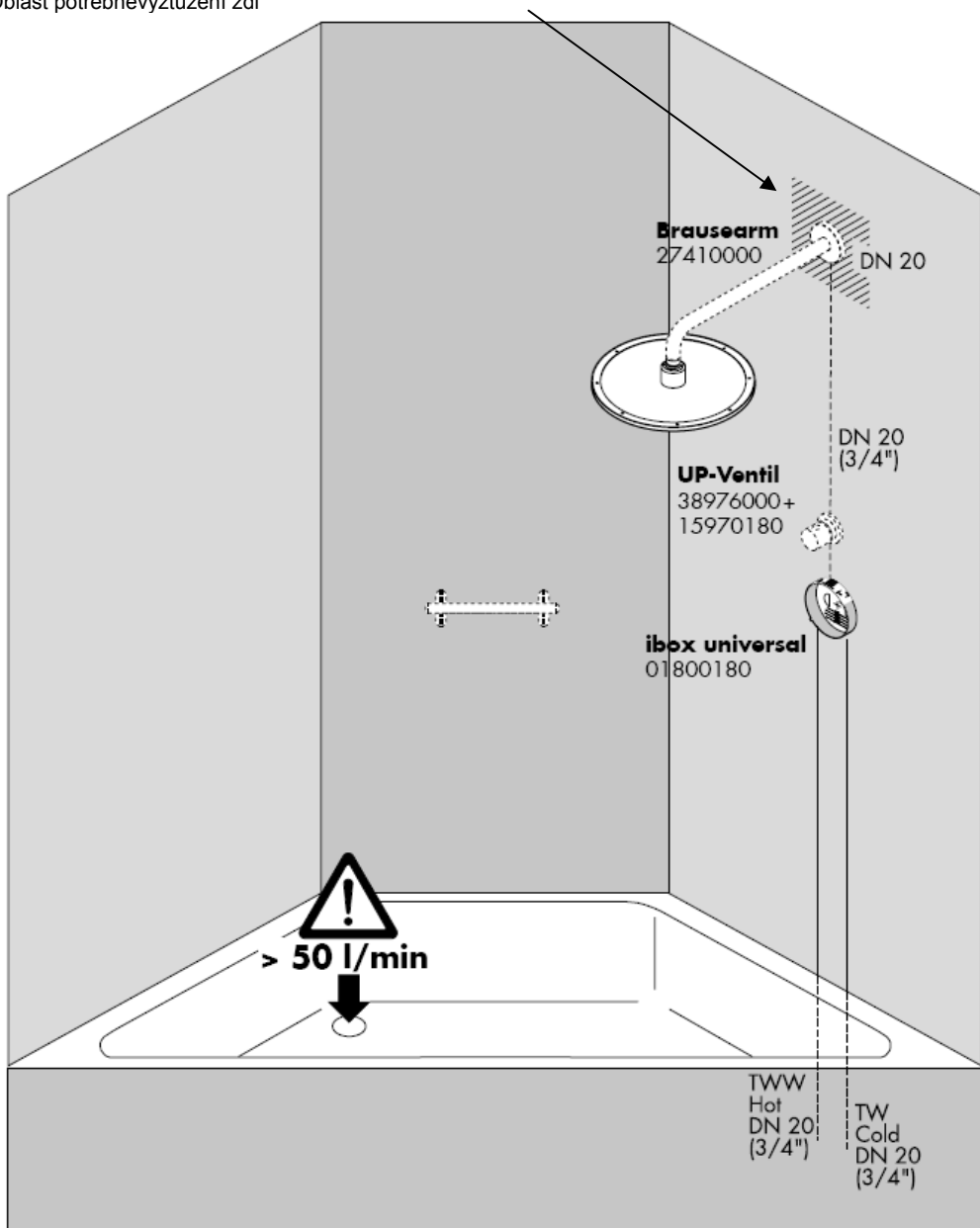

Od • je zaručená funkce

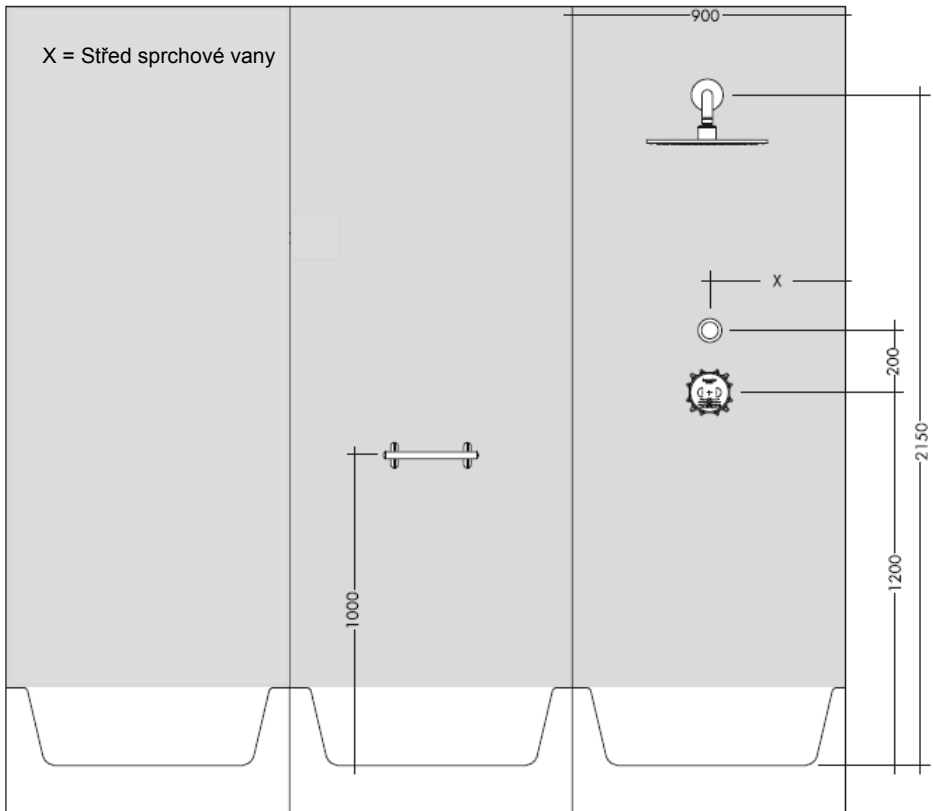
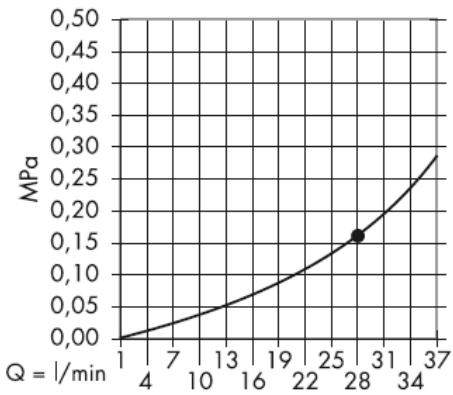

Oblast potřebnévyztužení zdi

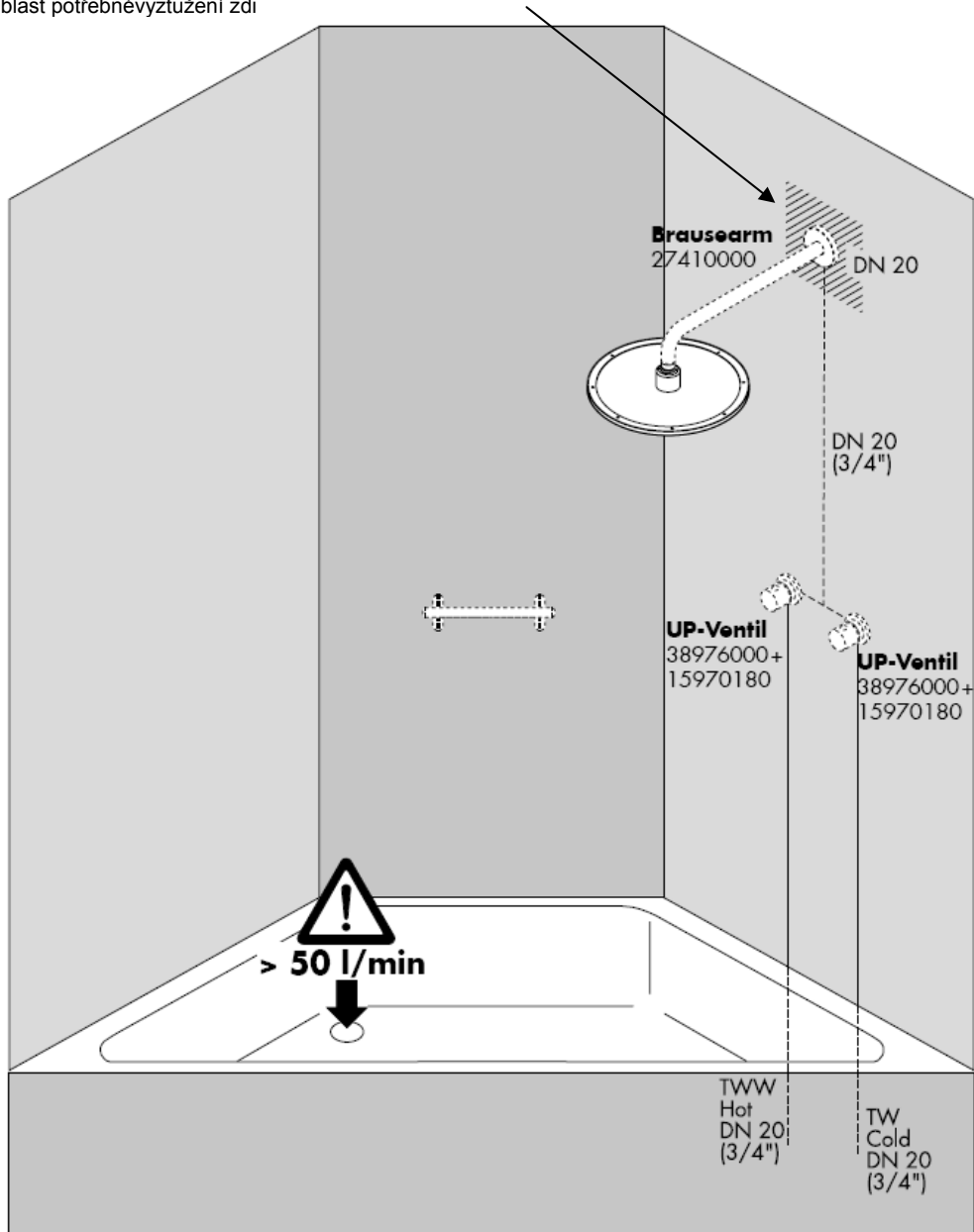

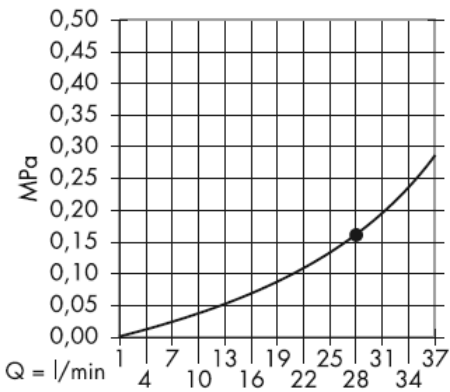

Od • je zaručená funkce

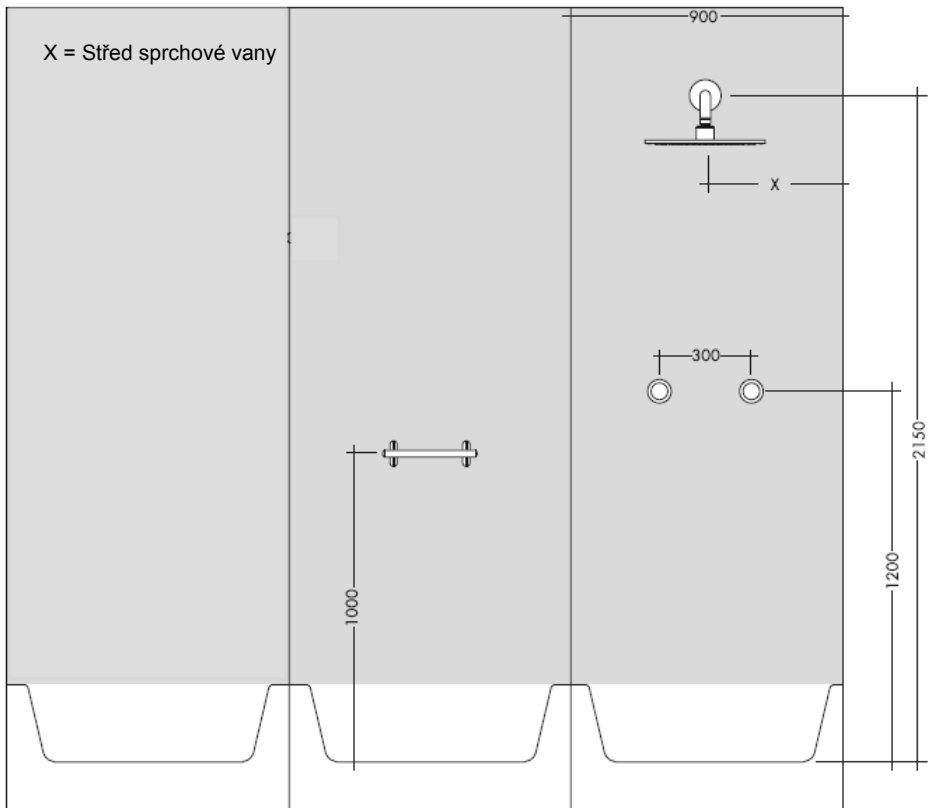

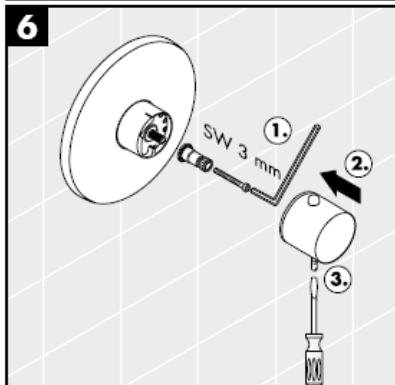
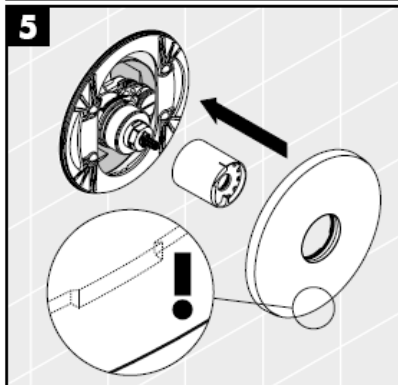
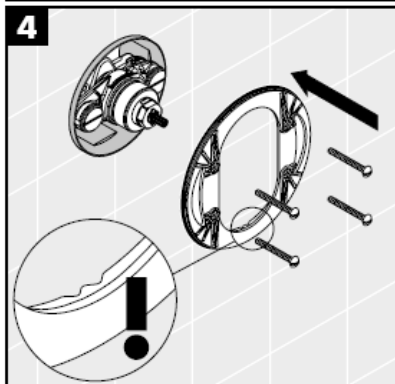
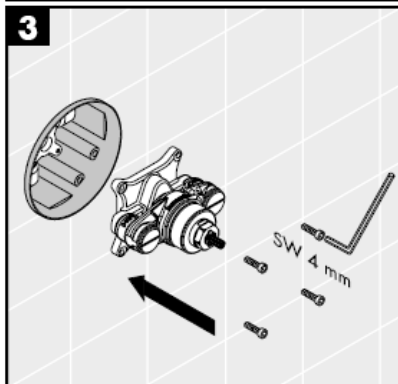
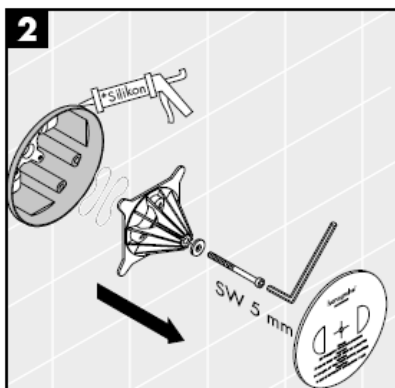
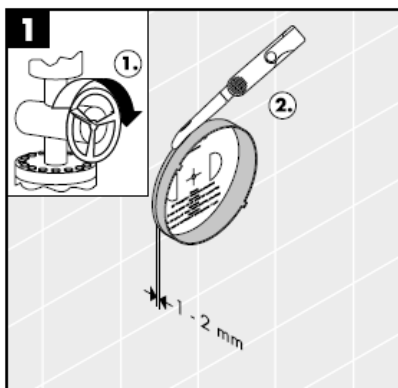

Silikon (bez kyseliny octové!)

Díky Safety Function je možné předem nastavit nejvyšší požadovanou teplotu, např. max. 42 C.

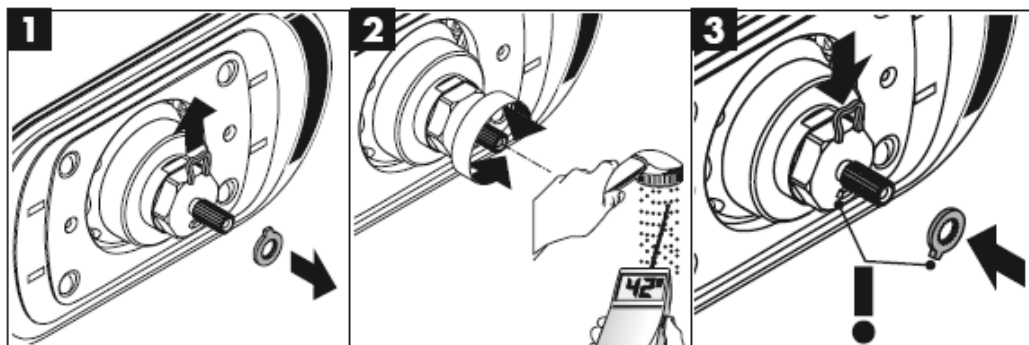

Nastavení

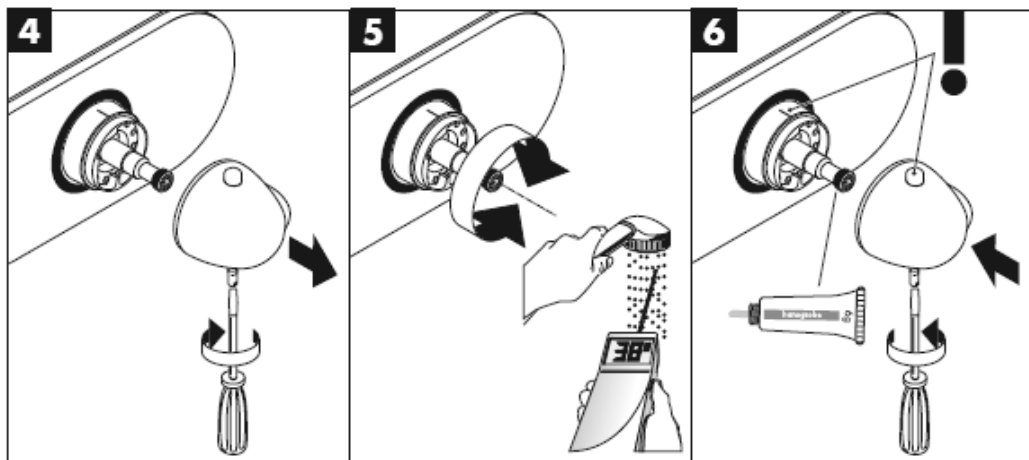



Jestliže je sprcha ve funkčním stavu, má spolu s ramenem sprchy hmotnost cca 10 kg. Proto smí být používán upevňovací materiál vhodný pouze pro zdivo! Příložené šrouby a hmoždinky jsou určeny pouze pro masivní zdivo.

Smí se použít pouze takový upevňovací materiál, který je pro zdivo vhodný! Příložené vruty a hmoždinky jsou určeny pouze pro plné zdivo.

Propustnost odpadu musí být dostatečně dimenzována.

Optimální funkce je zaručena pouze s High Flow termostaty Hansgrohe.

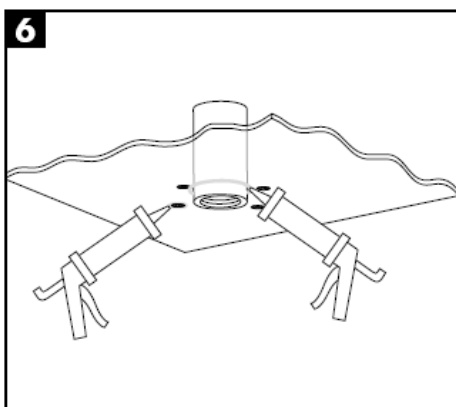
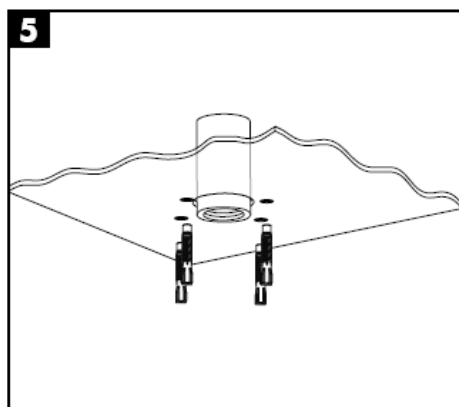
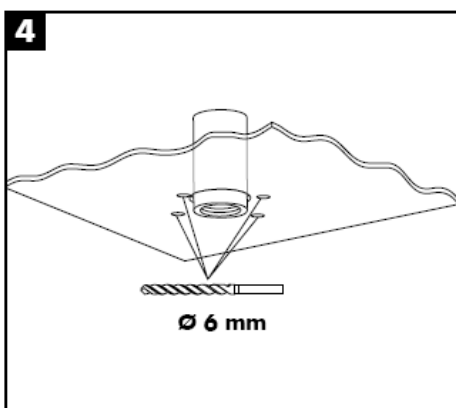
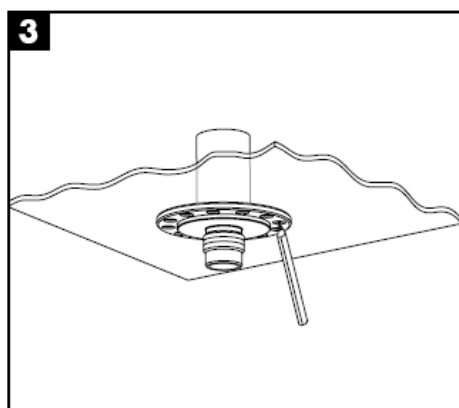
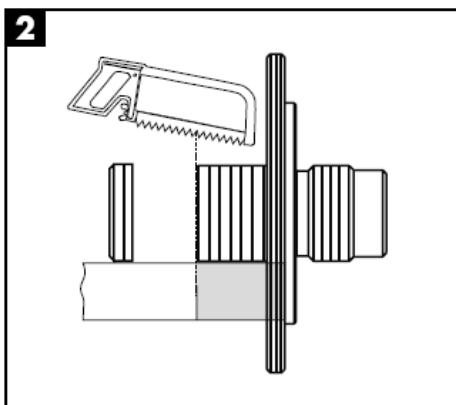
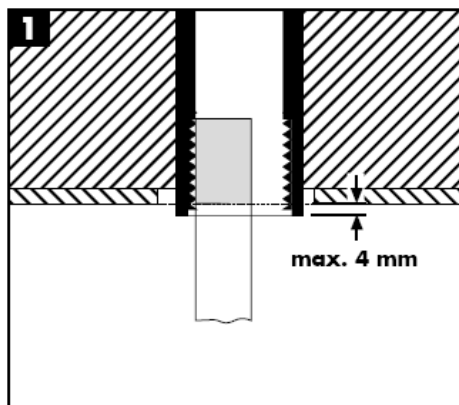

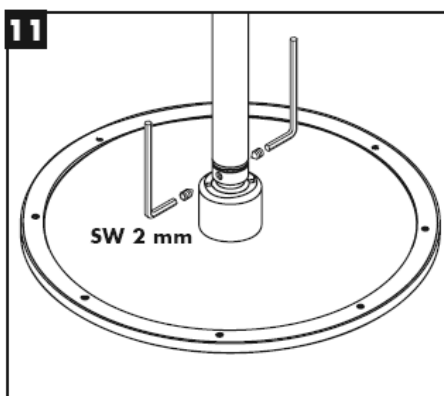
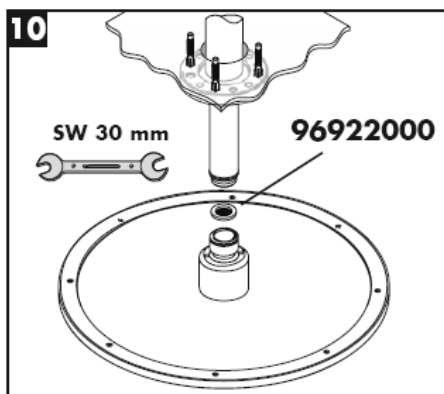
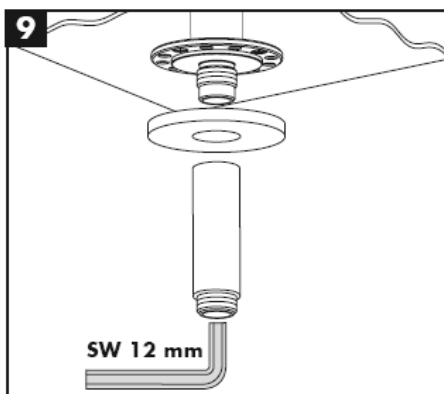
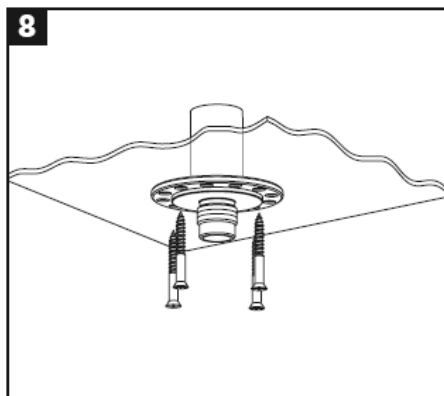
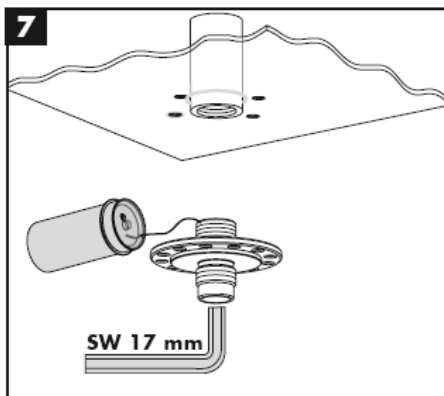

Do přívodu musí být zabudováno se sprchou dodávané sítko, aby zachycovalo nečistoty vyplavené z vodovodní sítě. Vyplavené nečistoty mohou ovlivnit funkci sprchy a nebo mohou vést i k jejímu poškození. Na takto vzniklé škody se nevztahuje záruka firmy Hansgrohe.

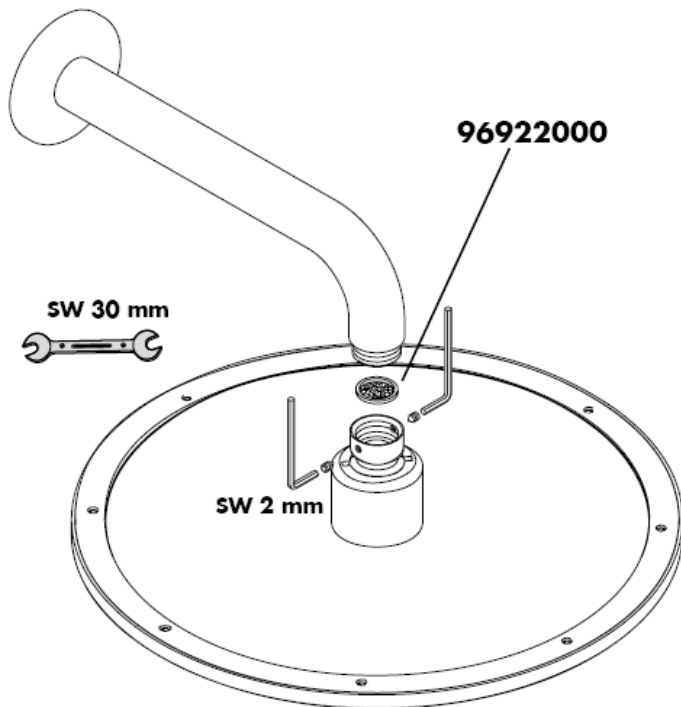

Montáž

Pozor! Armatura se musí montovat, proplachovat a testovat podle platných norem!

Nastavení

Jestliže se v místě odběru liší změřená teplota od teploty nastavené na termostatu, je třeba provést korekci.

Postupuje se takto: Otáčejte rukojetí se stupnicí, až má voda v místě odběru 38 °C. Uvolněte šroub rukojeti, rukojeť stáhněte a natočte ji do polohy pro 38 °C. Rukojeť nasuňte zpět a utáhněte šroub rukojeti (viz strana 22).

Omezení teploty

Rozsah teplot je bezpečnostní pojistkou omezen na 38 °C (ochrana proti opažení). Pokud se požaduje vyšší teplota, je možné překonat pojistku 38 stisknutím bezpečnostního tlačítka.

Safety Function

Díky Safety Function je možné předem nastavit nejvyšší požadovanou teplotu, např. max. 42 °C. viz strana 21.

Technické údaje

Provozní tlak:	max. 1 MPa
Doporučený provozní tlak:	0,1 – 0,5 MPa
Zkušební tlak:	1,6 MPa
(1 MPa = 10 bar = 147 PSI)	
Teplota horké vody:	max. 80° C
Doporučená teplota horké vody:	65° C
Průtok:	ca. 58 l/min 0,3 MPa

Údržba

Termostaty nevyžadují žádnou zvláštní údržbu. U zpětných ventilů se musí podle DIN EN 1717 v souladu s národními nebo regionálními předpisy testovat jejich funkčnost (alespoň jednou ročně). Zkontrolujte při této příležitosti také lapače nečistot, které se nacházejí na MTC regulační jednotce (6.1). Po montáži MTC regulační jednotky (6) zkontrolujte bezpodmínečně teplotu na výtoku, jak je popsáno v bodu „Nastavení“. Předtím rozhodně zkontrolujte, jestli je zapnuto zásobování teplou vodou a jestli je v místě odběru voda s maximální teplotou k dispozici.

Aby byl zajištěn lehký chod regulační jednotky, měl by se termostat čas od času nastavit na úplně horkou a úplně studenou vodu.

Servisní díly viz strana 3

1	rukojeť termostatu	38391000
2	rozeta	96452000
3	objímka	97439000
4	Nosné šrouby	96454000
5	Nosná rozeta	96447000
6	regulační jednotka teploty	96633000
7	Filtrační sítko	97367000
8	zpětný ventil	96655000
9	prodloužení 25 mm	13595000
10	prodloužení 25 mm	13596000

Česky

Porucha	Příčina	Odstranění
Málo vody	-Nízký tlak v přívodu. -Zanesený lapač nečistot v regulační jednotce -Sítko v těsnění u sprchy zanesené	-Zkontrolovat tlak v potrubí -Vyčistit sítko lapačů nečistot -Vyčistit sítko v těsnění mezi sprchou a hadicí
Křížení toků, teplá voda se při zavřené armatuře tlačí do přívodu studené vody nebo naopak	-Znečištěný nebo netěsný zpětný ventil	-Vyměnit zpětný ventil
Teplota u výtoku nesouhlasí s nastavenou teplotou	-Teplota u výtoku nesouhlasí s nastavenou teplotou -nízká teplota teplé vody	-Nastavit termostat -Teplotu horké vody zvýšit na 42 C až 65 C
Nelze regulovat teplotu	-Regulační jednotka teploty znečištěná nebo zanesená vodním kamenem -Funkční blok zabudovat otočený o 180	-U nové instalace: obráceně připojené základní těleso (má být studená vpravo, teplá vlevo) nebo zabudované otočené o 180 -Tlačítko bezpečnostní pojistky je nefunkční
Vadná pružina	-Pružinu nebo tlačítko očistit a lehce potřít tukem, případně vyměnit -Tlačítko zanesené vodním kamenem	-Pružinu nebo tlačítko očistit a lehce potřít tukem, případně vyměnit -Pružinu nebo tlačítko očistit a lehce potřít tukem, případně vyměnit

zkušební značka

	P-IX	DVGW	SVGW	WRSA	KIWA	ACS	NF
27070000						X	
27418XXX							
28420000						X	
28435XXX						X	

Čištění

Jednoduše čisté: Vapenné usazeniny můžete z nopků snadno odstranit otřením.

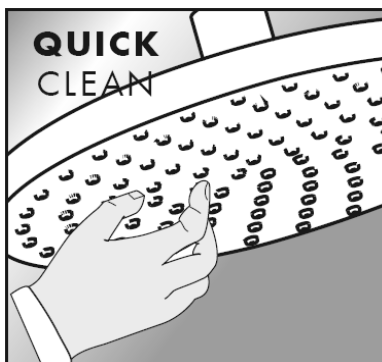

Návod na čištění

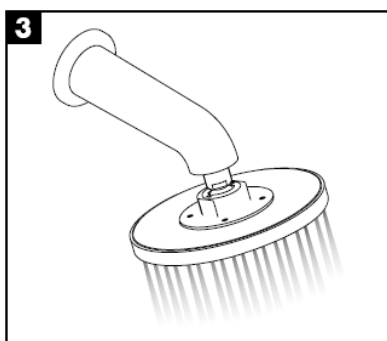
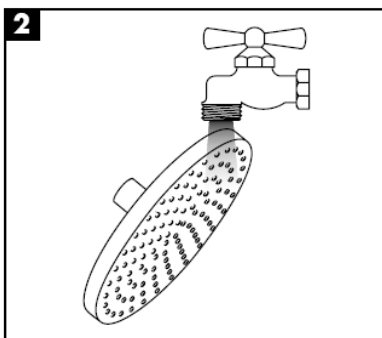
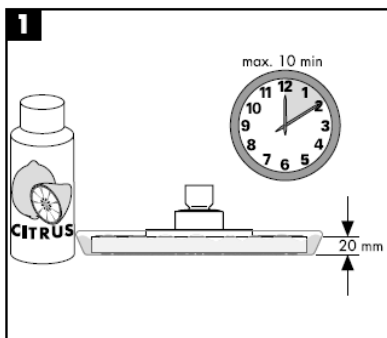

hansgrohe

Hansgrohe · Postfach 1145 · D-77761 Schiltach · Telefon +49 (0) 78 36/51-1282 · Telefax +49 (0) 7836/511440
E-Mail: info@hansgrohe.com · Internet: www.hansgrohe.com

07/2008
9.05170.04
Česky

Montážny návod



27418XXX

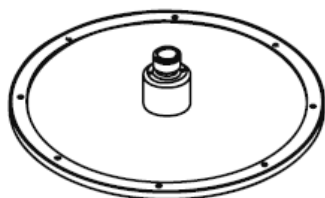

Raindance Royale AIR
28420000

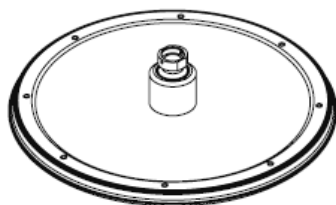

Raindance Royale Classic AIR
28435XXX

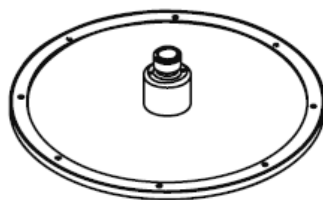

**Raindance Royale
High Flow Set**
27070000

hansgrohe

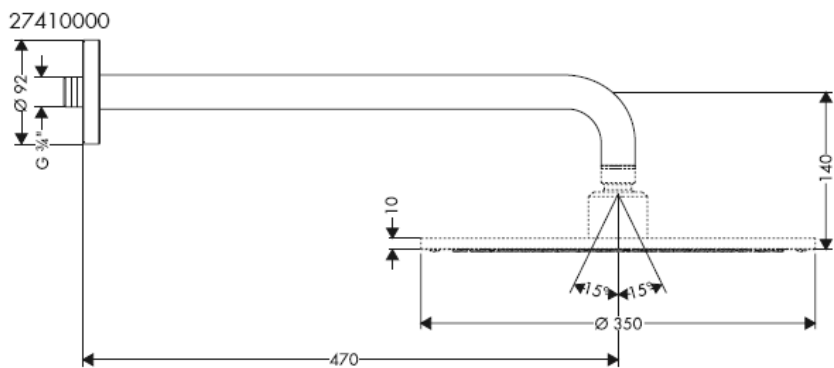
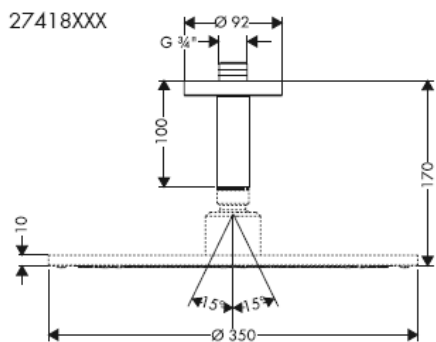
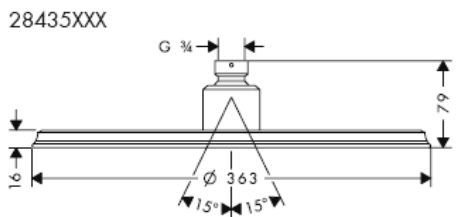
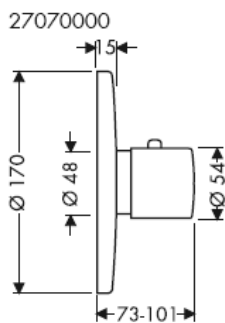
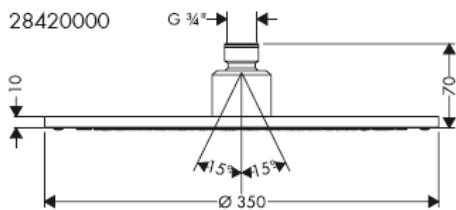

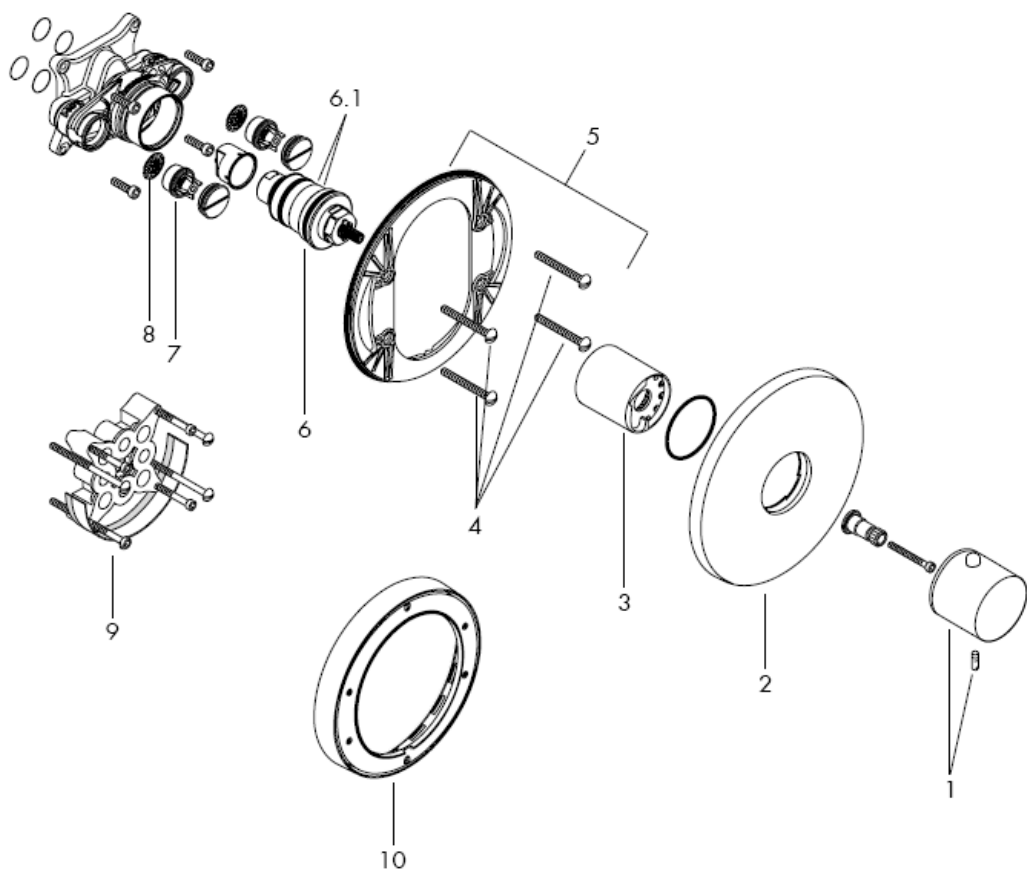

Rozmery, pokiaľ možno prispôbiť rozloženiu obkladov.

Pre upevnenie sprchy je nutné zosilnenie steny

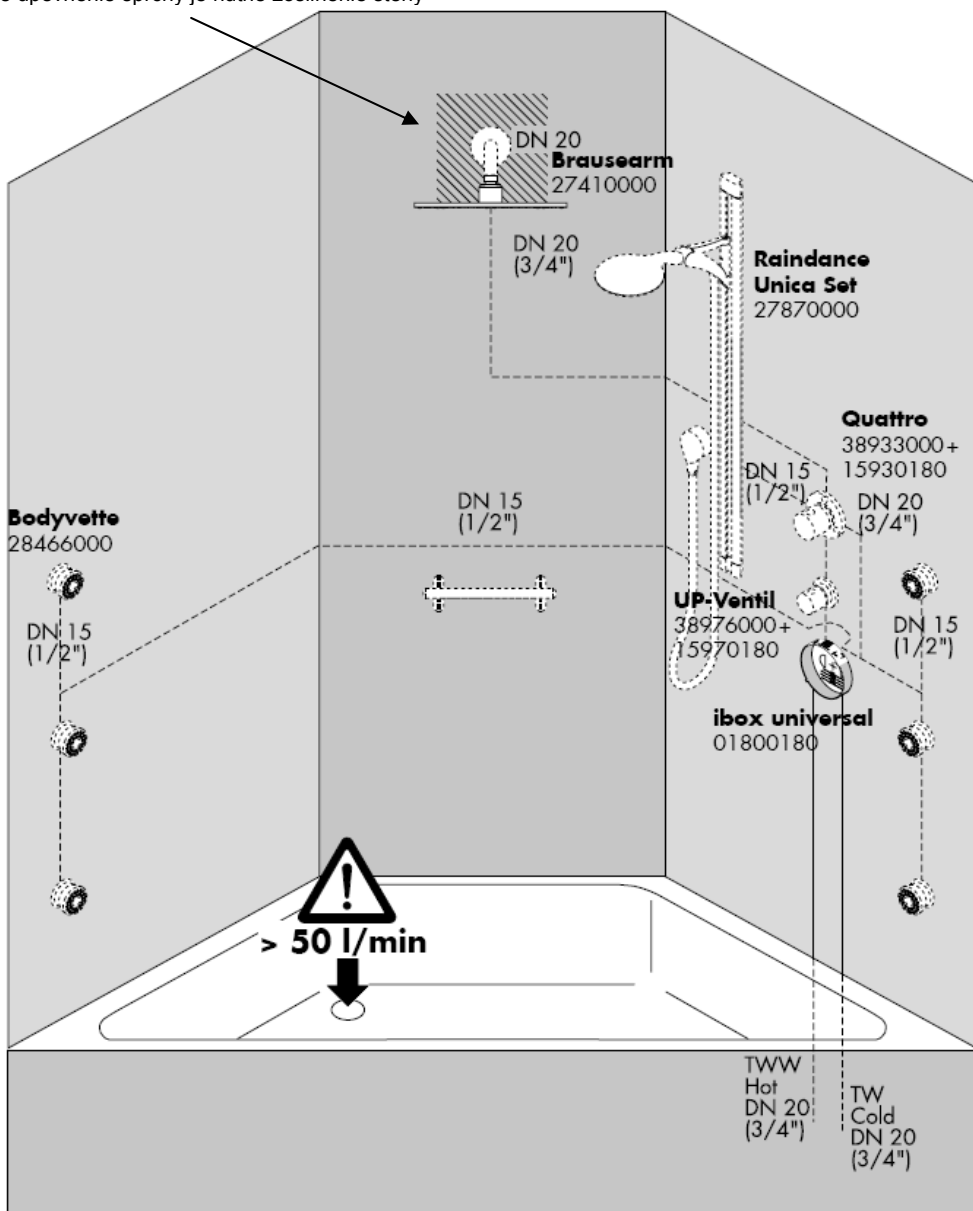

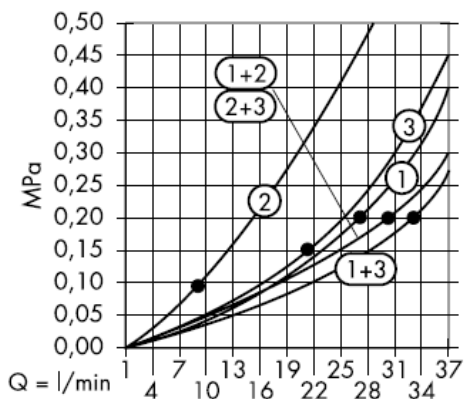

Od • je zaručená funkcia.

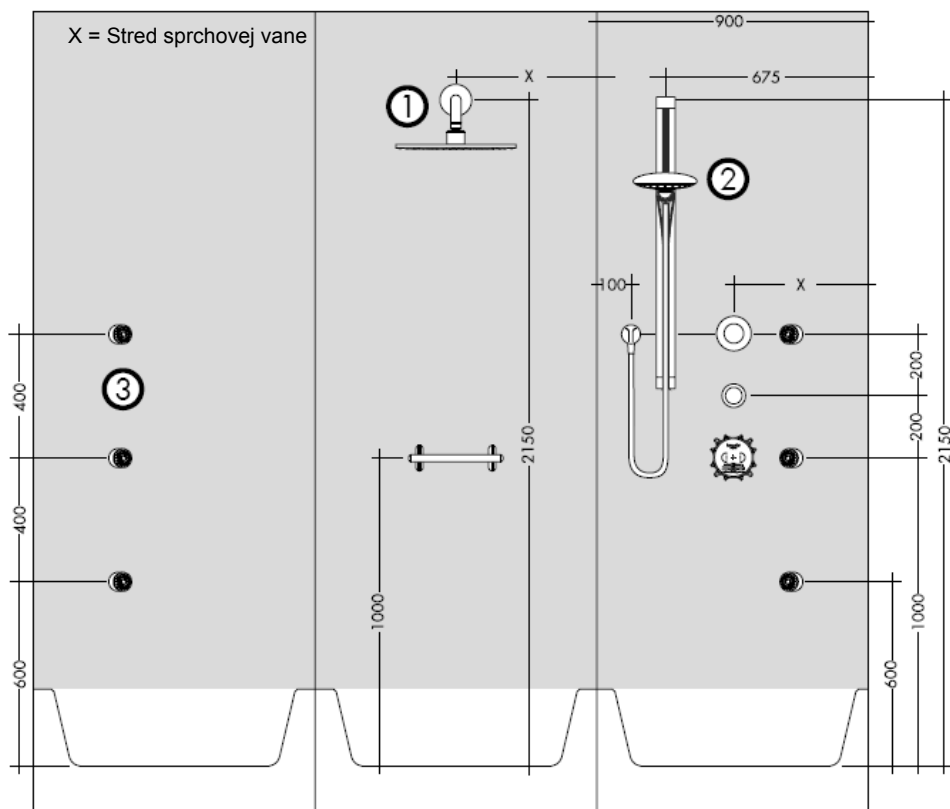

Pre upevnenie sprchy je nutné zosilnenie steny

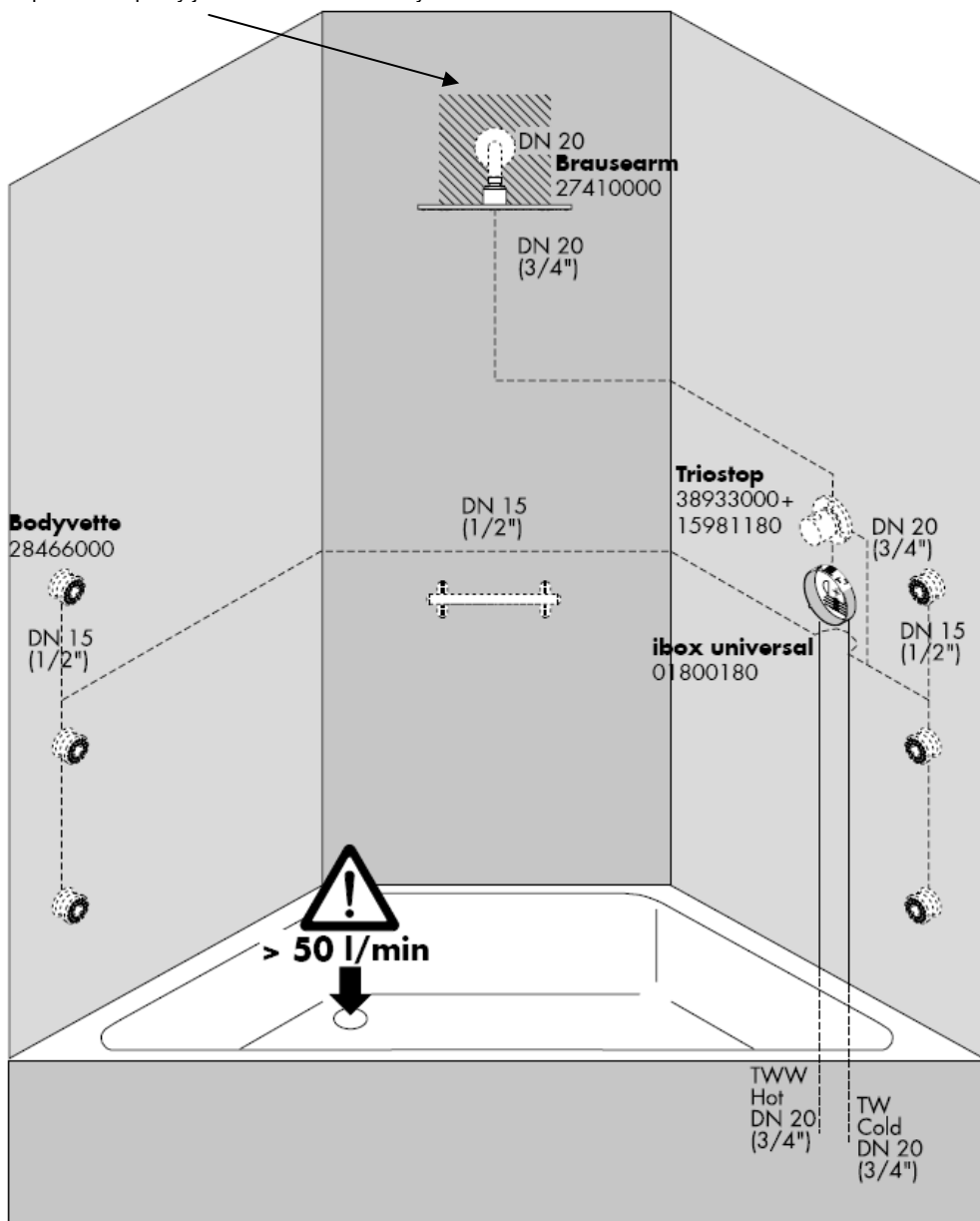

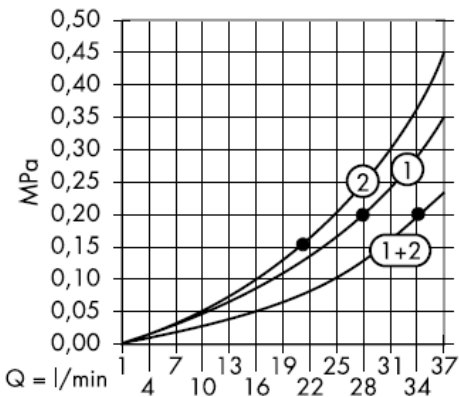

Od • je zaručená funkcia.

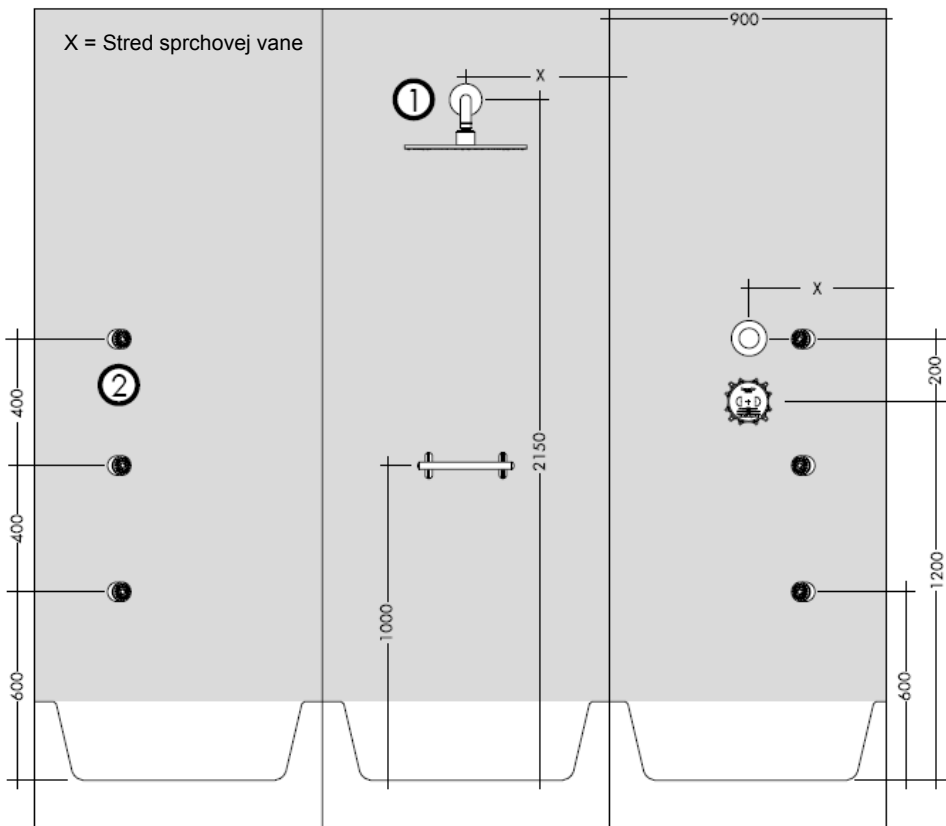

Pre upevnenie sprchy je nutné zosilnenie steny

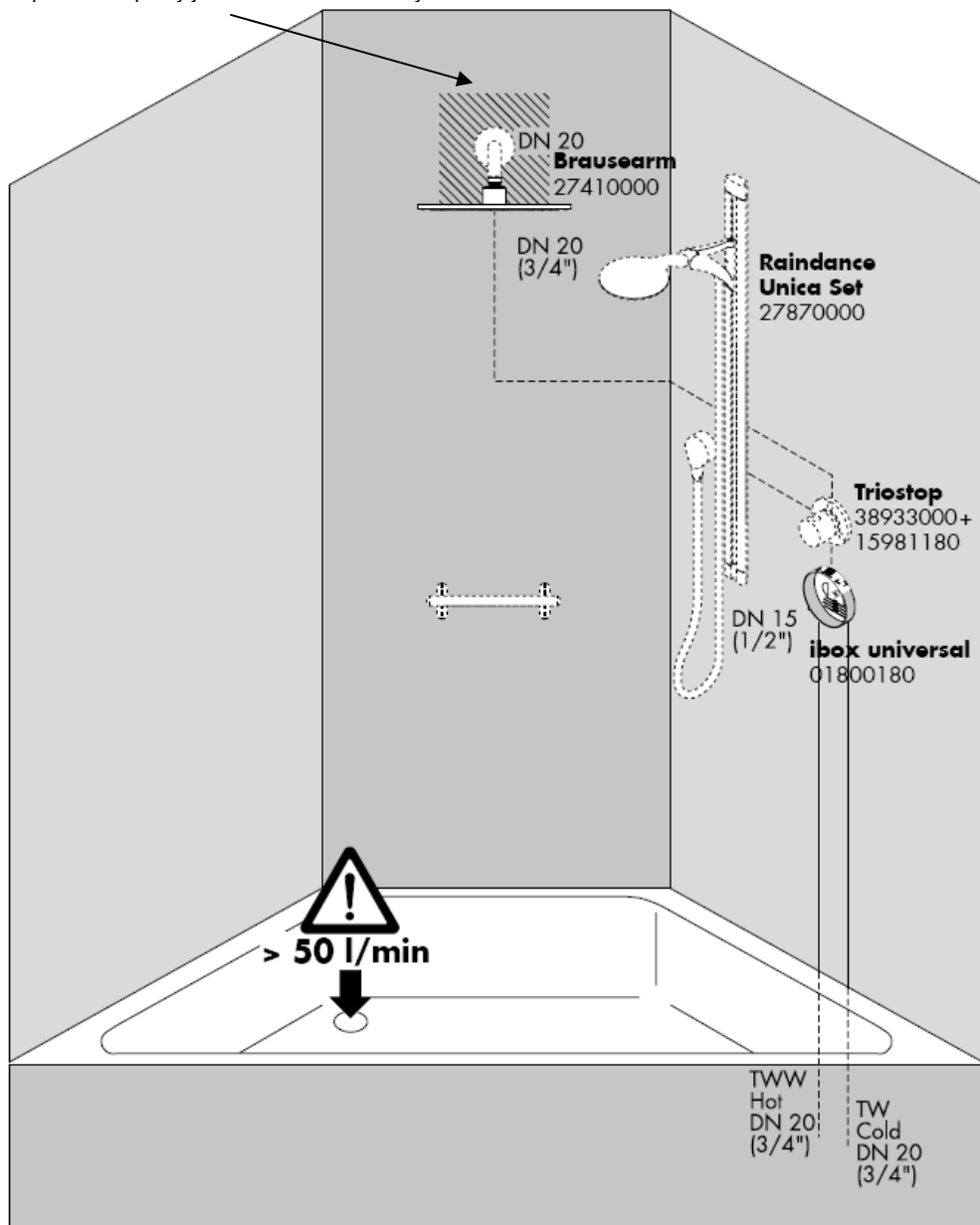

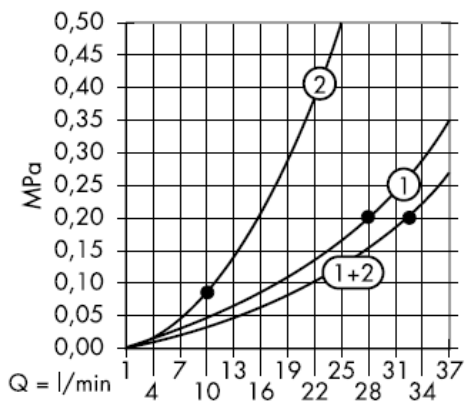

Od • je zaručená funkcia.

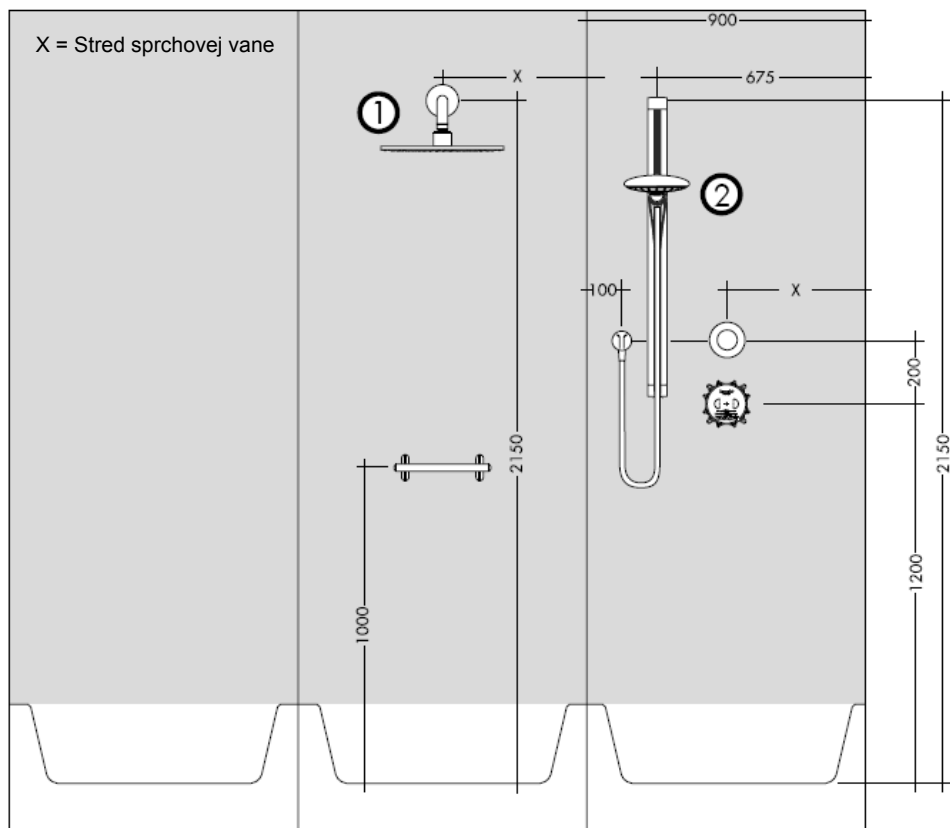

Pre upevnenie sprchy je nutné zosilnenie steny

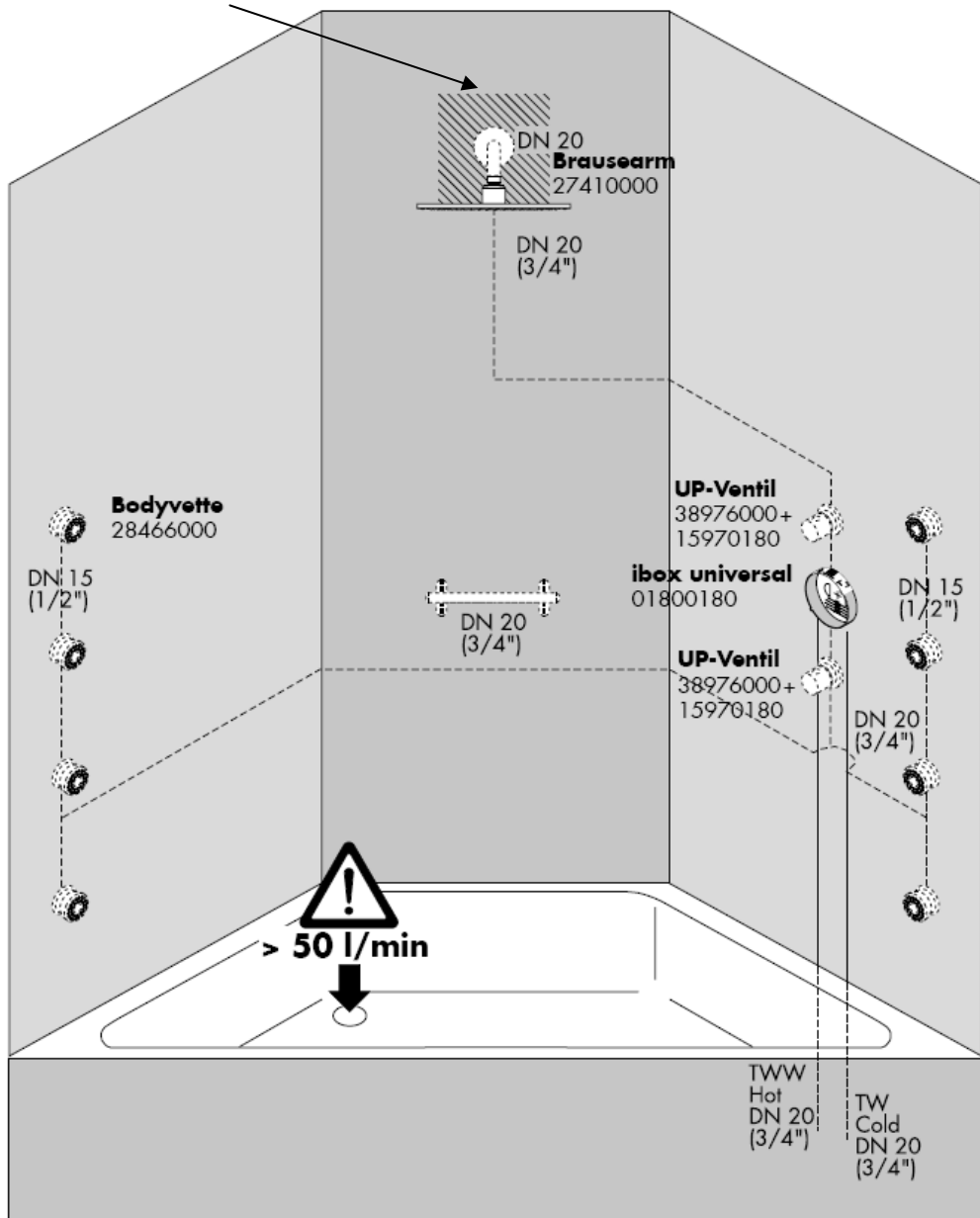

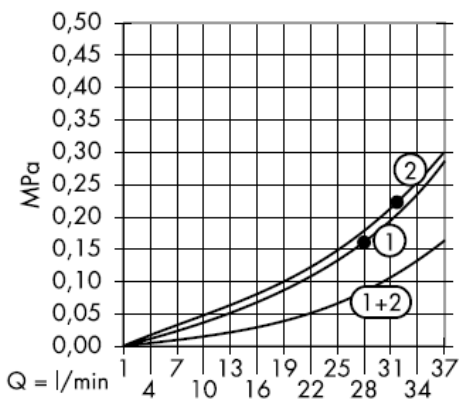

Od • je zaručená funkcia.

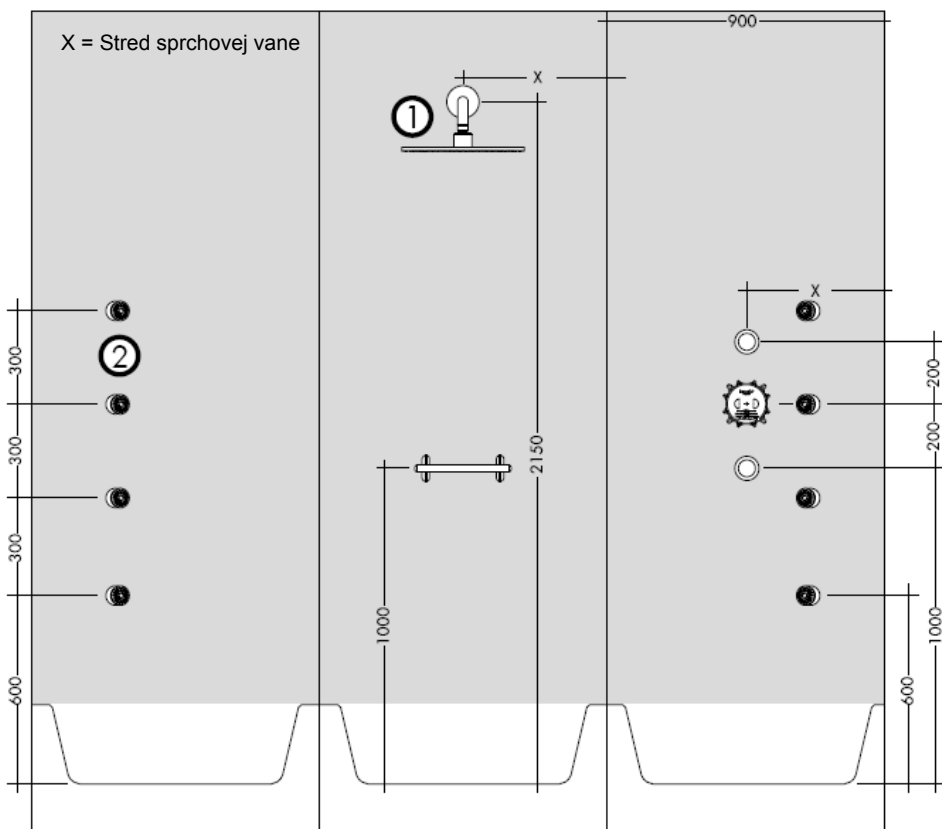

Pre upevnenie sprchy je nutné zosilnenie steny

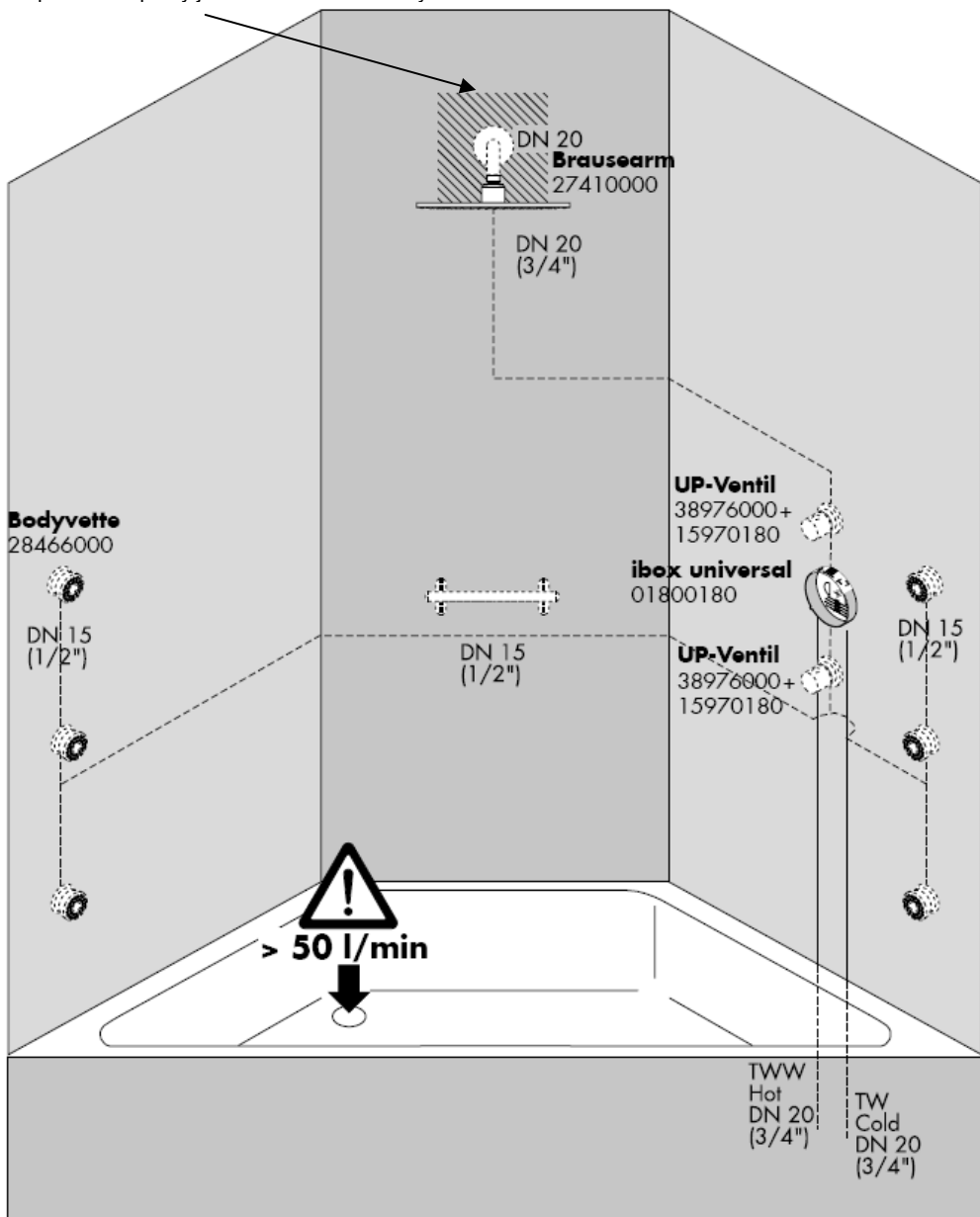

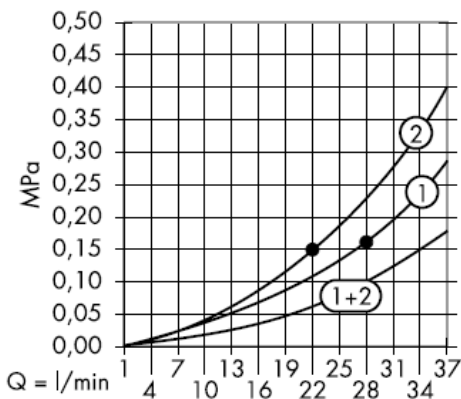

Od • je zaručená funkcia.

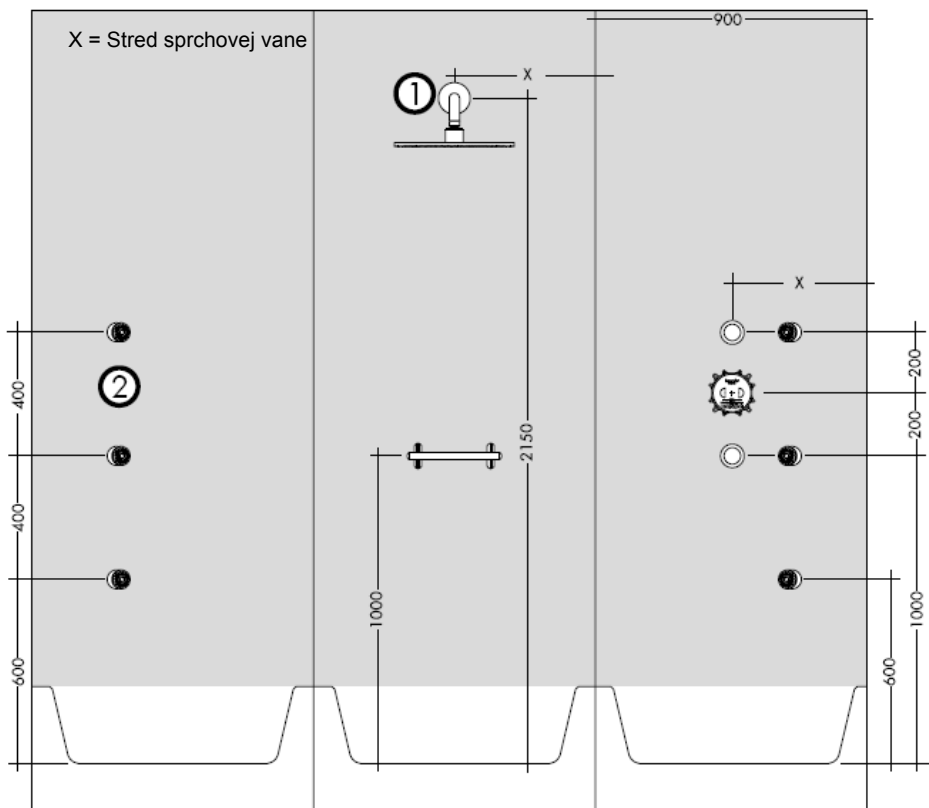

Pre upevnenie sprchy je nutné zosilnenie steny

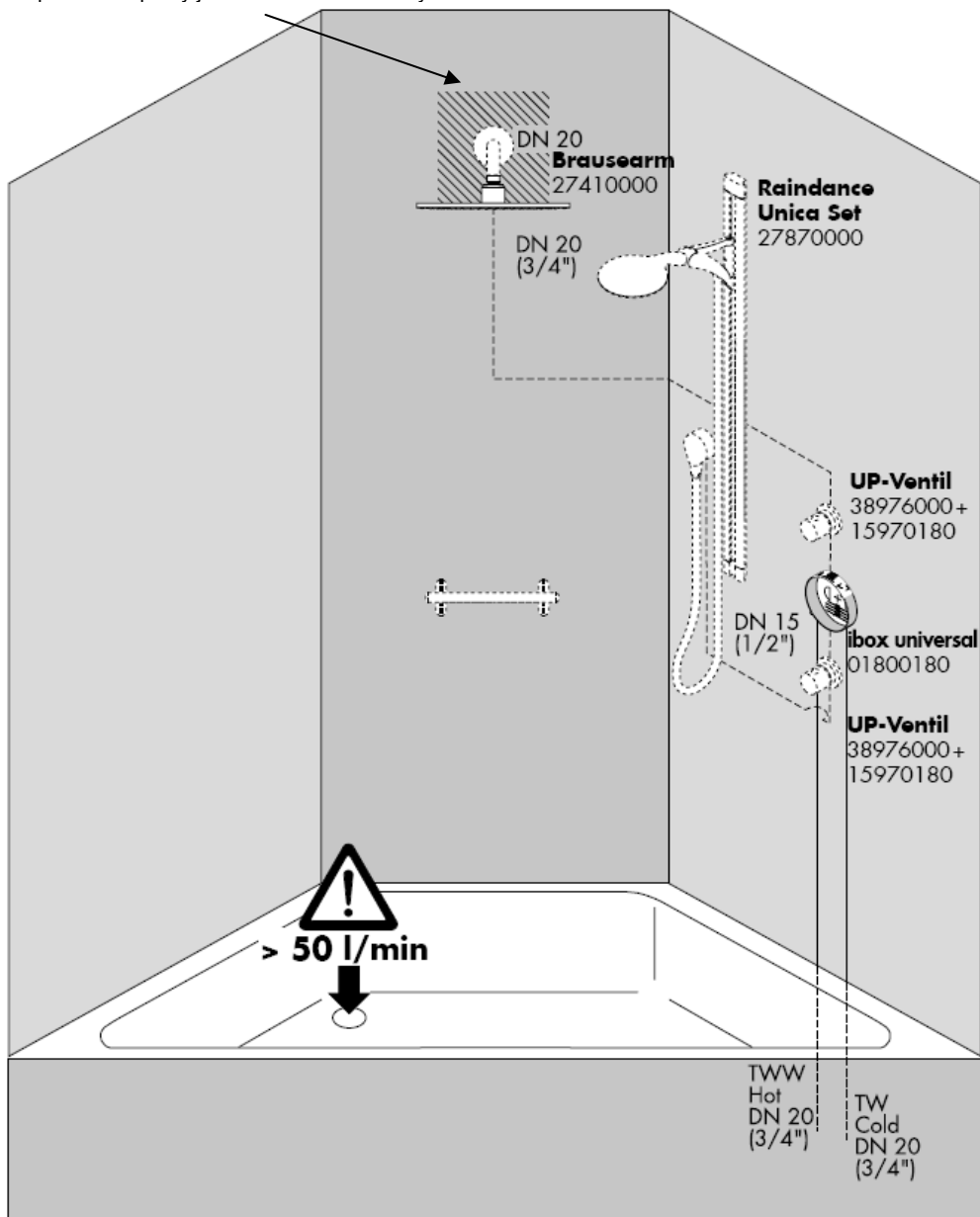

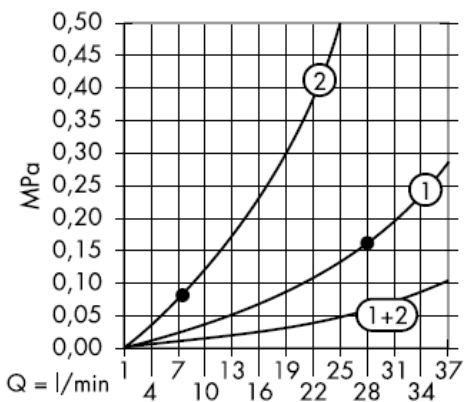

Od • je zaručená funkcia.

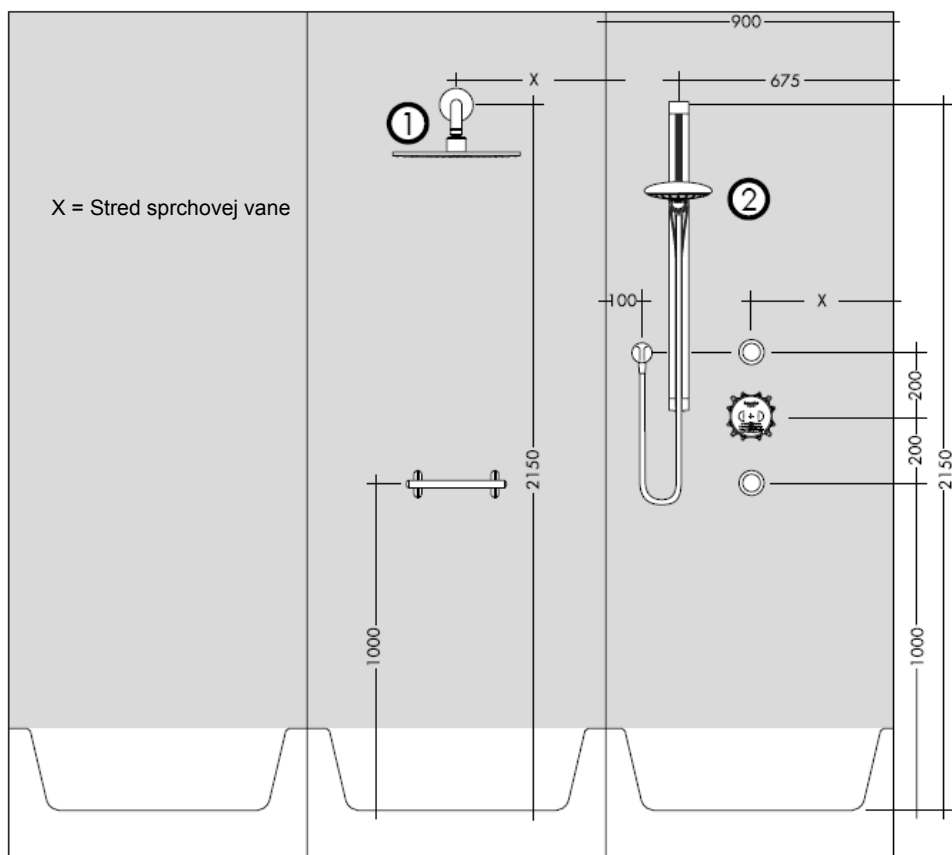

Pre upevnenie sprchy je nutné zosilnenie steny

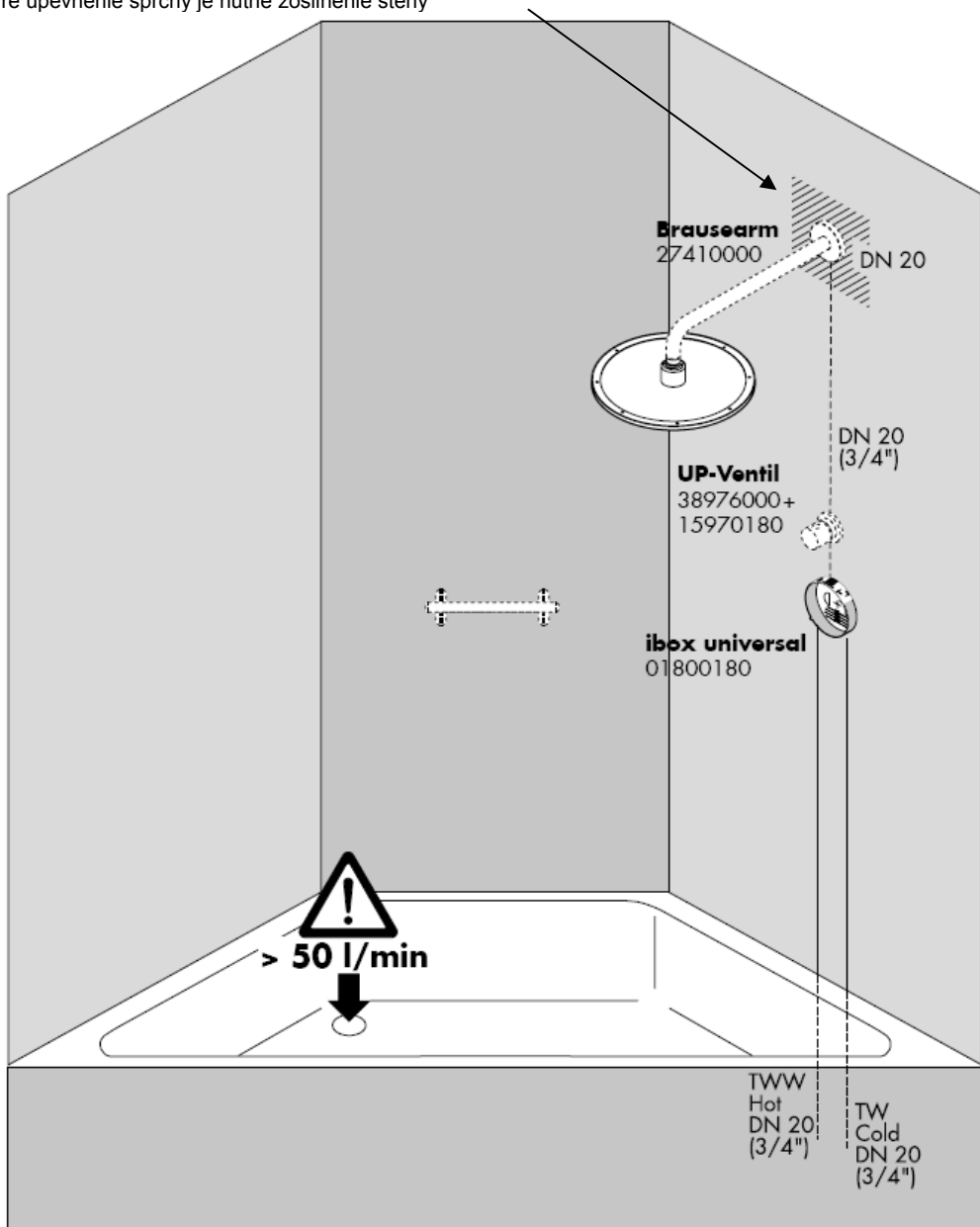

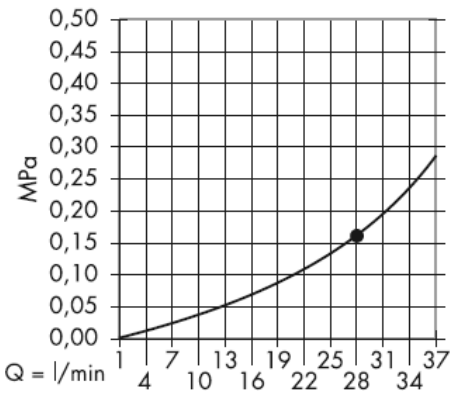

Od • je zaručená funkcia.

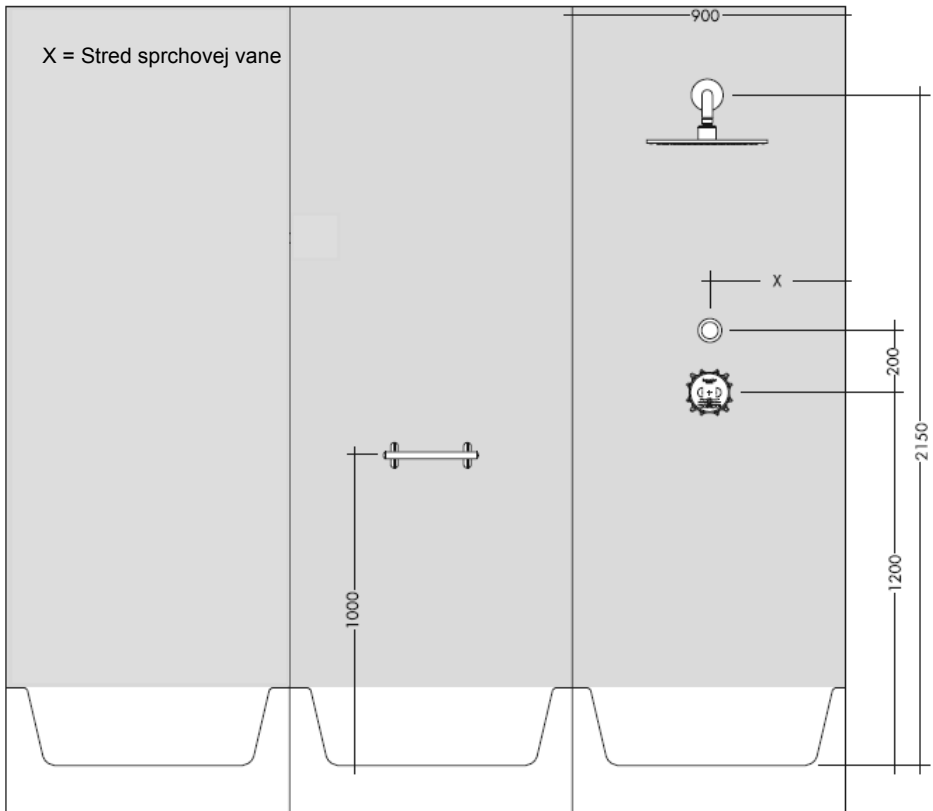

Pre upevnenie sprchy je nutné zosilnenie steny

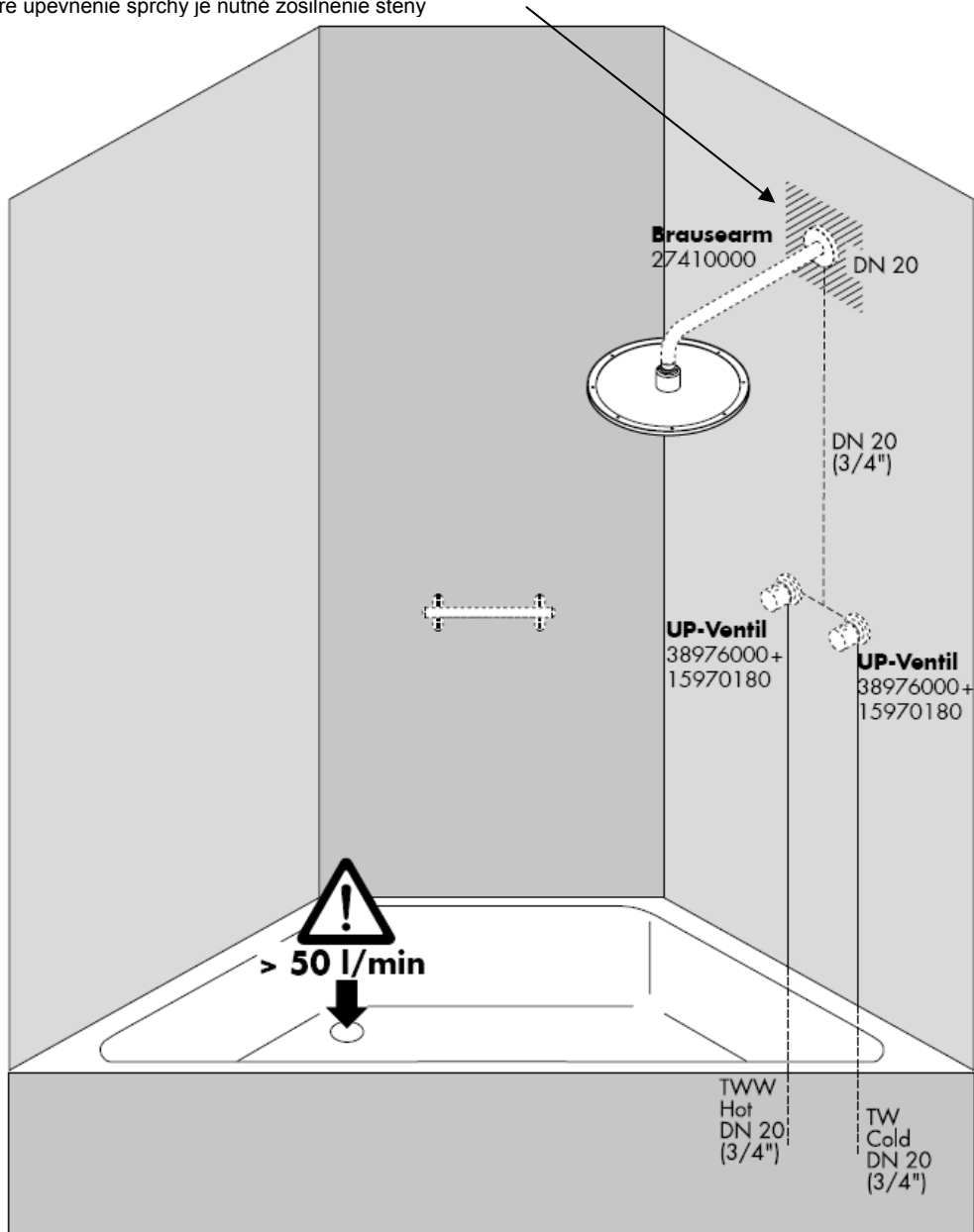

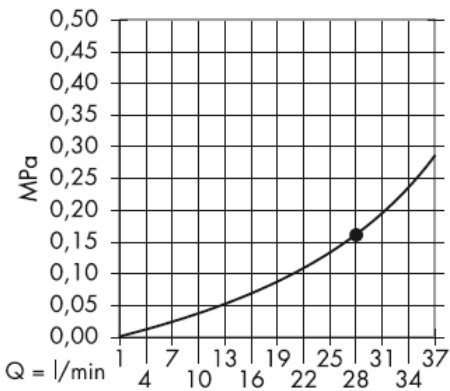

Od • je zaručená funkcia.

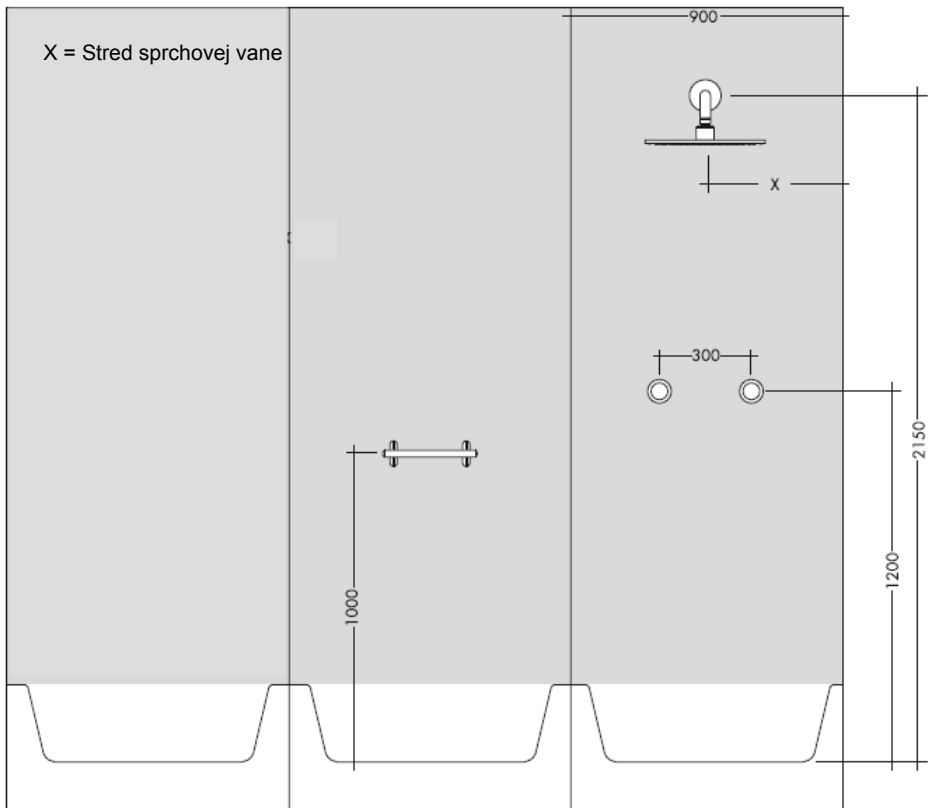

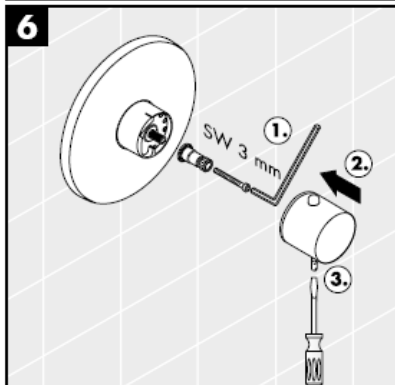
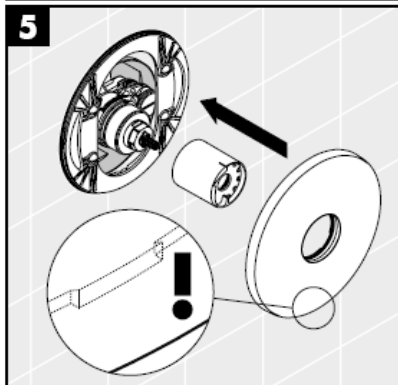
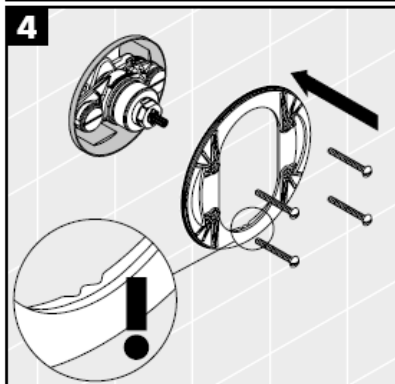
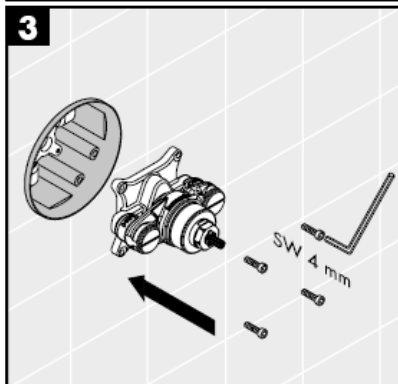
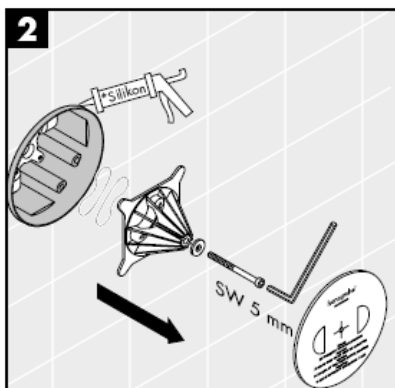
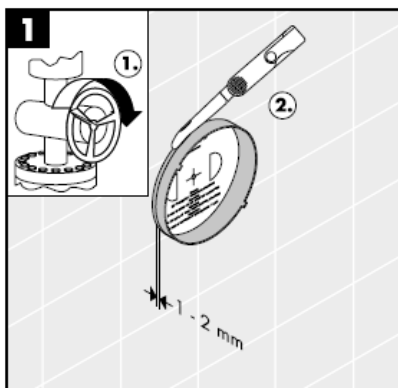

Silikon (bez kyseliny octovej!)

Vďaka Safety Function je možné vopred nastaviť najvyššiu požadovanú teplotu, napr. max. 42 C.

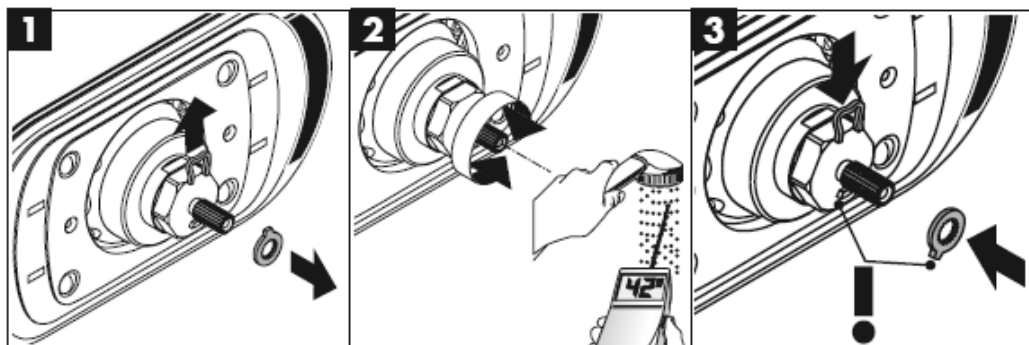

Nastavenie

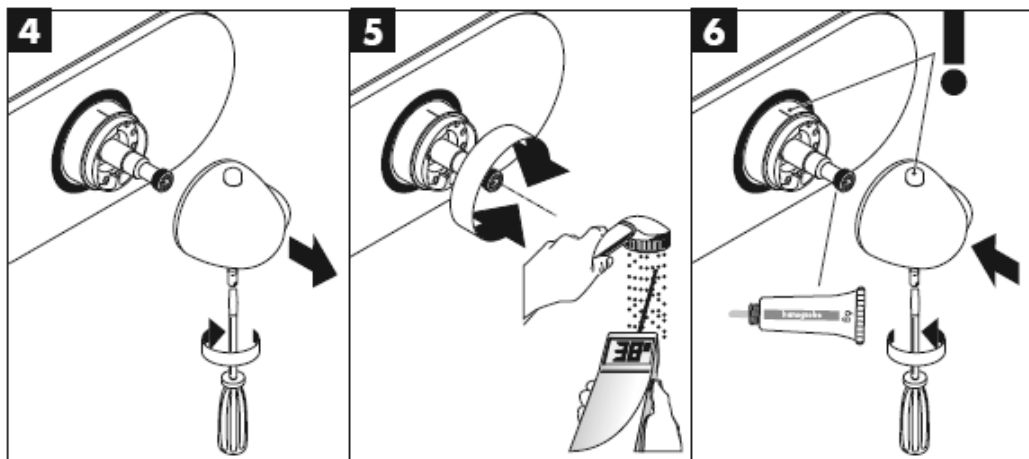



Ak je sprcha vo funkčnom stave, má spolu s ramenom sprchy hmotnosť cca 10 kg. Preto sa smie používať upevňovací materiál vhodný len pre murivo! Priložené skrutky a hmoždinky sú určené len pre masívne murivo.

Môže sa použiť iba taký upevňovací materiál, ktorý je pre murivo vhodný! Priložené skrutky a hmoždinky sú určené iba pre plné murivo.

Priepustnosť odpadu musí byť dostatočne dimenzovaná.

Optimálna funkcia je zaručená iba s High Flow termostaty Hansgrohe.

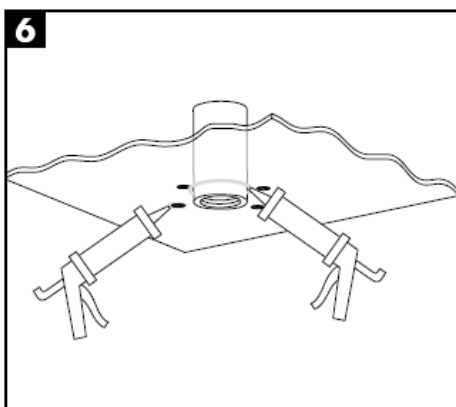
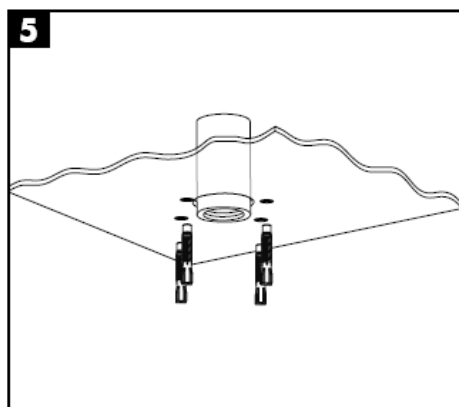
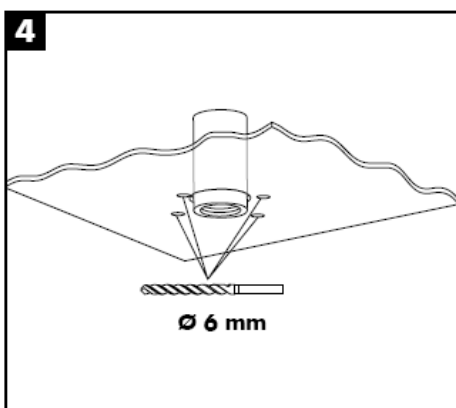
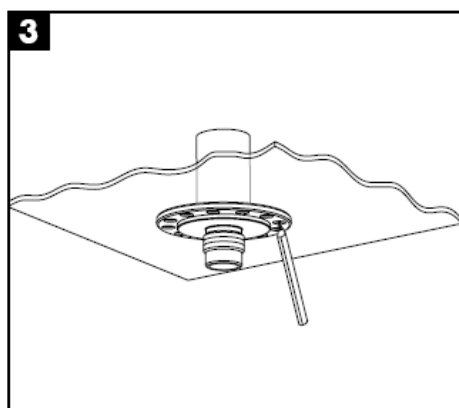
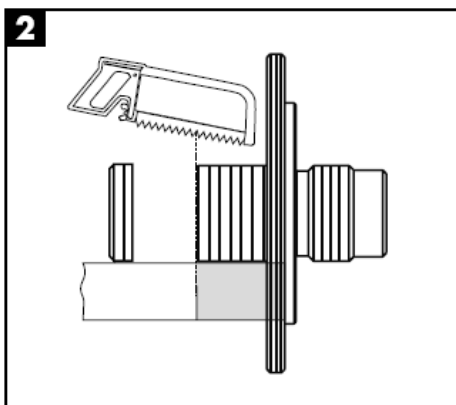
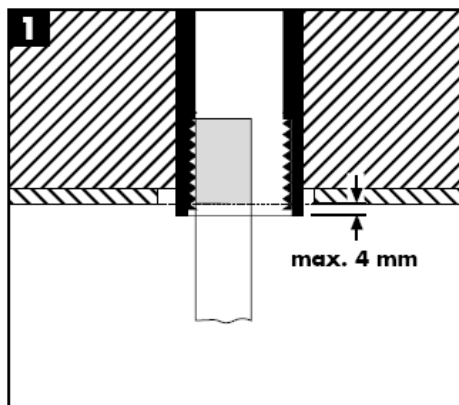

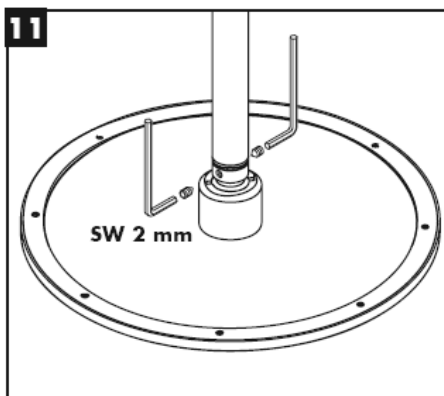
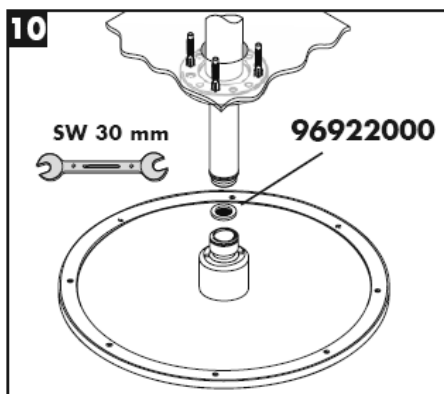
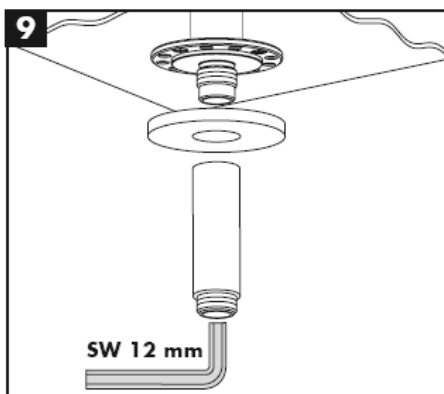
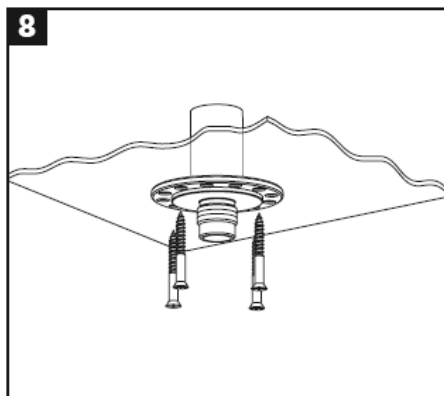
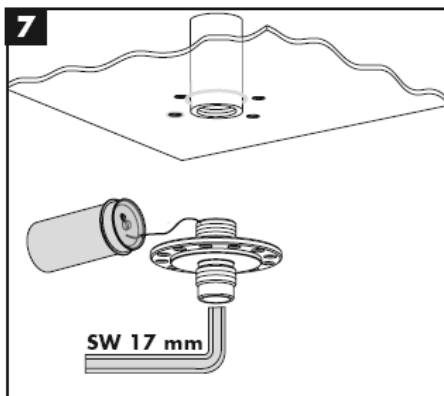

Do prívodu musí byť zabudované so sprchou dodávané sítka, aby zachytilo nečistoty vyplavené z vodovodnej siete. Vyplavené nečistoty môžu ovplyvniť funkciu sprchy, alebo spôsobiť jej poškodenie. Na takto vzniknuté škody sa nevzťahuje záruka firmy Hansgrohe.

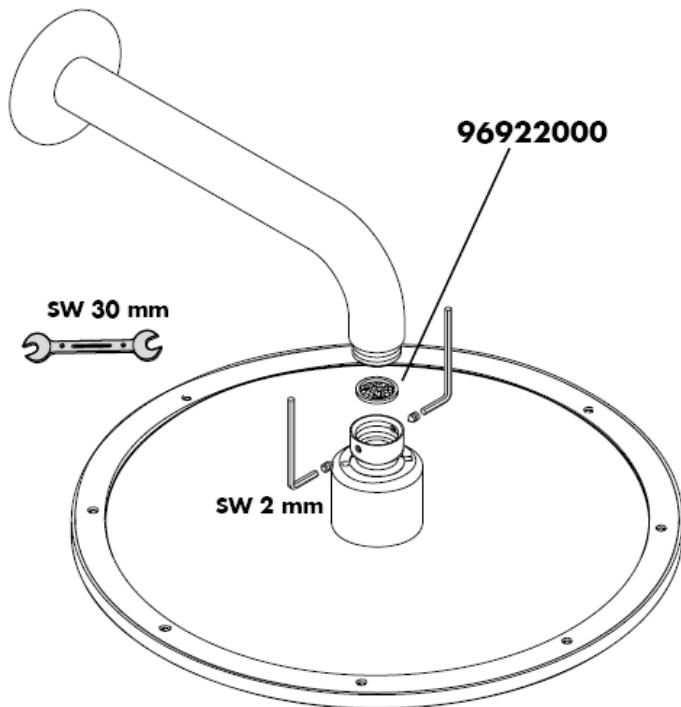

Montáž

Pozor! Batéria sa musí montovať, preplachovať a testovať podľa platných noriem!

Nastavenie

Ak sa v mieste odberu líši zmeraná teplota od teploty nastavenej na termostate, je nutné vykonať korekciu.

Postupuje sa takto: Otáčajte rukoväťou so stupnicou, pokiaľ dosiahne teplota vody v mieste odberu 38 °C. Uvoľnite skrutku rukoväte, rukoväť stiahnite a natočte ju do polohy pre 38 °C. Rukoväť nasuňte späť a dotiahnite skrutku rukoväte (viď strana 22).

Obmedzenie teploty

Rozsah teplôt je bezpečnostnou poistkou obmedzený na 38 °C. Pokiaľ sa požaduje vyššia teplota, je možné prekonať bezpečnostnú poistku stlačením červeného tlačidla.

Safety Function

Vďaka Safety Function je možné vopred nastaviť najvyššiu požadovanú teplotu, napr. max. 42 °C. viď strana 21.

Technické údaje

Prevádzkový tlak: max. 1 MPa
Doporučený prevádzkový tlak: 0,1 – 0,5 MPa
Skúšobný tlak: 1,6 MPa
(1 MPa = 10 bar = 147 PSI)
Teplota teplej vody: max. 80 °C
Doporučená teplota teplej vody: 65 °C
Prietok: ca. 58 l/min 0,3 MPa

Údržba

Termostatické batérie nevyžadujú žiadnu zvláštnu údržbu. Pri spätných ventiloch sa musí podľa DIN EN 1717 v súlade s národnými alebo regionálnymi predpismi testovať ich funkčnosť (aspoň raz ročne). Skontrolujte pri tejto príležitosti aj lapače nečistôt, ktoré sa nachádzajú na MTC regulačnej jednotke (6.1). Po montáži MTC regulačnej jednotky (6) skontrolujte bezpodmienečne teplotu na výtoku, ako je popísané v bode „Nastavenie“. Predtým rozhodne skontrolujte, či je zapnuté zásobovanie teplou vodou a či je v mieste odberu voda s maximálnou teplotou k dispozícii.

Aby bol zaistený ľahký chod regulačnej jednotky, mal by sa termostat z času čas nastaviť na maximálne horúcu a maximálne studenú vodu.

Servisné diely viď strana 3

1	rukoväť termostatu	38391000
2	ružica	96452000
3	objímka	97439000
4	Nosné skrutky	96454000
5	Nosná rozeta	96447000
6	regulačná jednotka teplot	96633000
7	Filtračná sieťka	97367000
8	obmedzovač spätného nasatia	96655000
9	Predĺženie 25 mm	13595000
10	Predĺženie 25 mm	13596000

Slovensky

Porucha	Príčina	Pomoc
Málo vody	-Nízky tlak v prívode. -Zanesený lapač nečistôt v regulačnej jednotke -Sitko v tesnení sprchy je znečistené	-Skontrolovať tlak v potrubí -Vyčistiť sitká lapačov nečistôt -Vyčistiť sitko tesnení medzi sprchou a hadicou
Kríženie tokov, teplá voda sa pri uzavretej armatúre tlačí do prívodu studenej alebo naopak	-Znečistený alebo netesný spätný ventil	-Vymeniť obmedzovač spätného nasatia
Teplota na výtoku nesúhlasí s nastavenou teplotou	-Nebol nastavený termostat -Nízka teplota teplej vody	-Nastaviť termostat -Teplotu teplej vody zvýšiť na 42 C až 65 C
Nie je možné regulovať teplotu	-Regulačná jednotka teploty znečistená alebo zanesená vodným kameňom. -Funkčný blok zabudovať o 180	-Pri novej inštalácii: naopak pripojené základné teleso (má byť studená vpravo, teplá vľavo) alebo zabudované otočené o 180 -Tlačidlo bezpečnostnej poistky je nefunkčné
Vadná pružina	-Pružinu alebo tlačidlo vyčistiť a zľahka potrieť tukom, prípadne vymeniť -Tlačidlo zanesené vodným kameňom	-Pružinu alebo tlačidlo vyčistiť a zľahka potrieť tukom, prípadne vymeniť -Pružinu alebo tlačidlo vyčistiť a zľahka potrieť tukom, prípadne vymeniť

Osvedčenie o skúške

	P-IX	DVGW	SVGW	WRSA	KIWA	ACS	NF
27070000						X	
27418XXX							
28420000						X	
28435XXX						X	

Čištění

Jednoducho čistý: Vodný kameň sa dá zo štetín celkom ľahko odstrániť.

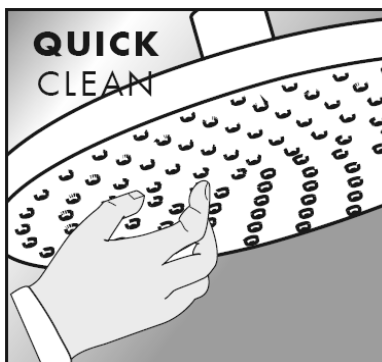

Návod na čistenie

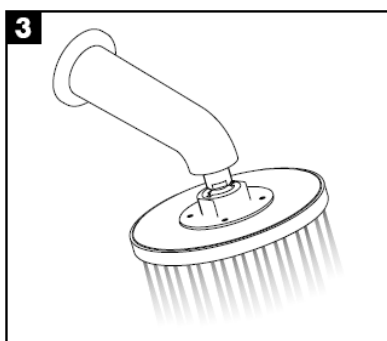
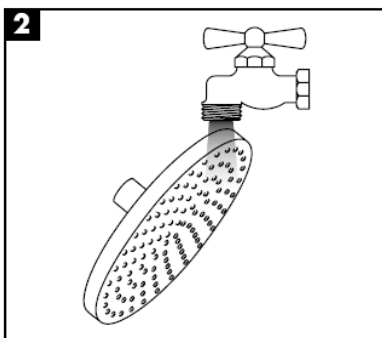
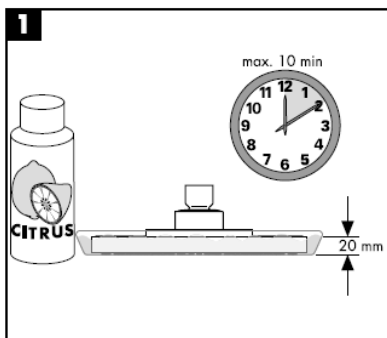

hansgrohe

Hansgrohe · Postfach 1145 · D-77761 Schiltach · Telefon +49 (0) 78 36/51-1282 · Telefax +49 (0) 7836/511440
E-Mail: info@hansgrohe.com · Internet: www.hansgrohe.com

07/2008
9.05170.04
Slovensky

组装说明



27418XXX

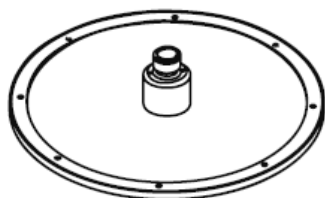

Raindance Royale AIR
28420000

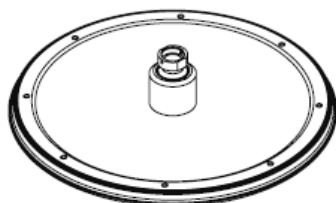

Raindance Royale Classic AIR
28435XXX

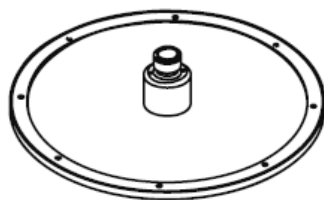

**Raindance Royale
High Flow Set**
27070000

hangrohe

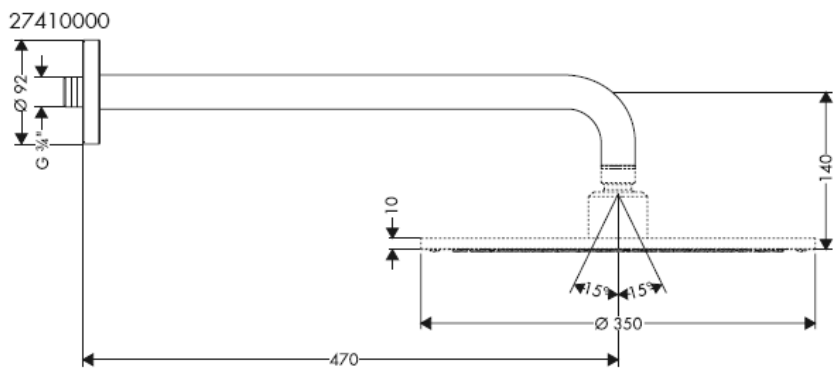
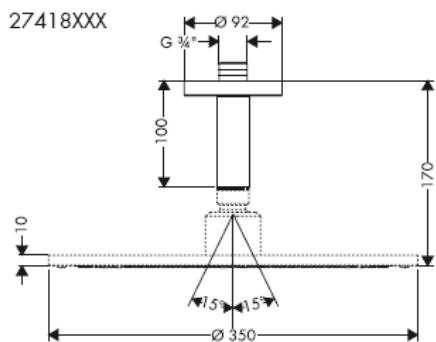
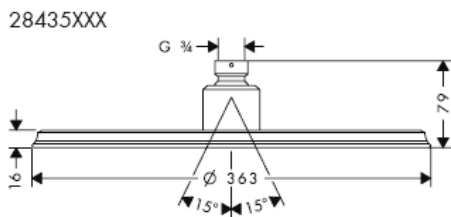
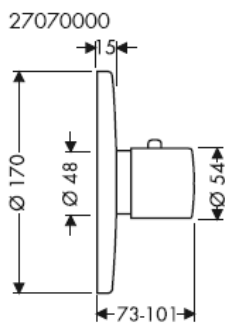
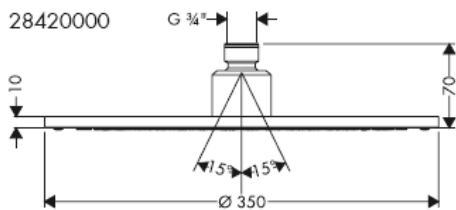

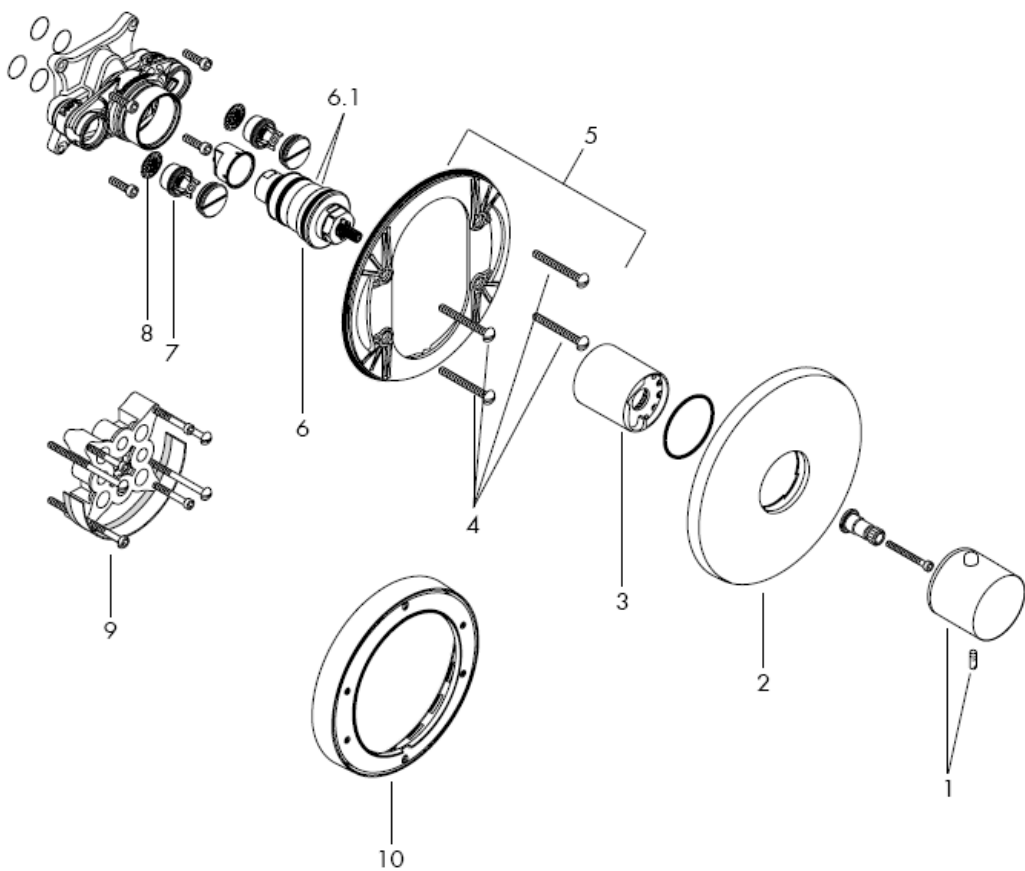

如果可能，可根据瓷砖方格调整尺寸。

对于加固边壁需要固定起泡臂

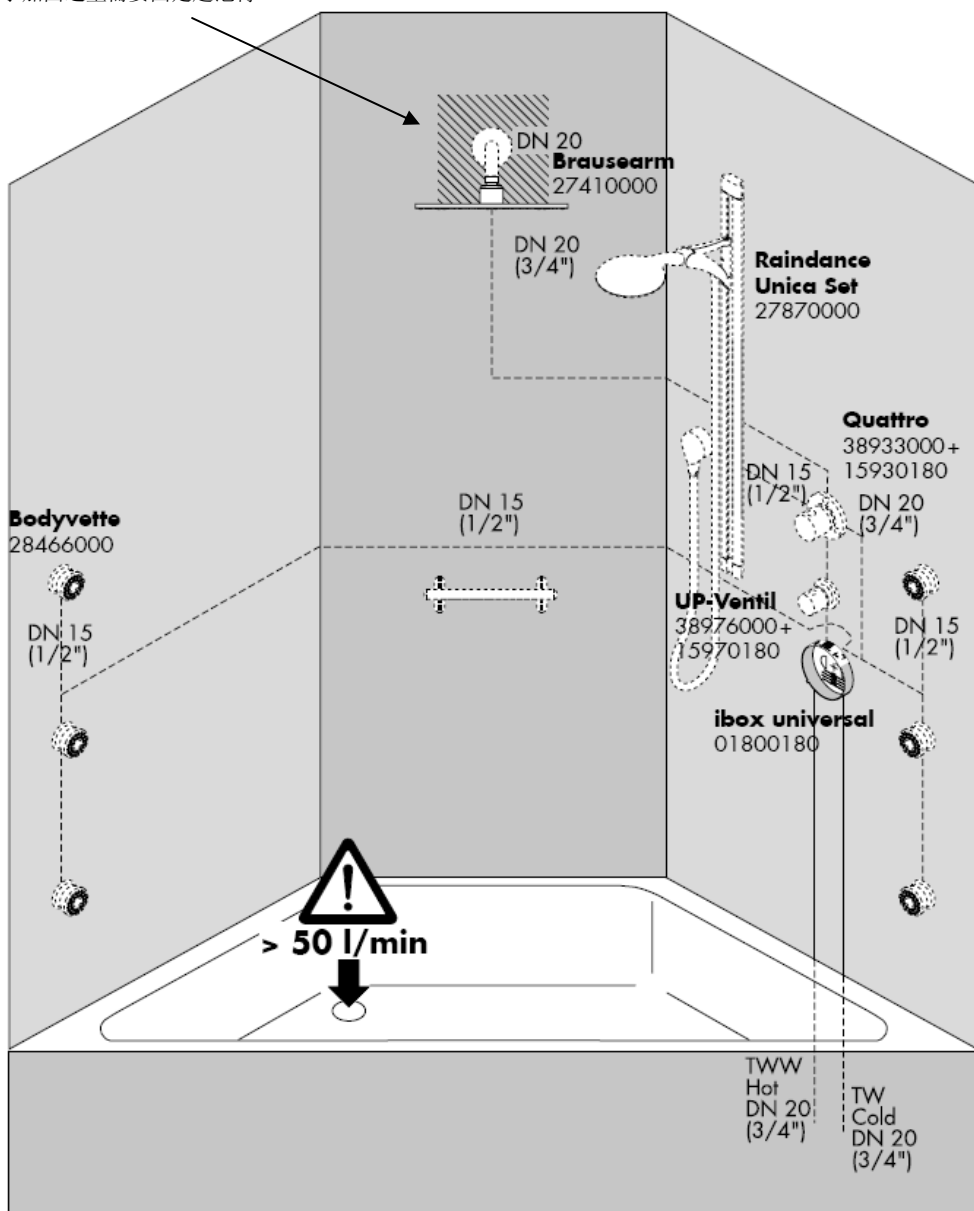

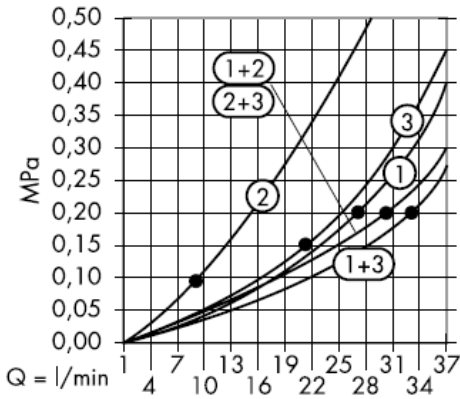

从•开始，正常功能得以保证。

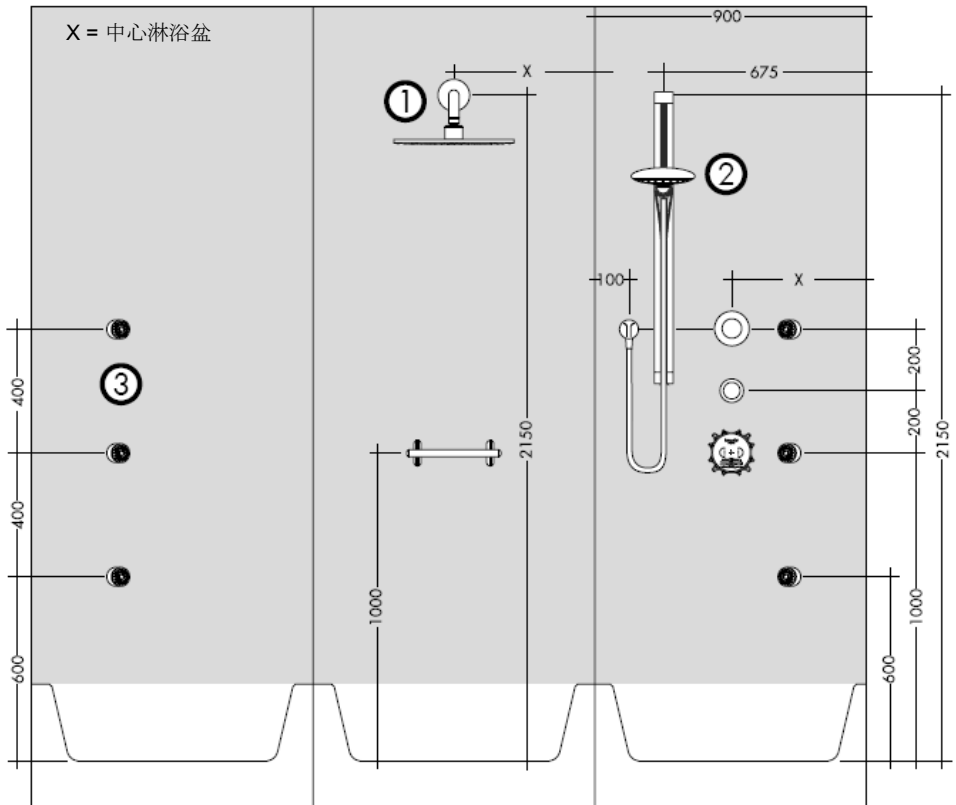

对于加固边壁需要固定起泡臂

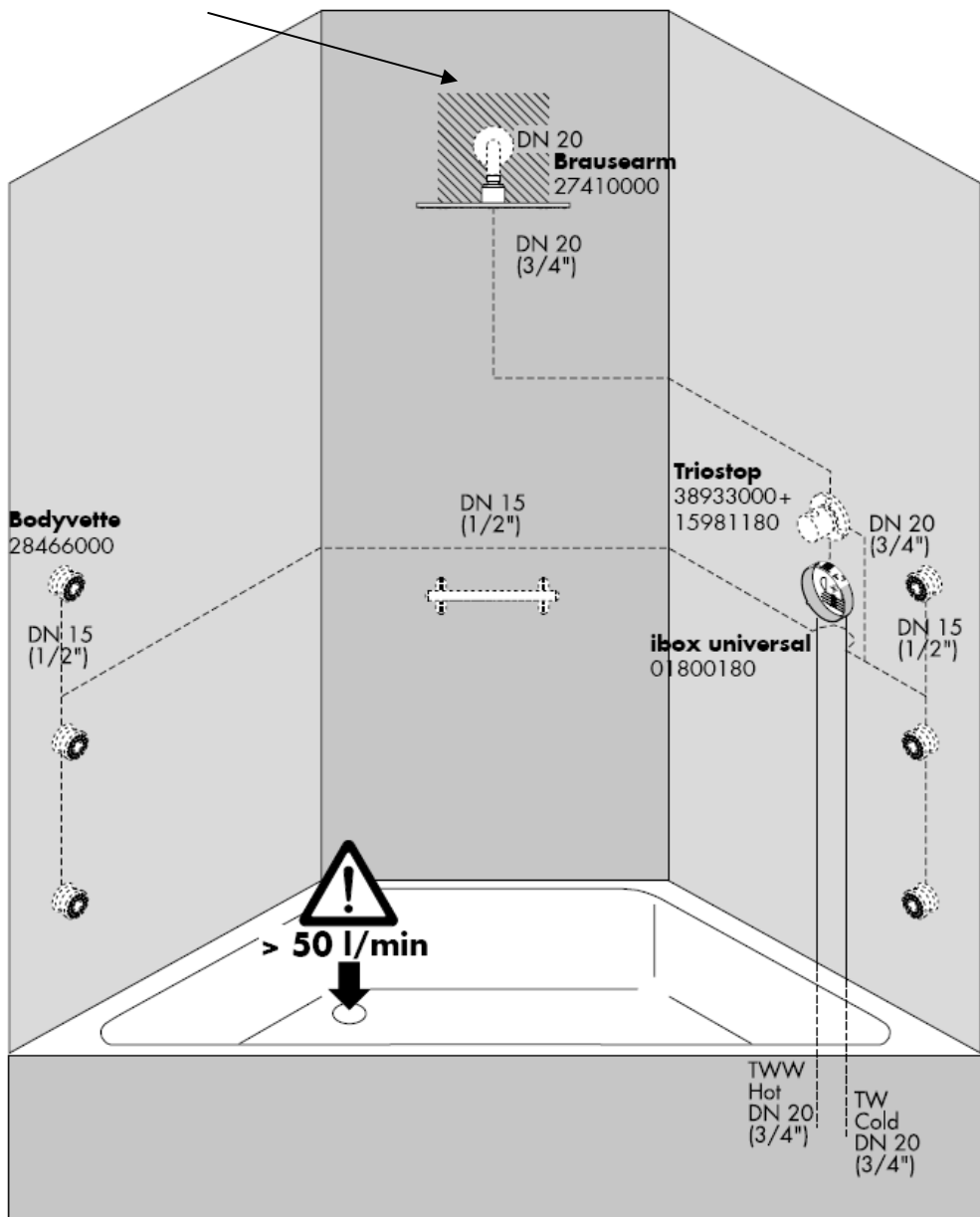

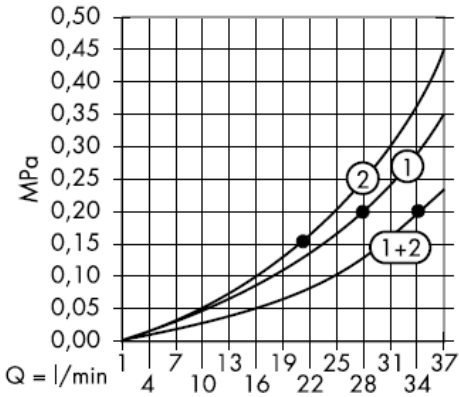

从•开始，正常功能得以保证。

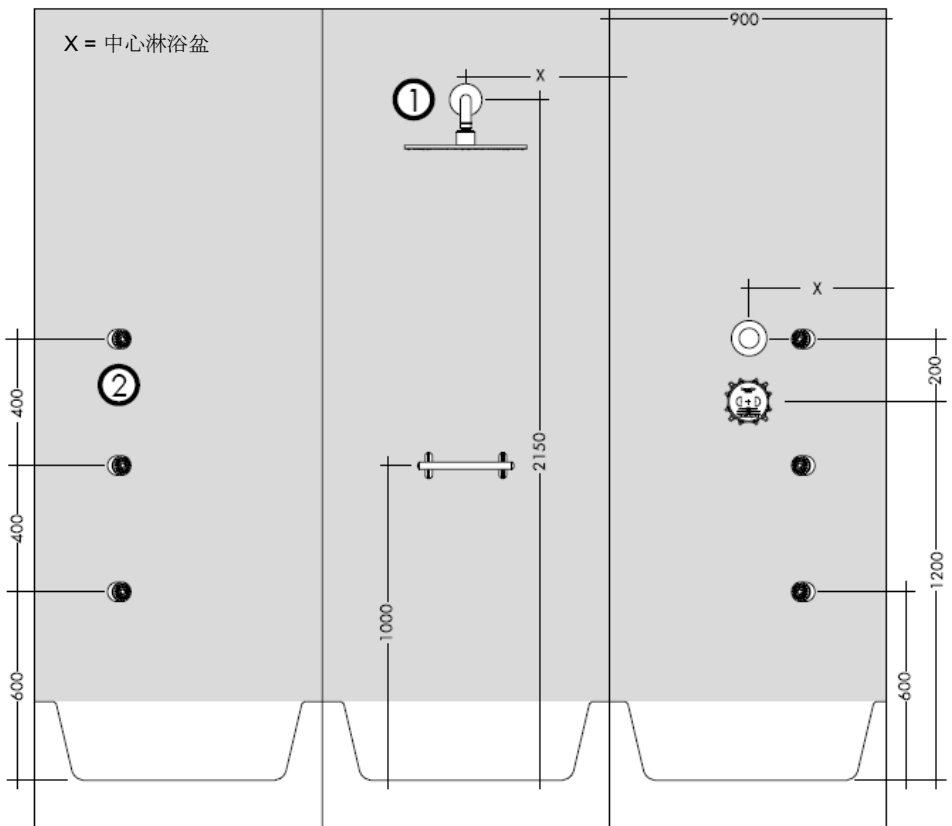

对于加固边壁需要固定起泡臂

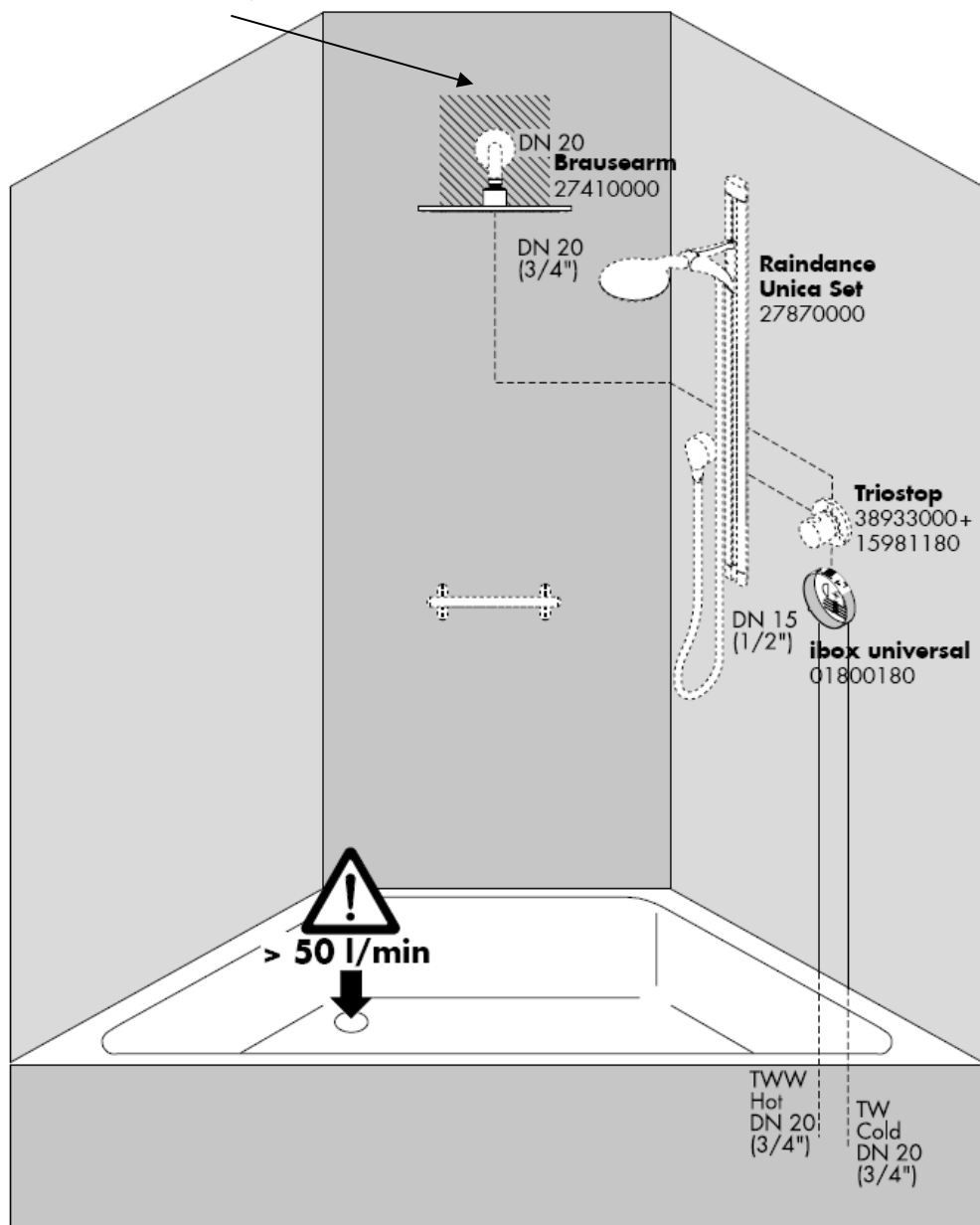

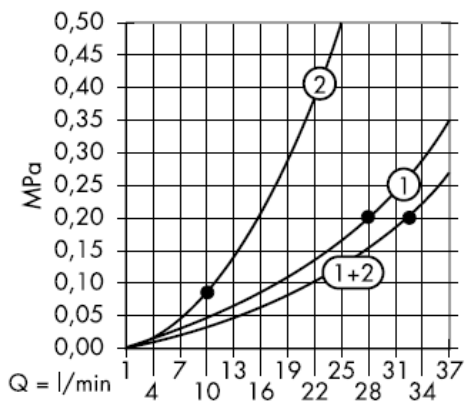

从•开始，正常功能得以保证。

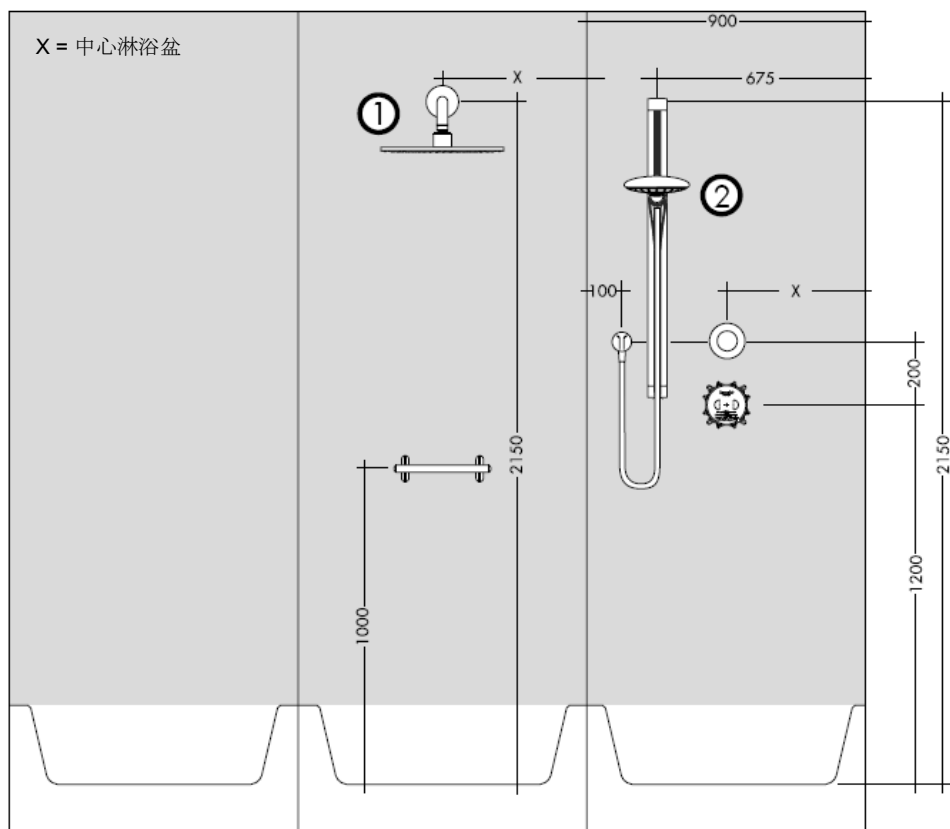

对于加固边壁需要固定起泡臂

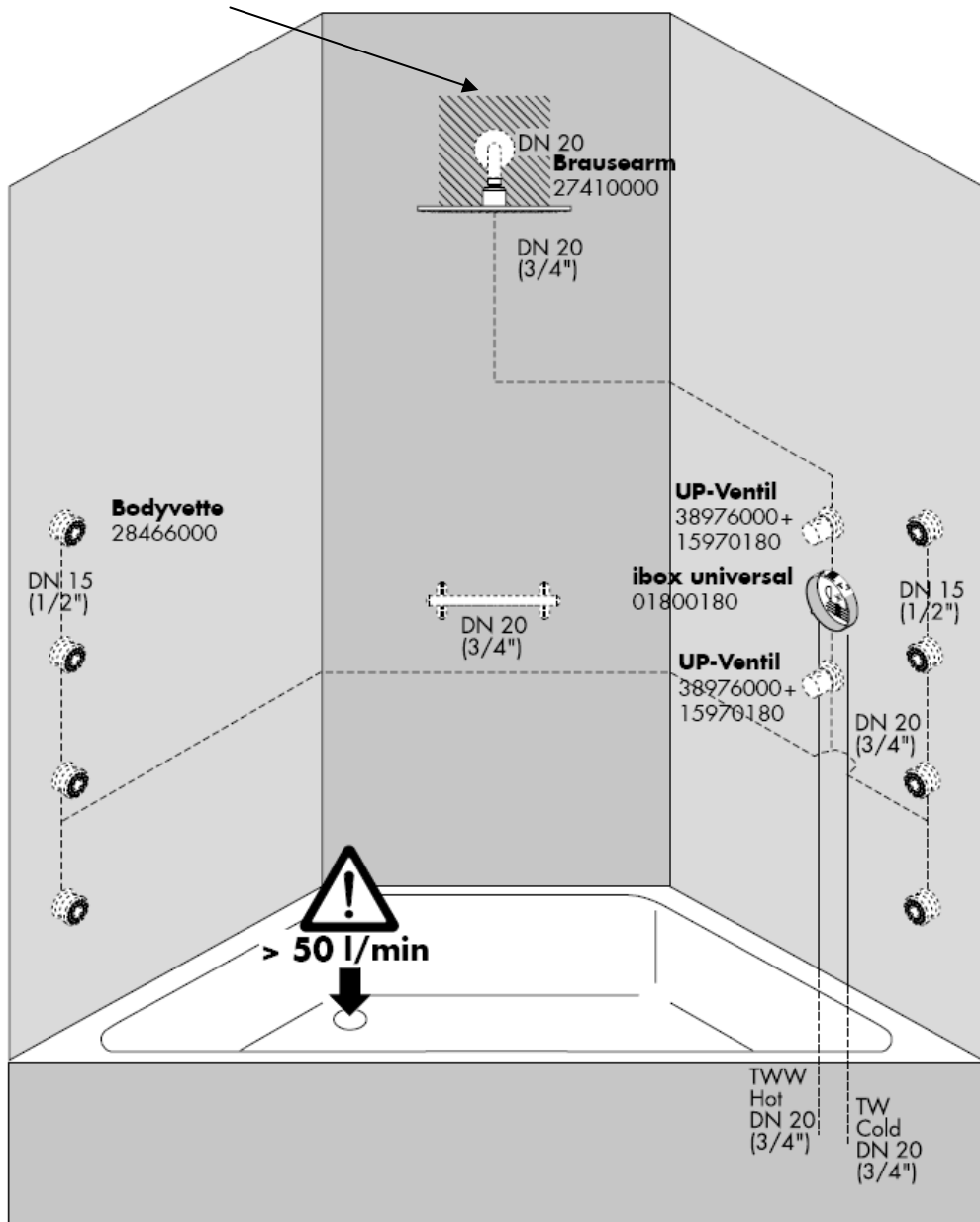

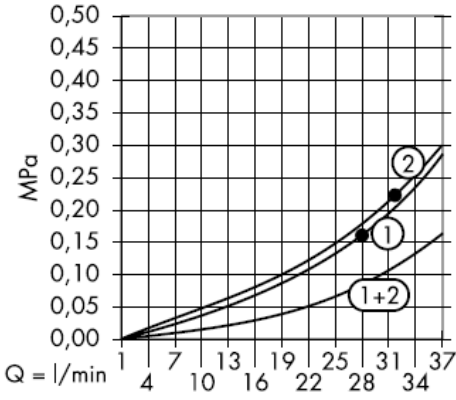

从•开始，正常功能得以保证。

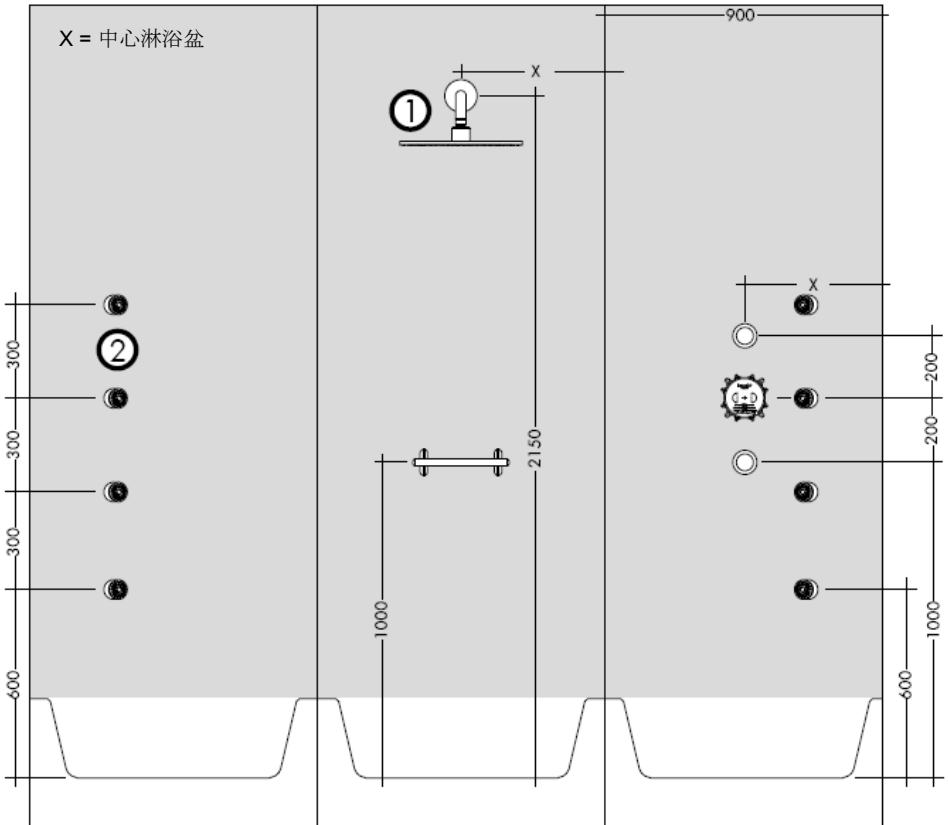

对于加固边壁需要固定起泡臂

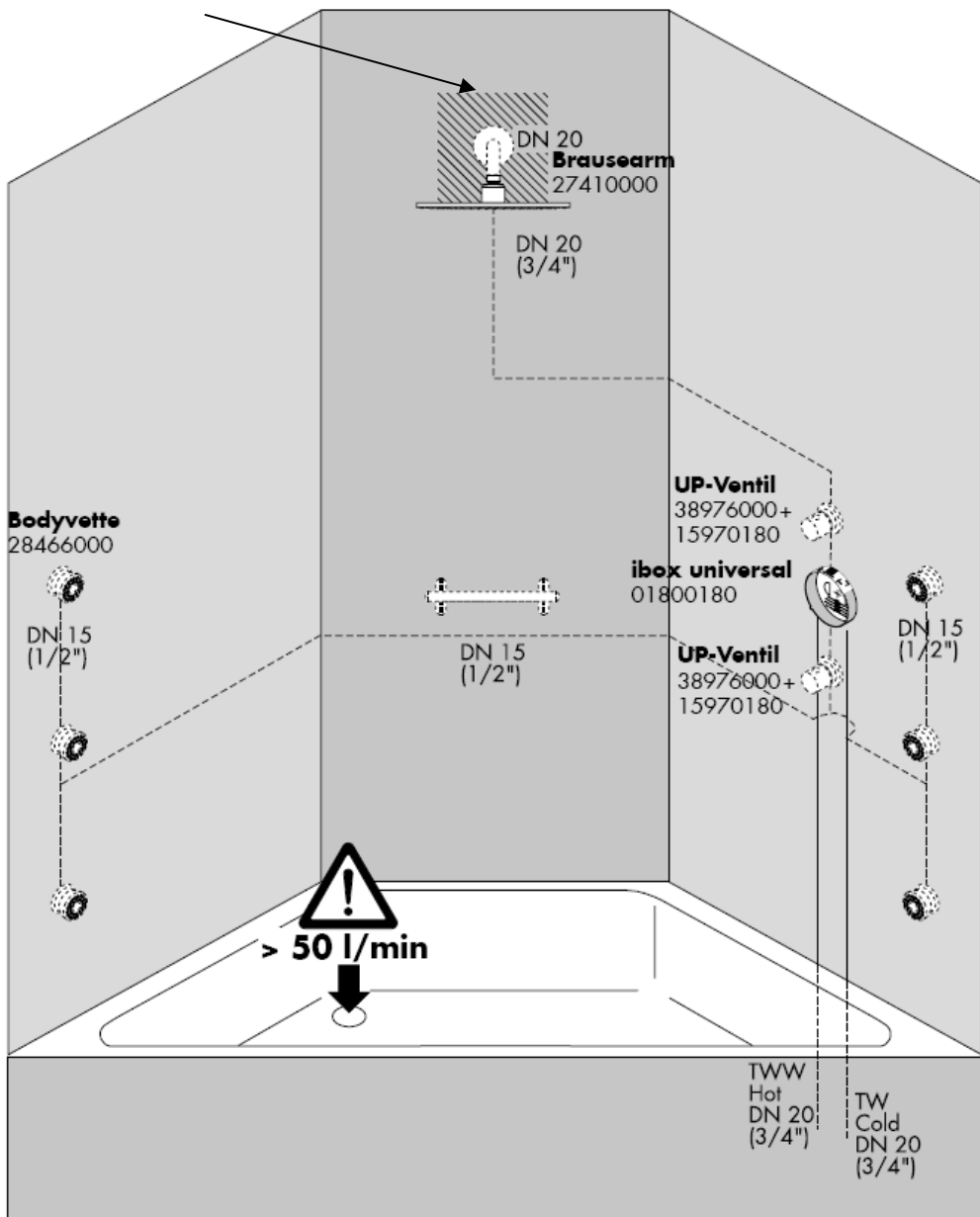

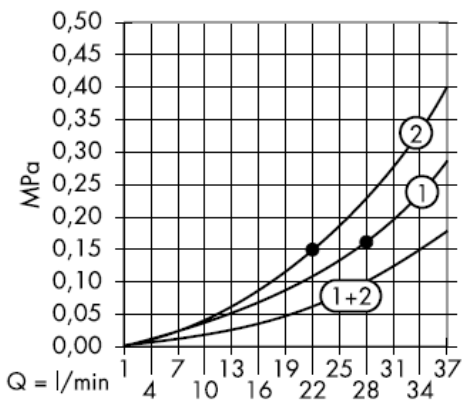

从•开始，正常功能得以保证。

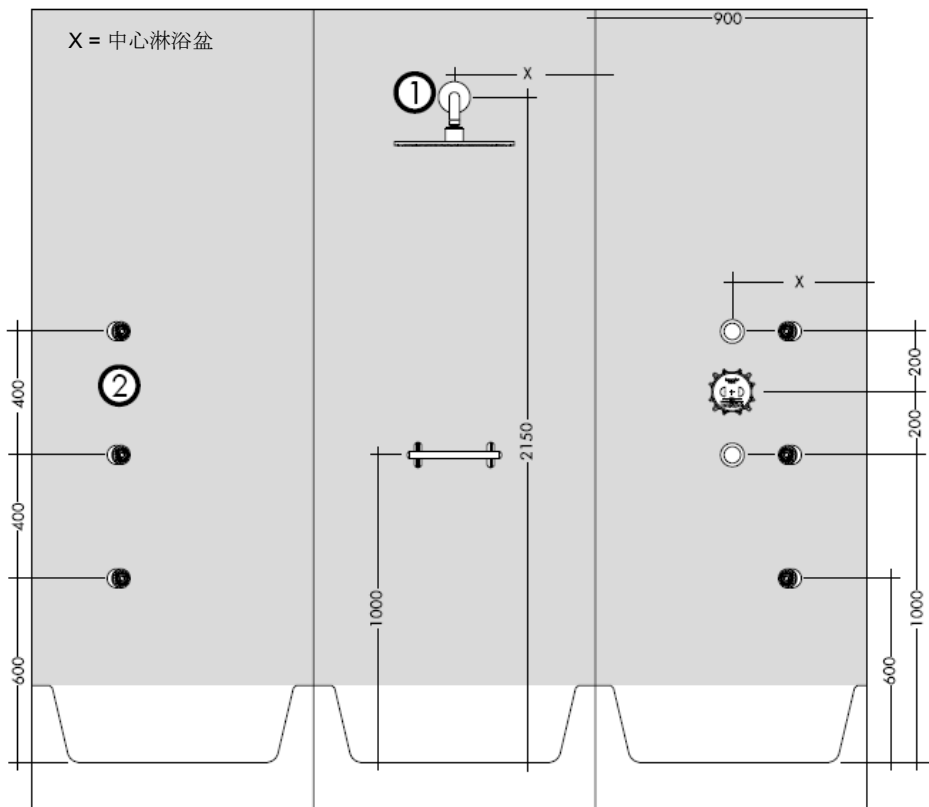

对于加固边壁需要固定起泡臂

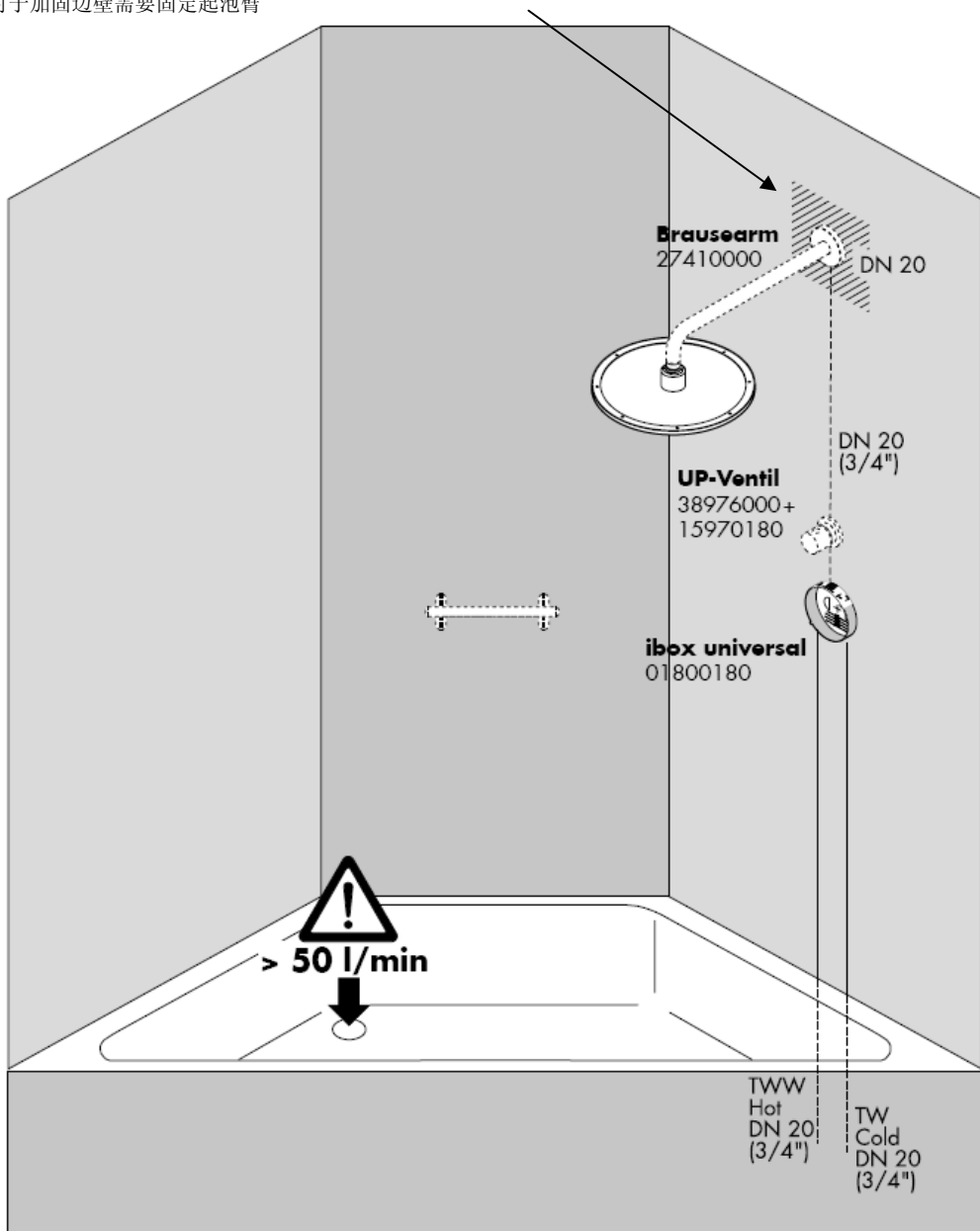

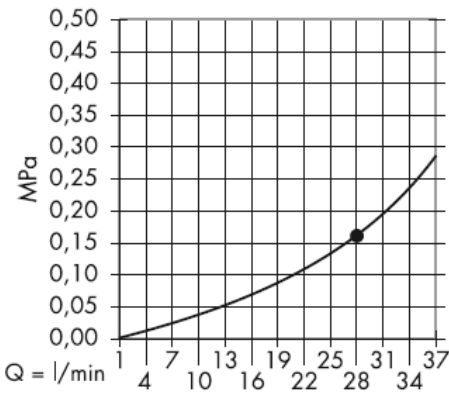

从•开始，正常功能得以保证。

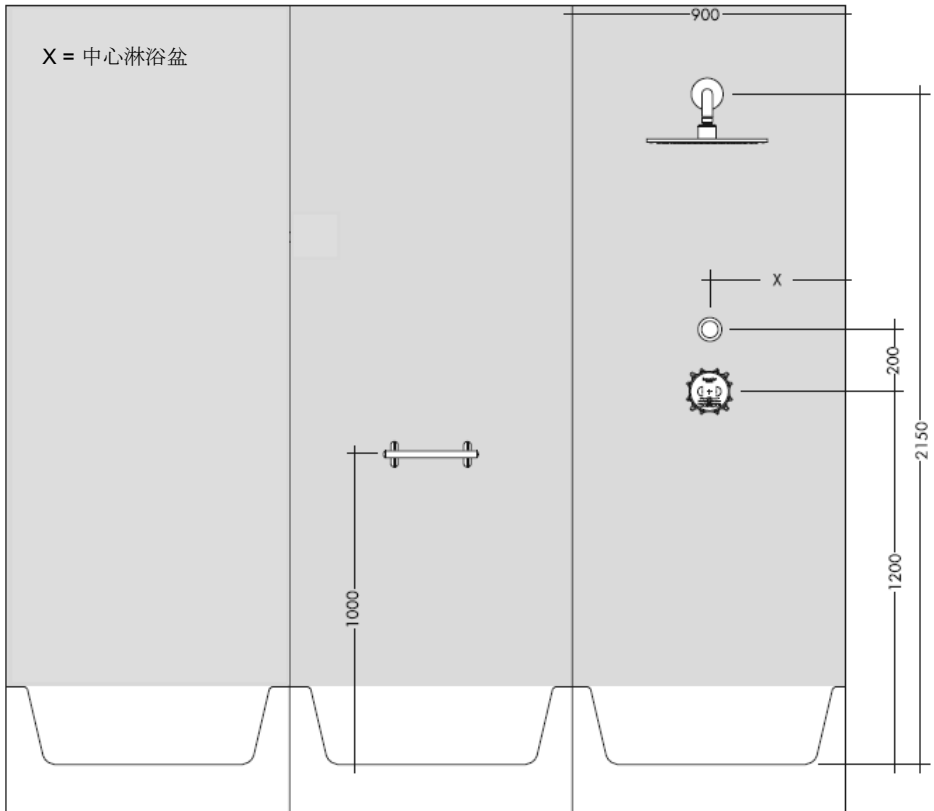

对于加固边壁需要固定起泡臂

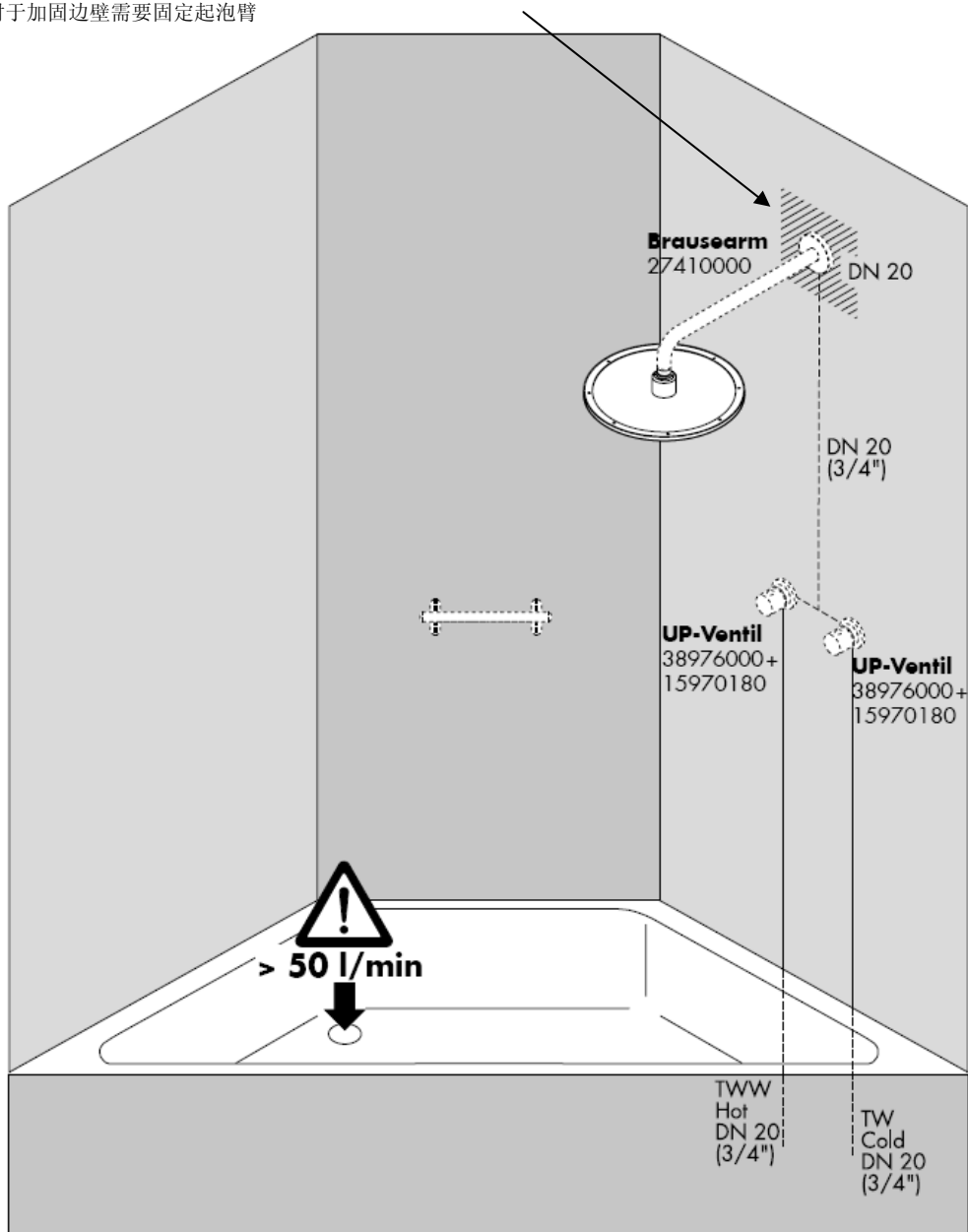

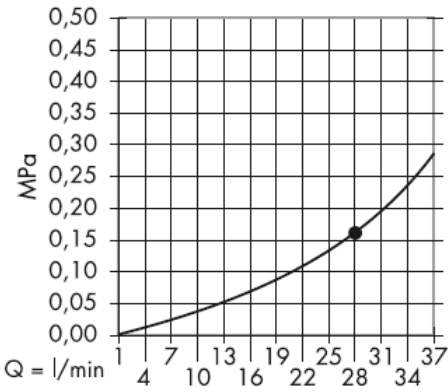

从•开始，正常功能得以保证。

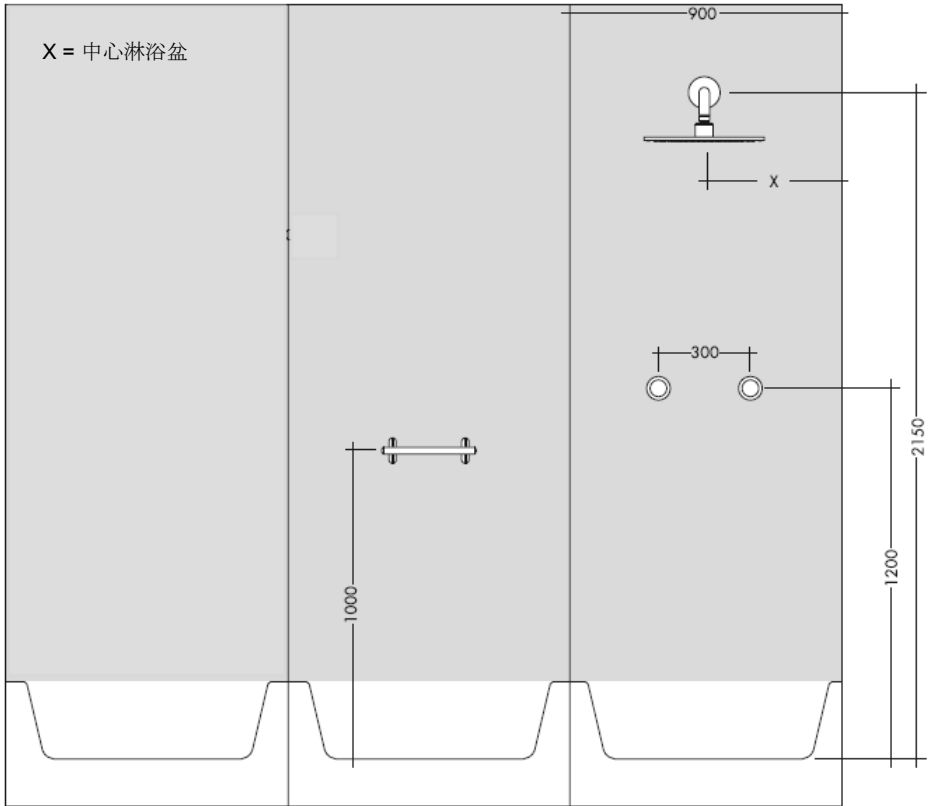

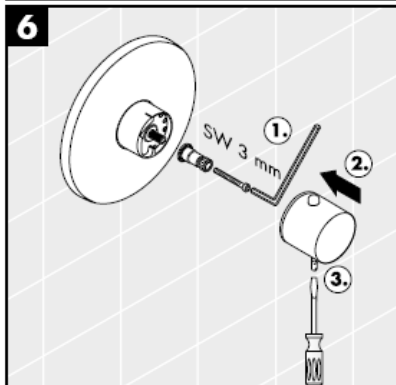
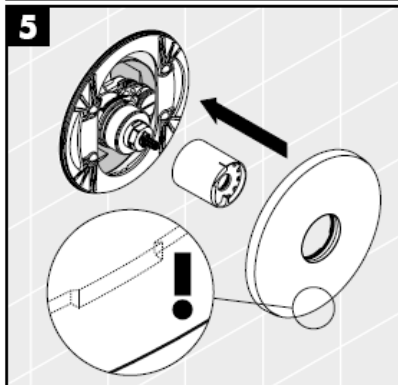
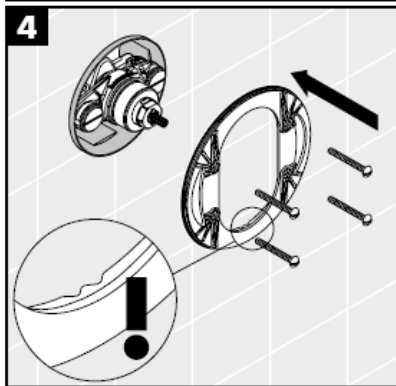
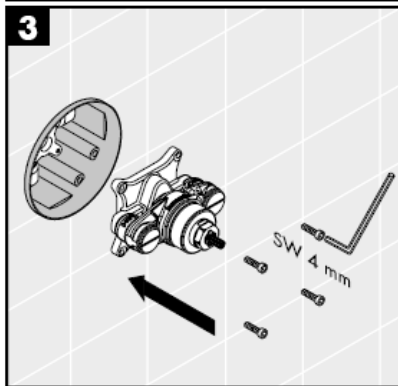
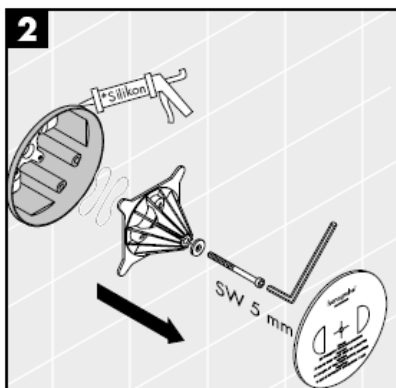
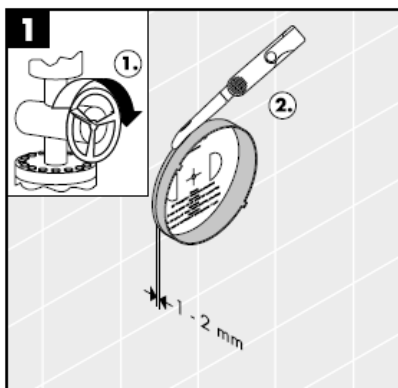

硅胶 (不含醋酸)

恒温阀芯的安全功能可以预先设定所希望的最高出水温度，例如最高温度为42℃

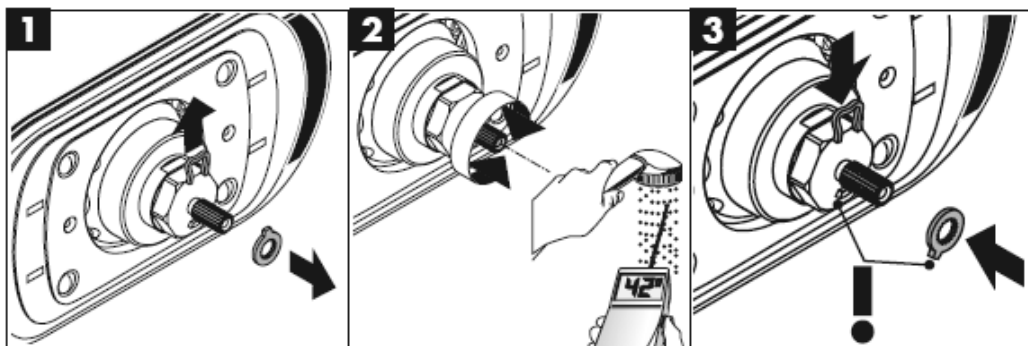

校准

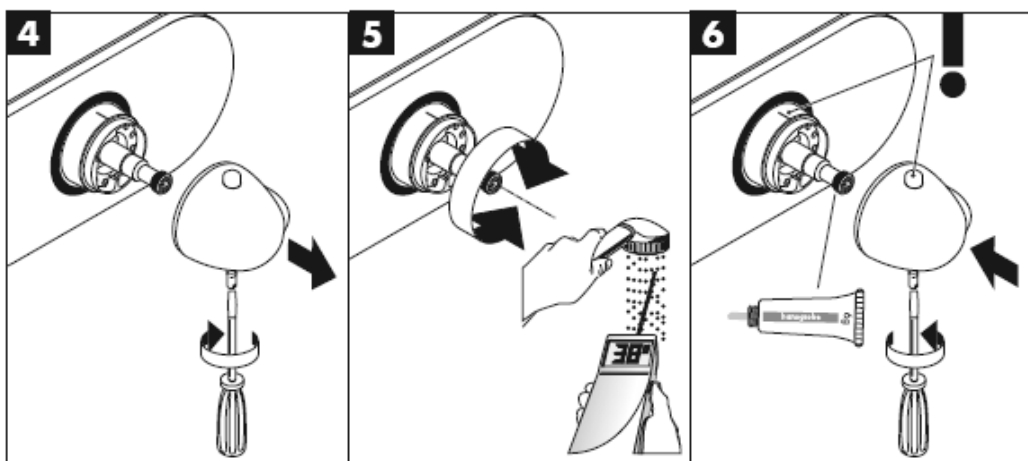



如果使用莲蓬头，则该莲蓬头连同莲蓬头臂一起重约为**10**千克。四周只使用适合于砖墙的固定材料！所附螺栓和膨胀螺栓只用于实心砖墙。

仅使用适合砌砖工程的紧固材料！所附的螺丝和销钉仅适用于实心砖。

废水管的性能必须具有充足的尺寸。

只有与汉斯格雅高流量自动调温器组合时，方担保最佳的性能。

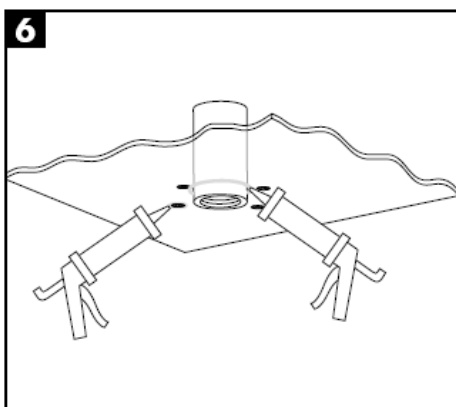
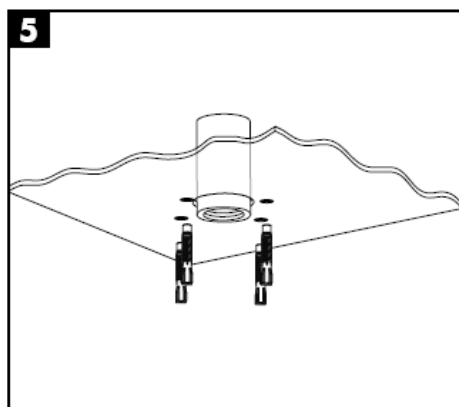
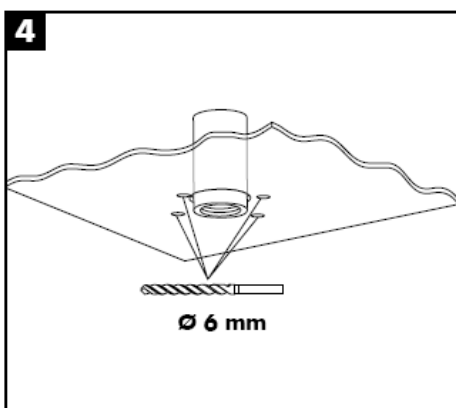
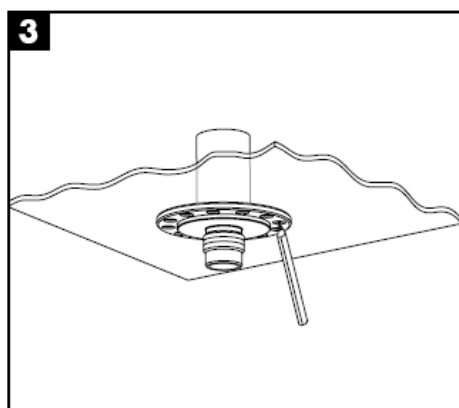
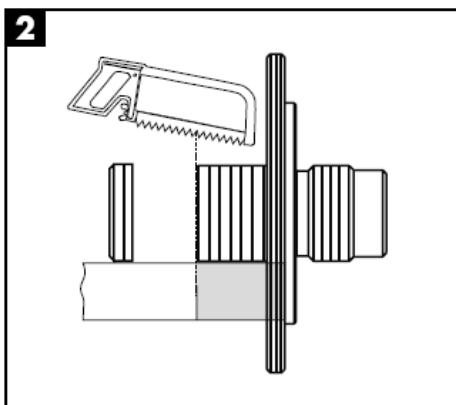
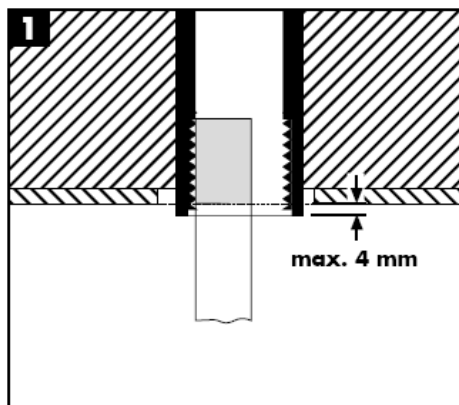

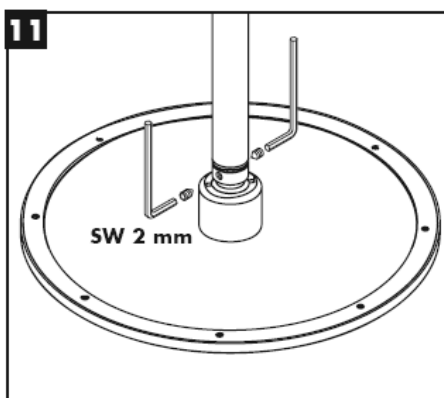
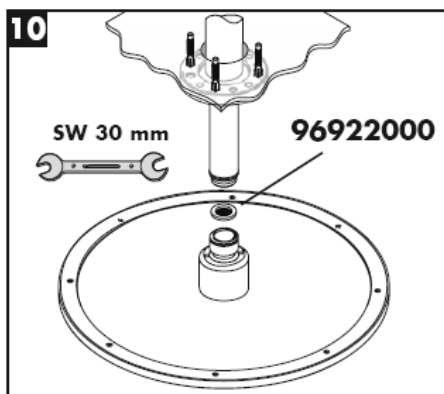
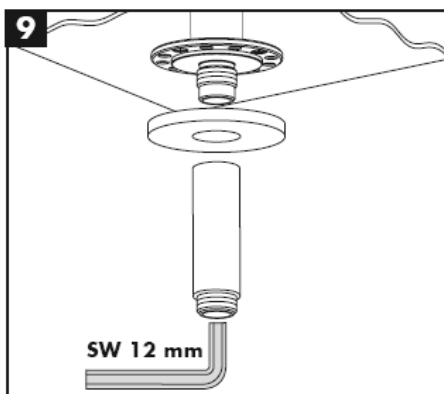
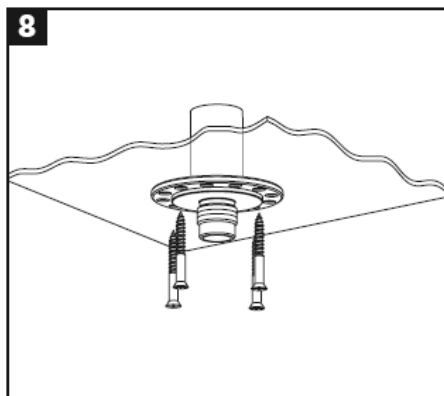
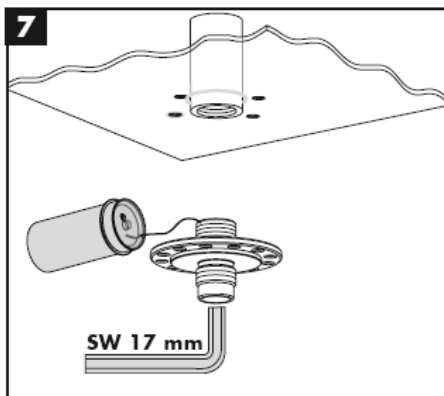

必须装上花洒所附带的滤网密封垫，以过滤管道里的杂质污物。杂质污物会影响花洒的功能和/或损坏花洒的功能部件，由此而产生的产品损坏不属于汉斯格雅的保修范围。

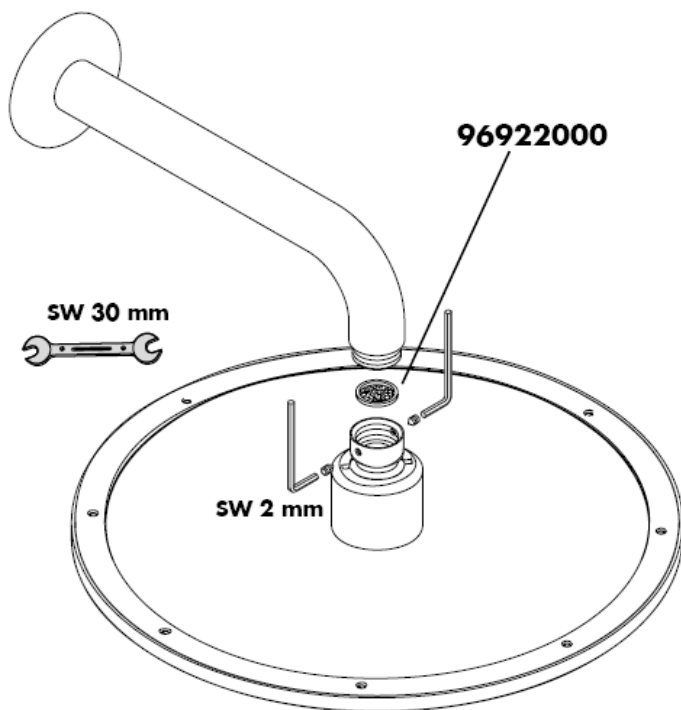

安装

注意！

必须按照现行的规定安装，冲洗和测试产品！

校准

如果在分出点测量的温度不同于标度尺上设定的温度，需要进行更正。调整温度的步骤如下：转动设定旋钮，直到 **38 C** 的水从出口流出。松开设定旋钮的螺丝。拆下设定旋钮，并转动到 **38 C** 的位置。再次安装设定旋钮，并上紧螺丝（请参见第22页）。

温度限制

出水温度由安全阀限制在**38 C**（防止烫伤）。

安全功能

恒温阀芯的安全功能可以预先设定所希望的最高出水温度，例如最高温度为**42°C** 参见第页 21.

技术参数

工作压力:	max. 1 MPa
推荐工作压力:	0,1 – 0,5 MPa
测试压强:	1,6 MPa
(1 MPa = 10 bar = 147 PSI)	
热水温度:	max.80° C
推荐热水温度:	65° C
流速:	ca.58 l/min 0,3 MPa

保养

恒温龙头没有特殊的保养方式。

单向阀必须在符合国家或当地的法律的情况下按照**DIN EN 1717**定期检查（至少一年一次）。在此情况下，请同时检查**MTC**恒温阀芯（17.1）上的过滤网。在安装**MTC**恒温阀芯（17）后，请务必在拿掉“调节器”的情况下检测水温。在调节时，请检查热水供水是否正常及热水能提供的最高温度。

为了保证恒温器的稳定运转，请务必定期从最热到最冷转动调温器。

备用零件 参见第页 3

1	调温器手柄	38391000
2	法兰	96452000
3	衬套	97439000
4	固定螺丝	96454000
5	底板	96447000
6	温差电偶	96633000
7	过滤网	97367000
8	单向阀	96655000
9	加长	13595000
10	加长	13596000

中文

问题	原因	补救
龙头出水量小	-水压不足 -调压器过滤网脏污 -花洒滤网有垃圾堵塞	-检查总水压 -清洗过滤网 -清洗花洒和软管间的过滤密封件
串水，在龙头关闭的状态下，热水被强迫流入冷水管路，或者相反。	-单向阀有垃圾堵塞或漏水	-更换单向阀
龙头出水温度和温度设定的不符	-恒温器未被调节 -热水温度过低	-调节恒温器 -将热水温度从42 C升高到65 C
水温无法调节	-温度调节器脏污或结垢 -安装功能块时，旋转180	-对于新的安装：基体连接不正确（可能是：右冷，左热）或者安装时旋转180 -安全停止按钮不工作
弹簧损坏	-清洁弹簧和/或按钮，并视需要更换 -按钮僵化	-清洁弹簧和/或按钮，并视需要更换 -清洁弹簧和/或按钮，并视需要更换

检验标记

	P-IX	DVGW	SVGW	WRSA	KIWA	ACS	NF
2707000						X	
27418XXX							
2842000						X	
28435XXX						X	

清洗

清洁：只需要揉搓花洒表面的出水孔即可去除水垢。

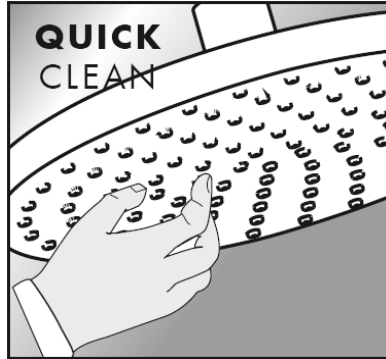

清洗说明

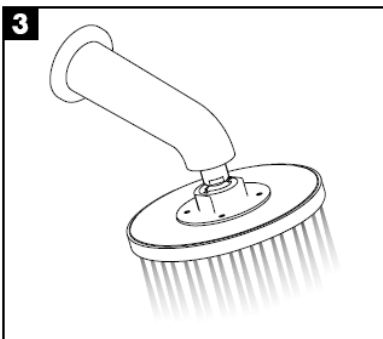
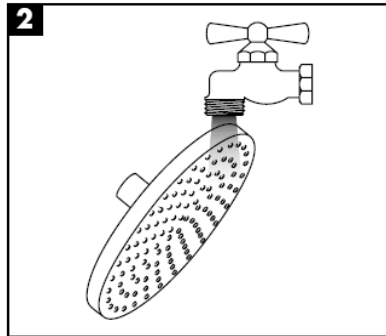
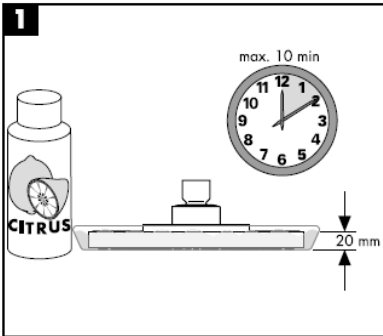

hansgrohe

Hansgrohe · Postfach 1145 · D-77761 Schiltach · Telefon +49 (0) 78 36/51-1282 · Telefax +49 (0) 7836/511440
E-Mail: info@hansgrohe.com · Internet: www.hansgrohe.com

07/2008
9.05170.04
中文

Инструкция по монтажу



27418XXX

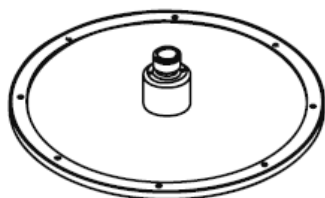

Raindance Royale AIR
28420000

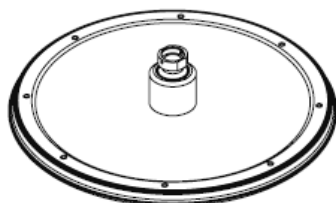

Raindance Royale Classic AIR
28435XXX

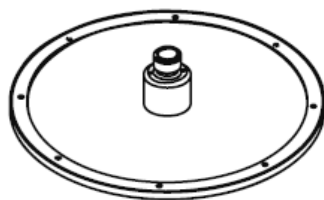

**Raindance Royale
High Flow Set**
27070000

hansgrohe

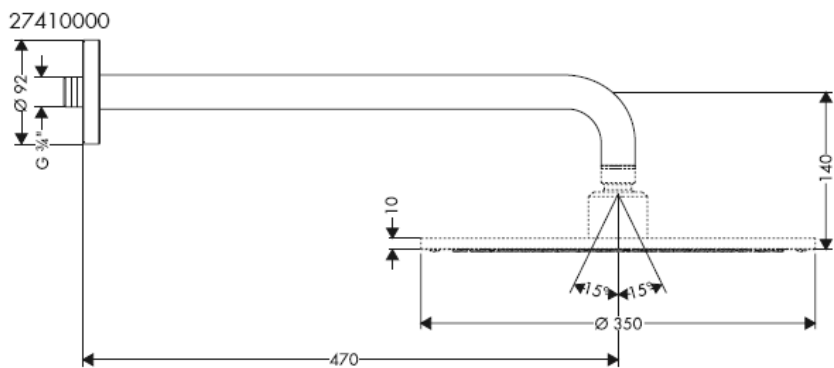
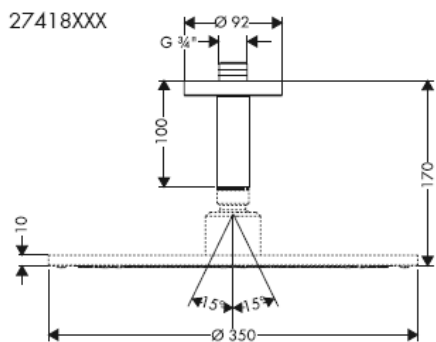
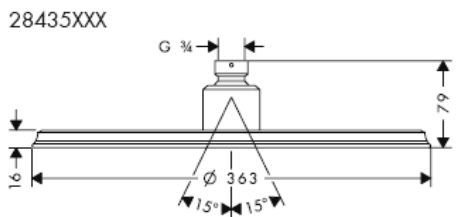
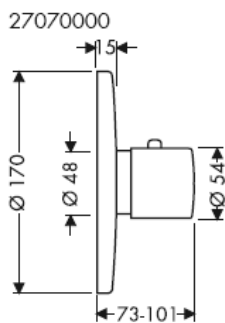
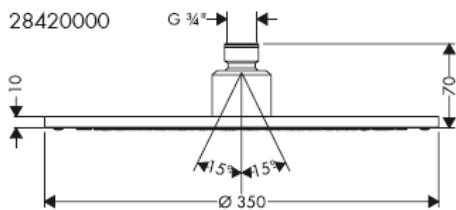

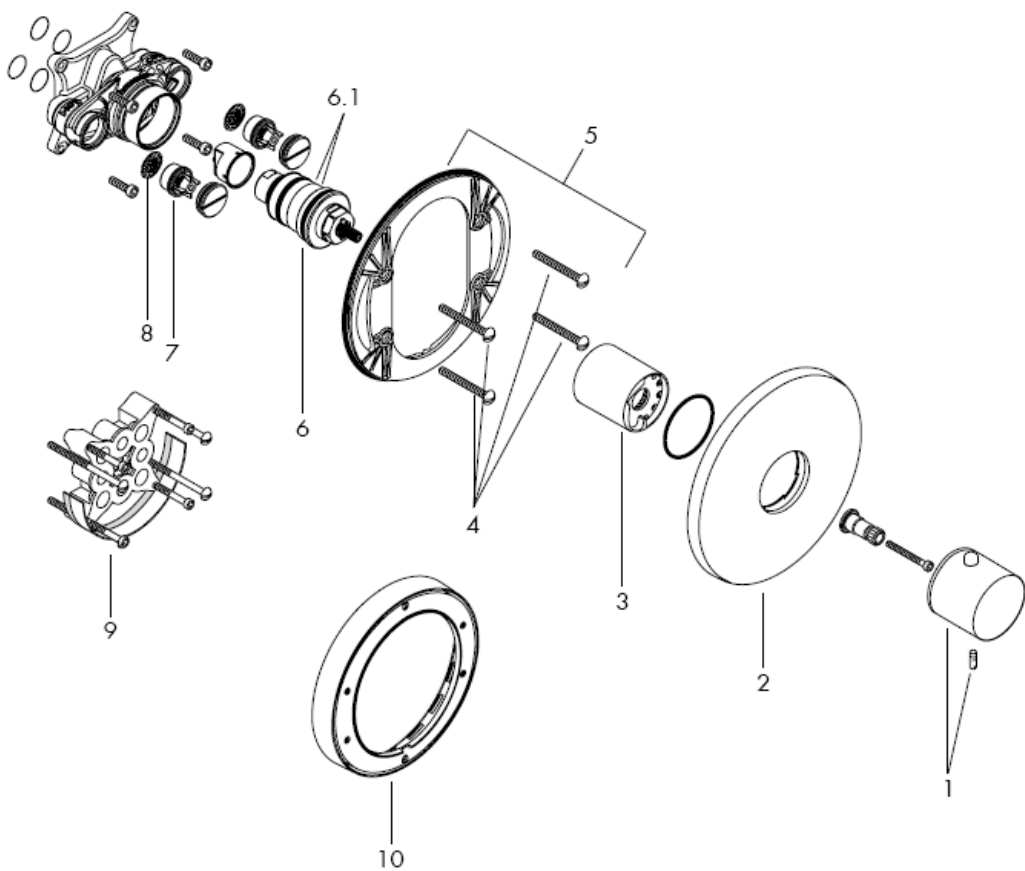

При определении внешних размеров при монтаже старайтесь по возможности учитывать расположение кафельной плитки.

необходимо усиление стены для крепления душевой сетки

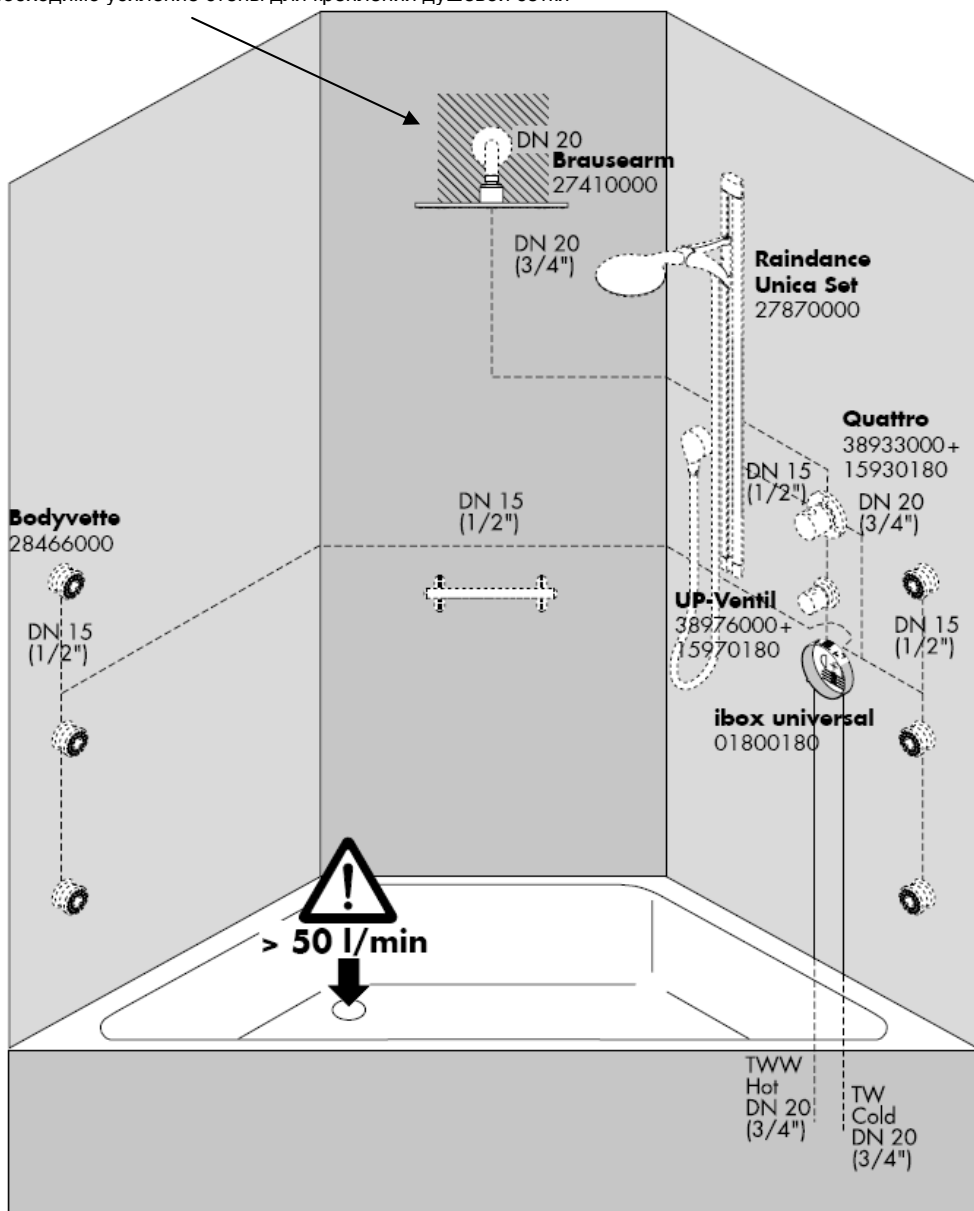

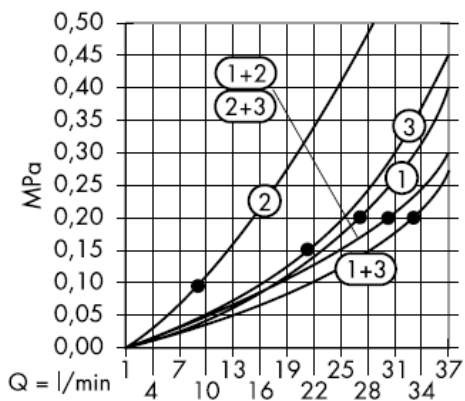

Гарантированное функционирование при показателях свыше *

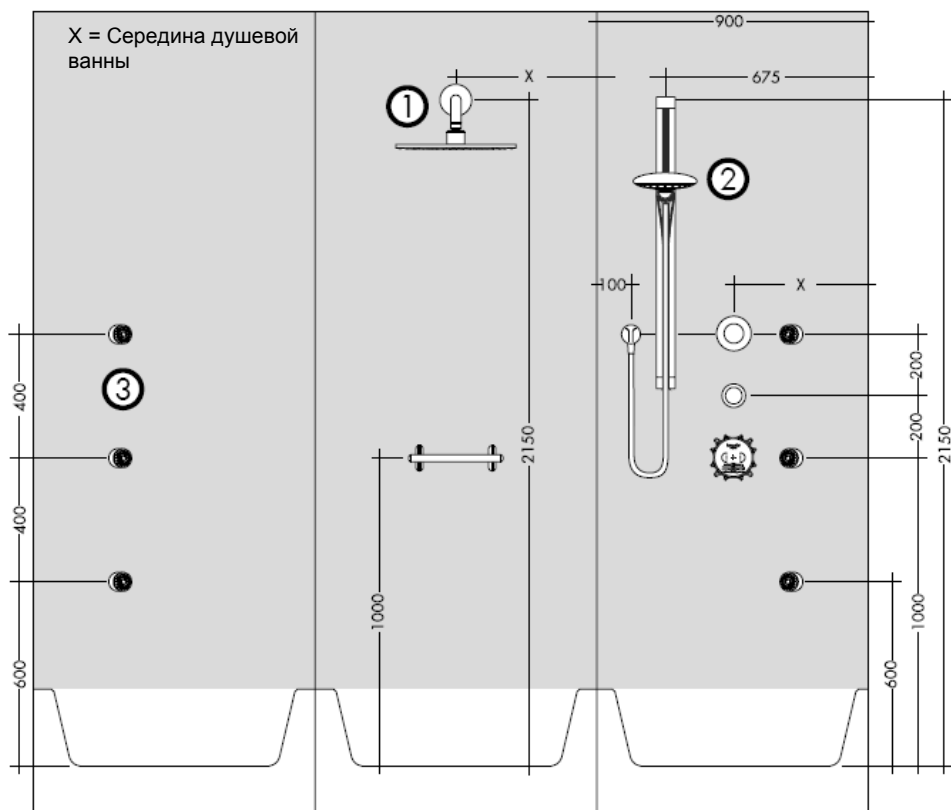

необходимо усиление стены для крепления душевой сетки

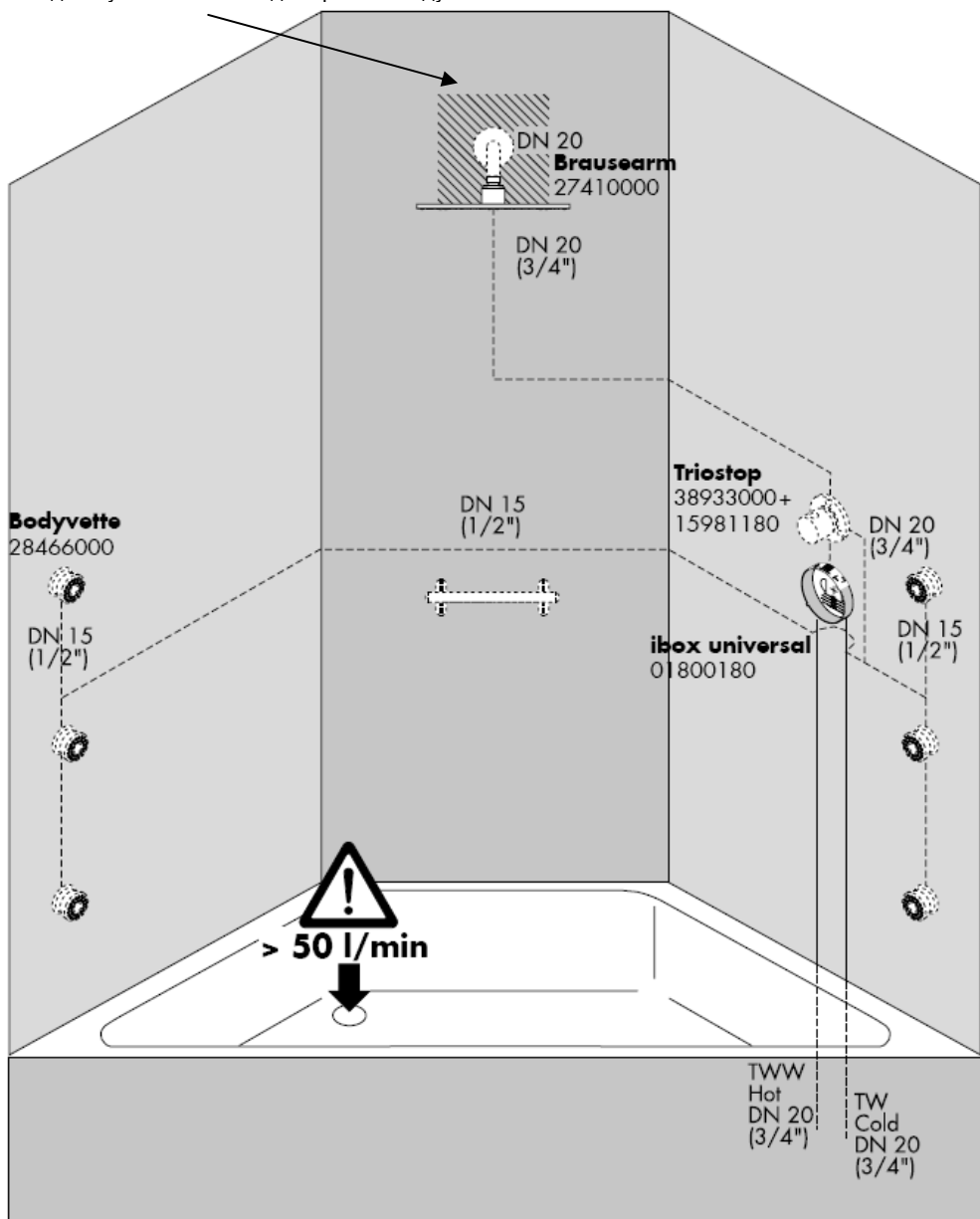

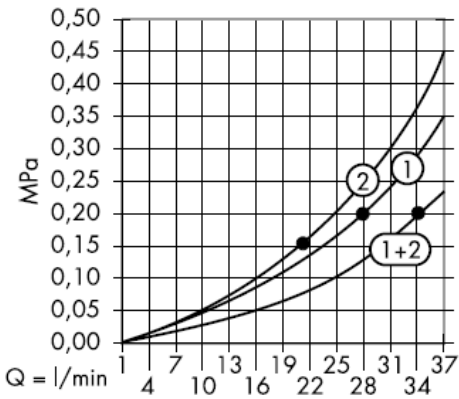

Гарантированное функционирование при показателях выше •.

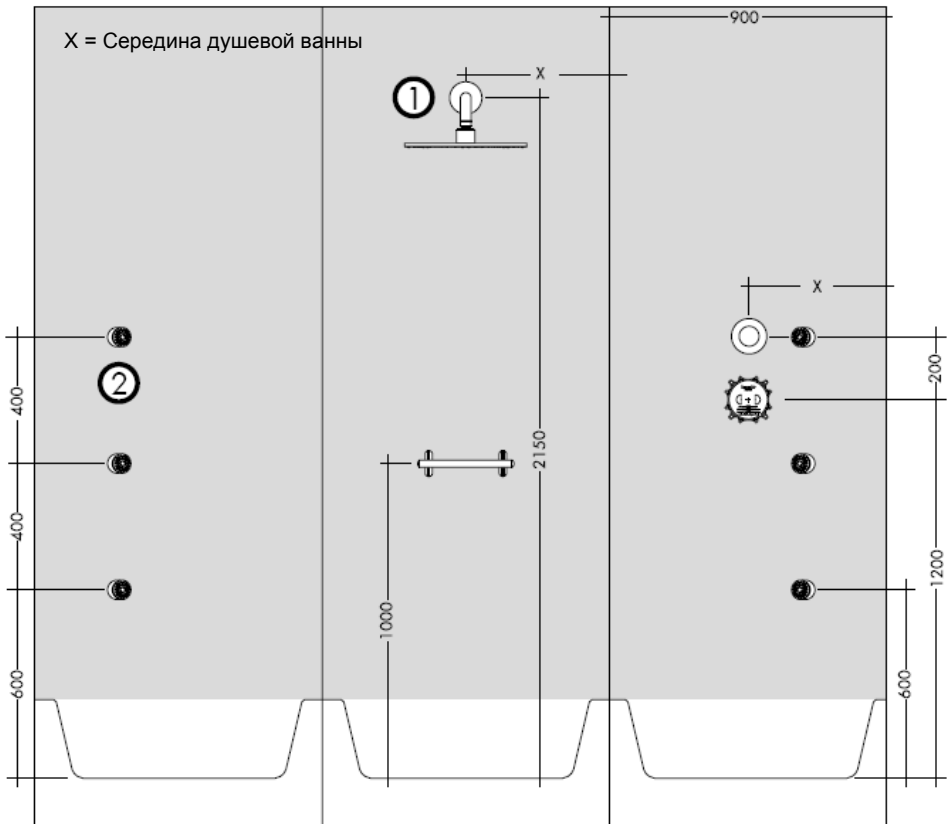

необходимо усиление стены для крепления душевой сетки

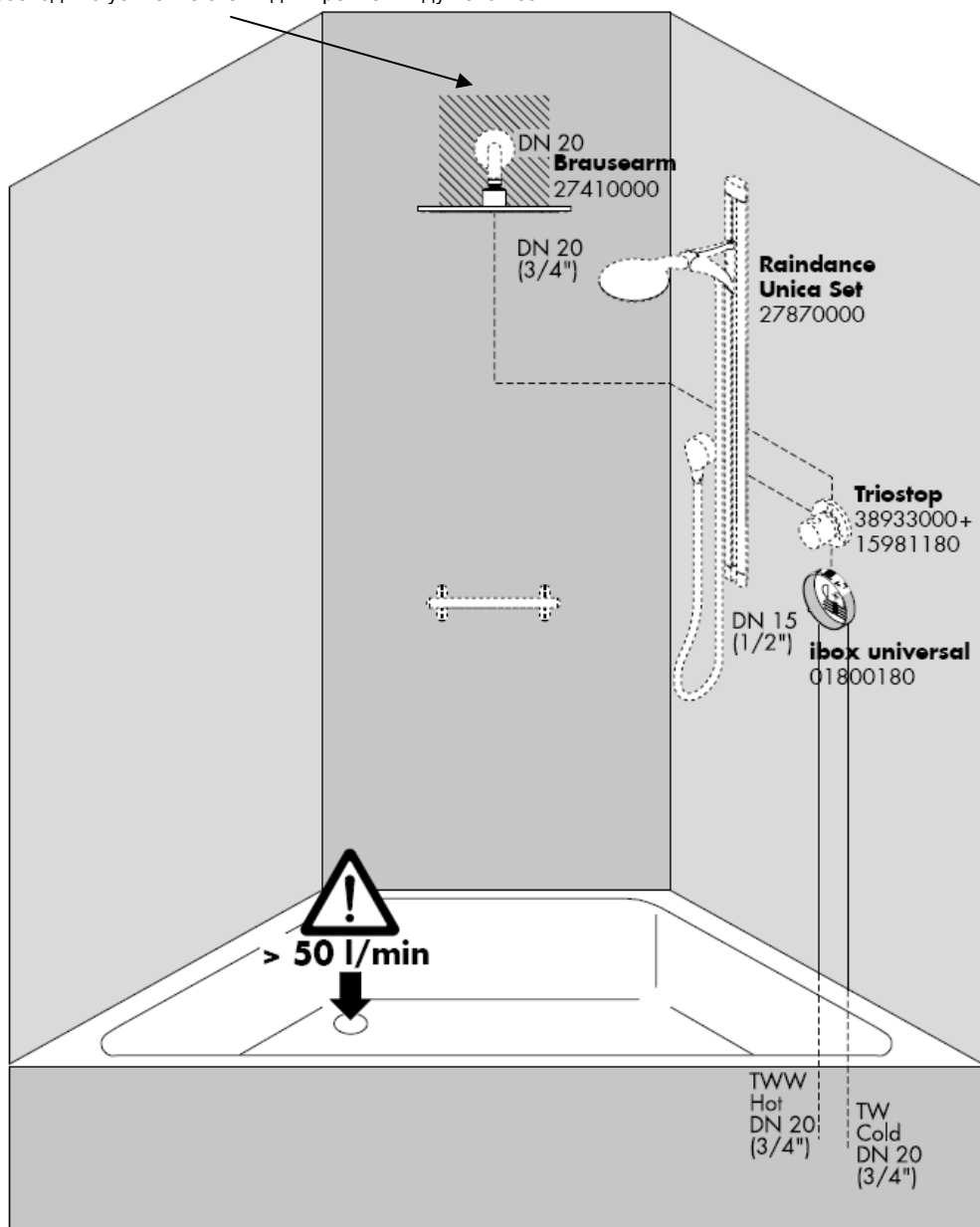

необходимо усиление стены для крепления душевой сетки

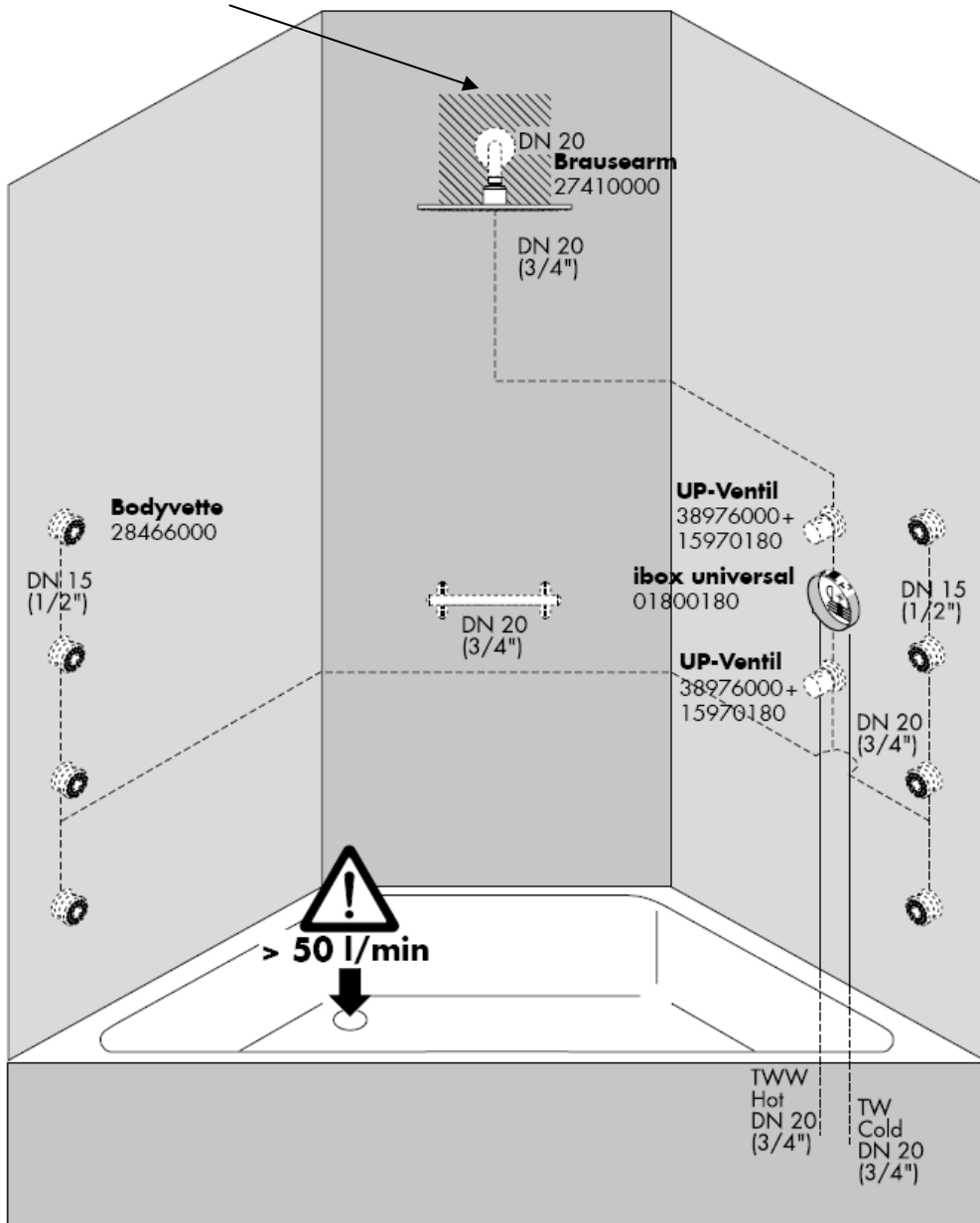

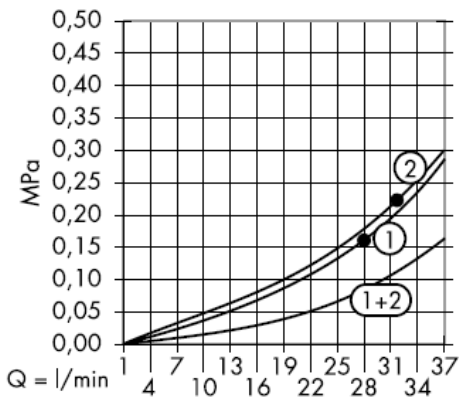

Гарантированное функционирование при показателях свыше •.

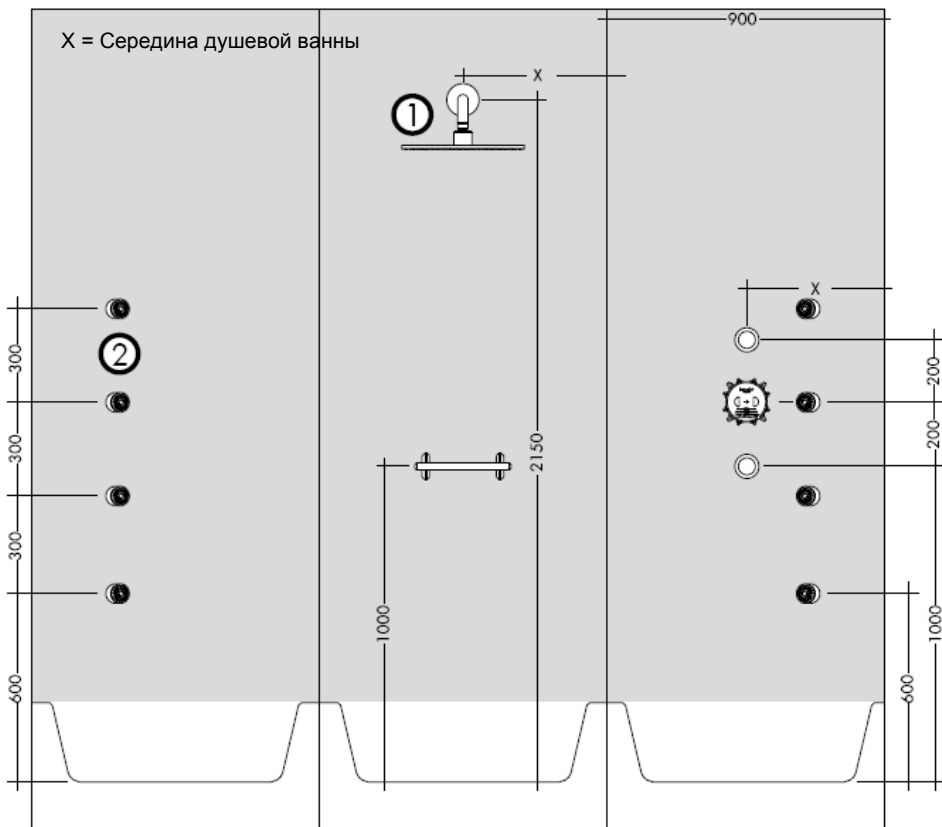

необходимо усиление стены для крепления душевой сетки

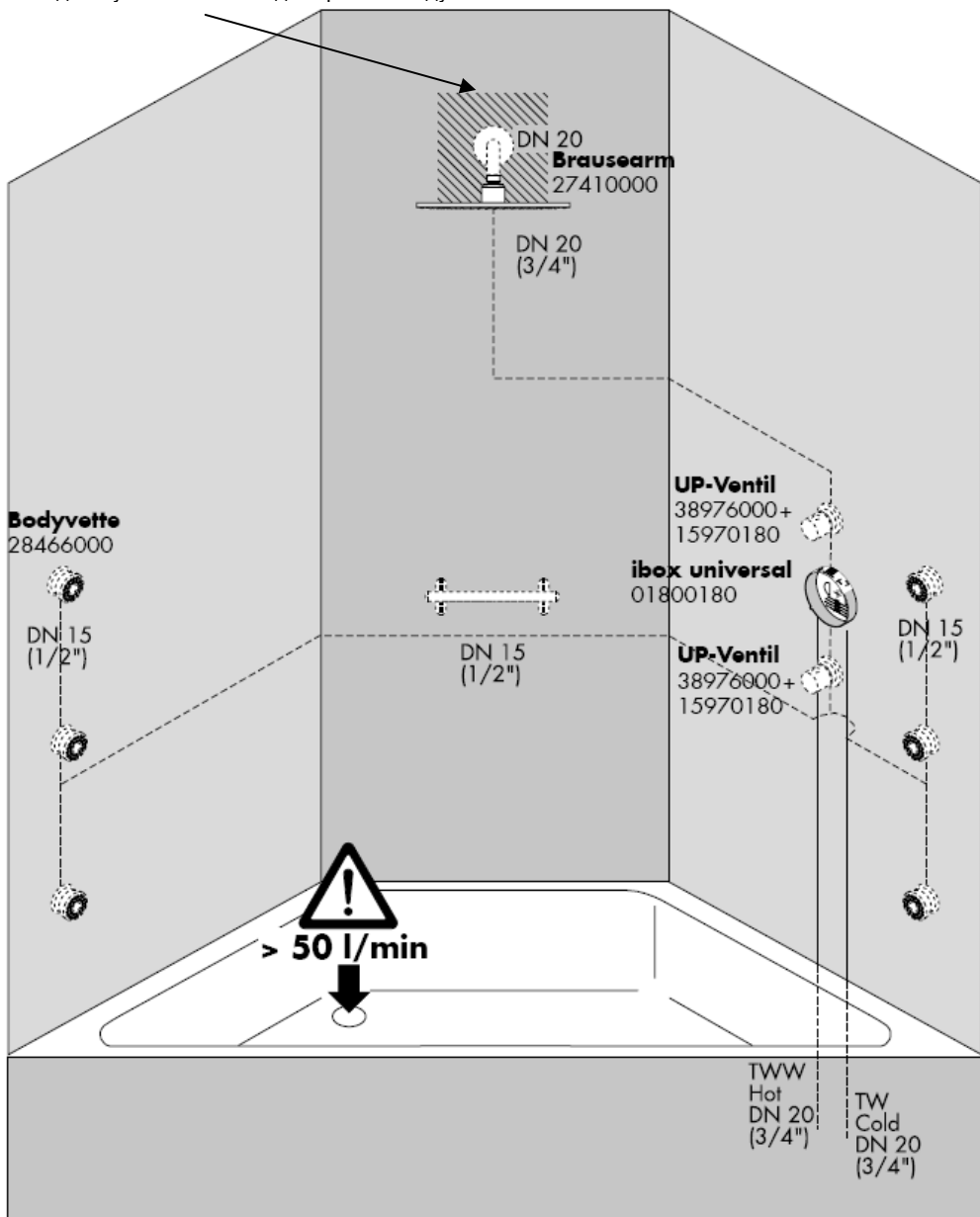

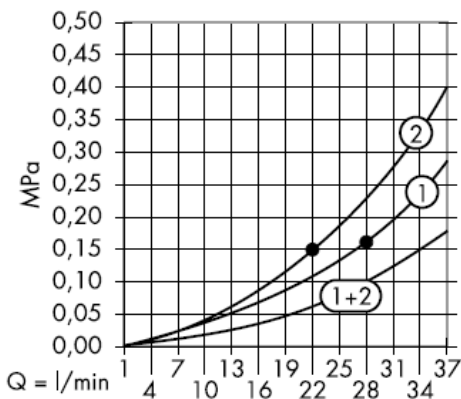

Гарантированное функционирование при показателях свыше *

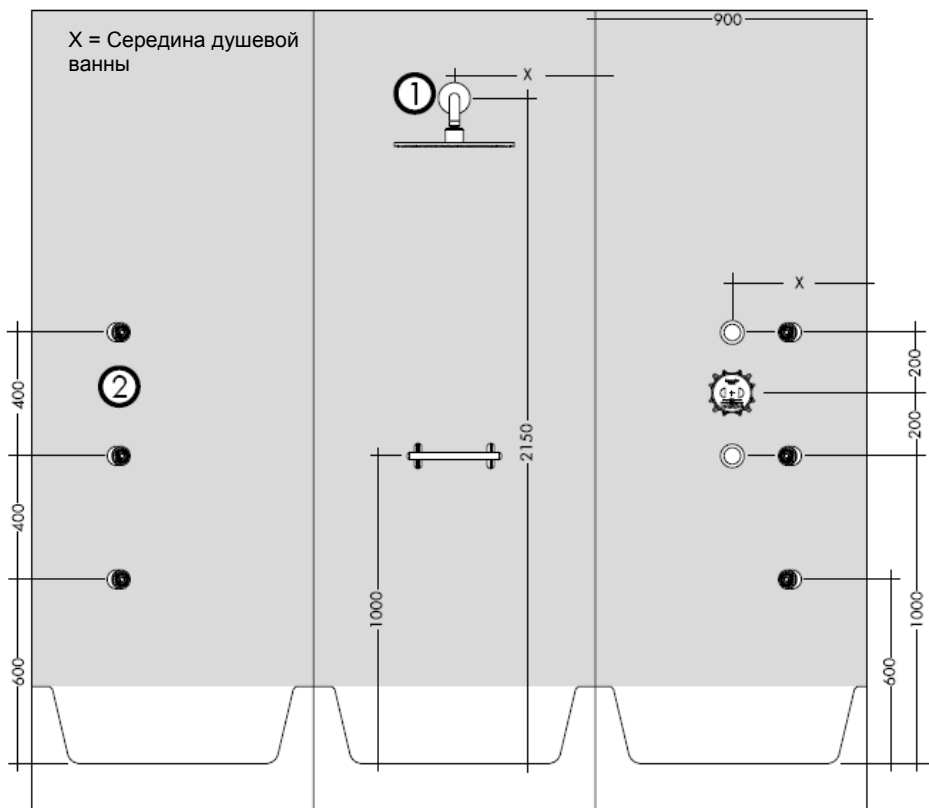

необходимо усиление стены для крепления душевой сетки

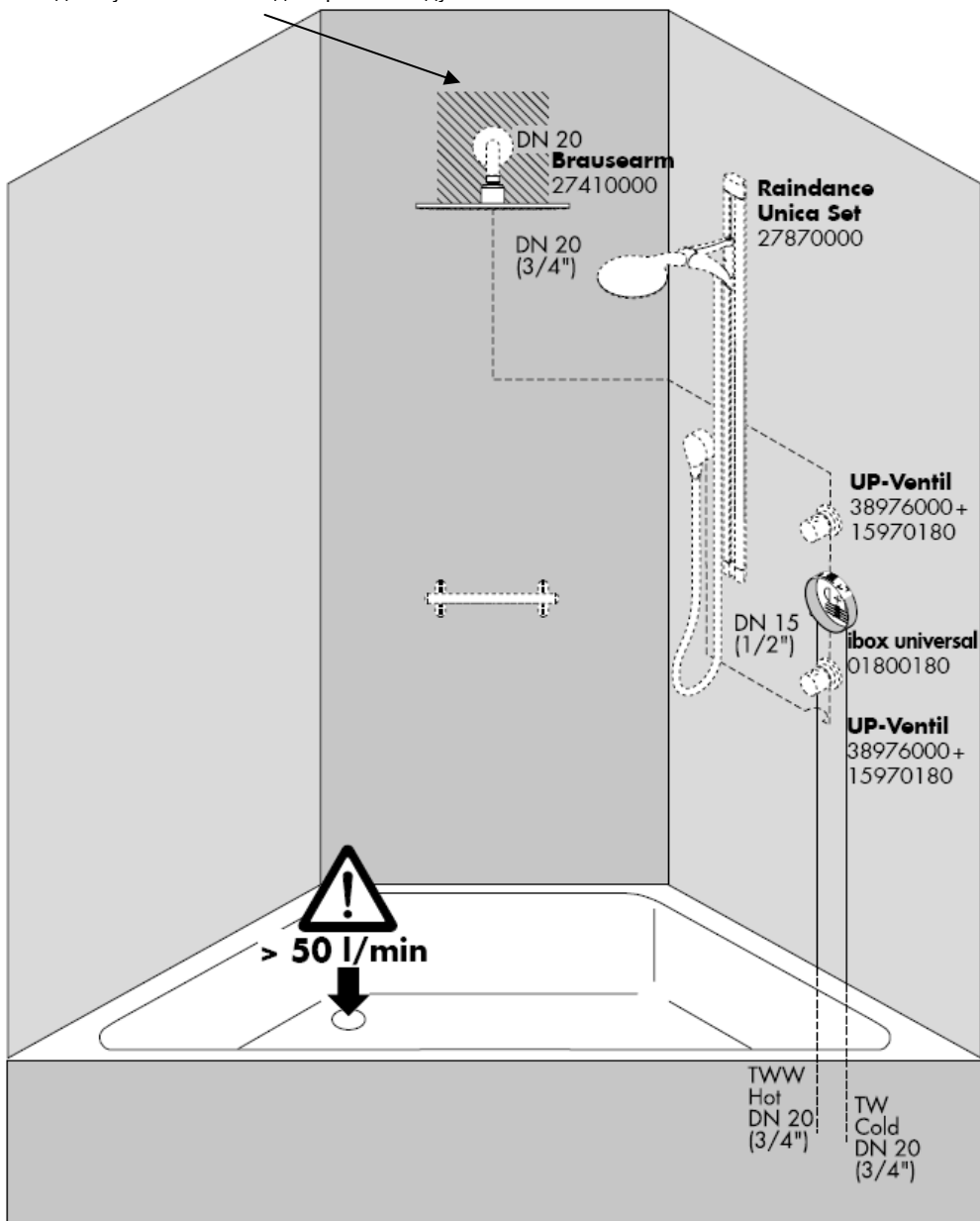

необходимо усиление стены для крепления душевой сетки

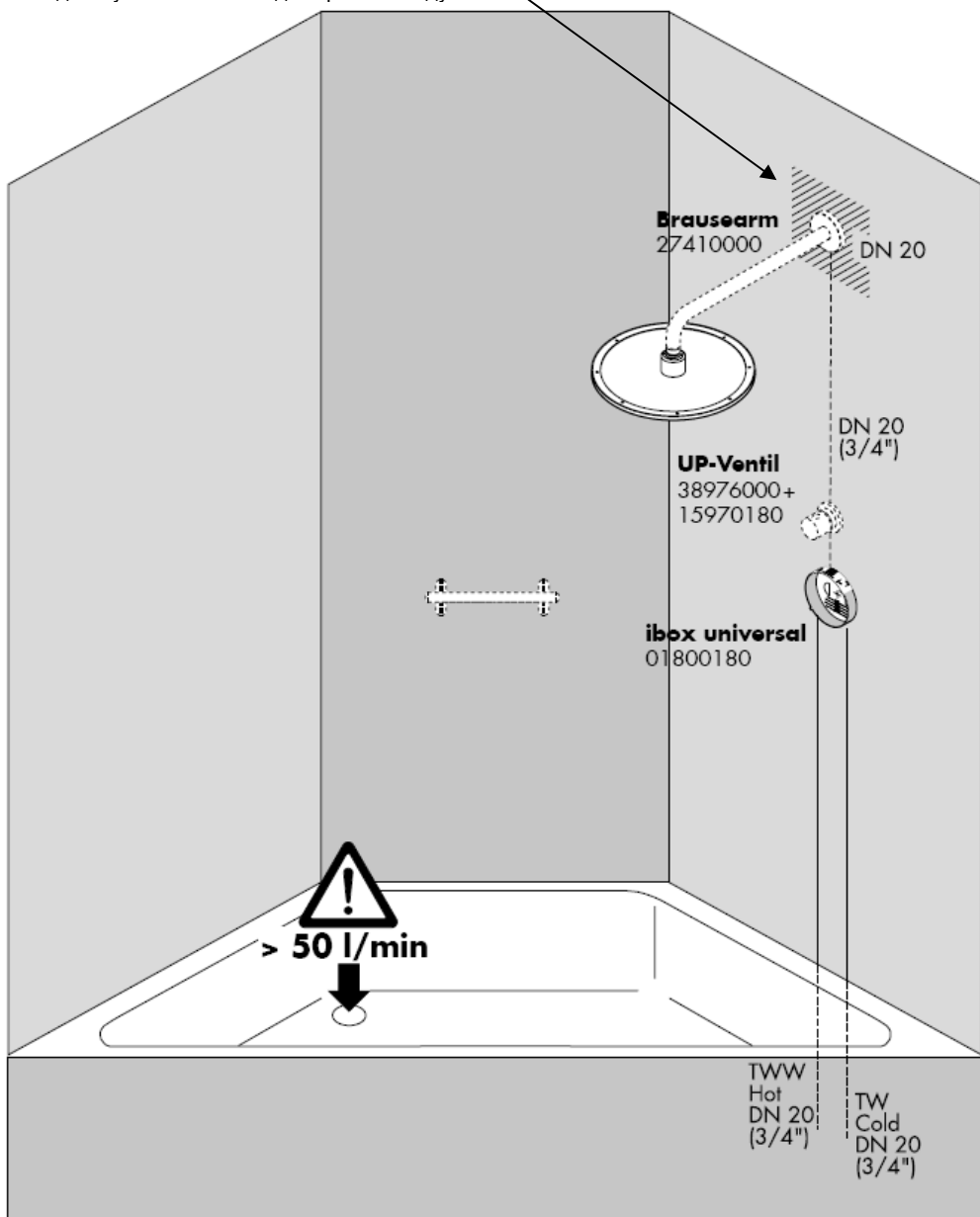

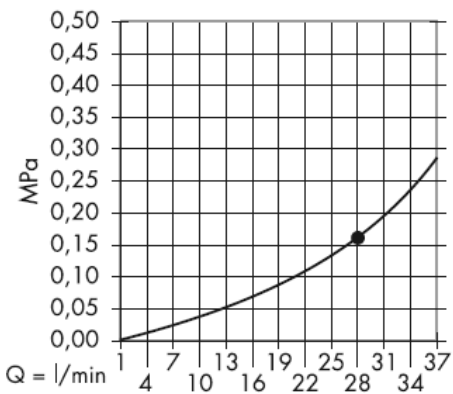

Гарантированное функционирование при показателях выше •.

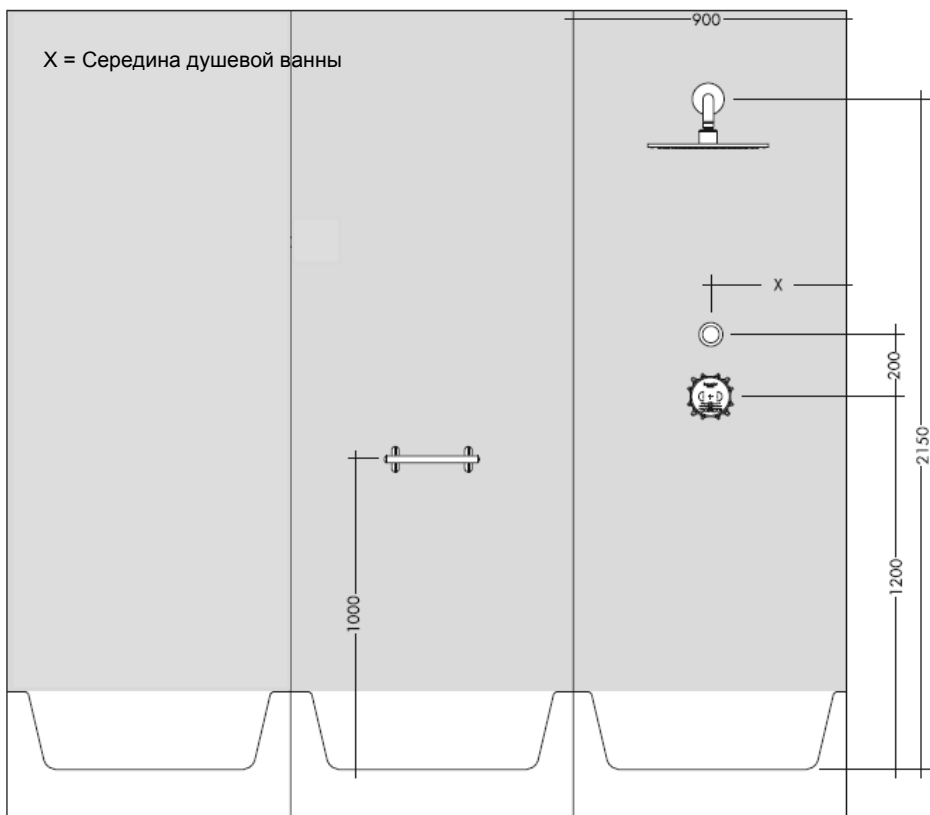

необходимо усиление стены для крепления душевой сетки

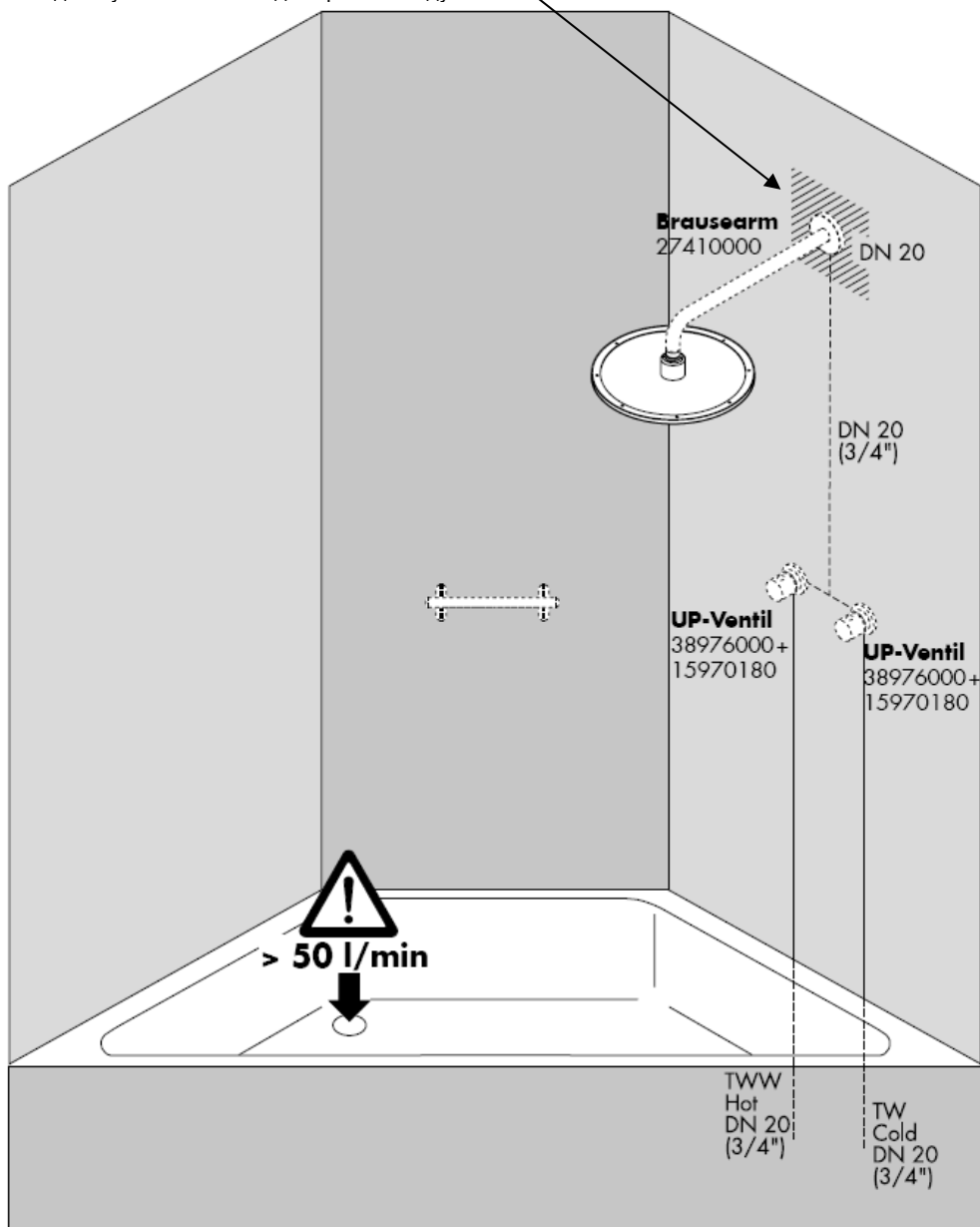

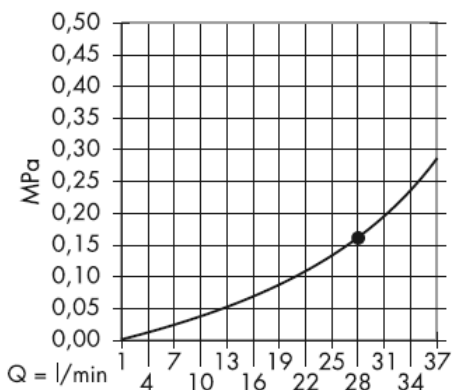

Гарантированное функционирование при показателях свыше *.

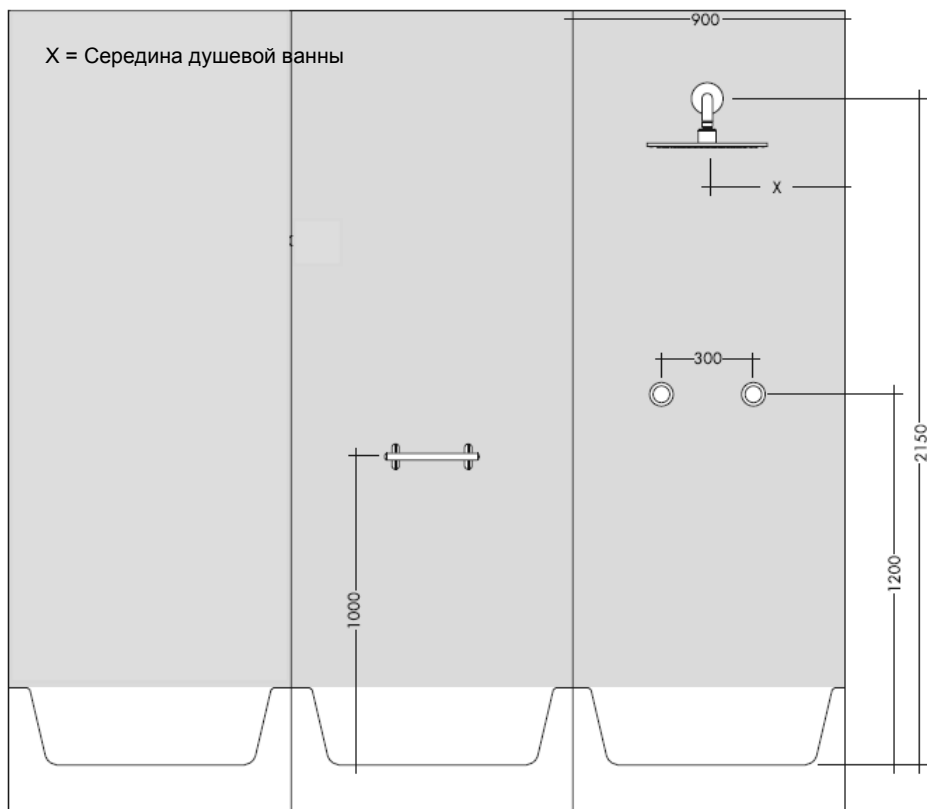

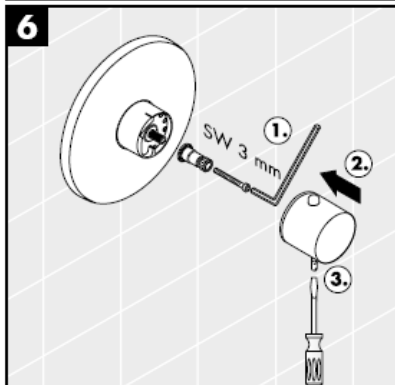
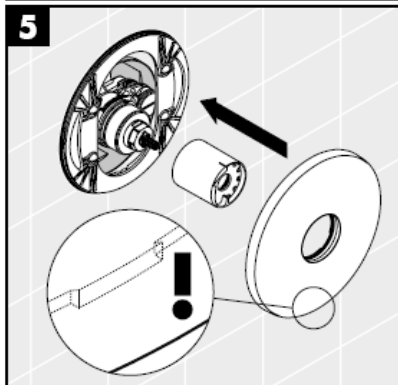
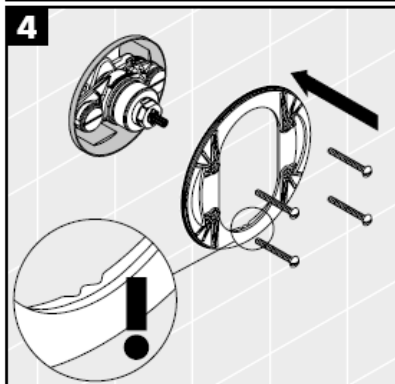
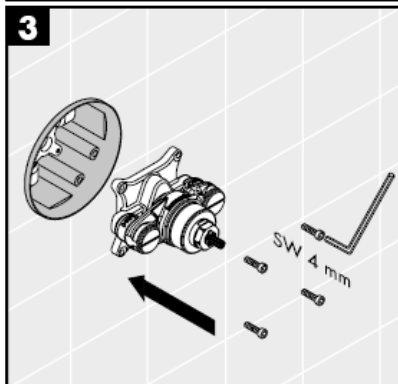
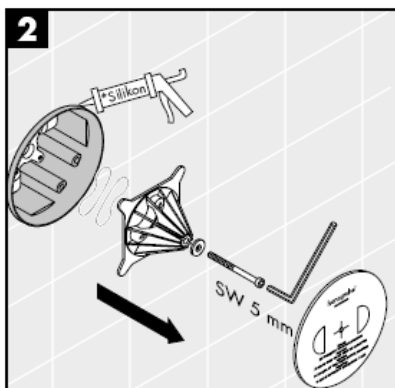
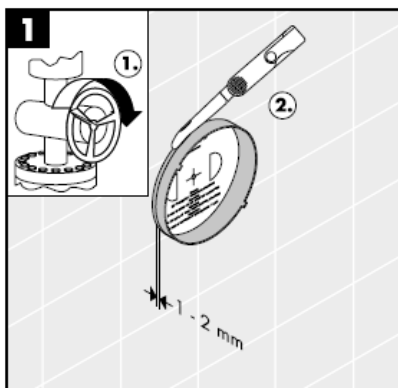

Силикон (не содержит уксусной кислоты!)

С помощью функции Safety Function может быть задана максимальная температура воды, например 42 C.

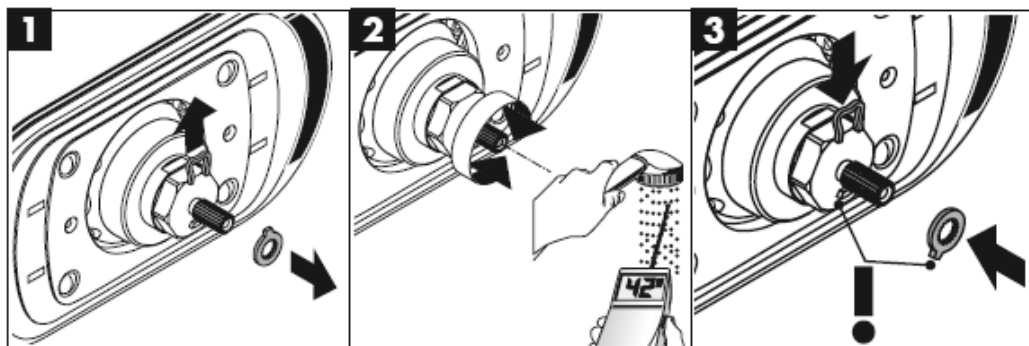

Настройка

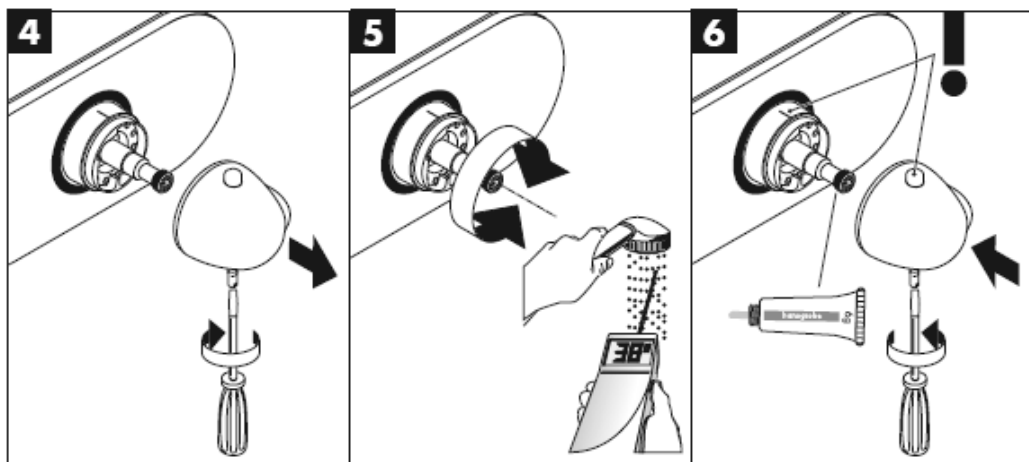



В рабочем состоянии вес душа со стойкой составляет приibl. 10 кг. По этой причине необходимо использовать подходящий крепеж для каменной стены! Входящие в комплект поставки болты и дюбеля подходят только для капитальной каменной стены.

Разрешается использовать только крепежный материал, предназначенный для кирпичной кладки! Прилагаемые винты и дюбели предназначены только для монолитных стен.

Слив должен иметь достаточную производительность.

Оптимальное функционирование гарантируется только при использовании в комбинации с термостатом High Flow Hansgrohe.

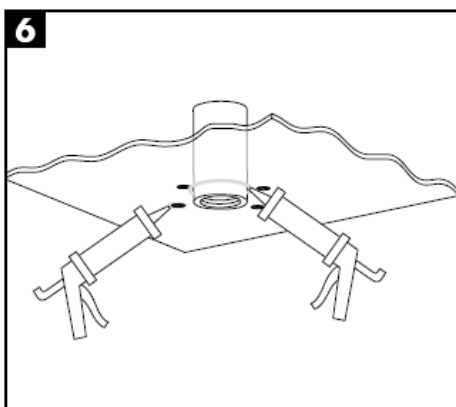
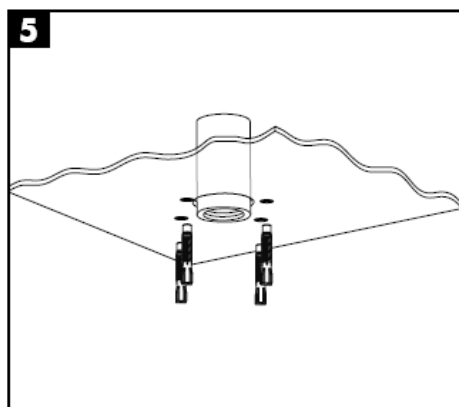
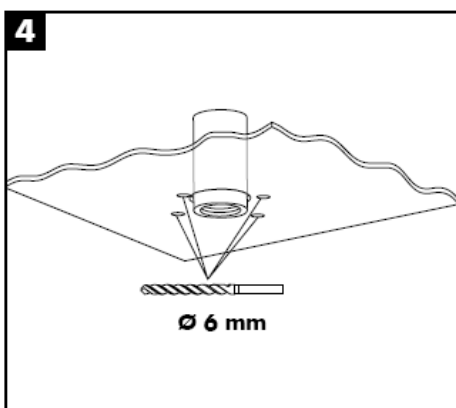
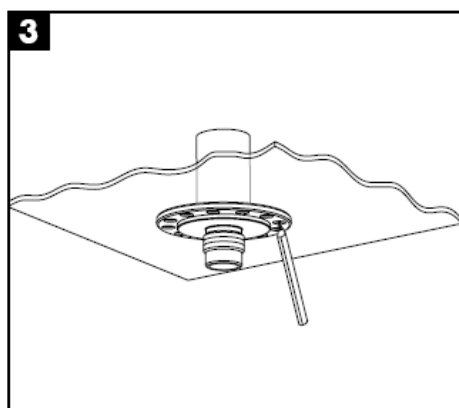
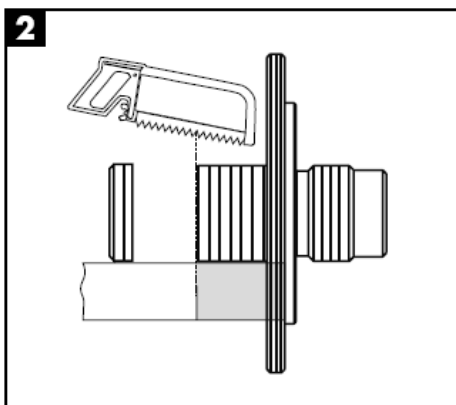
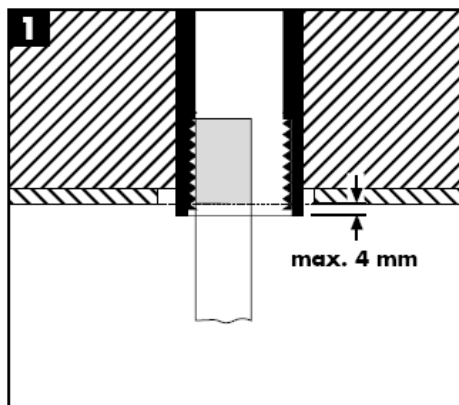

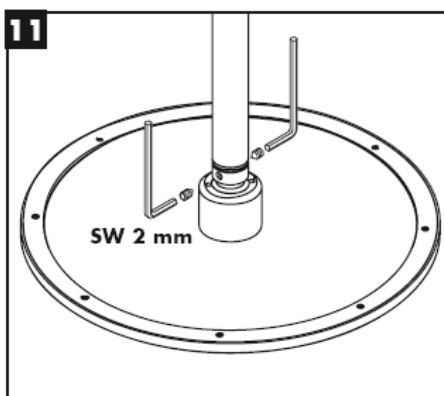
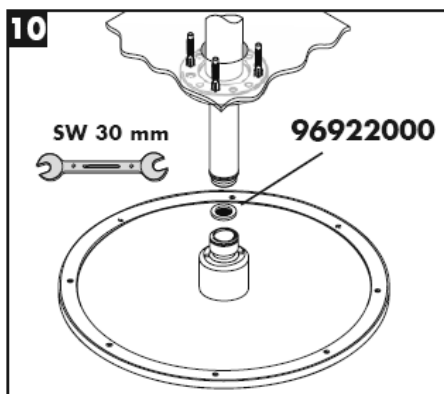
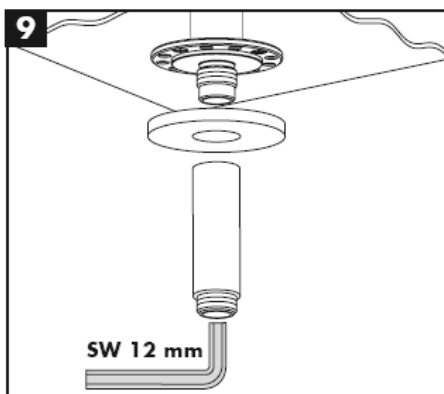
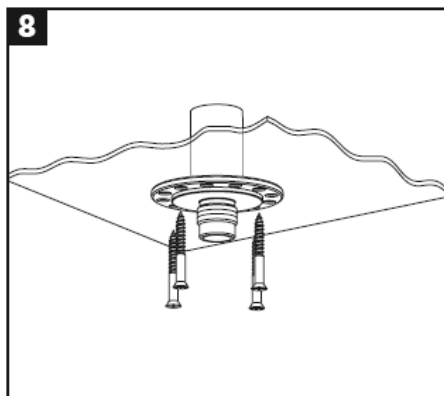
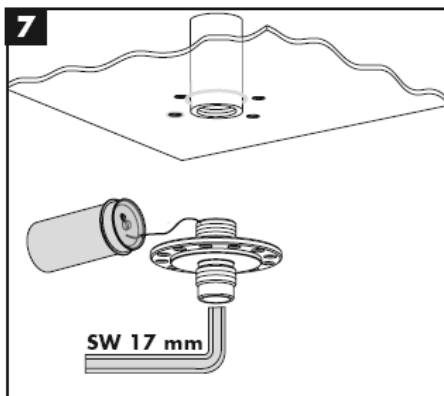

Для предотвращения попадания частиц грязи из водопроводной сети необходимо установить фильтр, прилагаемый к ручному душу. Частицы грязи могут нарушить отдельные функции и/или привести к повреждению функциональных деталей ручного душа. Hansgrohe не несет ответственность за повреждения вследствие отсутствия фильтра.

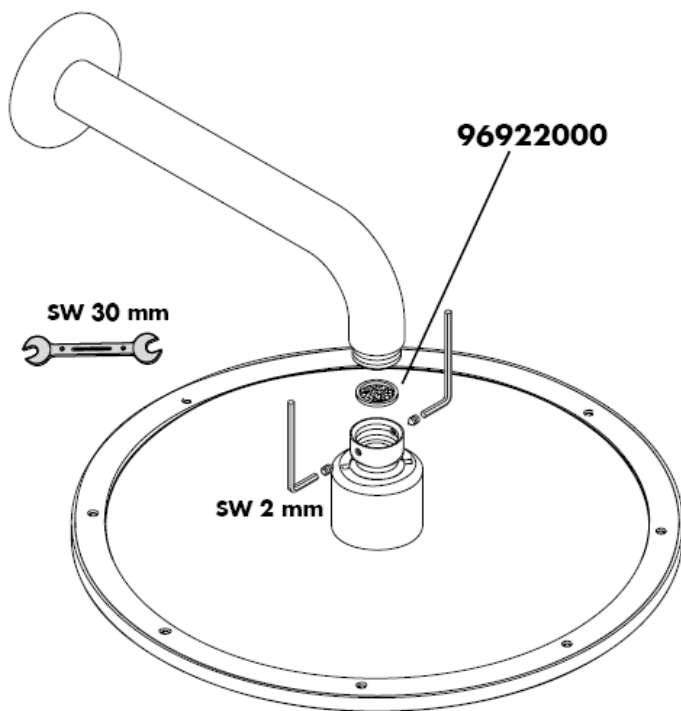

Монтаж

ВНИМАНИЕ! Смеситель должен быть смонтирован по действующим нормам и в соответствии с настоящей инструкцией, проверен на герметичность и безупречность работы

Настройка

Настройка работы необходима, если фактическая температура смешанной воды значительно отличается от показаний шкалы, нанесенной на изделие. Для настройки произведите следующие действия:

Поворотом рукоятки термостата добейтесь, чтобы температура воды из душа была 38 град.С.

Ослабив крепление рукоятки, переставьте ее в положение, указывающее на температуру 38 град. С и закрепите рукоятку в этом положении.

Ограничение температуры

Температура смешанной воды ограничена 38 град.С (100 град.Ф). Если необходимо получить более горячую воду, нужно, нажав на красную кнопку продолжать вращение рукоятки до достижения необходимой температуры.

Safety Function

С помощью функции Safety Function может быть задана максимальная температура воды, например 42 С. см. стр. 21.

Технические данные

Рабочее давление: max. 1 МПа
 Рекомендуемое рабочее давление: 0,1 – 0,5 МПа
 Давлении: 1,6 МПа
 (1 МПа = 10 bar = 147 PSI)
 Температура горячей воды: max.80° С
 Рекомендуемая темп. гор. воды: 65° С
 Пропускная способность: ca.58 л/мин 0,3 МПа

Техническое обслуживание

Термостат не требует специального обслуживания. Защита обратного тока должна регулярно проверяться (минимум один раз в год) по стандарту DIN EN 1717 или в соответствии с национальными или региональными нормативами Состояние фильтра (6.1), установленного на термостатическим картридже. После замены термoeлементa необходимо проверить работу смесителя и, проверив условия водоснабжения, произвести настройку (см. выше), изменяя положение стопорного кольца. Для гарантии плавного изменения температуры и долгого срока службы необходимо периодически поворачивать ручку регулировки температуры из положение максимально горячая в положение максимально холодная вода.

Для гарантии плавного изменения температуры и долгого срока службы необходимо периодически поворачивать ручку регулировки температуры из положение максимально горячая в положение максимально холодная вода.

Комплект см. стр. 3

1	ручка термостата	38391000
2	Розетка	96452000
3	гильза	97439000
4	Винты кронштейна	96454000
5	несущие розетки	96447000
6	регулятор температуры	96633000
7	Улавливающий фильтр	97367000
8	Защита обратного тока воды	96655000
9	Удлинение 25 мм	13595000
10	Удлинение 25 мм	13596000

Русский

Неисправность	Причина	Устранение неисправности
недостаточный давление (если устан напор воды)	-Проблемы водоснабжения -Фильтр термoeлементa загрязнен -Фильтр душа загрязнен	-Проверить овлен насос проверить работу насоса -Очистить фильтр -Очистить фильтр
Подмес воды, в закрытом положении горячая вода стремится в подводку холодной воды или наоборот	-Клапан обратного тока воды загрязнен или неисправен	-Замените клапаны обратного течения
Температура смешанной воды не соответствует шкале	-Термостат не настроен -Температура горячей воды слишком низкая	-Настроить термостат -Поднять температуру горячей воды с 42 град.С до 65 град.С
Регулировка температура не производится	-Термoeлемент загрязнен или покрыт известью -повернуть внутренний блок	-для вновь установленного изделия: ошибка установки, холод ная вода подводится справа горячая слева, или установлено с 180 град поворотом. -Красная кнопка защиты от ожога не работает
Износ пружины кнопки	-Очистите пружину или кнопку и слегка смажьте, при необходимости замените -Заизвесткованность кнопки	-Очистите пружину или кнопку и слегка смажьте, при необходимости замените -Очистите пружину или кнопку и слегка смажьте, при необходимости замените

Знак технического контроля

	P-IX	DVGW	SVGW	WRSA	KIWA	ACS	NF
27070000						X	
27418XXX							
28420000						X	
28435XXX						X	

Очистка

Простота чистки: известь очень легко стирается с утолщений.

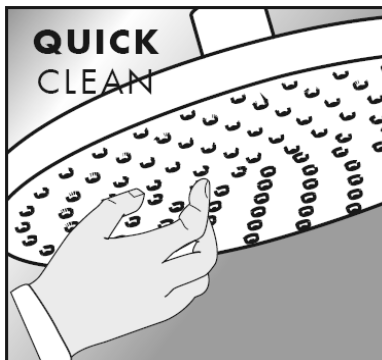

Руководство по уходу за изделием

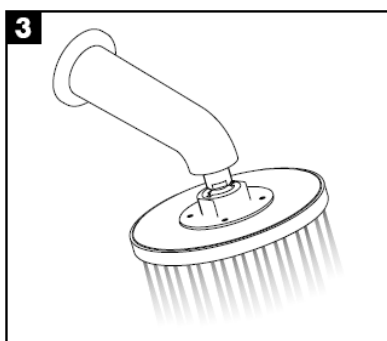
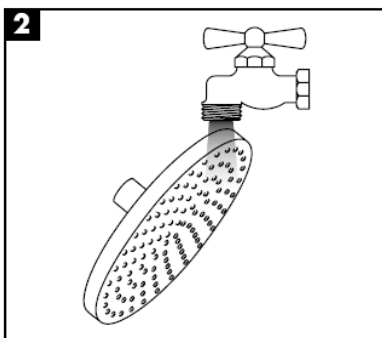
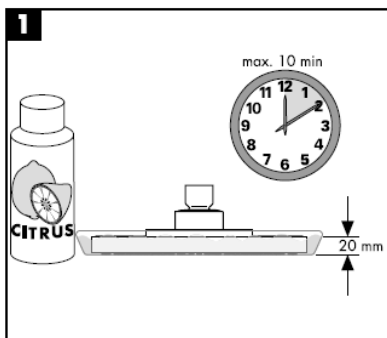

hansgrohe

Szerelési útmutató



27418XXX

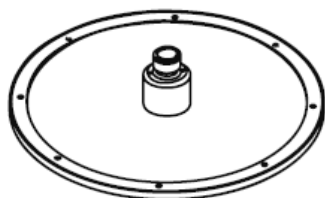

Raindance Royale AIR
28420000

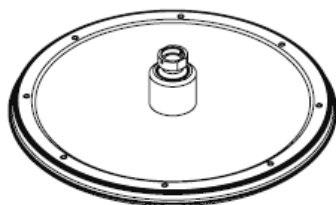

Raindance Royale Classic AIR
28435XXX

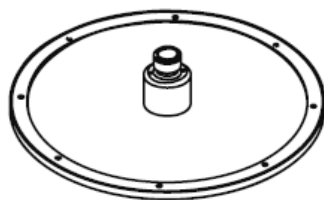

**Raindance Royale
High Flow Set**
27070000

hansgrohe

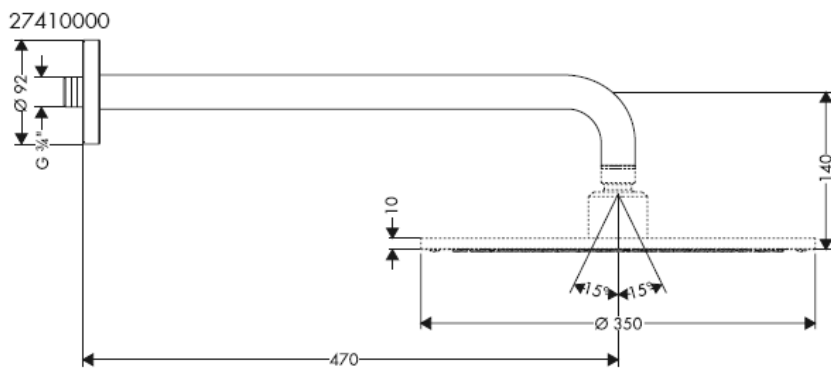
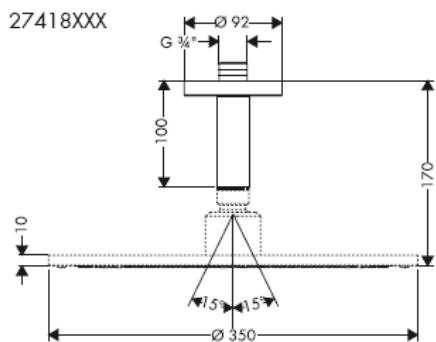
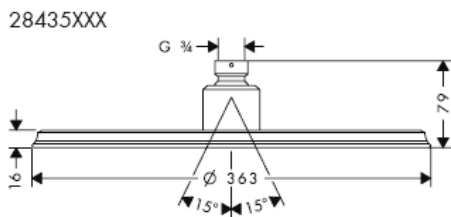
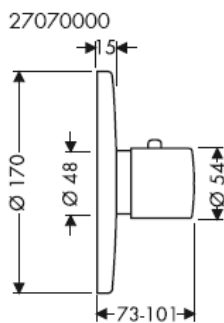
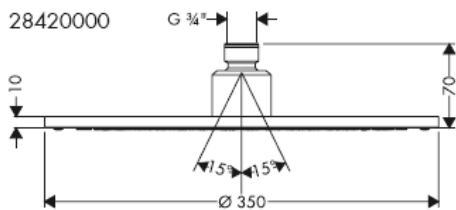

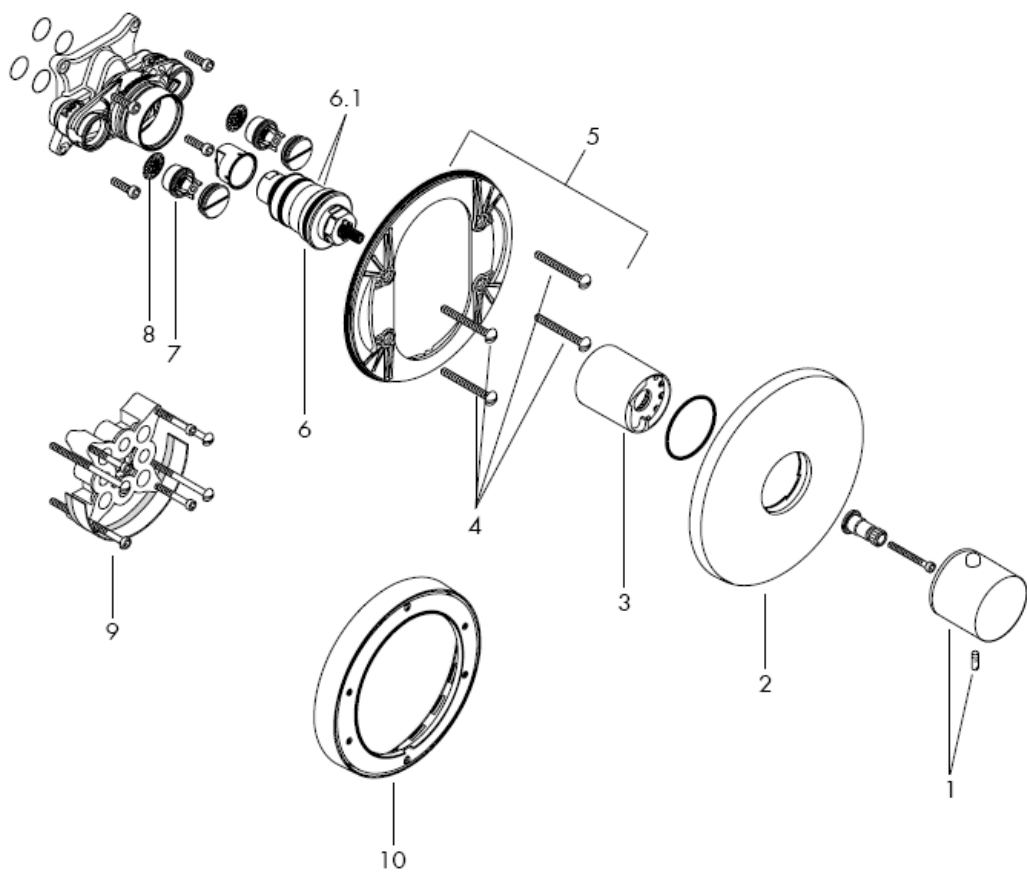

A méretet a lehetőségekhez mérten igazítsuk a csempe elrendezéséhez.

Vnější sprchy je nutné zesílení zdi

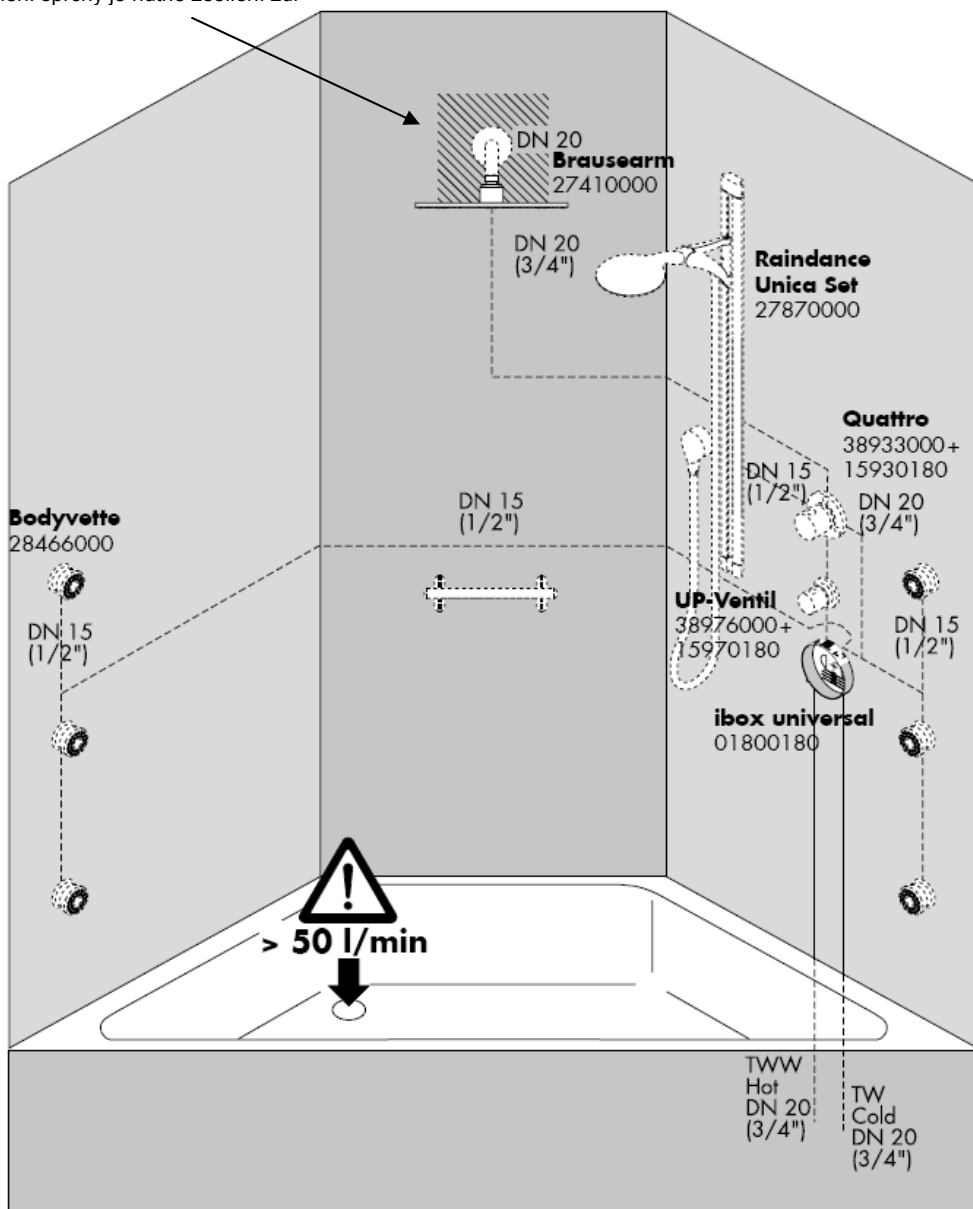

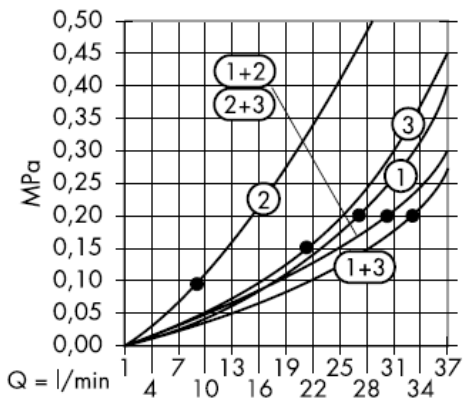

A • -től működik az adott funkció.

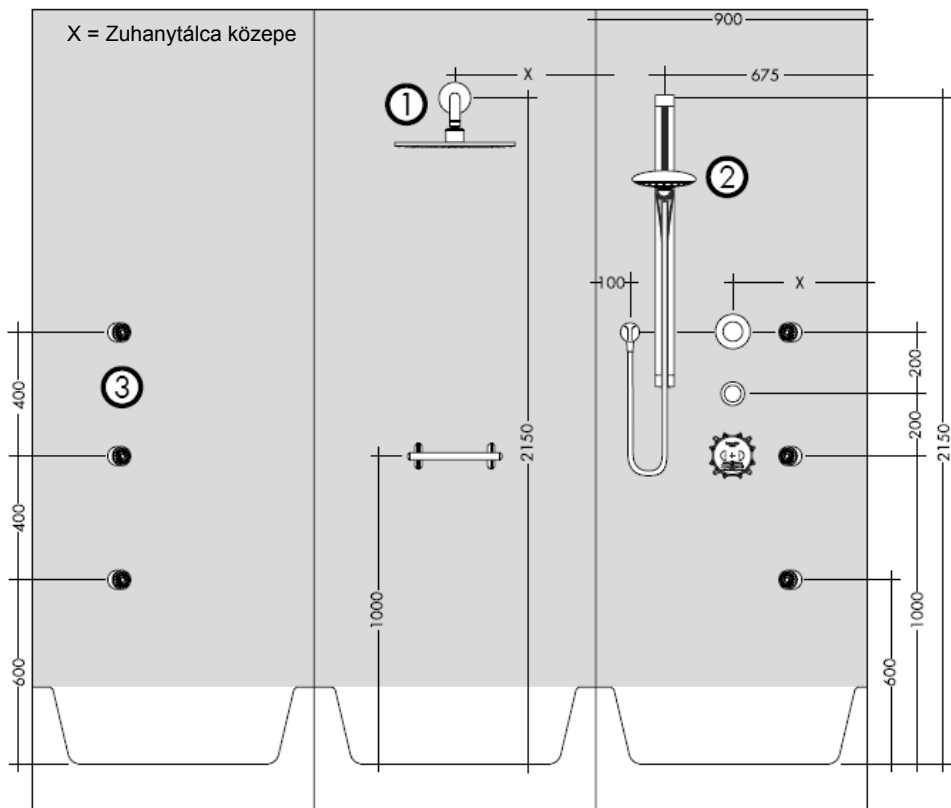

Vnější sprchy je nutné zesílení zdi

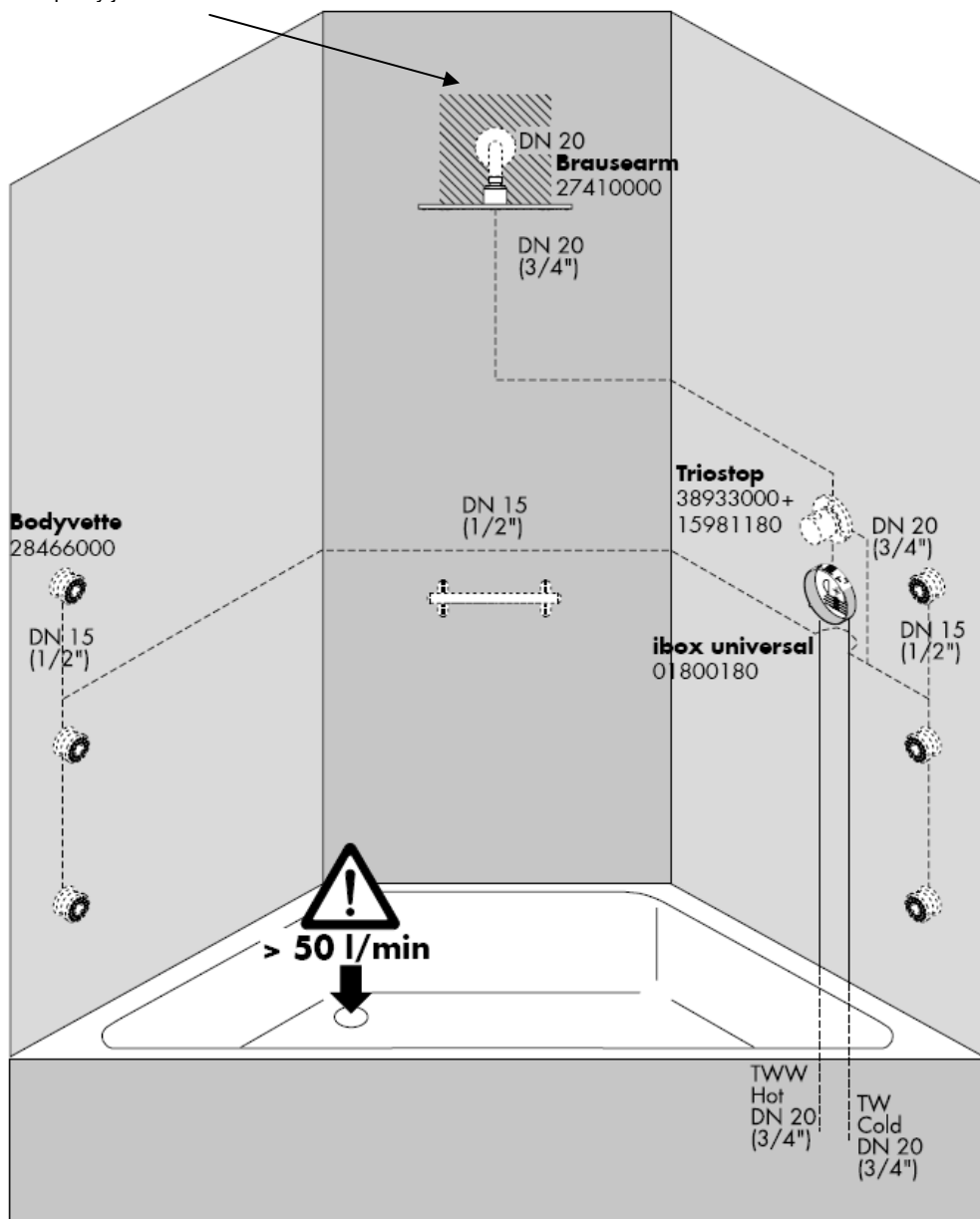

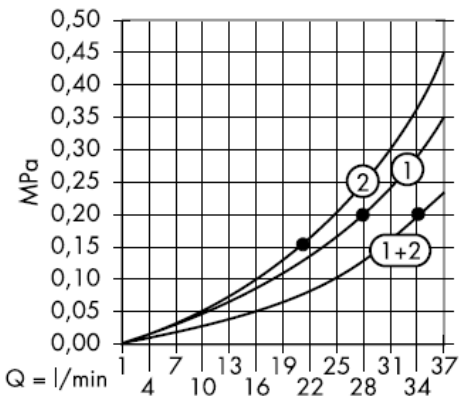

A • -től működik az adott funkció.

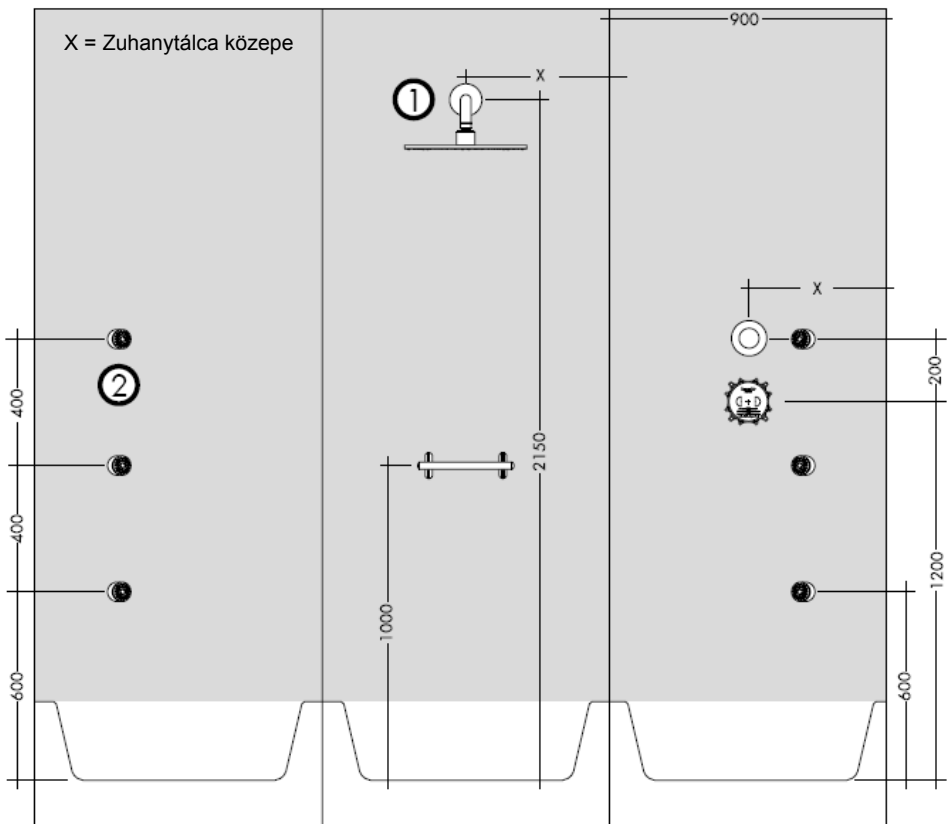

Vnější sprchy je nutné zesílení zdi

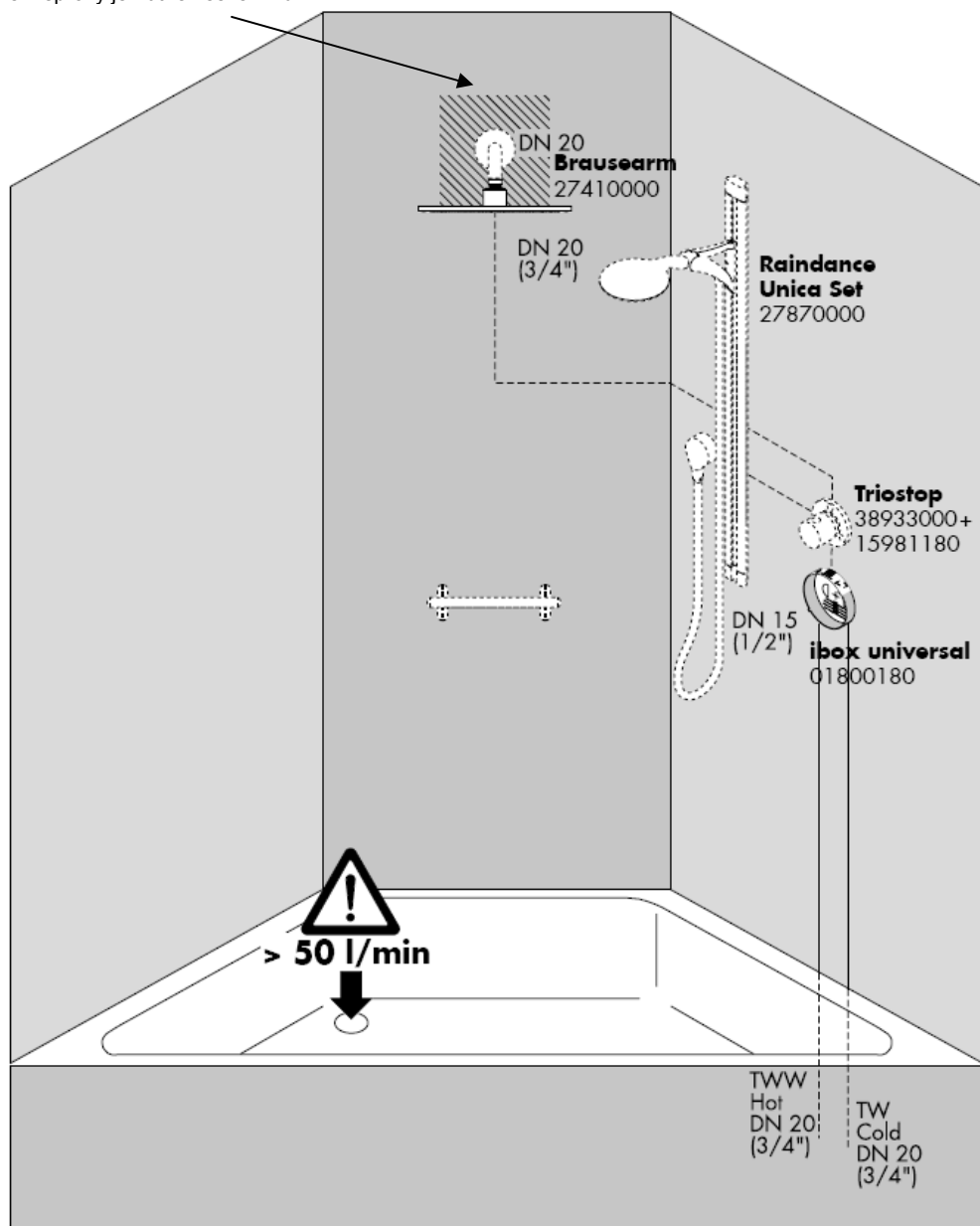

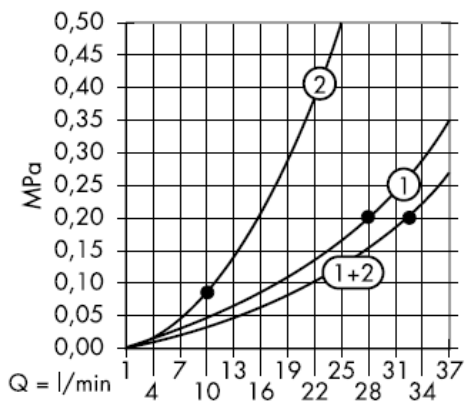

A • -től működik az adott funkció.

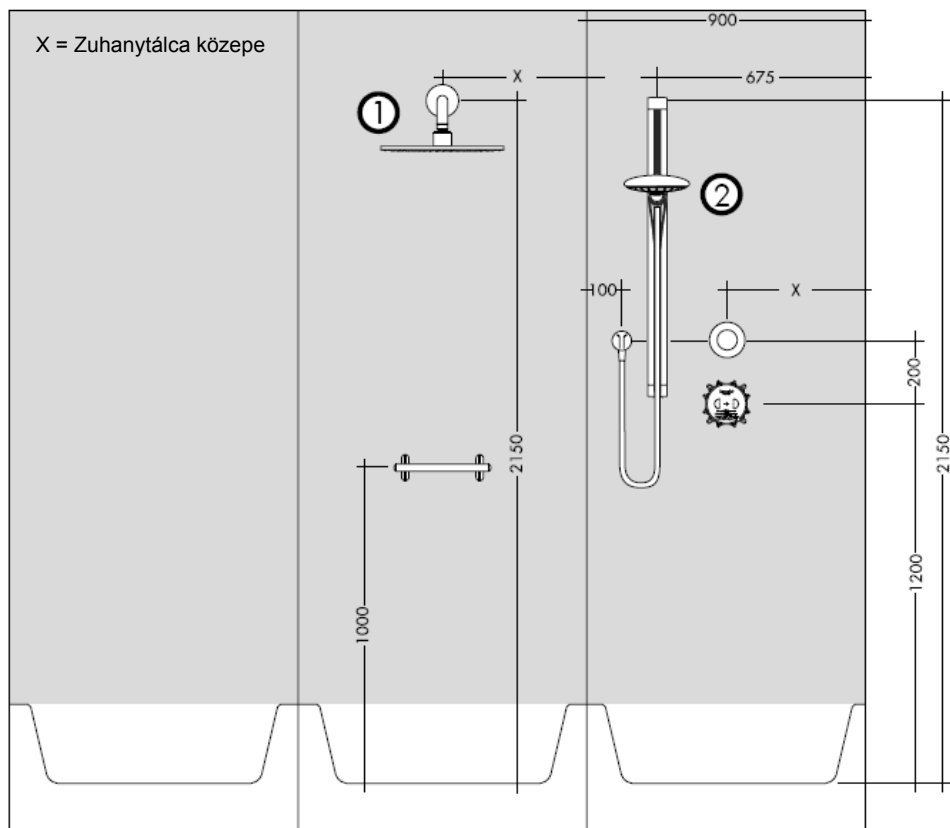

Vnější sprchy je nutné zesílení zdi

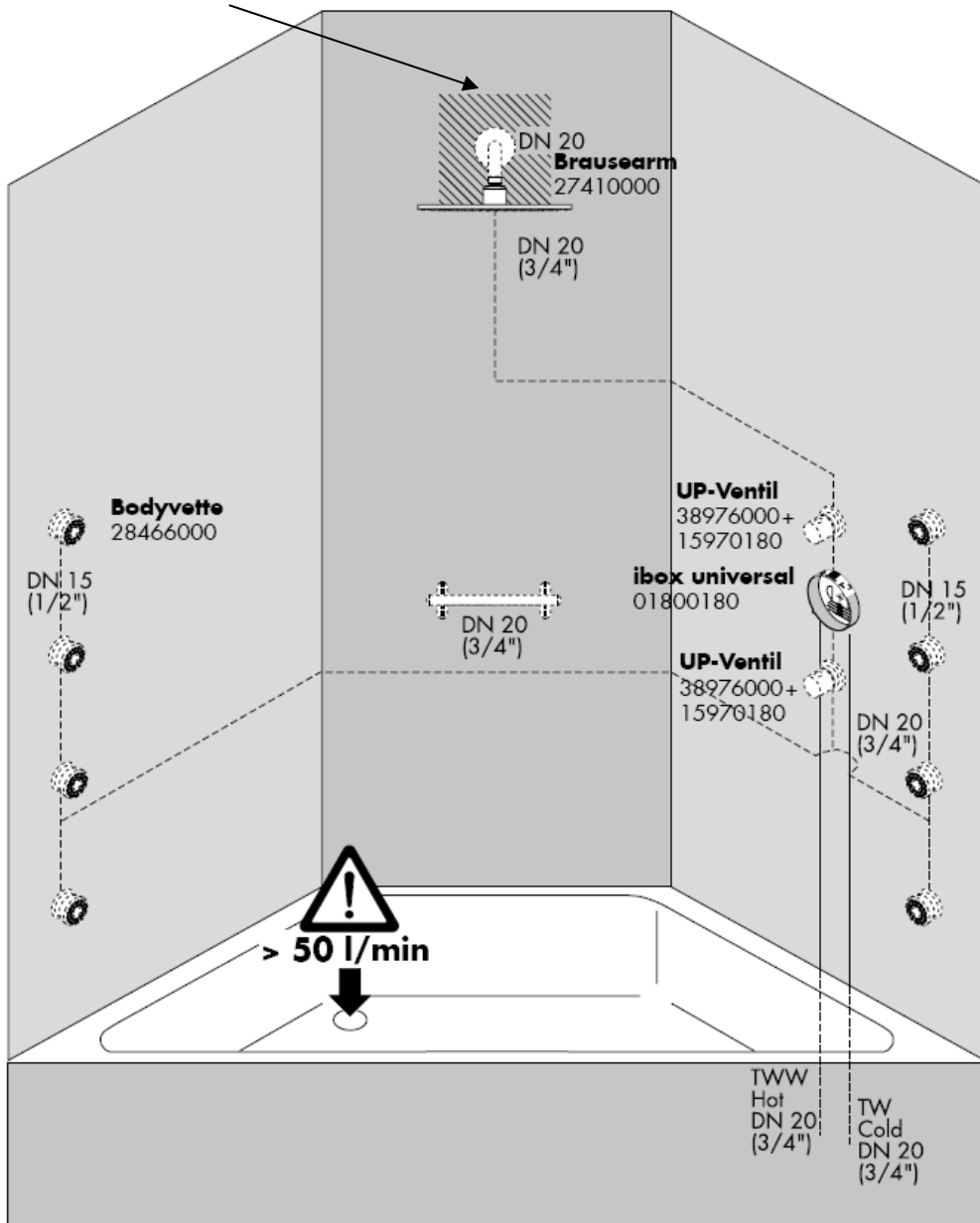

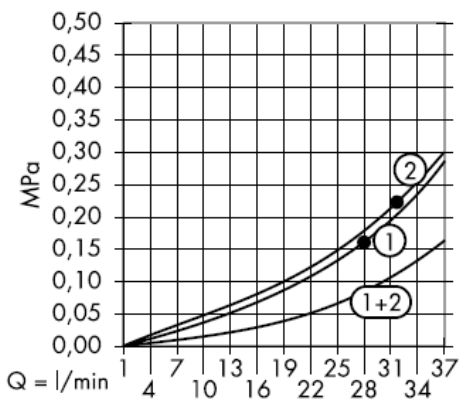

A • -től működik az adott funkció.

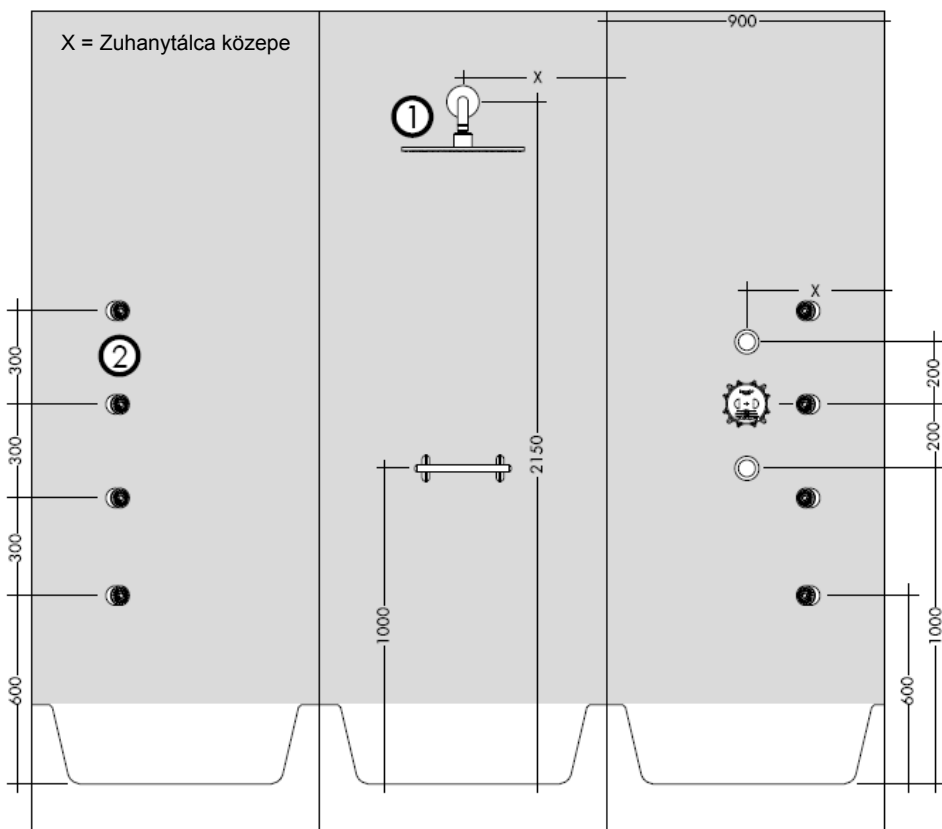

Vnější sprchy je nutné zesílení zdi

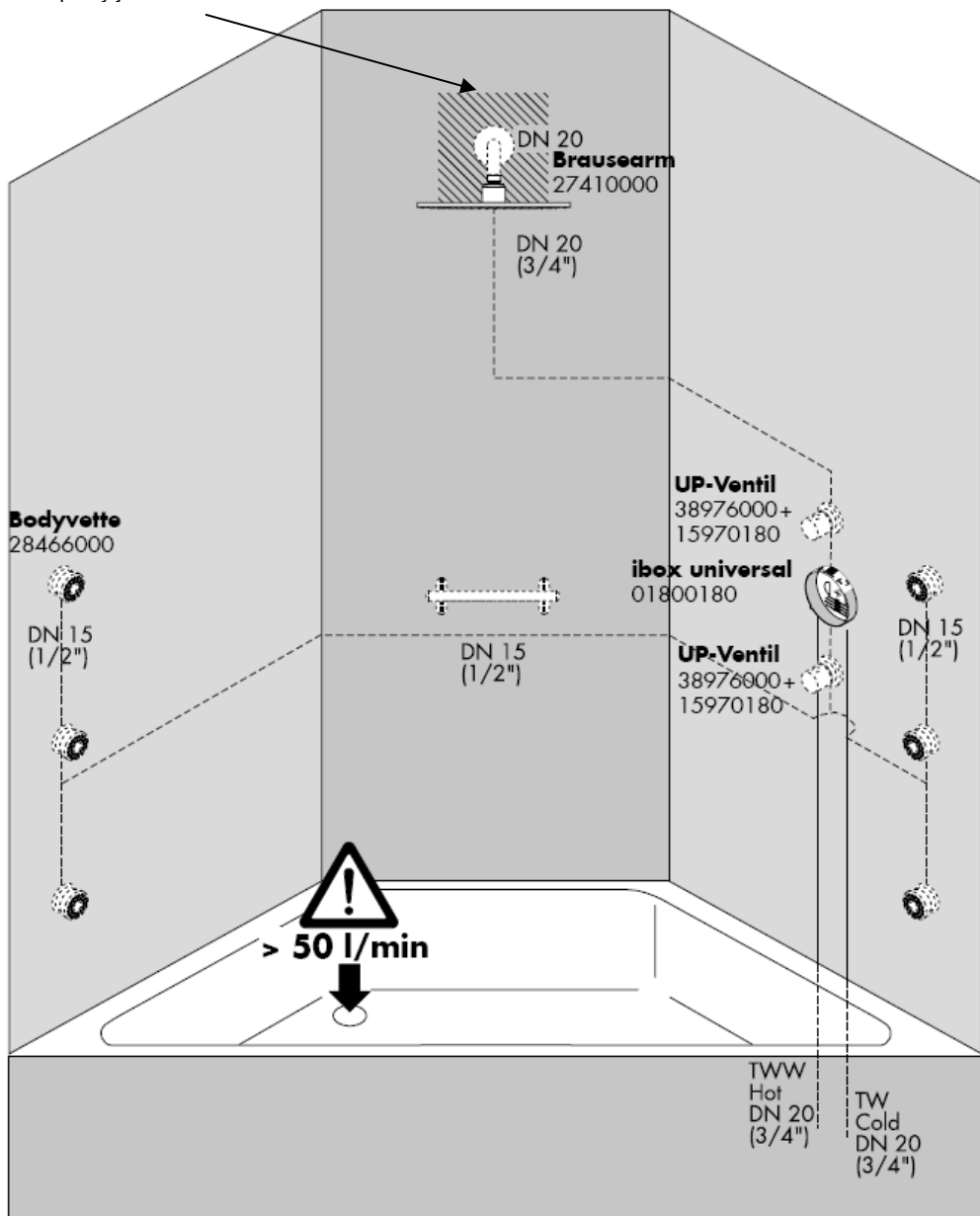

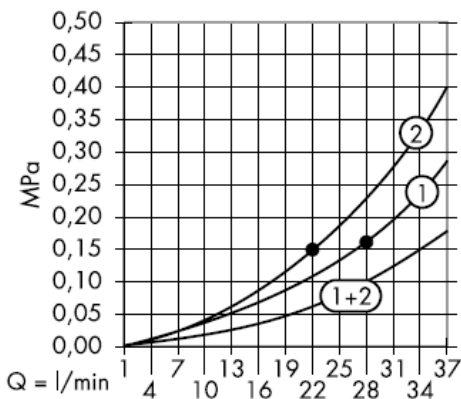

A • -től működik az adott funkció.

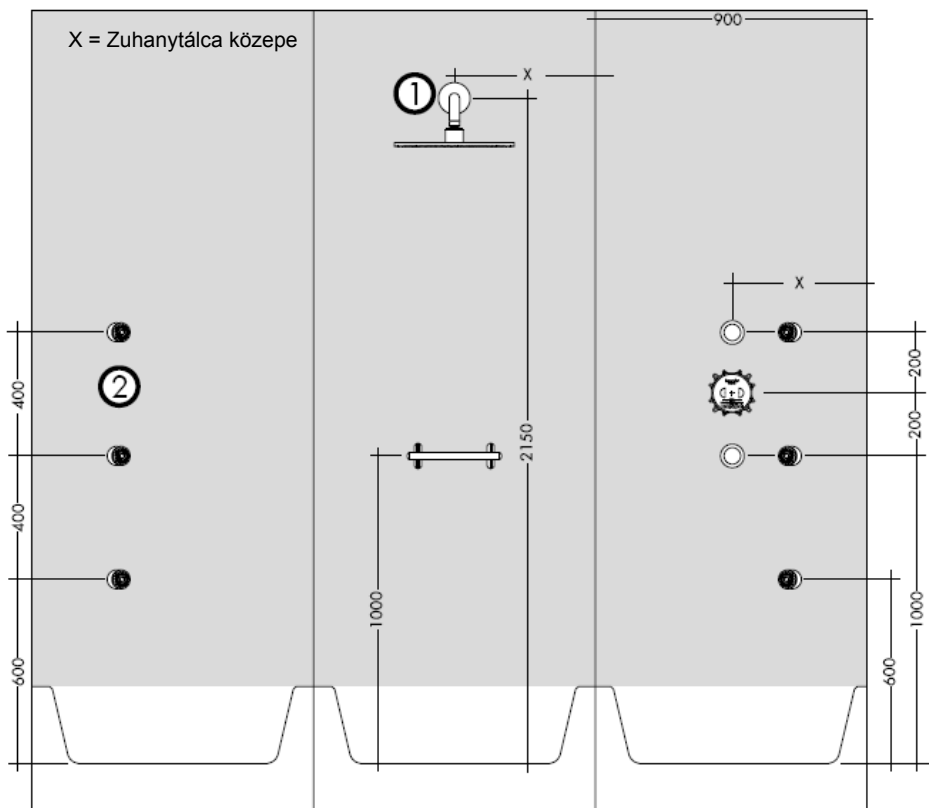

Vnější sprchy je nutné zesílení zdi

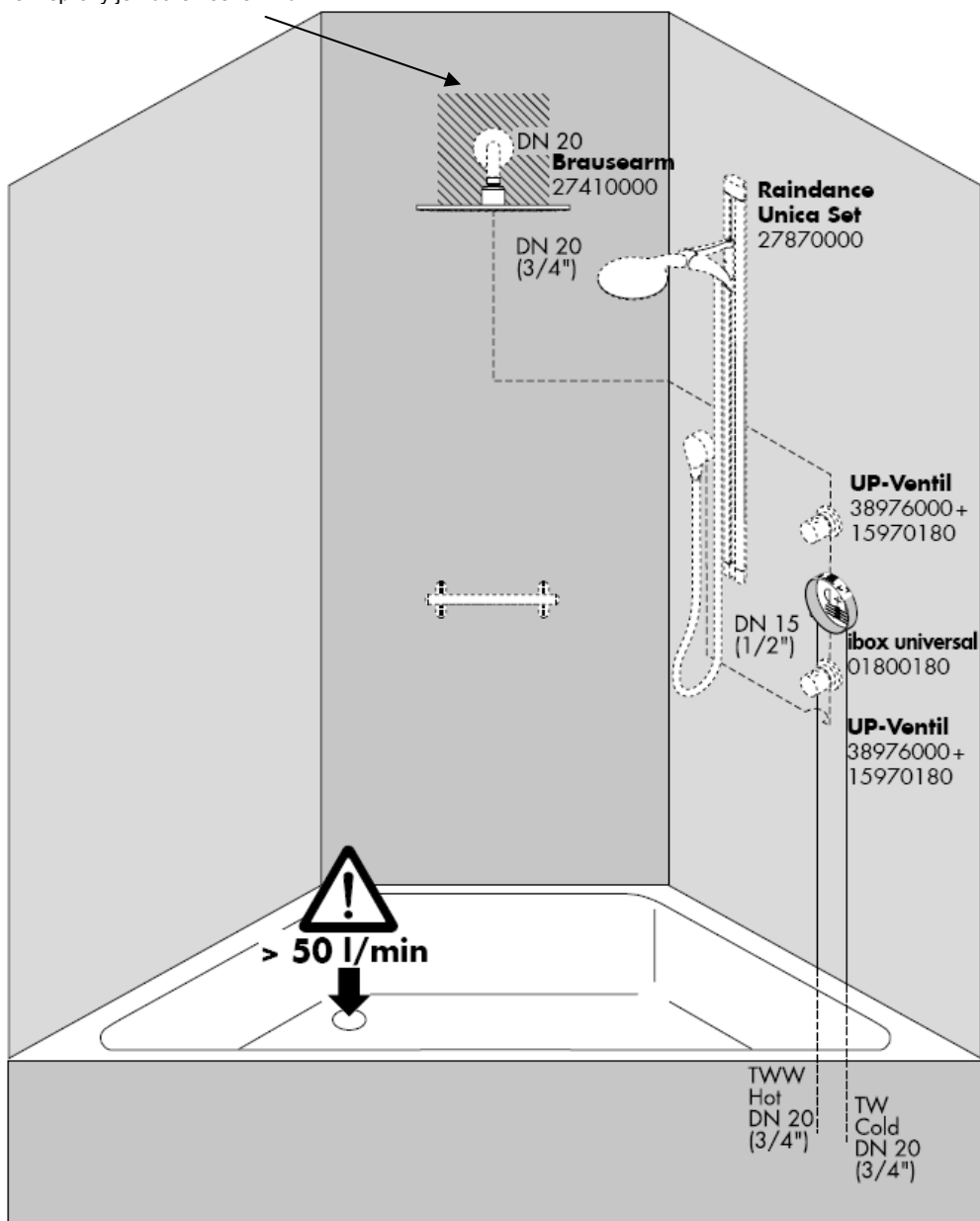

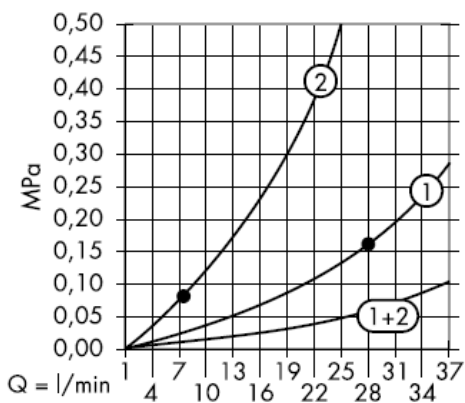

A • -től működik az adott funkció.

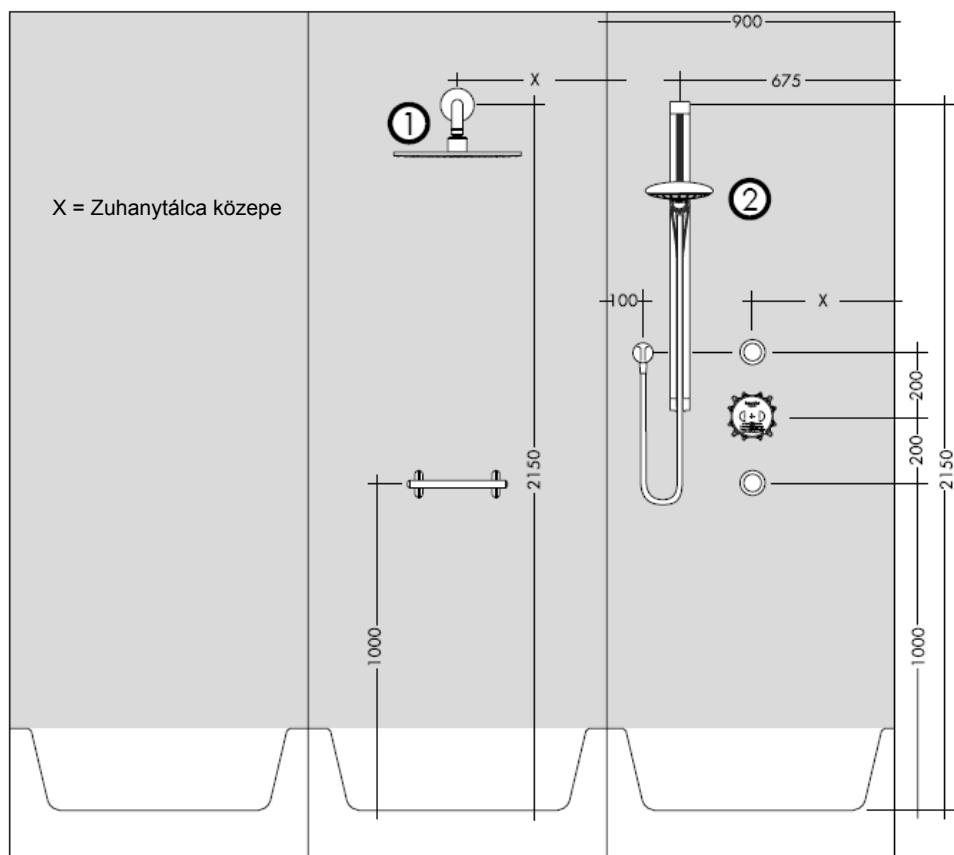

Vnější sprchy je nutné zesílení zdi

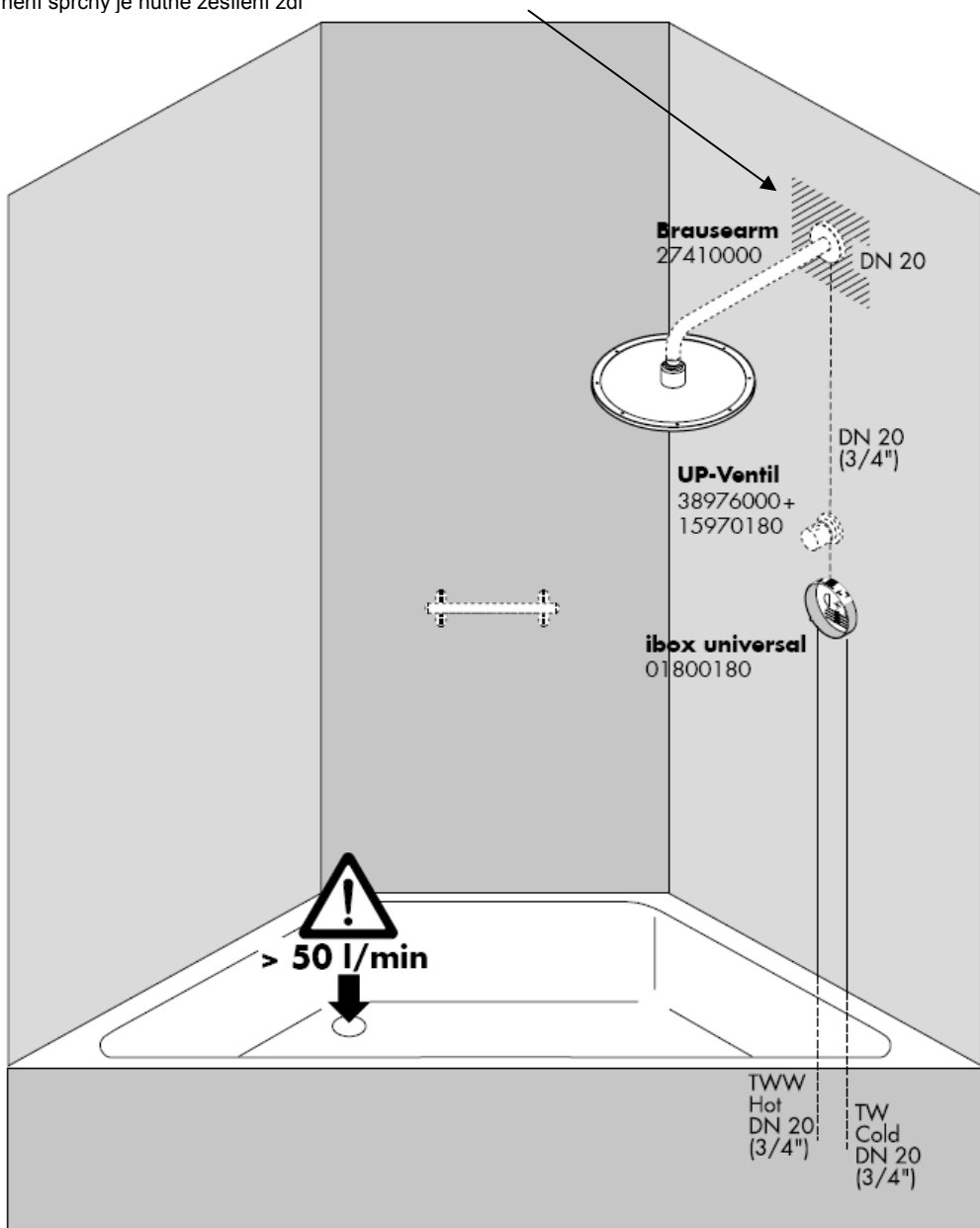

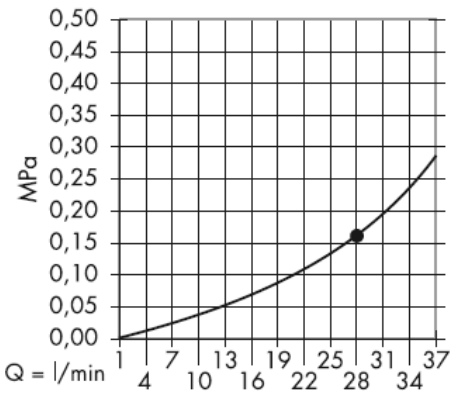

A • -től működik az adott funkció.

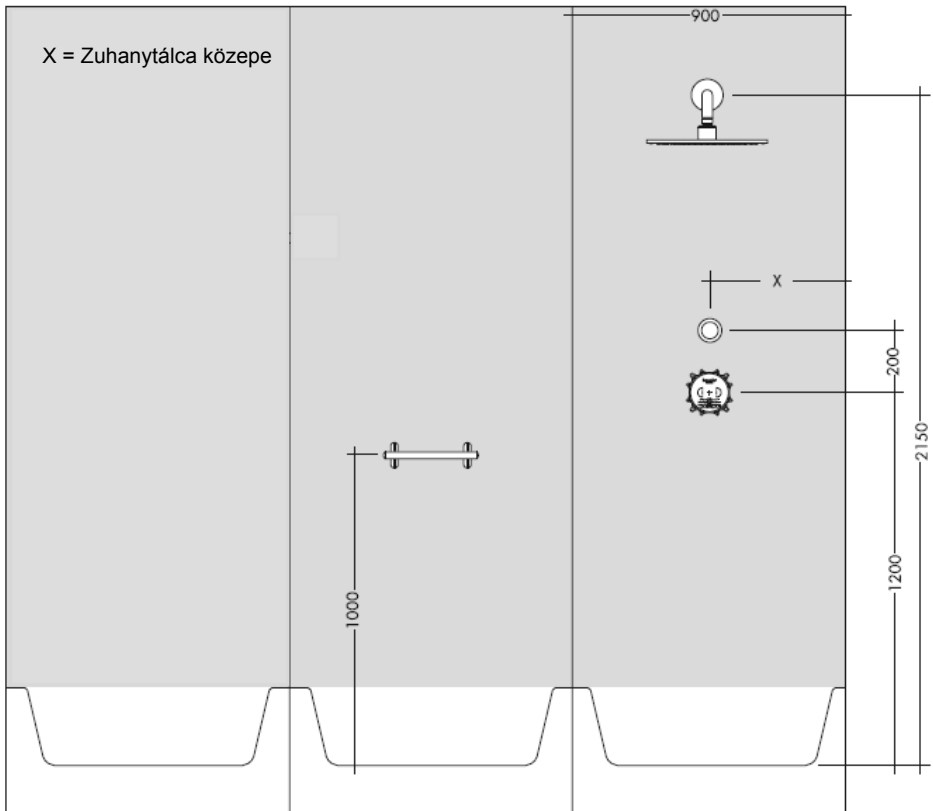

Vnější sprchy je nutné zesílení zdi

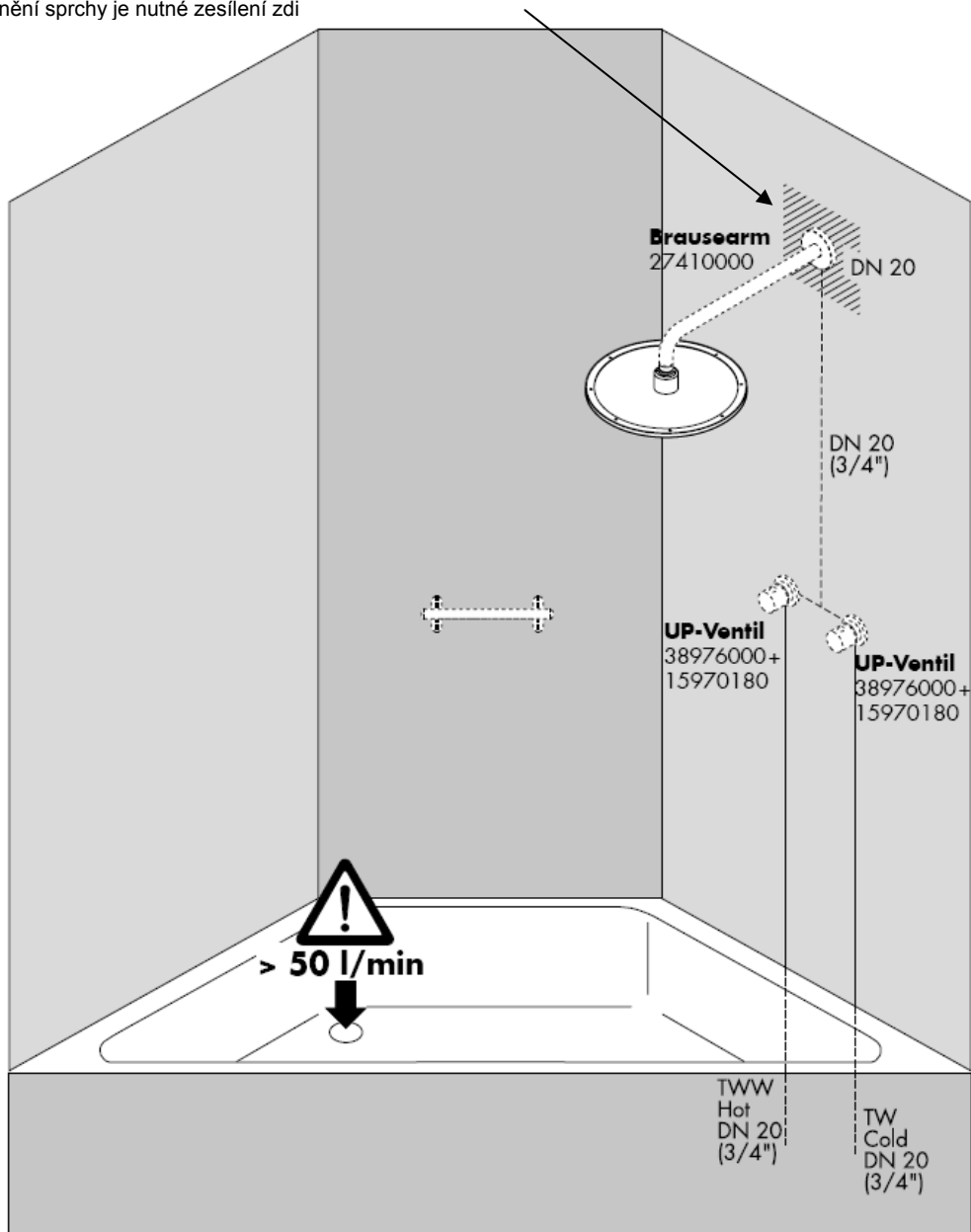

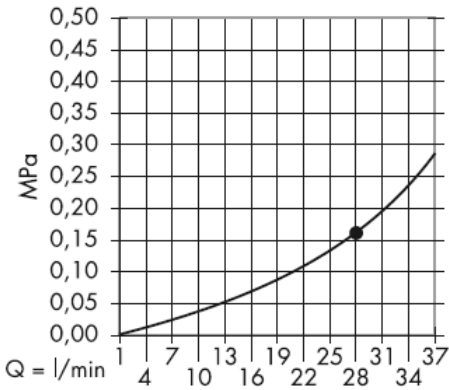

A • -től működik az adott funkció.

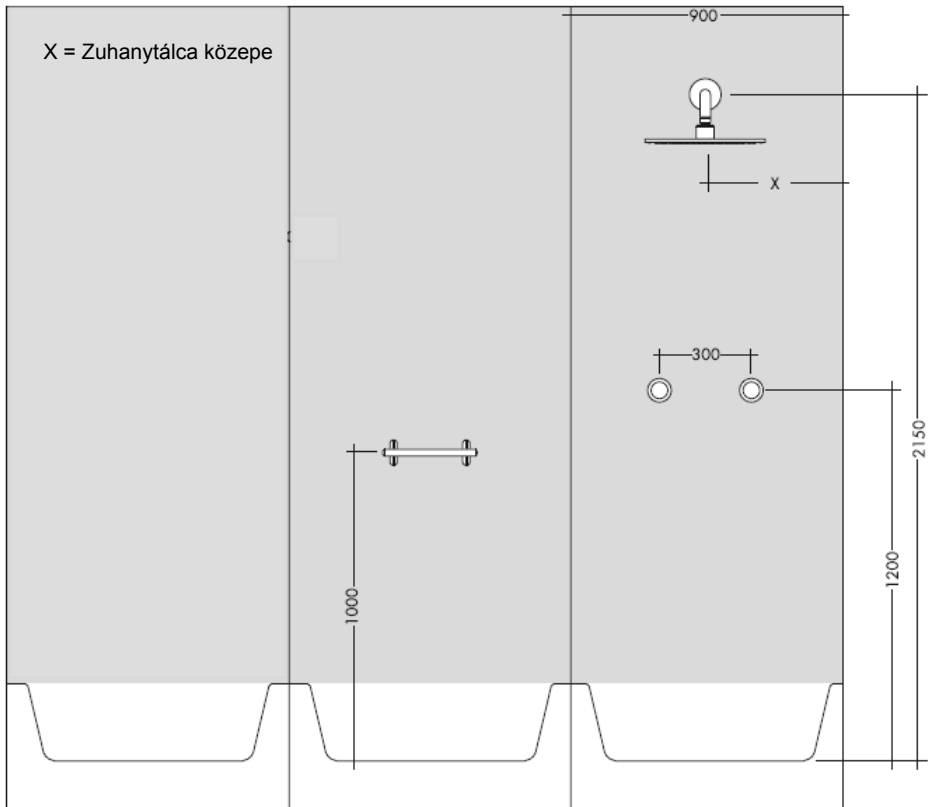

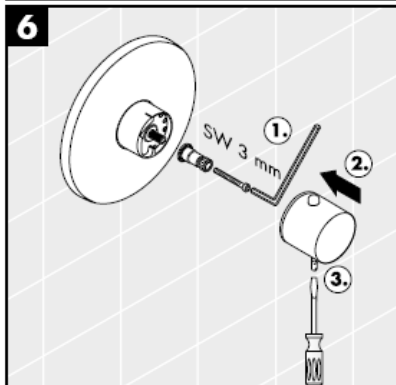
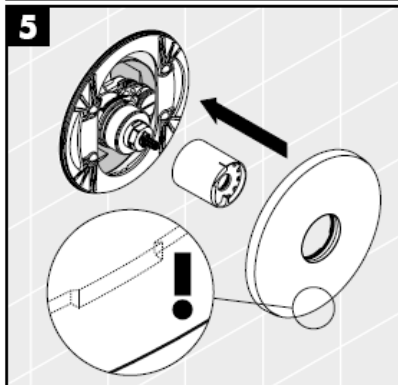
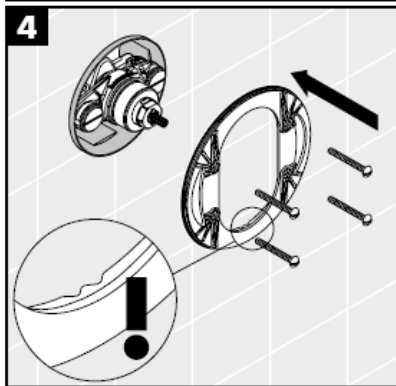
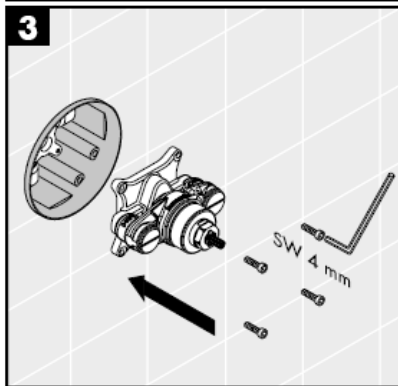
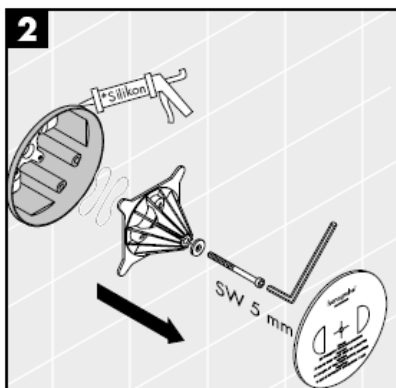
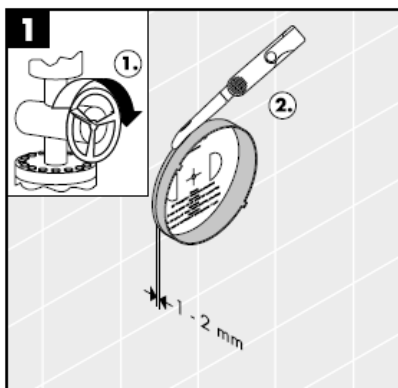

Szilikon (ecetsavmentes!)

A biztonsági funkciónak köszönhetően a kívánt hőmérsékletet pl. 42 Celsius fokban maximálhatjuk.

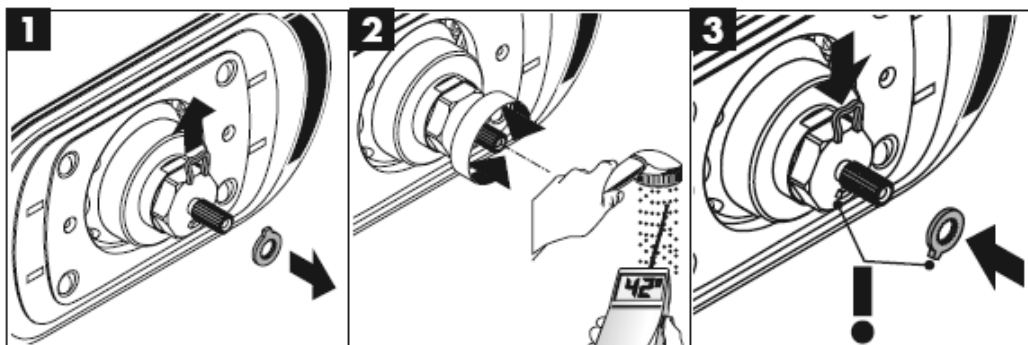

Beszereles

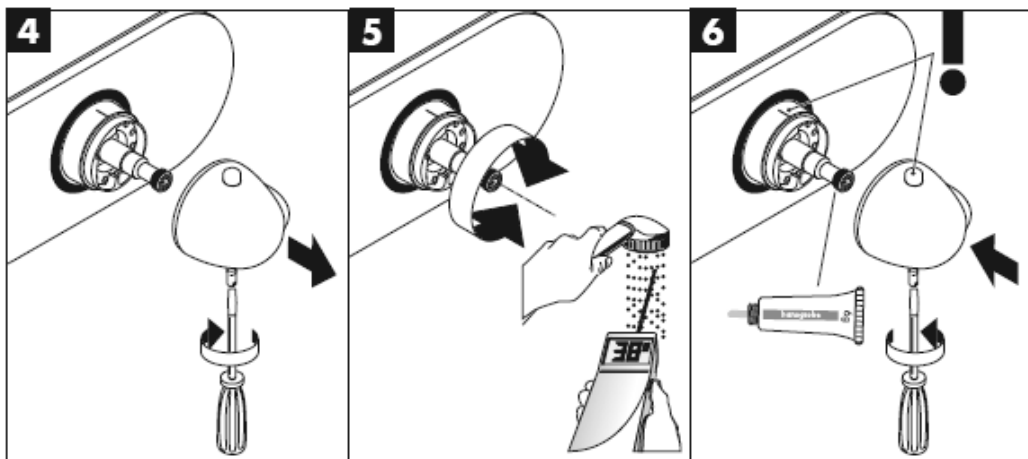



Ha a zuhany működik, akkor ennek a zuhanykarral együtt kb. 10 kg a tömege. Ezért csak a falnak megfelelő rögzítő anyagot szabad használni! A mellékelt csavarok és tiplik csak tömör falakhoz használhatók.

Csak a falazathoz alkalmas rögzítőanyag használható! A mellékelt csavarok és dübelek csak masszív falazathoz valók.

A kifolyási teljesítményt megfelelően kell dimenzionálni.

A megfelelő működést csak Hansgrohe High Flow termosztátoknak.

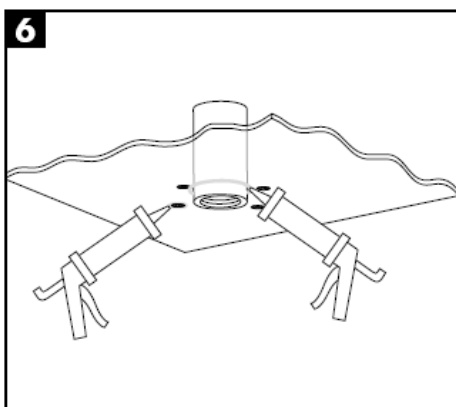
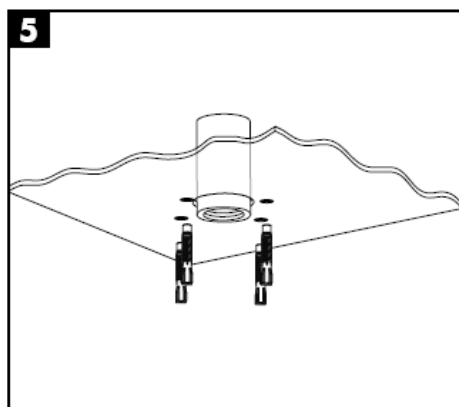
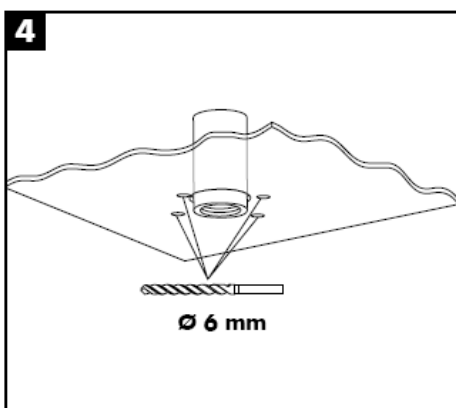
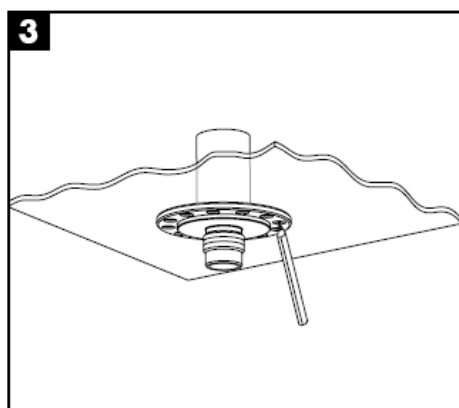
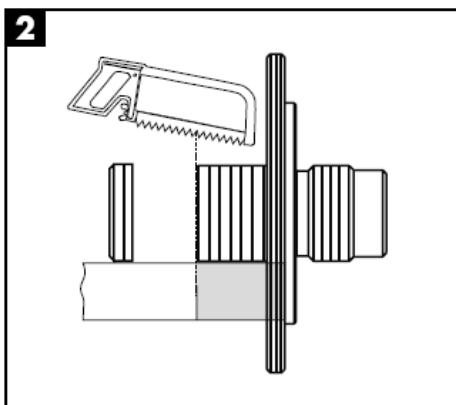
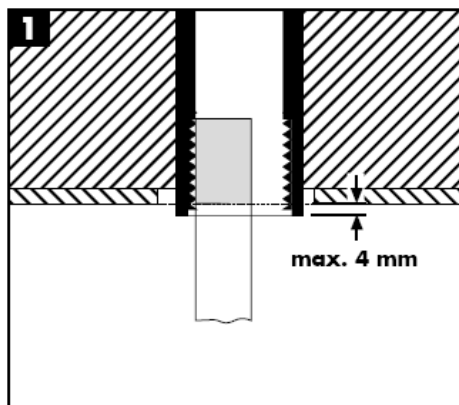

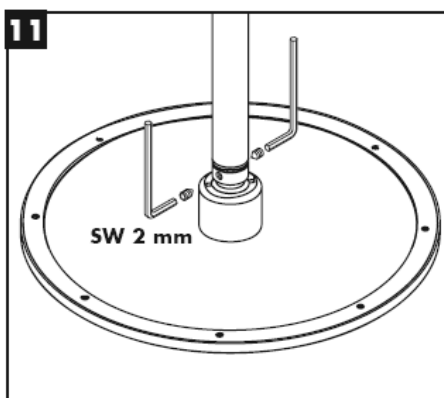
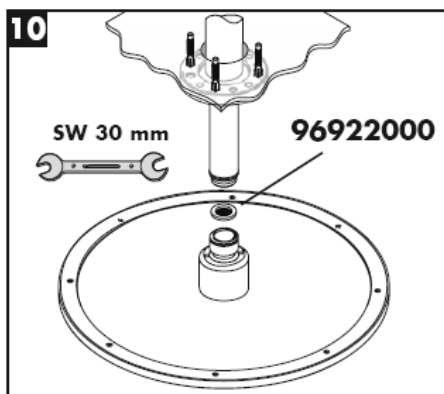
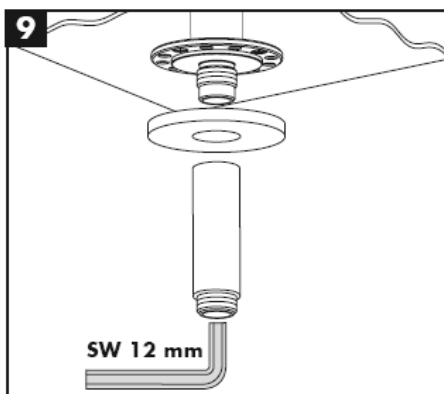
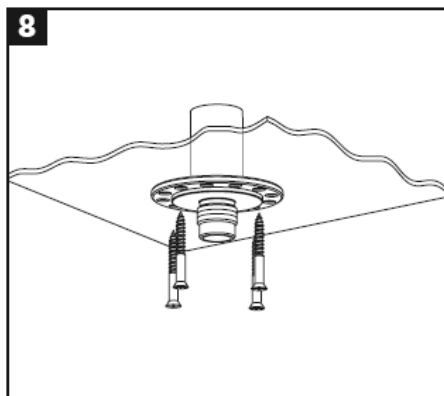
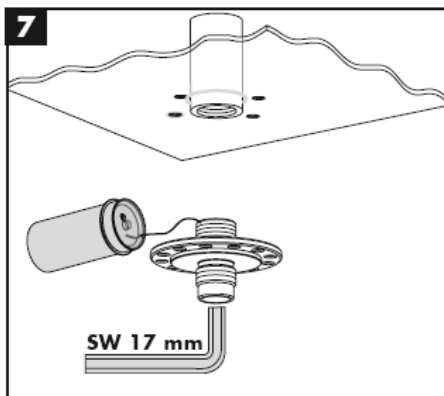

A kézi zuhanyhoz csomagolt szűrőtömítést be kell szerelni a vízhálózatból származó szennyeződések kiküszöbölésére. A beáramló szennyeződések akadályozhatják és / vagy teljesen tönkre is tehetik a zuhany funkciót. Az ezekből adódó károkért a Hansgrohe nem felel.

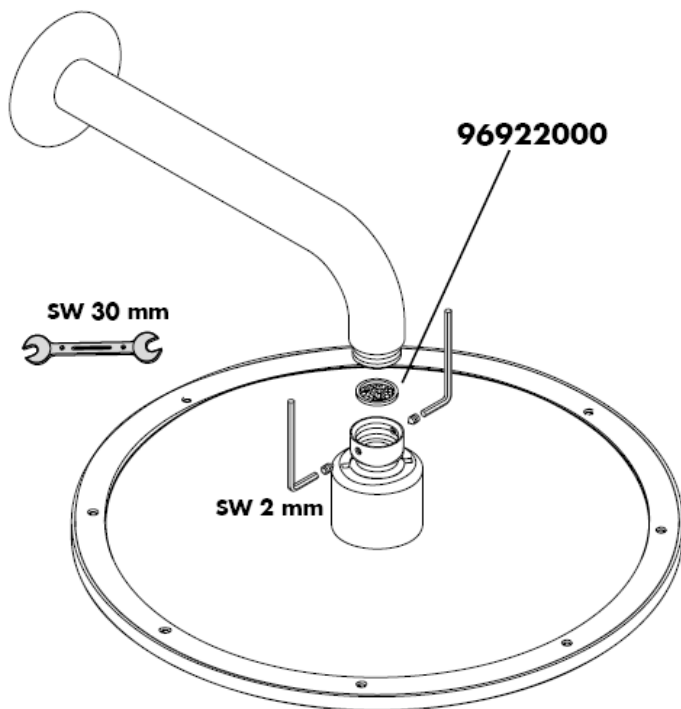

Szerelés

Figyelem! A csaptelepet az érvényben lévő előírásoknak megfelelően kell felszerelni, átöblíteni és ellenőrizni!

Beszerezés

Korrekciónak van szükség, amennyiben a kiállásnál mért hőmérséklet eltér a termosztát által mért hőfoktól. Ennek során a következőket kell figyelembe venni: Csavarjuk el a skálázott fogantyút, egészen addig, amíg a kiállási pontnál a vízhőmérséklet a 38 °C fokot el nem éri. Lazítsuk meg a fogantyúcsavart, húzzuk vissza a fogantyút és csavarjuk el a 38 °C fokos mértékig. Rögzítsük a fogantyúcsavart.

A hőmérséklet behatárolása

A hőmérséklet-tartományt a biztonsági zár segítségével 38 °C-nál korlátozzuk (forrázásvédelem). Amennyiben magasabb hőmérsékletre van szükség, a biztonsági gomb megnyomásával a 38 °C-os zár átléphető.

Safety Function (Biztonsági funkció)

A biztonsági funkciónak köszönhetően a kívánt hőmérsékletet pl. 42 Celsius fokban maximálhatjuk. lásd a oldalon 21.

Műszaki adatok

Üzemi nyomás: max. 1 MPa
Ajánlott üzemi nyomás: 0,1 – 0,5 MPa
Nyomáspróba: 1,6 MPa
(1 MPa = 10 bar = 147 PSI)
Forróvíz hőmérséklet: max. 80° C
Forróvíz javasolt hőmérséklete: 65° C
Átfolyási teljesítmény : ca. 58 l/min 0,3 MPa

Karbantartás

A termosztátoknak nem szükséges semmilyen különleges karbantartása. A visszafolyásgátlók működése a DIN EN 1717 szabványnak megfelelően, a nemzeti vagy területi rendelkezésekkel összhangban, évente egyszer ellenőrizendő! Ellenőrizze ilyenkor a szennyeződést felfogó szűrőt is, amely az MTC-szabályozóegységben (6.1) található. Az MTC-szabályozóegység (6) beszerelése után feltétlenül ellenőrizze a kifolyó víz hőmérsékletét, mint azt a „Beszabályozás” pont alatt leírtuk. Előzetesen feltétlenül ellenőrizze, hogy a melegvíz ellátás be van-e kapcsolva és hogy a melegvíz maximális hőmérséklete a csapnál rendelkezésre áll-e.

Ahhoz, hogy a szabályozóegység jól működjön, a termosztátot időről időre teljesen megrege és teljesen hidegre kell állítani.

Tartozékok lásd a oldalon 3

1	Termosztátfogantyú	38391000
2	Rozetta	96452000
3	Hüvely	97439000
4	Tartócsavarok	96454000
5	Tartórozetta	96447000
6	Hőmérséklet-szabályozóegység	96633000
7	Szűrőt tisztítani	97367000
8	Visszacsapószelep	96655000
9	Hosszabbítás 25 mm	13595000
10	Hosszabbítás 25 mm	13596000

Magyar

Hiba	Ok	Megoldás
Kevés víz	-a nyomás nem megfelelő -a szabályozóegység szennyeződést felfogó szűrője koszos -a zuhany szűrőtömitése koszos	-a vezetékek nyomását ellenőrizni kell -a szűrőt tisztítani kell -a zuhany és a cső közötti szűrőt ki kell tisztítani
Kereszfolyás, a melegvíz a csap zárt állapotában a hidegvíz vezetékbe áramlik és fordítva	-a visszafolyásgátló piszkos vagy hibás	-A visszafolyásgátló kicserélése javasolt.
A kifolyóvíz hőmérséklete nem egyezik a termosztáton beállított hőmérséklettel	-a termosztát nem lett beszabályozva -túl alacsony melegvíz hőmérséklet	-a termosztátot be kell szabályozni -a melegvíz hőmérsékletét 65 fokra kell felemelni
Nem lehetséges a hőmérséklet-szabályozás	-a hőmérséklet szabályozóegység koszos vagy vízköves -A funkcióblokkot 180 fokkal való elforgatás után beszerelni.	-Újrainstallálásnál az alapterest rosszul csatlakozik (a hideget jobbra, a meleget balra vagy 180 fokkal elforgatva kell beszerelni) -A biztonsági zár nyomógombja nem működik
a rugó hibás	-a rugót ill. a nyomógombot ki kell tisztítani és enyhén be kell zsírozni ill. ki kell cserélni -a nyomógomb vízköves	-a rugót ill. a nyomógombot ki kell tisztítani és enyhén be kell zsírozni ill. ki kell cserélni -a rugót ill. a nyomógombot ki kell tisztítani és enyhén be kell zsírozni ill. ki kell cserélni

Vizsgajel

	P-IX	DVGW	SVGW	WRSA	KIWA	ACS	NF
27070000						X	
27418XXX							
28420000						X	
28435XXX						X	

Tisztítás

Egyszerűen tiszta: a vízkő egészen könnyen ledörzsölhető a csomókról.

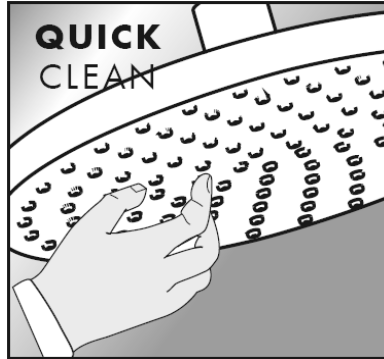

Ápolási tanácsok

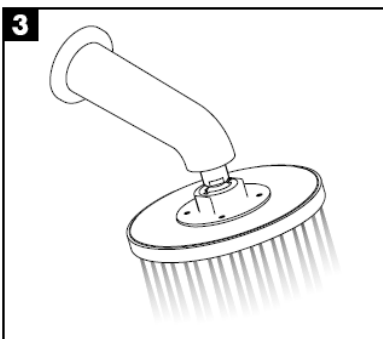
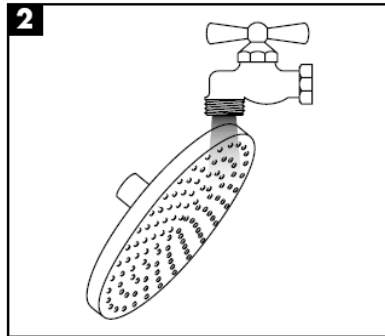
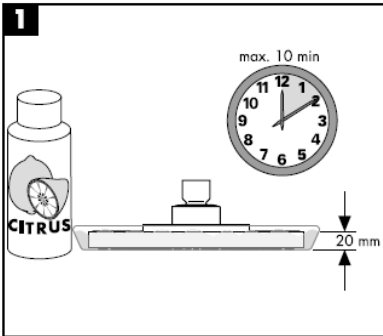

hansgrohe

Asennusohje



27418XXX

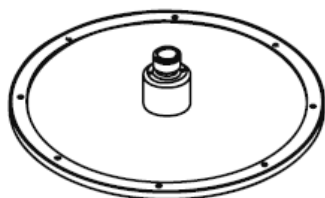

Raindance Royale AIR
28420000

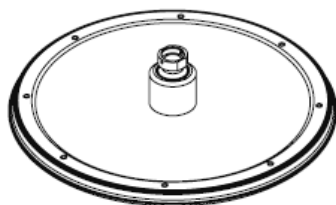

Raindance Royale Classic AIR
28435XXX

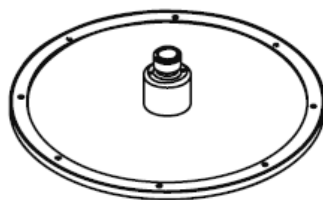

**Raindance Royale
High Flow Set**
27070000

hansgrohe

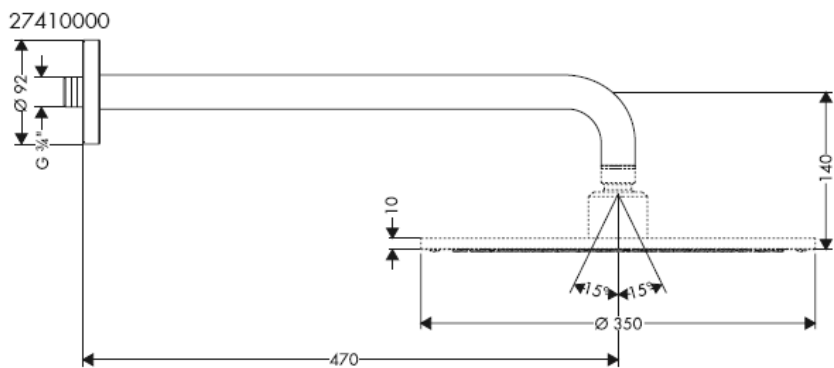
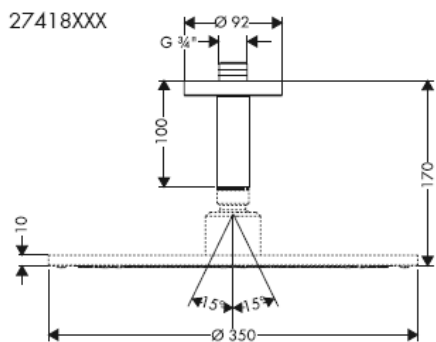
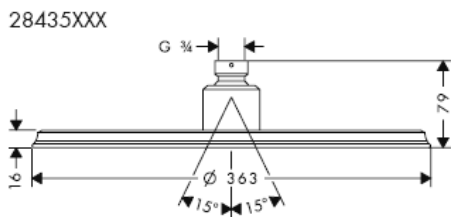
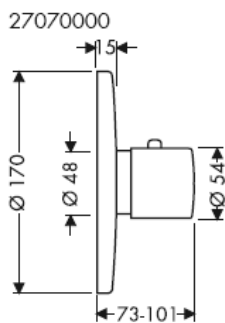
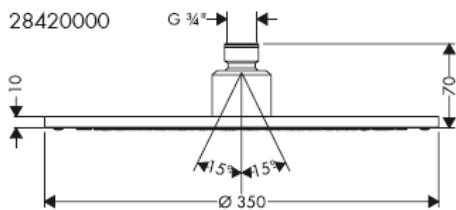

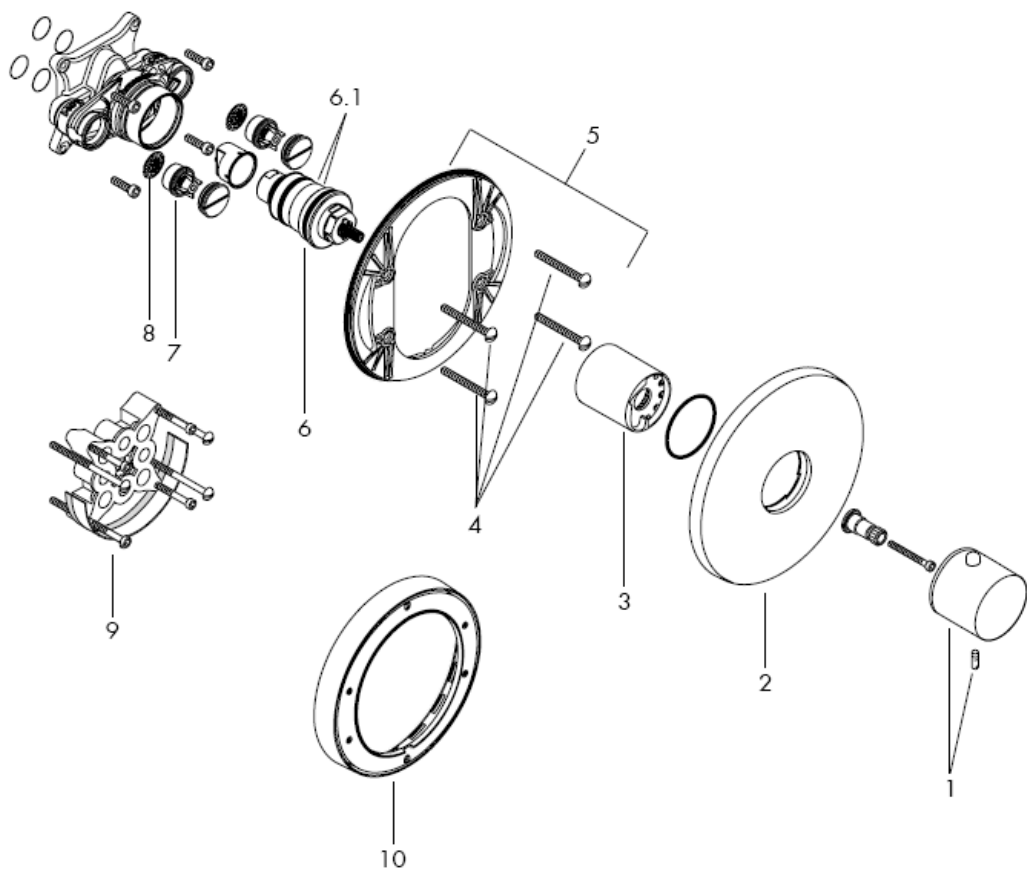

Sovita mitat mahdollisuuksien mukaan laattaruudun mukaisiksi.

Suihkuvarren kiinnittämiseen tarvitaan seinävahvistus

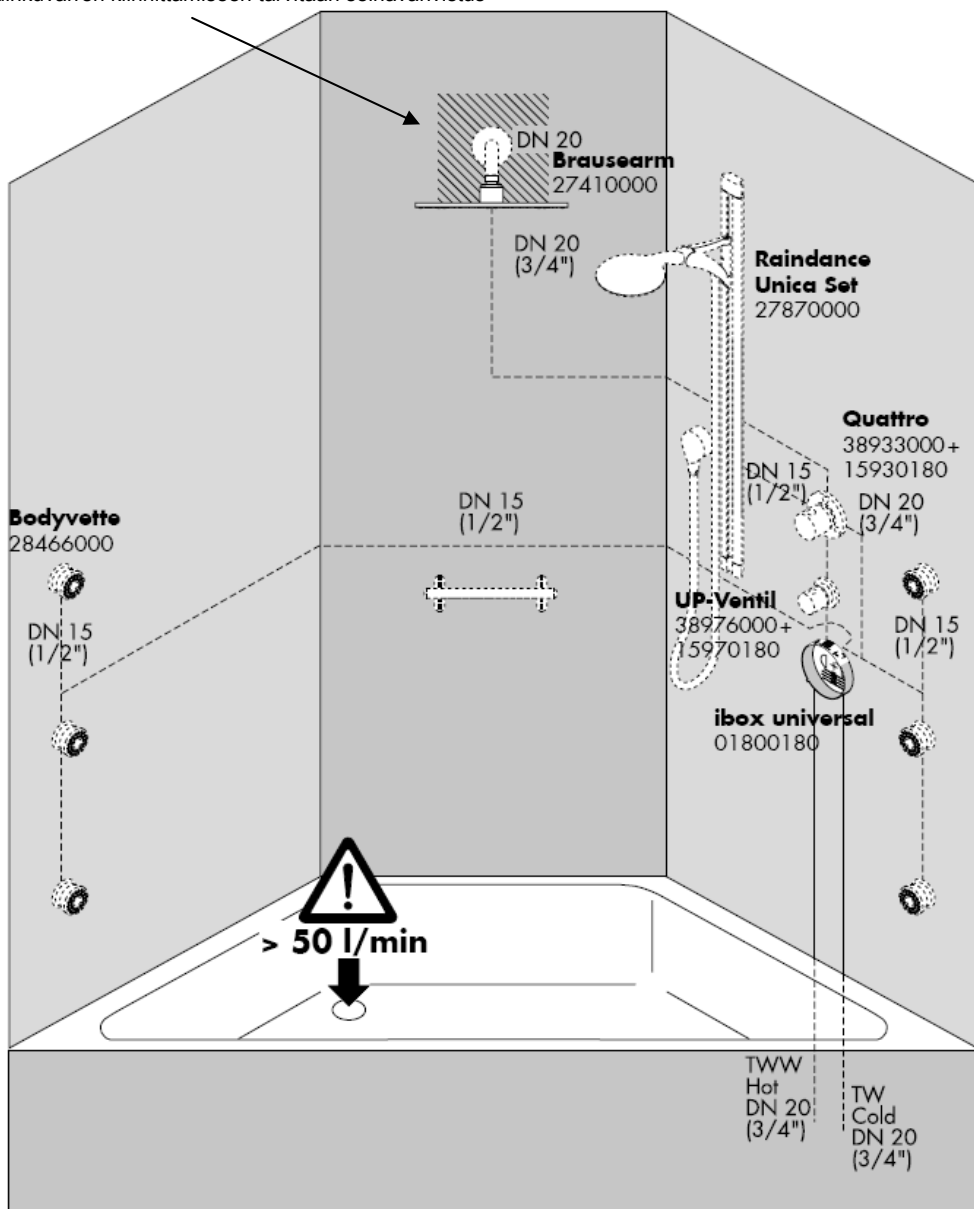

Suihkuvarren kiinnittämiseen tarvitaan seinävahvistus

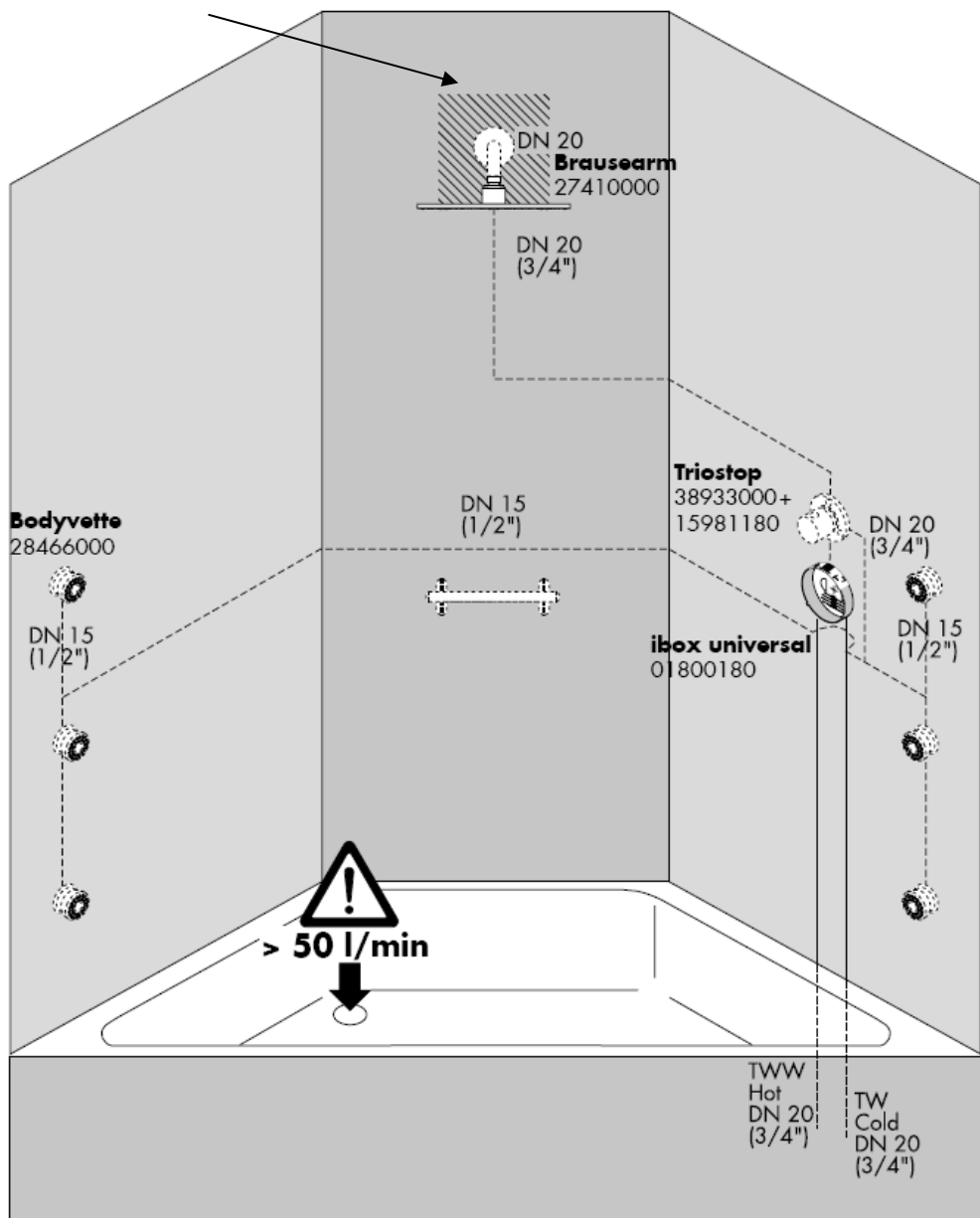

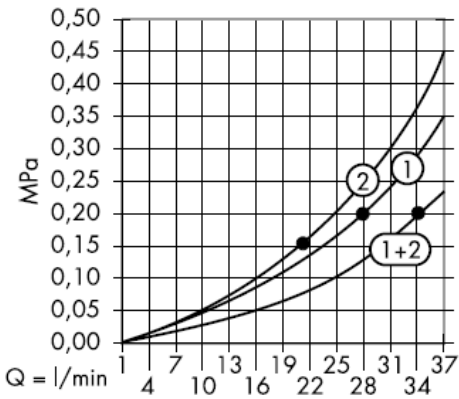

Tämä toiminta on taattuna • alkaen.

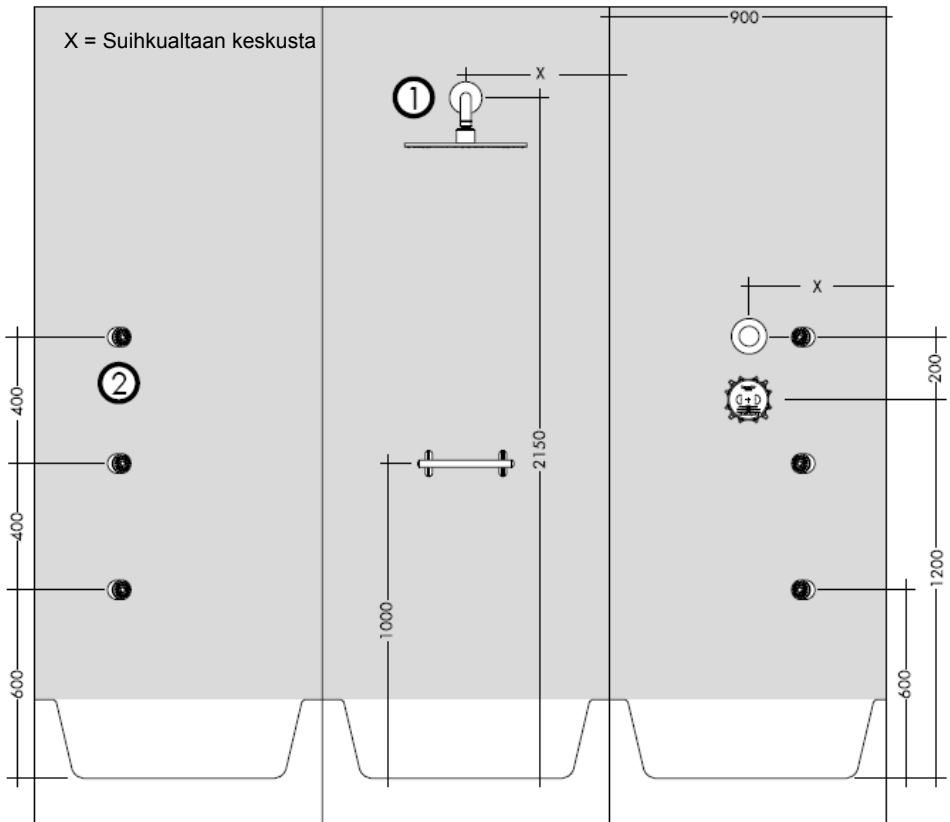

Suihkuvarren kiinnittämiseen tarvitaan seinävahvistus

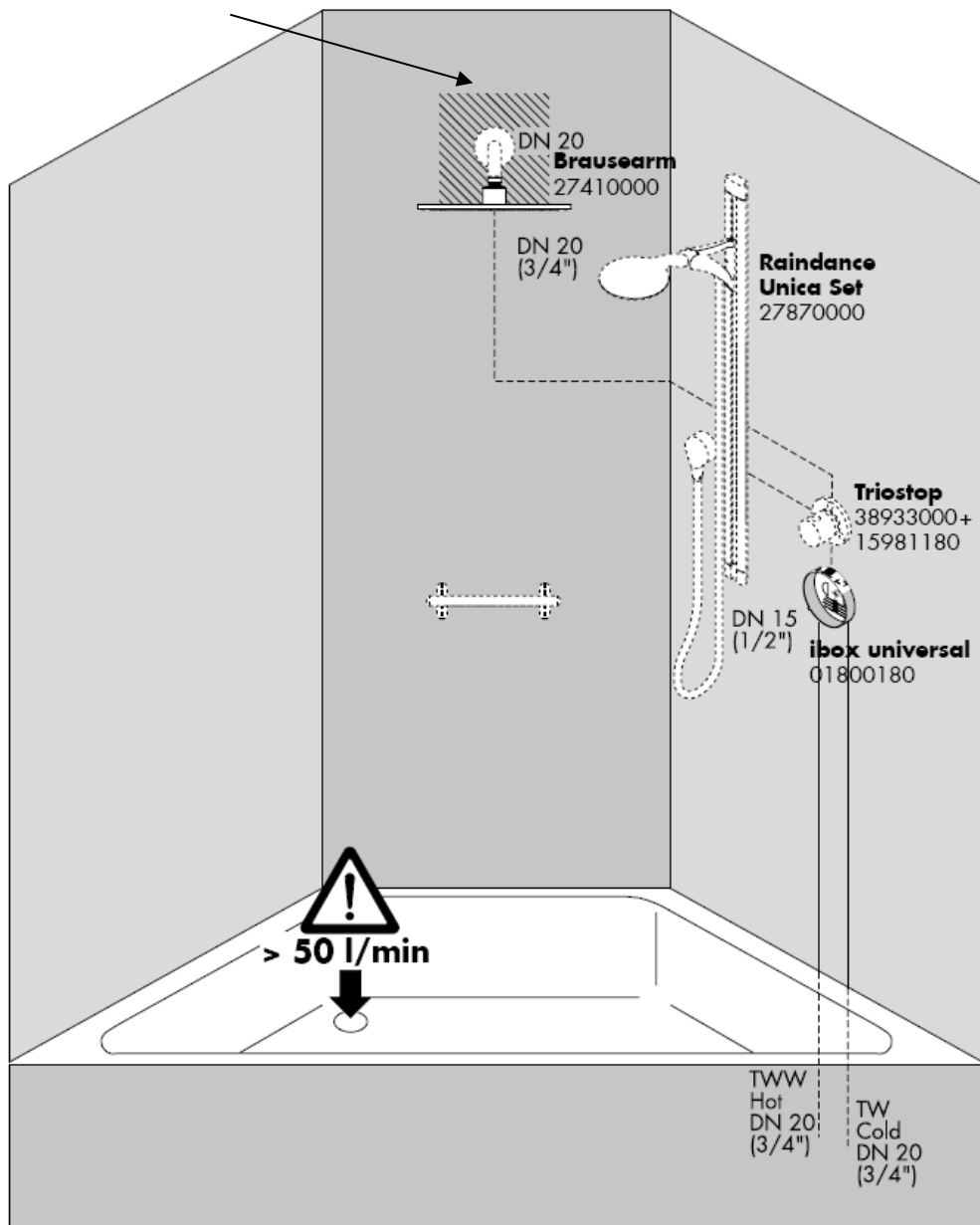

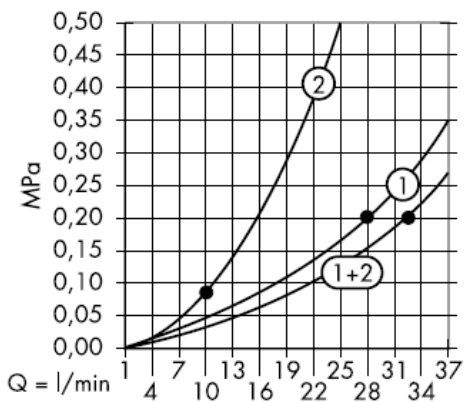

Tämä toiminta on taattuna • alkaen.

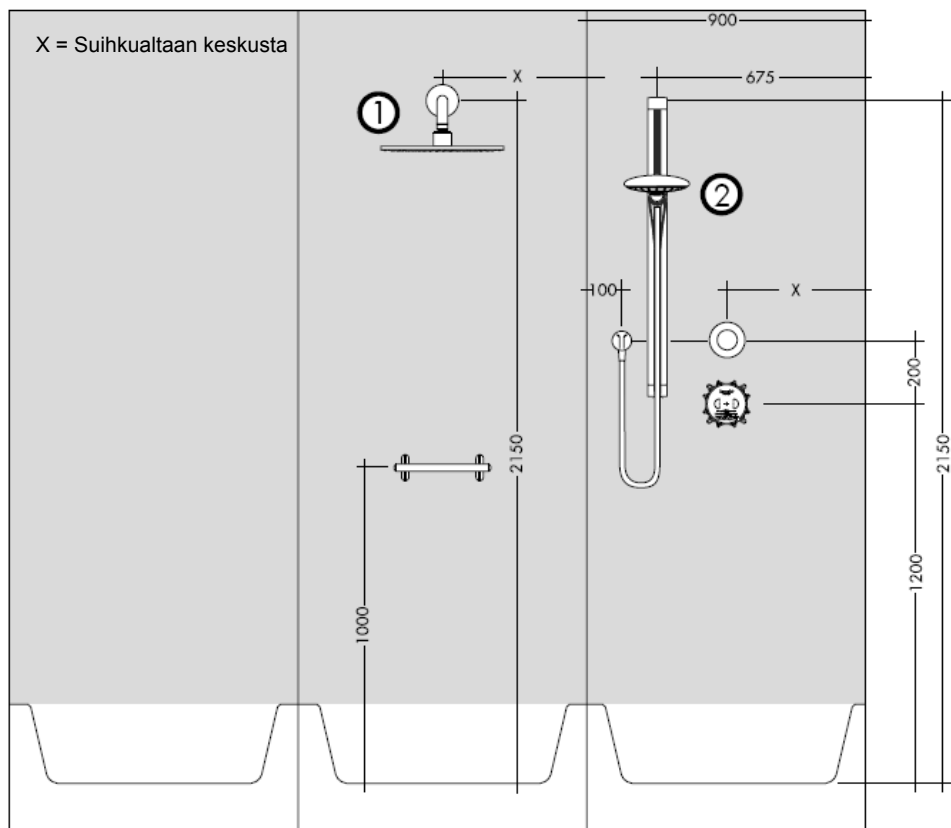

Suihkuvarren kiinnittämiseen tarvitaan seinävahvistus

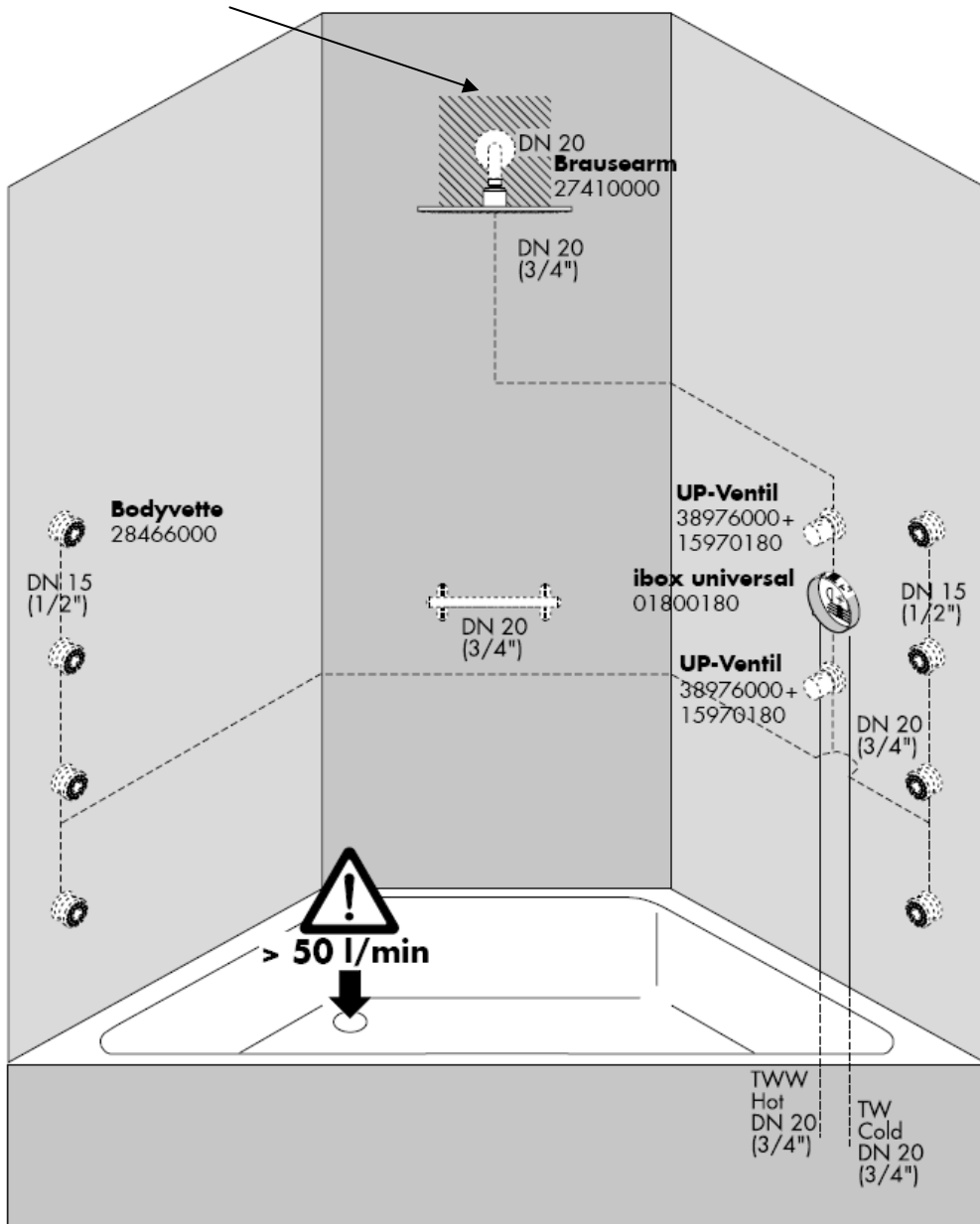

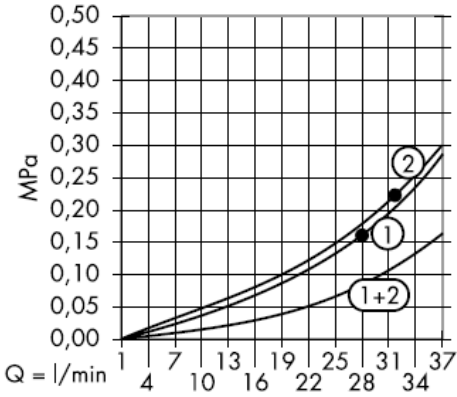

Tämä toiminta on taattuna • alkaen.

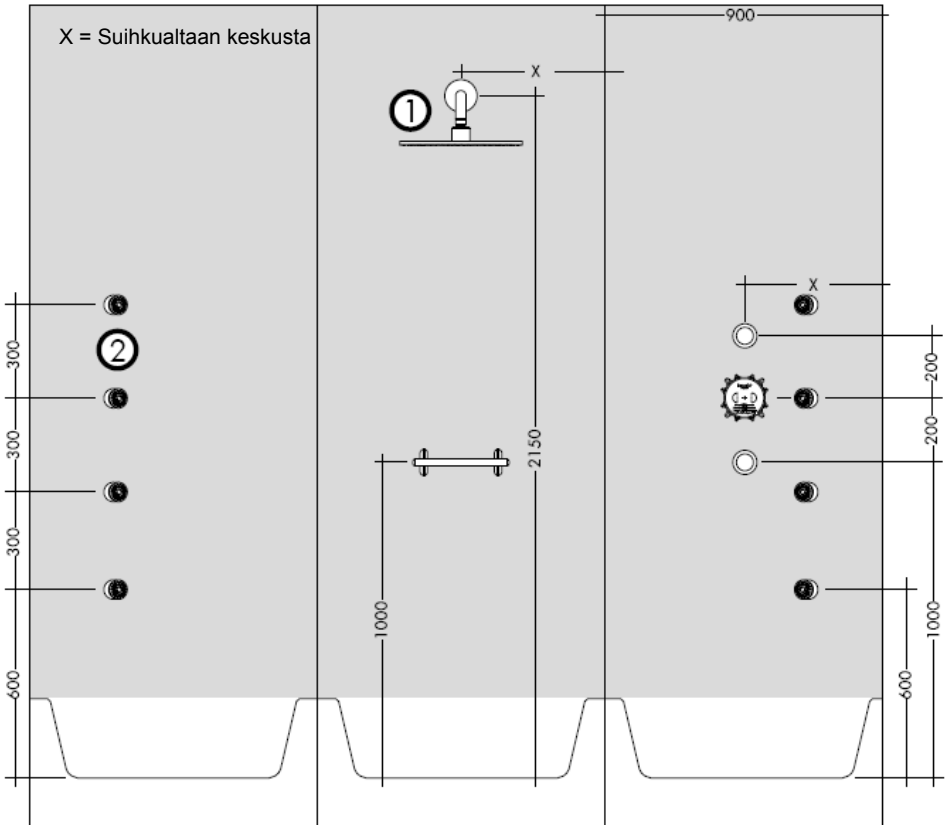

Suihkuvarren kiinnittämiseen tarvitaan seinävahvistus

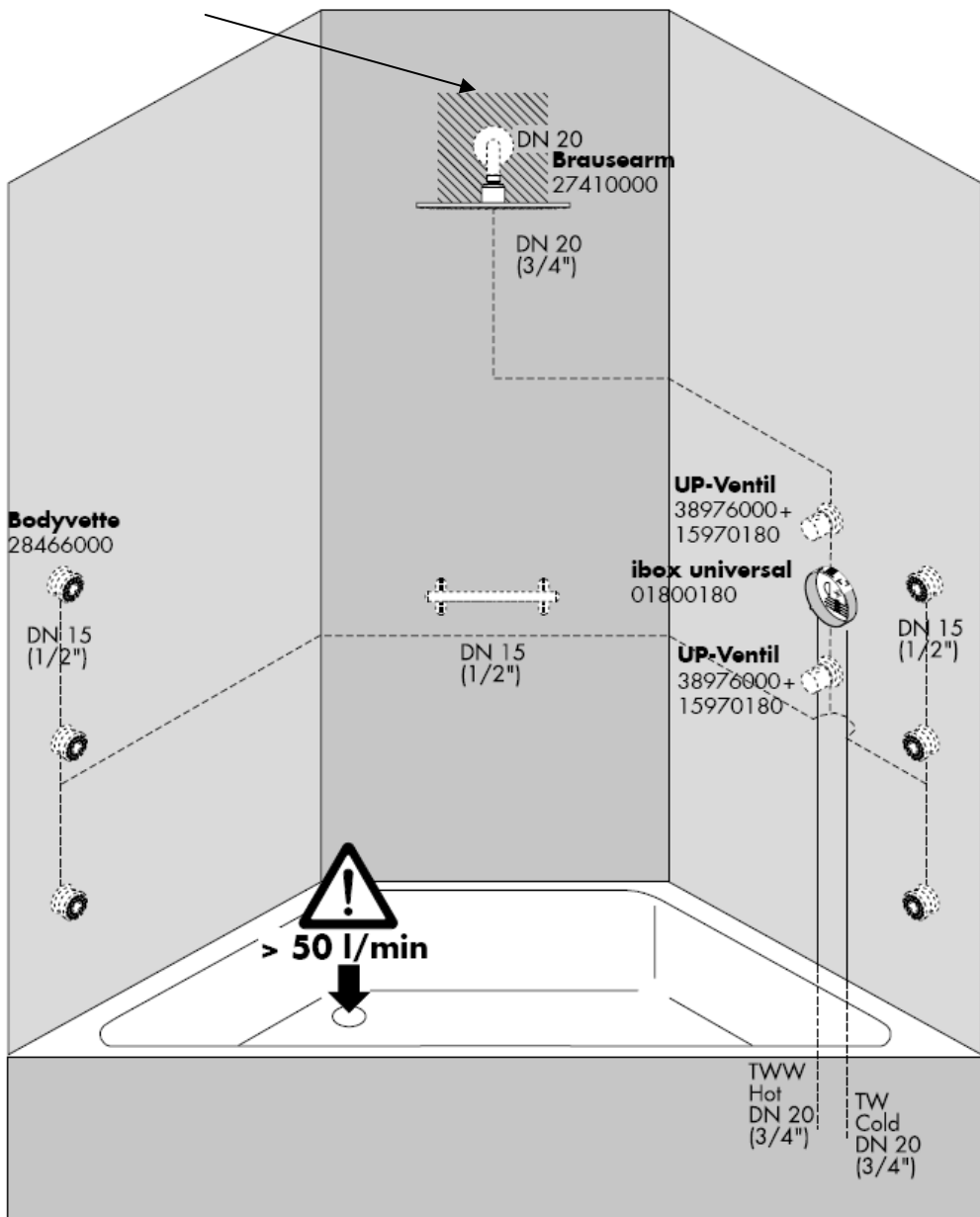

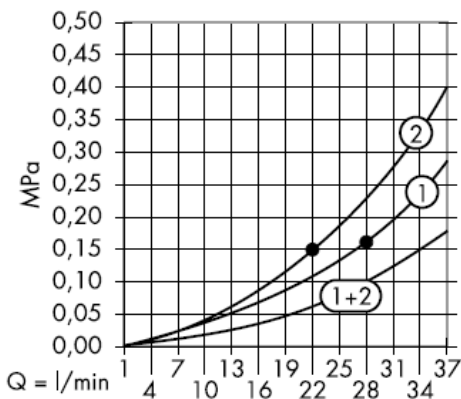

Tämä toiminta on taattuna • alkaen.

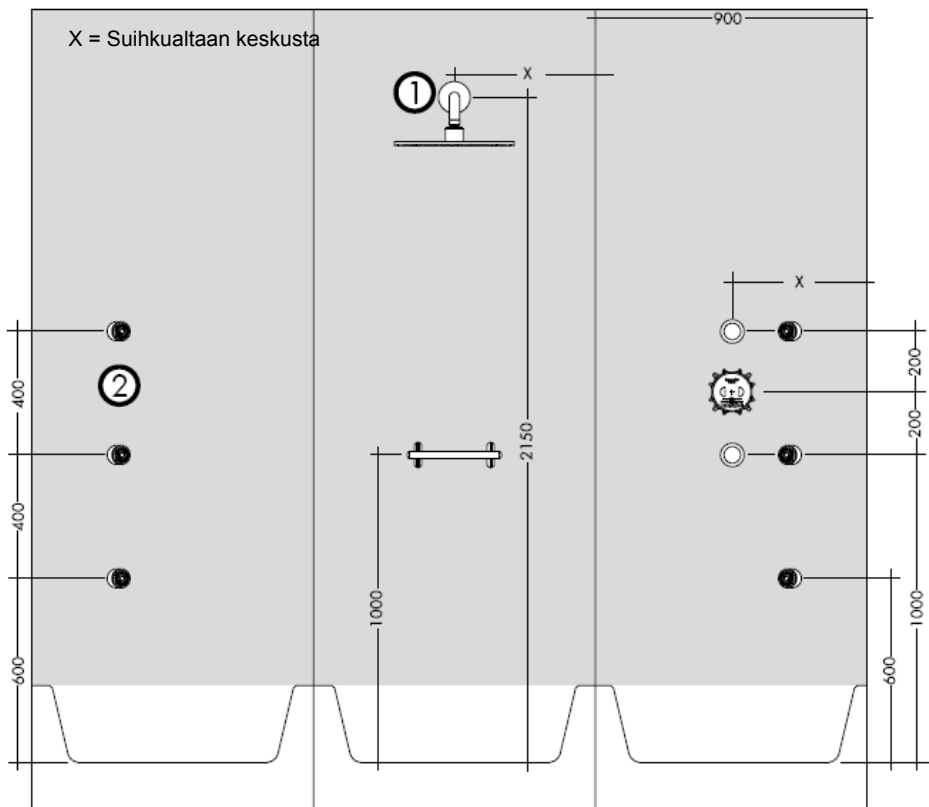

Suihkuvarren kiinnittämiseen tarvitaan seinävahvistus

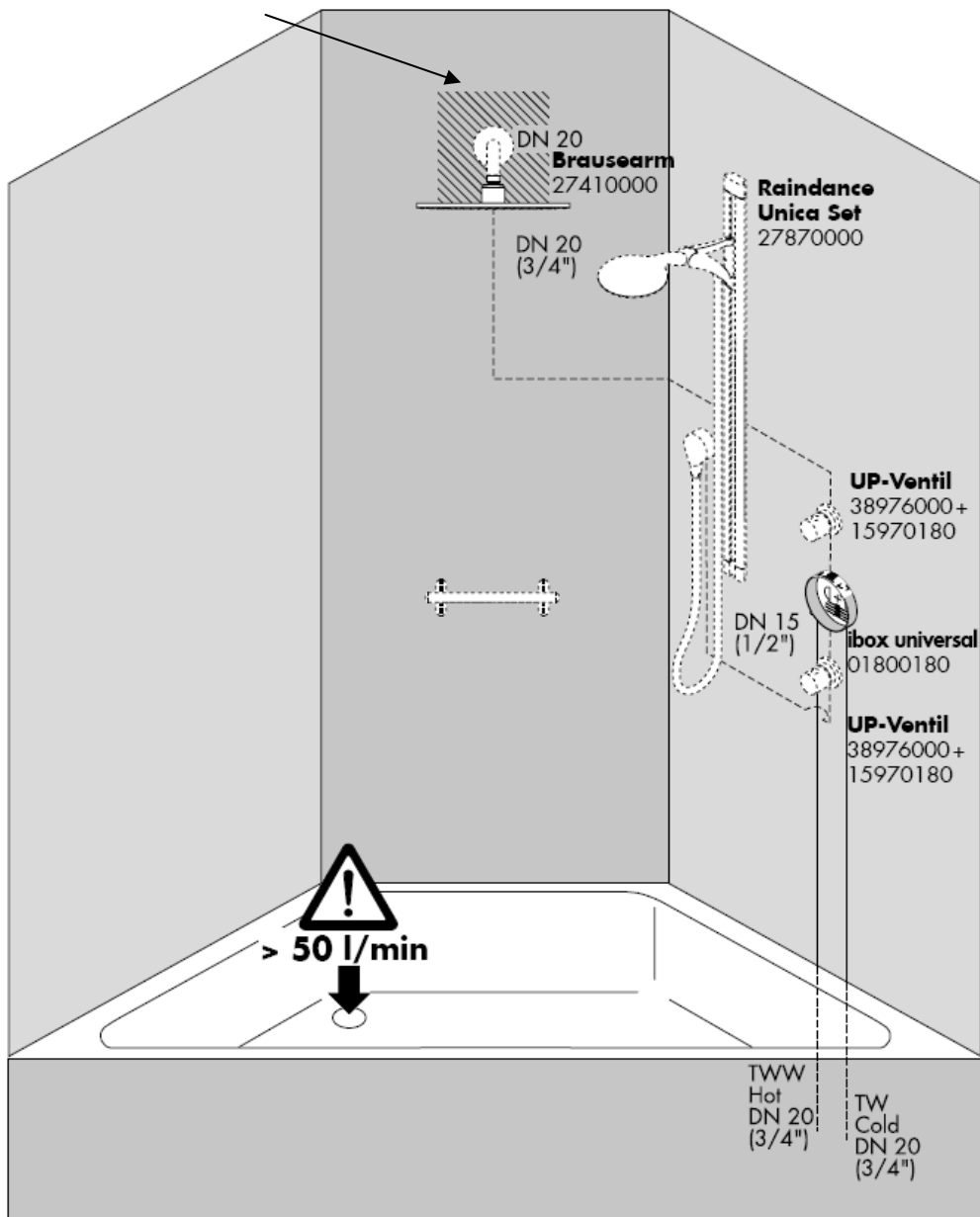

Suihkuvarren kiinnittämiseen tarvitaan seinävahvistus

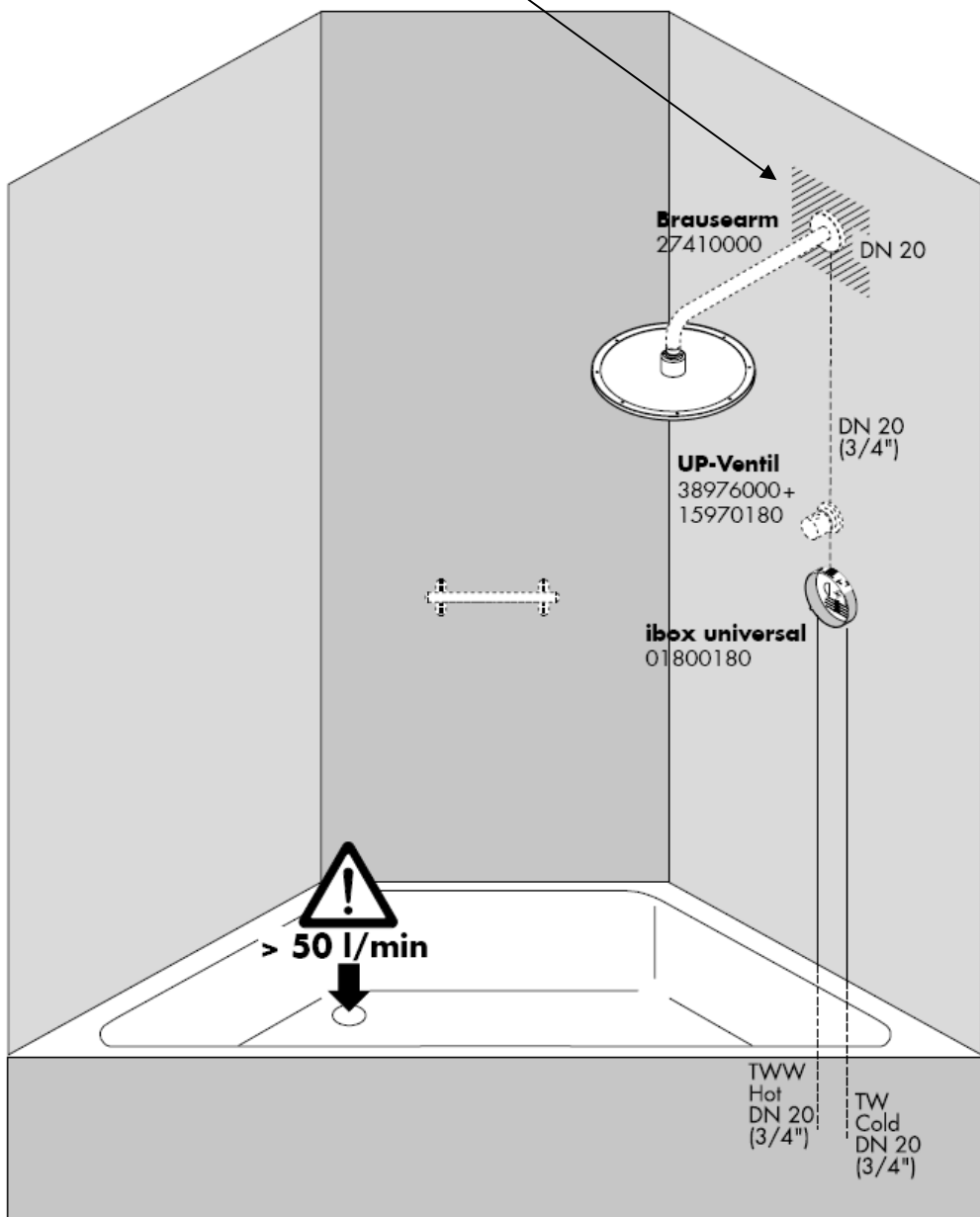

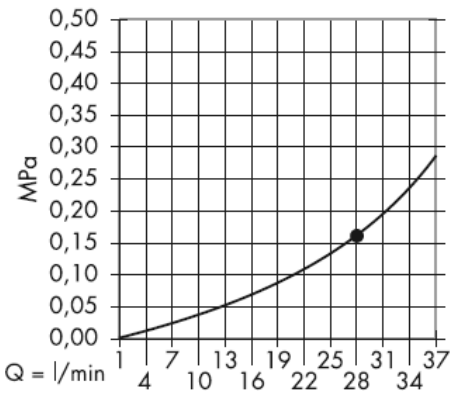

Tämä toiminta on taattuna • alkaen.

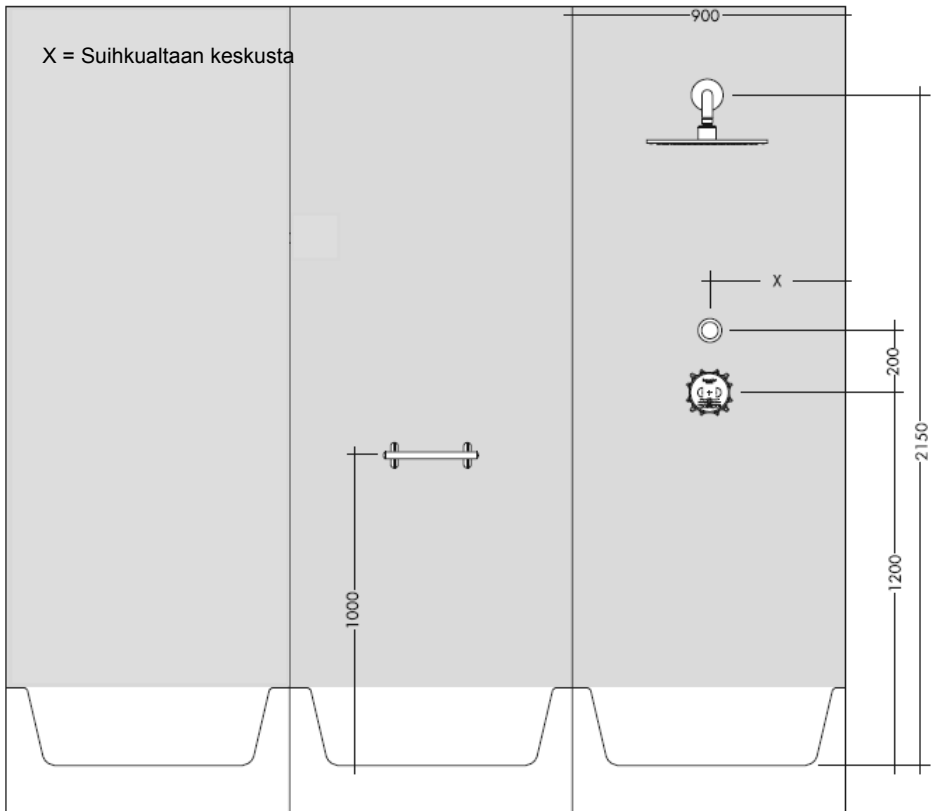

Suihkuvarren kiinnittämiseen tarvitaan seinävahvistus

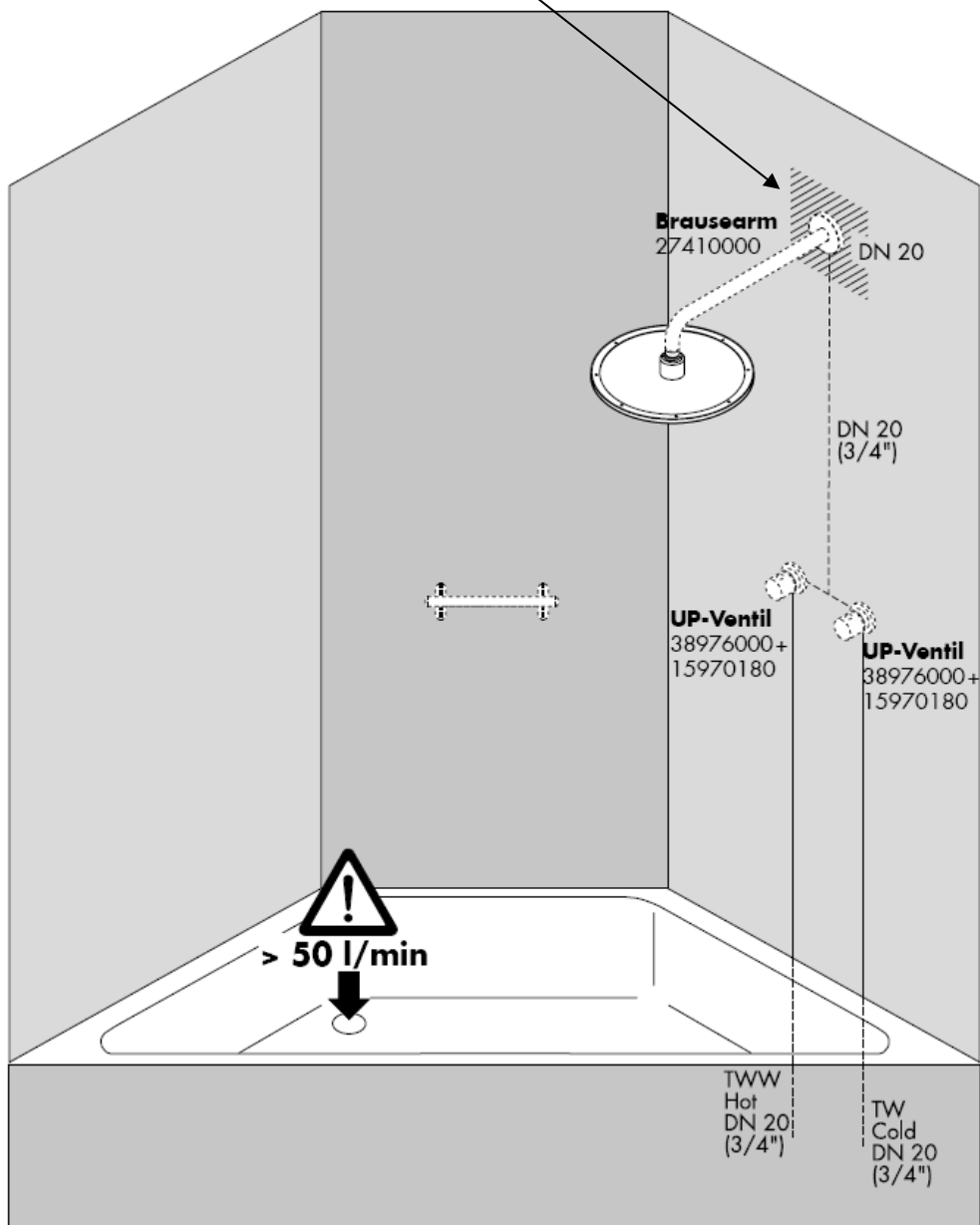

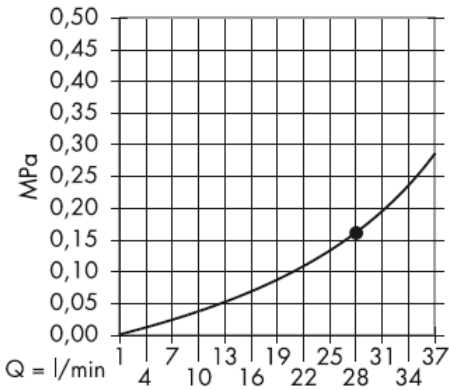

Tämä toiminta on taattuna • alkaen.

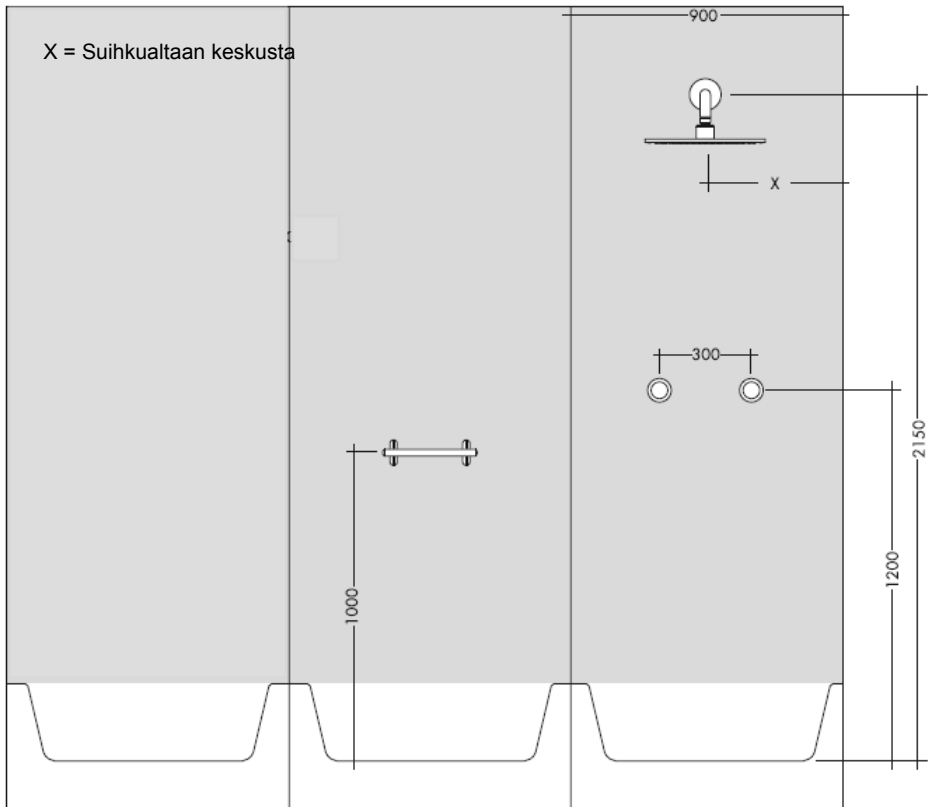

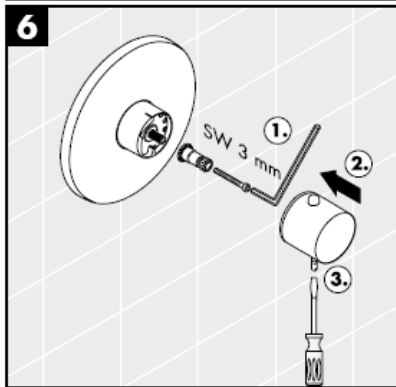
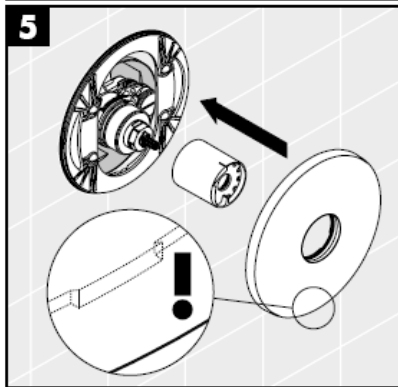
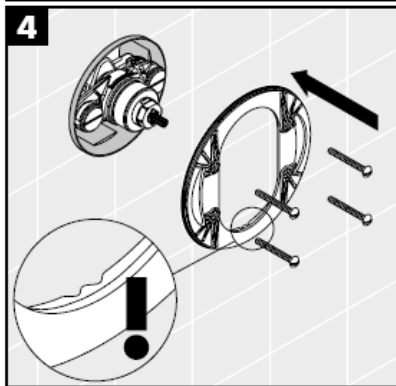
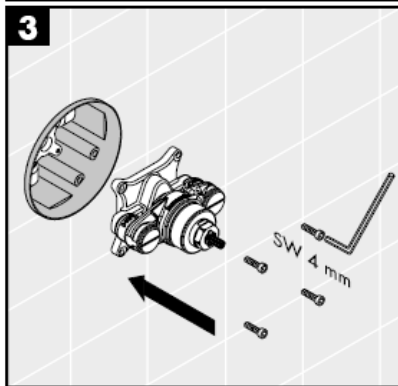
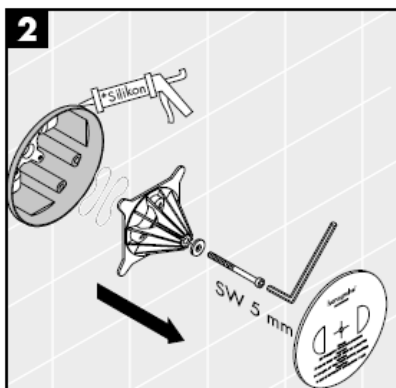
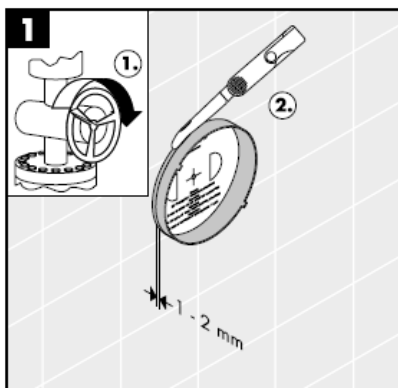

Silikoni (etikahappovapaa!)

Safety Function:ista johtuen haluttu maksimilämpötila voidaan esiasettaa, esimerkiksi maks. 42 C.

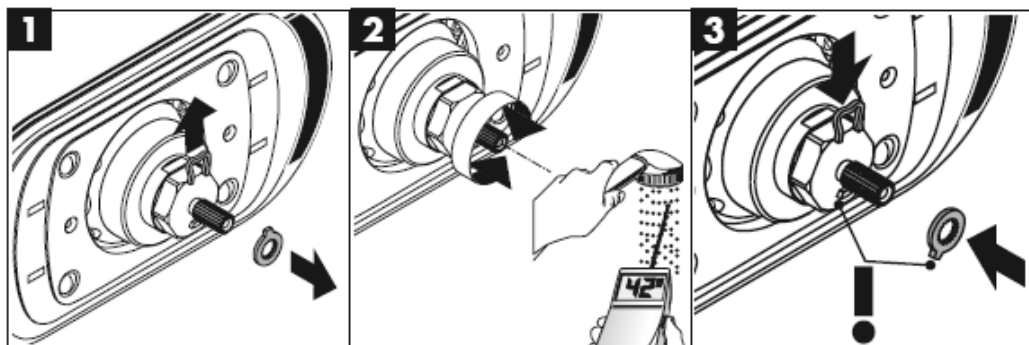

Säätö

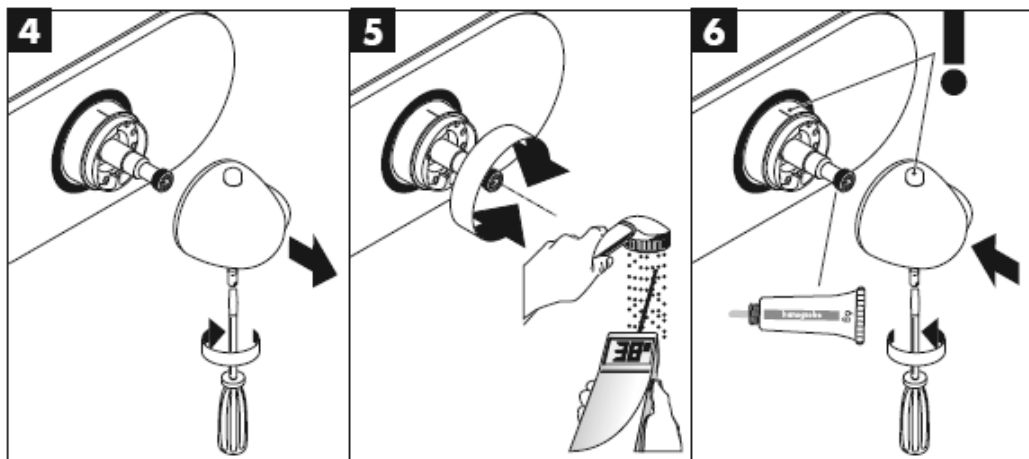



Kun suihku on toiminnassa, se painaa yhdessä suihkuvarren kanssa n. 10 kg. Siksi on käytettävä seinäpintaan soveltuvaa kiinnitysmateriaalia/-välineitä! Mukana olevat ruuvit ja kiinnitystulpat on tarkoitettu vain betoni-/täystiiliseinään.

On käytettävä vain seinämariaaliin sopivia kiinnitystarvikkeita! Mukana toimitetut ruuvit ja kiinnitystulpat soveltuvat valettuun betoniseinään.

Poisvirtausteho on mitoitettava riittävän suureksi.

Optimaalinen toiminta on taattu vain Hansgrohe High Flow -termostaattien yhteydessä.

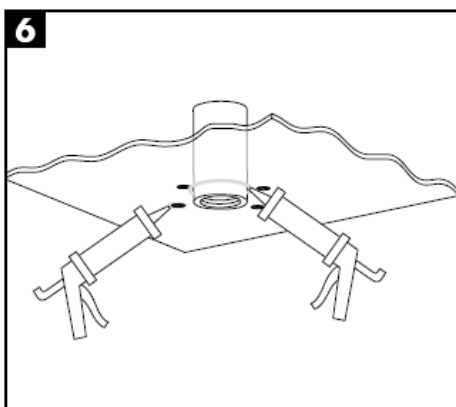
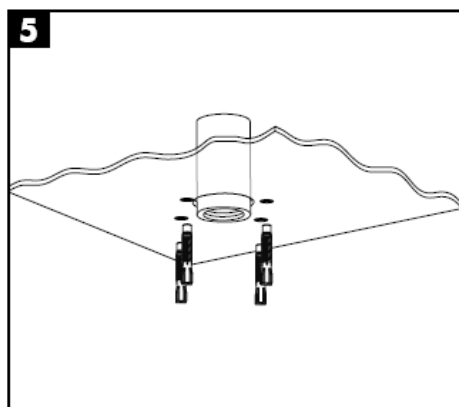
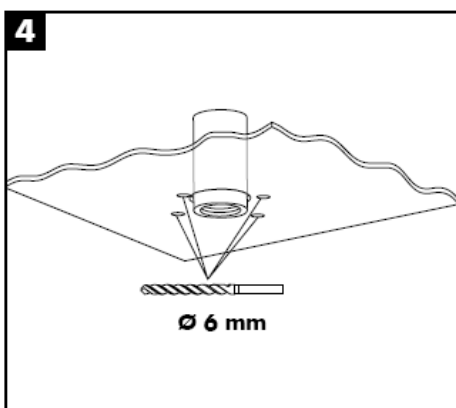
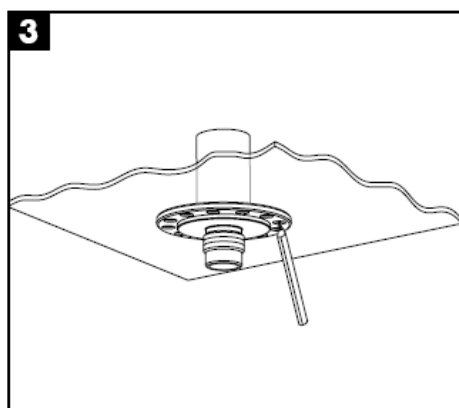
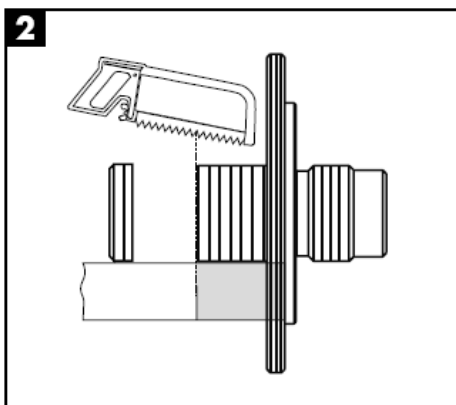
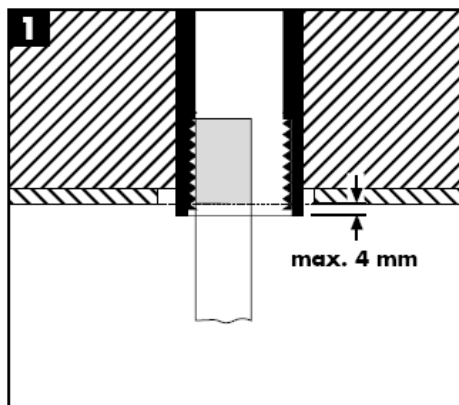

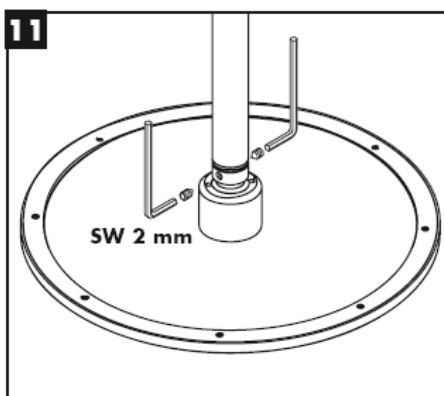
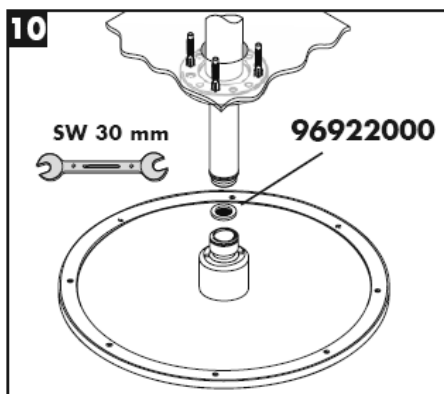
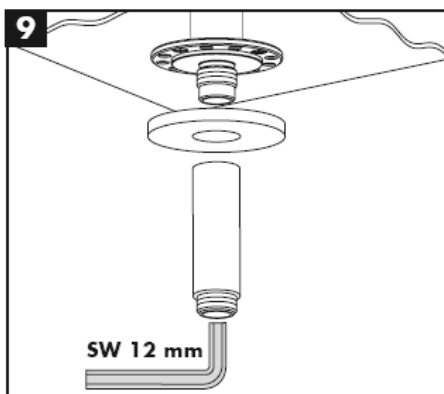
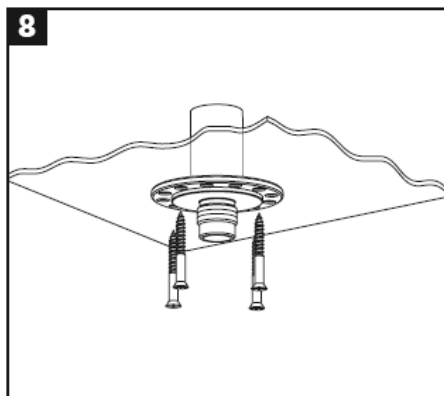
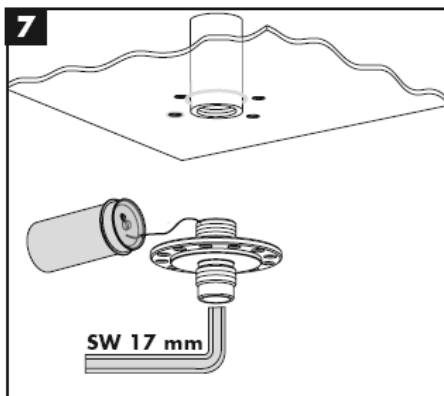

Käsisuihkun mukana toimitettu sihttiiviste on asennettava paikalleen, jotta lian huuhtoutuminen vesijohtoverkostosta käsisuihkuun estyy. Huuhtoutuvat likahiukkaset voivat häiritä suihkun toimintaa tai vahingoittaa toimintaosia, Hansgrohe ei vastaa tästä aiheutuneista vahingoista.

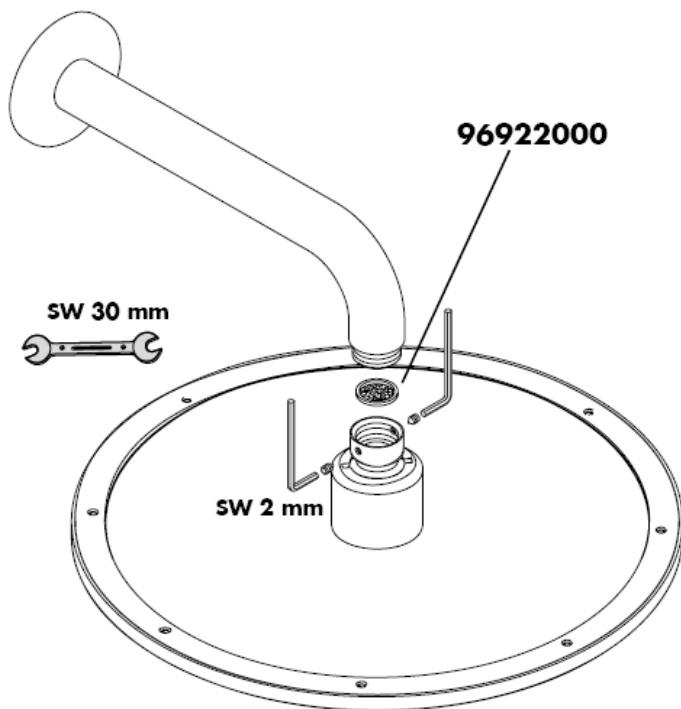

Asennus

Huomio! Kaluste on asennettava, huuhdeltava ja tarkastettava voimassa olevien määräysten mukaisesti!

Säätö

Korjaus on tarpeen, jos käyttöpisteessä mitattu veden lämpötila eroaa termostaattiin säädetyistä lämpötilasta. Toimi seuraavasti: kierrä asteikkokahvaa kunnes käyttöpisteessä veden lämpötila on 38 C. Irrota kahvan ruuvi, vedää kahvaa ulos ja käännä asentoon 38 C. Paina kahva takaisin ja kiristä kahvan kiinnitysruuvi (katso sivua 22).

Lämpötilan rajoitin

Turvaestin rajoittaa lämpötila-alueen maks. 38 C asteeseen liian kuumen veden aiheuttamien palovammojen estämiseksi. Jos halutaan korkeampaa lämpötilaa, 38 C rajoitus voidaan ohittaa painamalla turvanuppia.

Safety Function

Safety Function:ista johtuen haluttu maksimilämpötila voidaan esiasettaa, esimerkiksi maks. 42 C. katso sivu 21.

Tekniset tiedot

Käyttöpaine: max. 1 MPa
 Suositeltu käyttöpaine: 0,1 – 0,5 MPa
 Koestuspaine: 1,6 MPa
 (1 MPa = 10 bar = 147 PSI)
 Kuuman veden lämpötila: max. 80° C
 Kuuman veden suosituslämpötila: 65° C
 Läpivirtausmäärä: ca. 58 l/min 0,3 MPa

Huolto

Termostaatit eivät tarvitse mitään erityistä huoltoa. Vastaventiilien toiminta on tarkastettava säännöllisesti paikallisten ja kansallisten määräysten mukaisesti (DIN 1988, kerran vuodessa). Tarkasta tässä yhteydessä myös likasihdit, jotka ovat MTC-säätöyksikössä (6.1). MTC-säätöyksikön (6) asentamisen jälkeen ulostulevan veden lämpötila on tarkastettava kuten kohdassa "Säätö" on kuvattu. Tarkasta ehdottomasti sitä ennen, onko kuuman veden syöttö kytketty päälle ja, että syöttöpisteessä on kuuman veden maks. lämpötila.

Säätöyksikön kevytkäyttöisyyden takaamiseksi, säädä säätöyksikkö ajoittain täysin kylmälle ja täysin kuumalle.

Varaosat katso sivu 3

1	Termostaattikahva	38391000
2	Peitekaulus	96452000
3	Holkki	97439000
4	Kannatusruuvit	96454000
5	Kannatuspeiterengas	96447000
6	Lämpötilan säätöyksikkö	96633000
7	Likasihti	97367000
8	Vastaventiili	96655000
9	Pidennys 25 mm	13595000
10	Pidennys 25 mm	13596000

Suomi

Häiriö	Syy	Toimenpide
Vähän vettä	-Syöttöpaine ei ole riittävä -Lämpötilan säätöyksikön likasihti likaantunut -Käsिसuihkun sihtitiiviste likaantunut	-Tarkasta putkiston paine -Puhdista likasihdit -Puhdista suihkukahvan ja letkun välissä oleva sihtitiiviste
Ristiinvirtaus, hanan ollessa kiinni lämmin vesi pääsee virtaamaan kylmänveden putkeen tai päinvastoin.	-Suuntaisventtiili likaantunut / viallinen	-Vaihda suuntaisventtiili
Veden ulostulolämpötila ei vastaa säädettyä lämpötilaa	-Termostaattia ei ole säädetty -Lämminveden lämpötila liian alhainen	-Säädä termostaatti -Kohota lämminveden lämpötila arvoon välillä 42 C ja 65 C
Lämpötilan säätö ei ole mahdollista	-Lämpötilansäätöyksikkö likaantunut tai kalkkeutunut -Asenna toimintalohko 180 käännettynä paikalleen	-Liitokset perusrunkoon on asennettaessa tehty väärin (pitää olla: kylmä oikealla, lämmin vasemmalla) tai perusrunko on asennettu 180 -käännettynä -Veden lämpötilan turvarajoittimen painonappi ei toimi
Jousi ei toimi	-Puhdista ja voitele kevyesti jousi ja/tai painonappi, vaihda tarvittaessa -Painonappi on kalkkeutunut	-Puhdista ja voitele kevyesti jousi ja/tai painonappi, vaihda tarvittaessa -Puhdista ja voitele kevyesti jousi ja/tai painonappi, vaihda tarvittaessa

Koestusmerkki

	P-IX	DVGW	SVGW	WRSA	KIWA	ACS	NF
27070000						X	
27418XXX							
28420000						X	
28435XXX						X	

Puhdistus

Yksinkertaisesti puhdas: kalkin voi helposti hieroa irti nyyyistä.

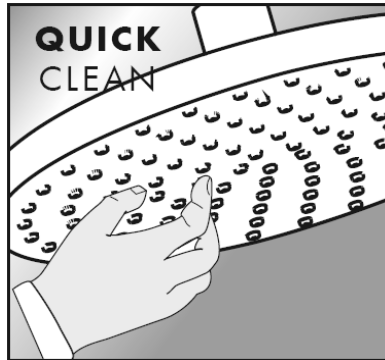

Hoito-ohje

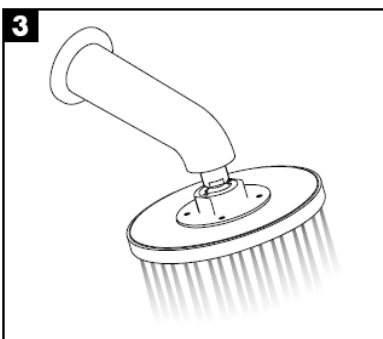
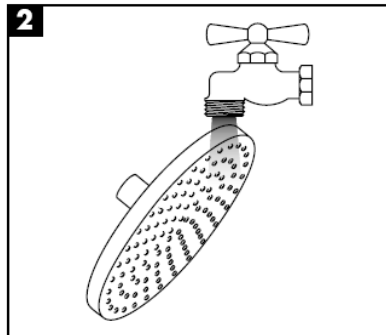
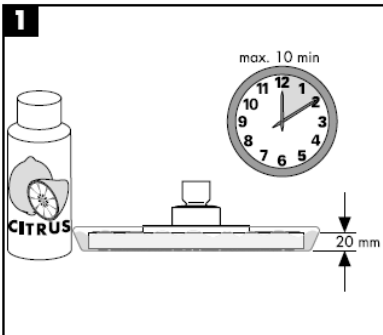

hansgrohe

Monteringsanvisning



27418XXX

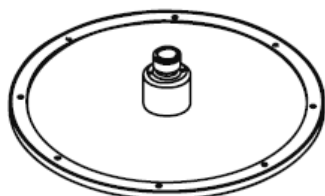

Raindance Royale AIR
28420000

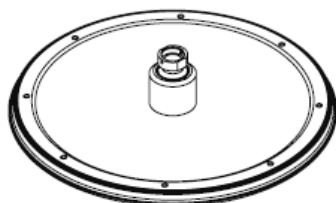

Raindance Royale Classic AIR
28435XXX

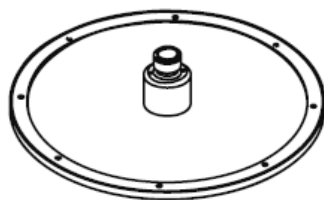

**Raindance Royale
High Flow Set**
27070000

hangrohe

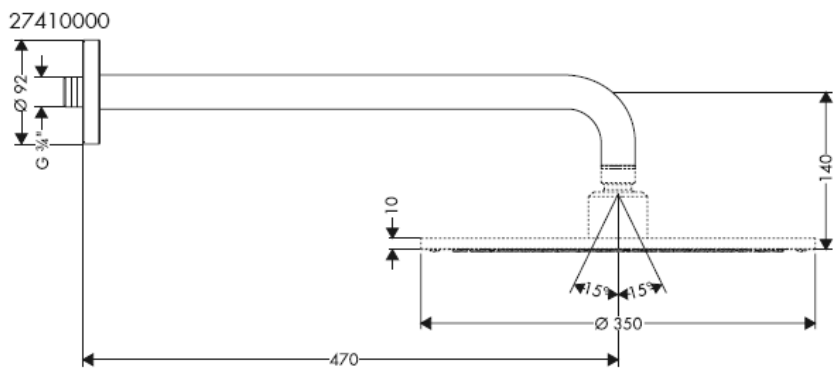
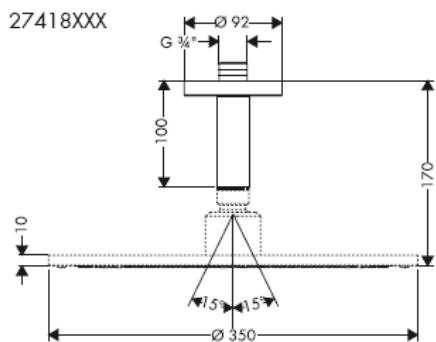
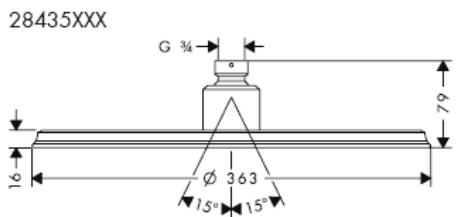
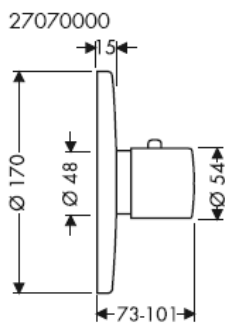
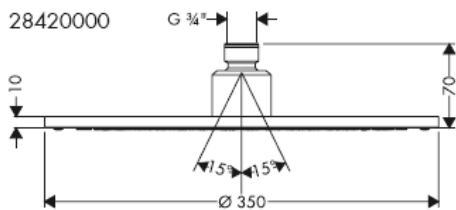

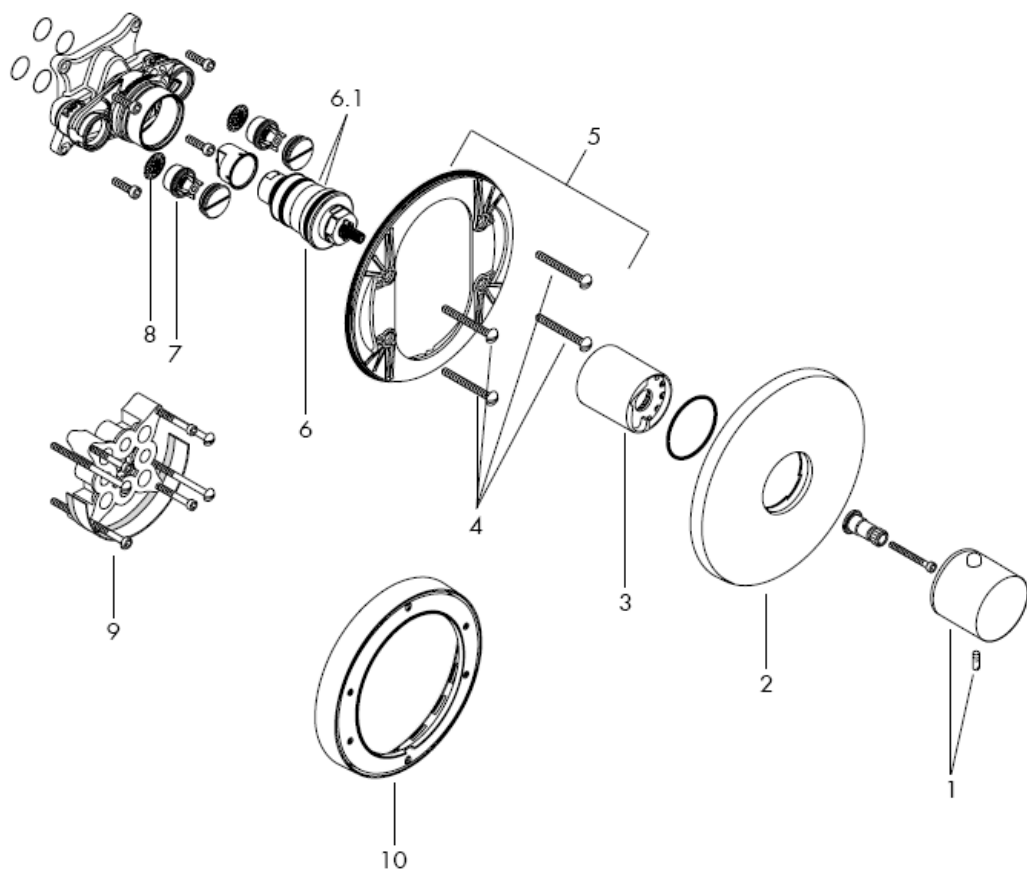

Anpassa måtten till kakelmönstret så långt detta är möjligt.

Väggförstärkning nödvändig för duscharmsmontering

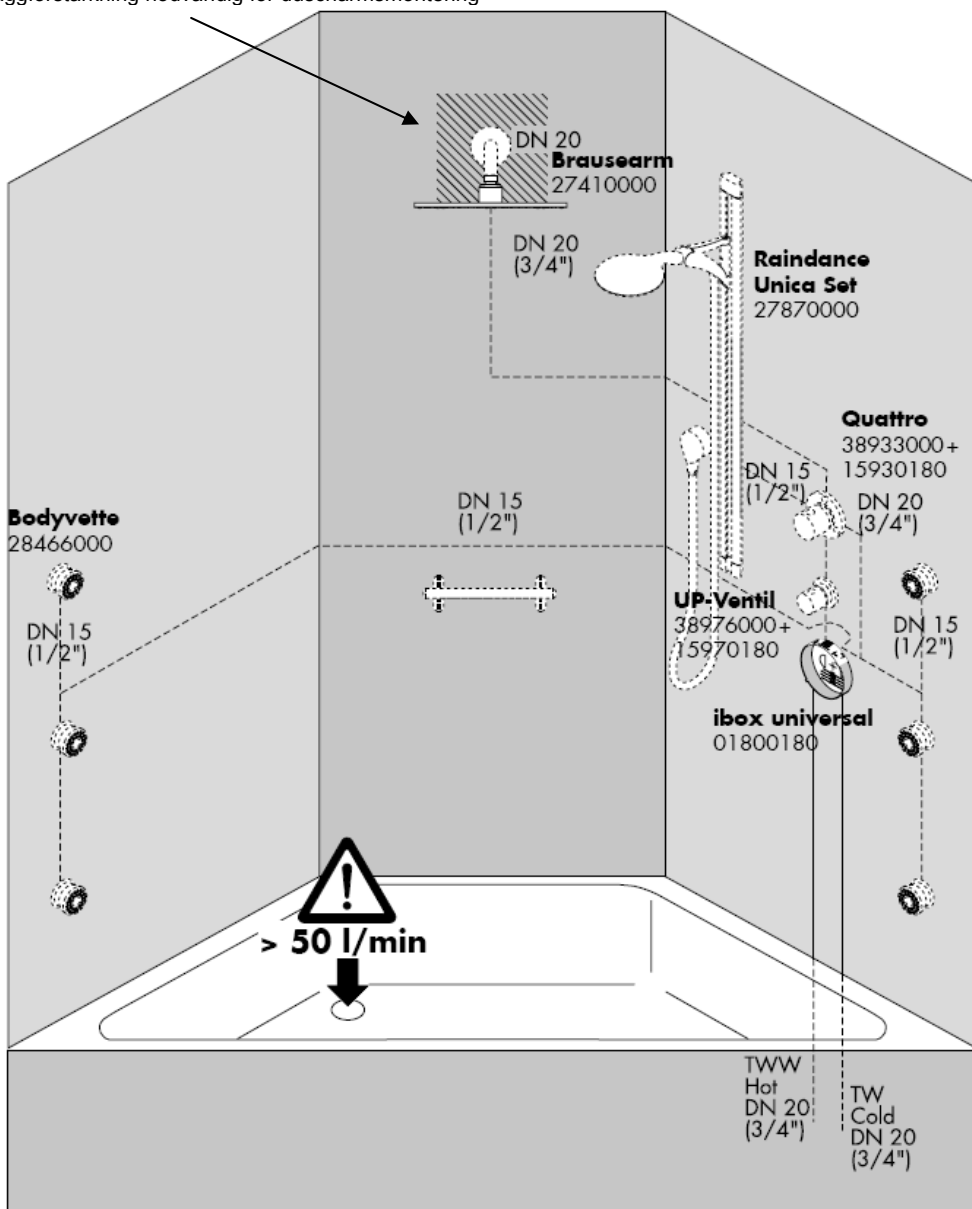

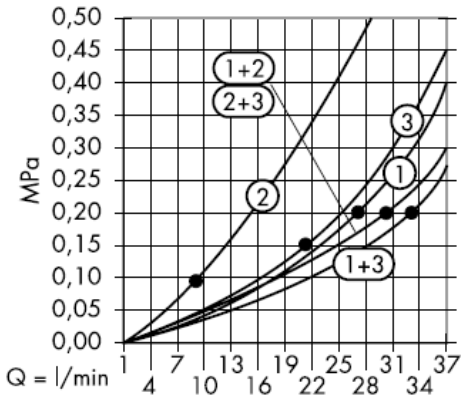

Från • garanteras funktionen.

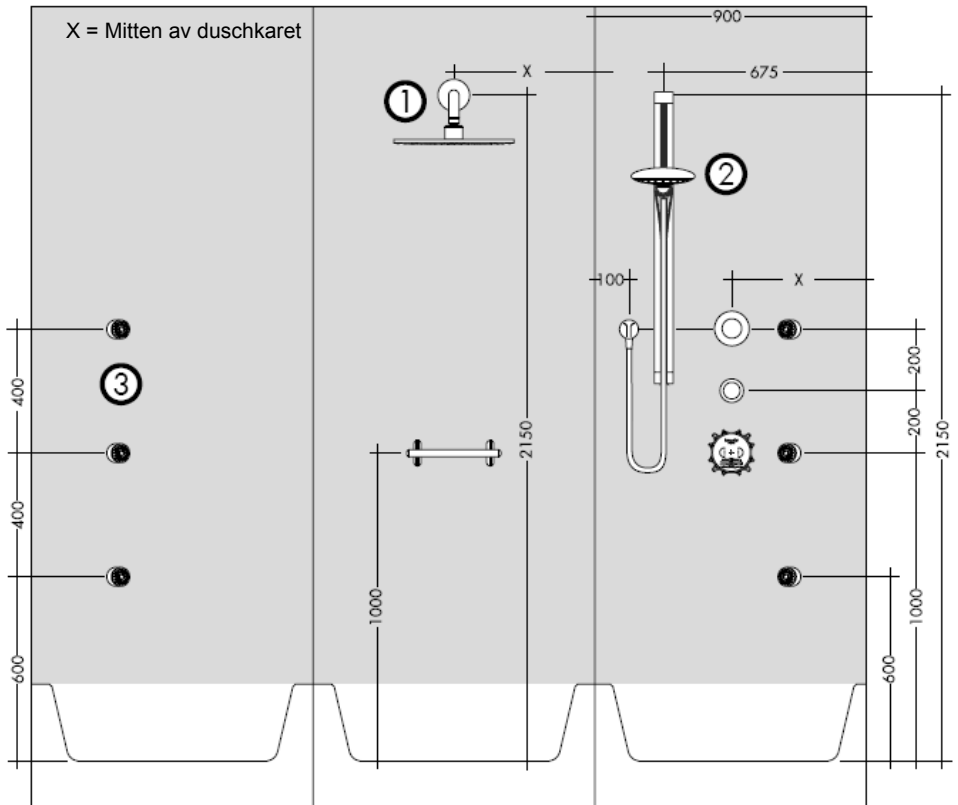

Väggförstärkning nödvändig för duscharsmontering

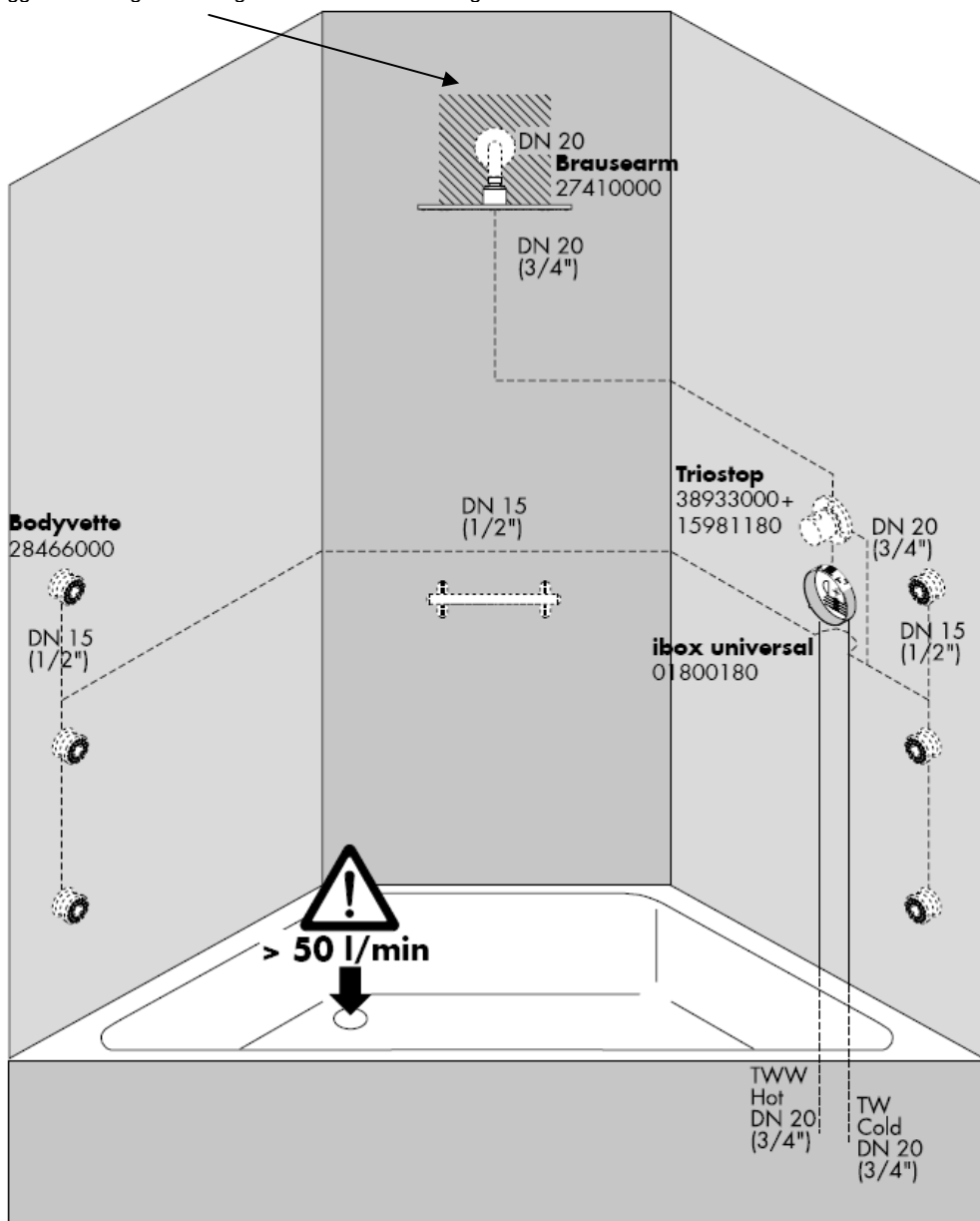

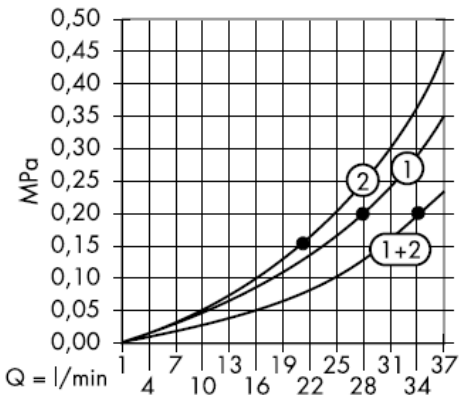

Från • garanteras funktionen.

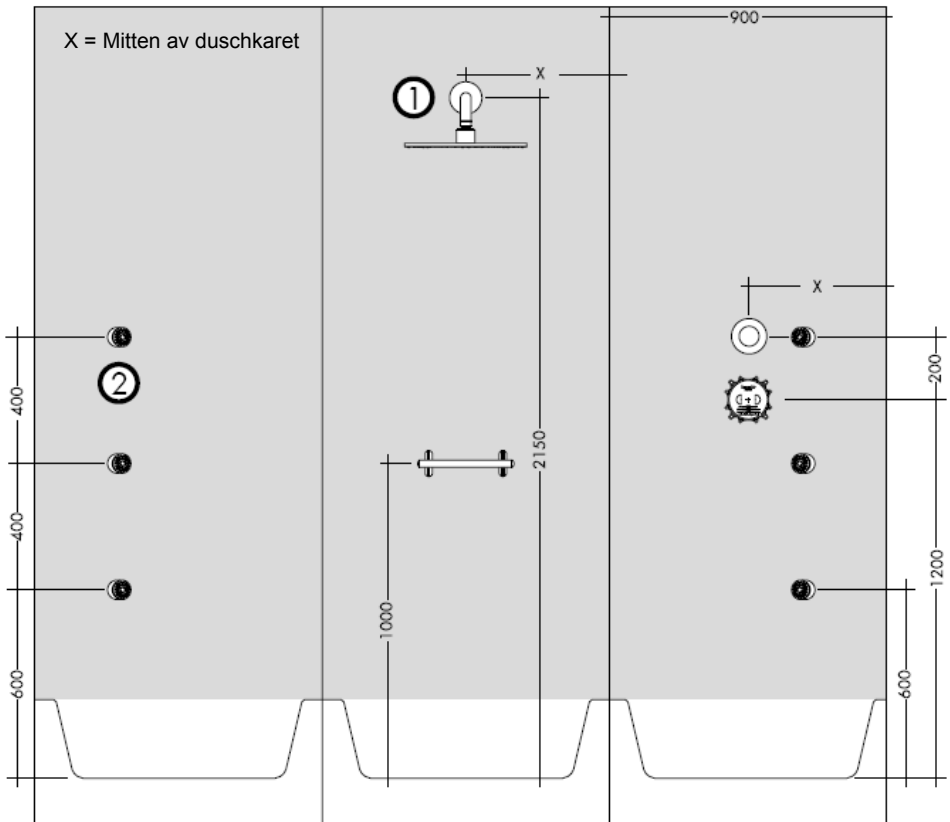

Väggförstärkning nödvändig för duscharmsmontering

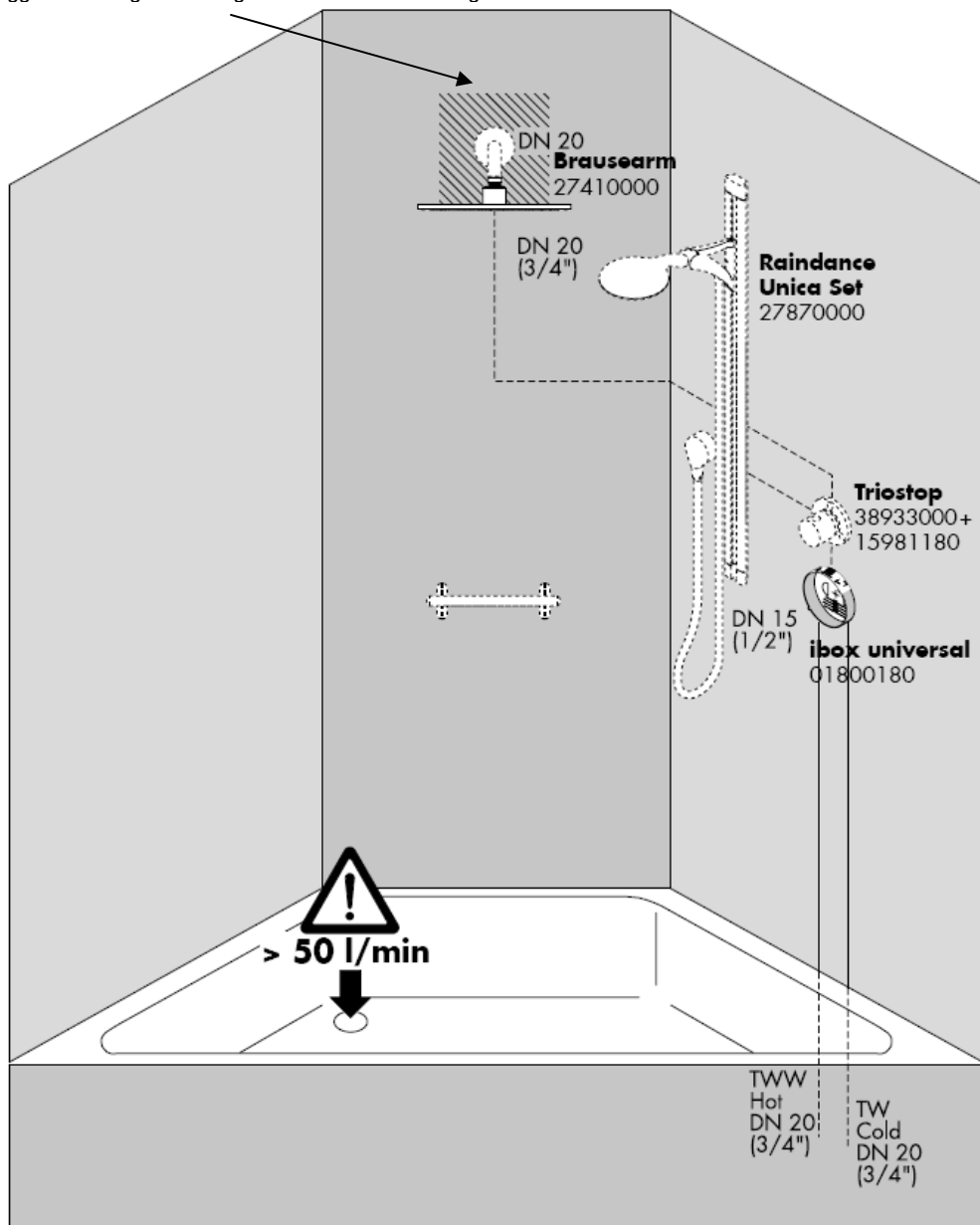

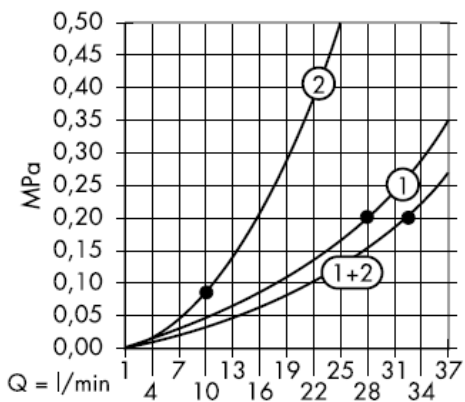

Från • garanteras funktionen.

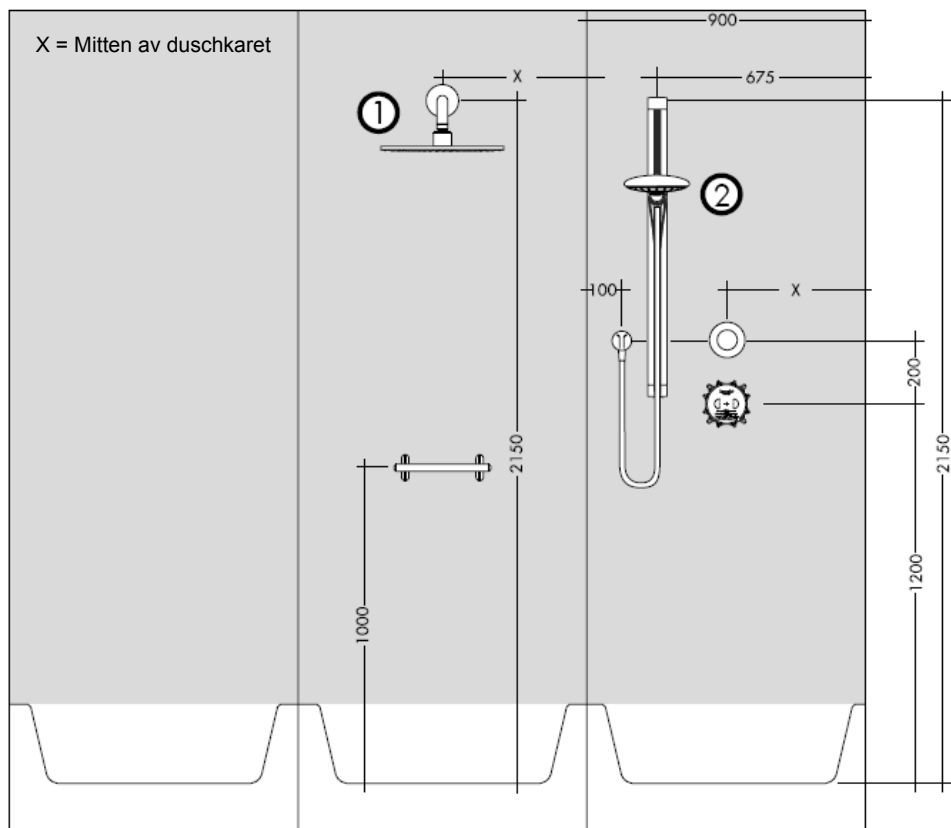

Väggförstärkning nödvändig för duscharmsmontering

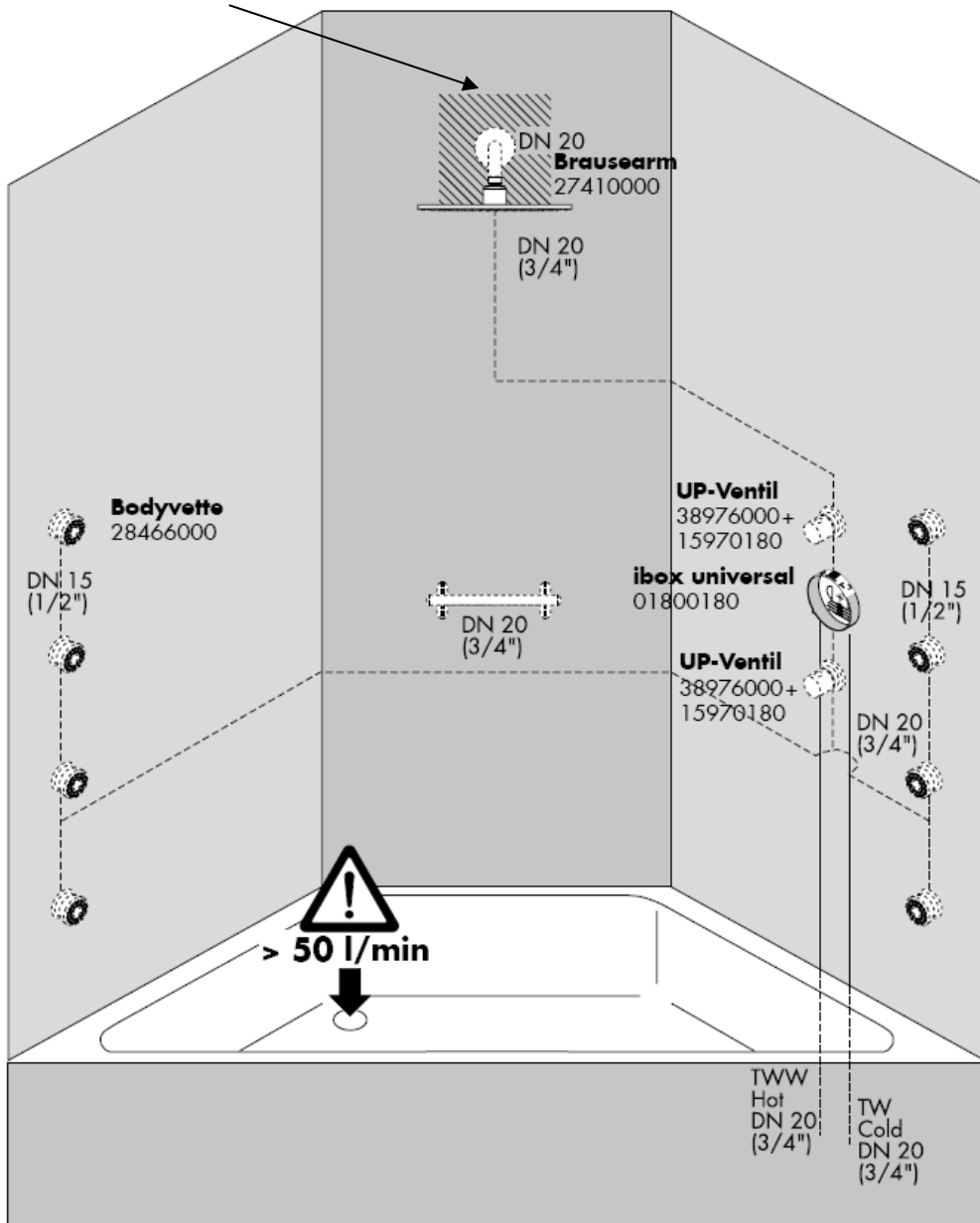

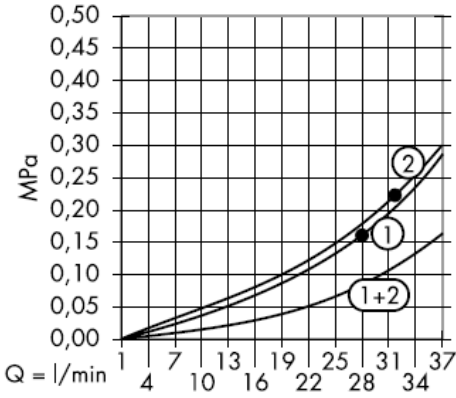

Från • garanteras funktionen.

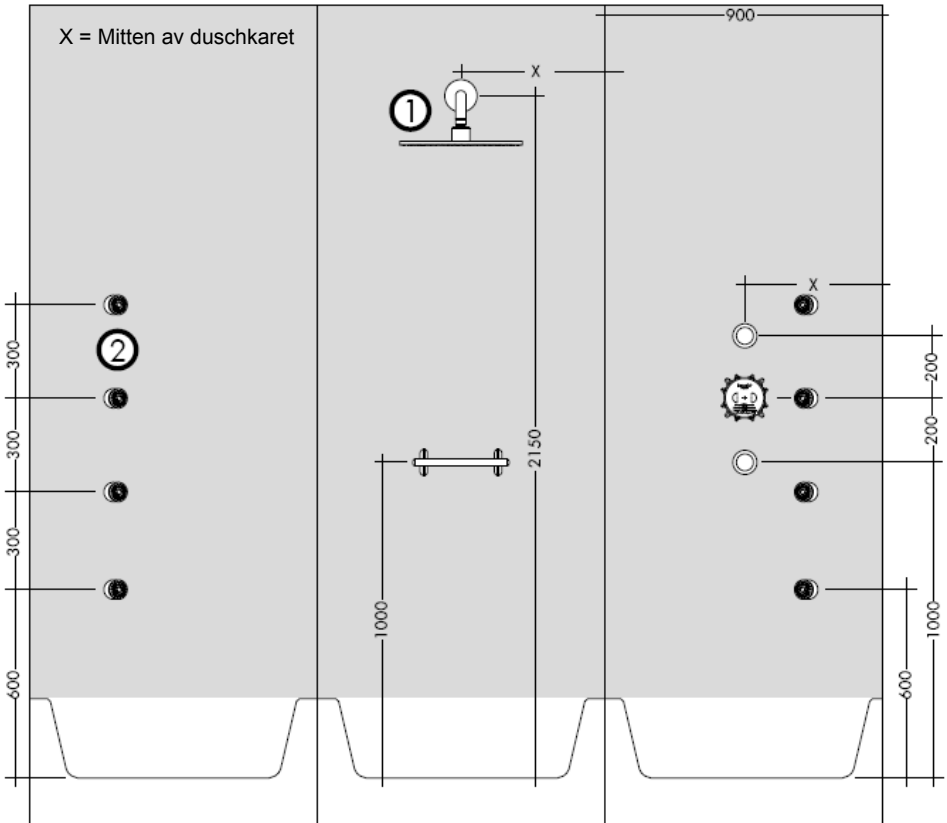

Väggförstärkning nödvändig för duscharmsermontering

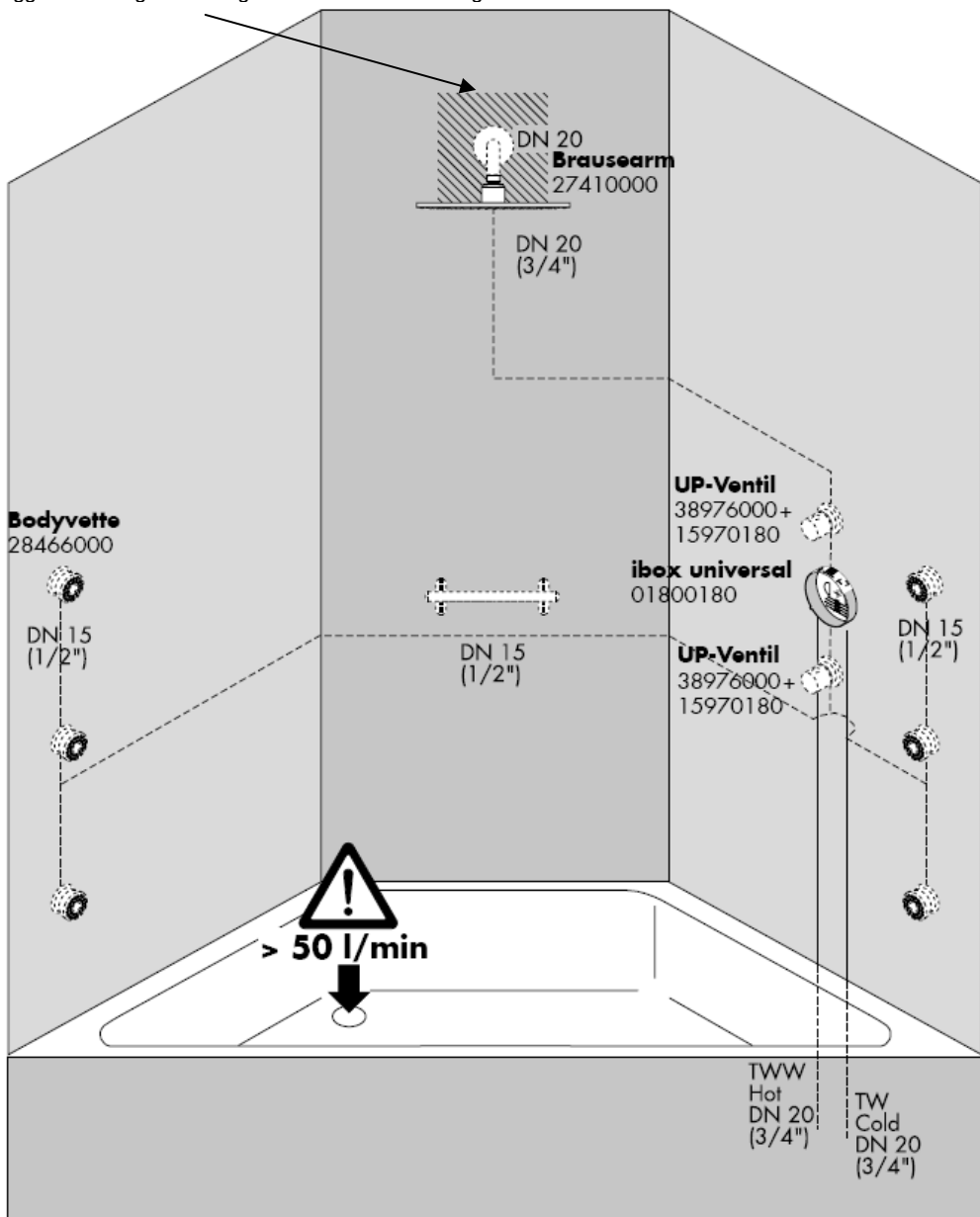

Väggförstärkning nödvändig för duscharmsmontering

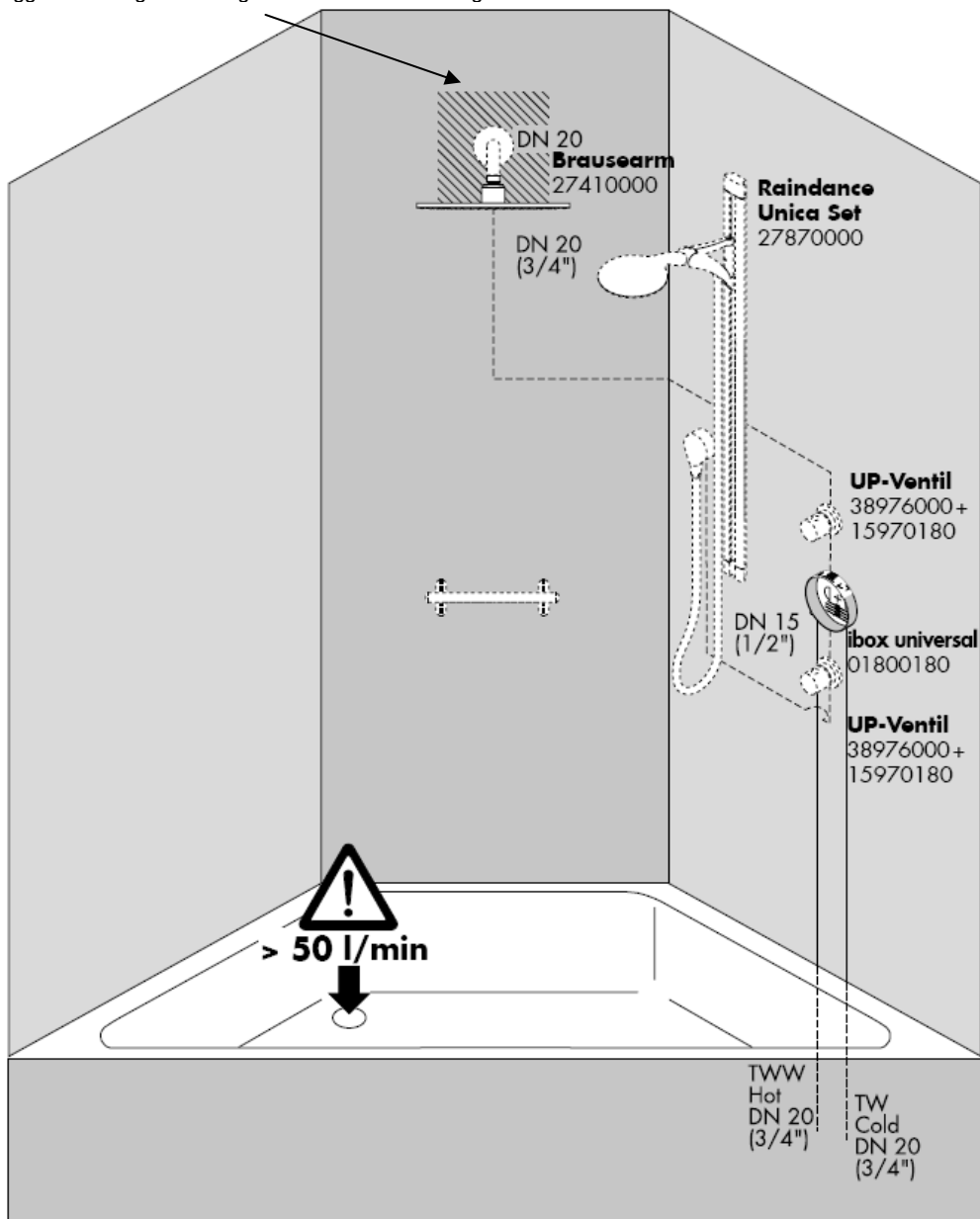

Väggförstärkning nödvändig för duscharmsmontering

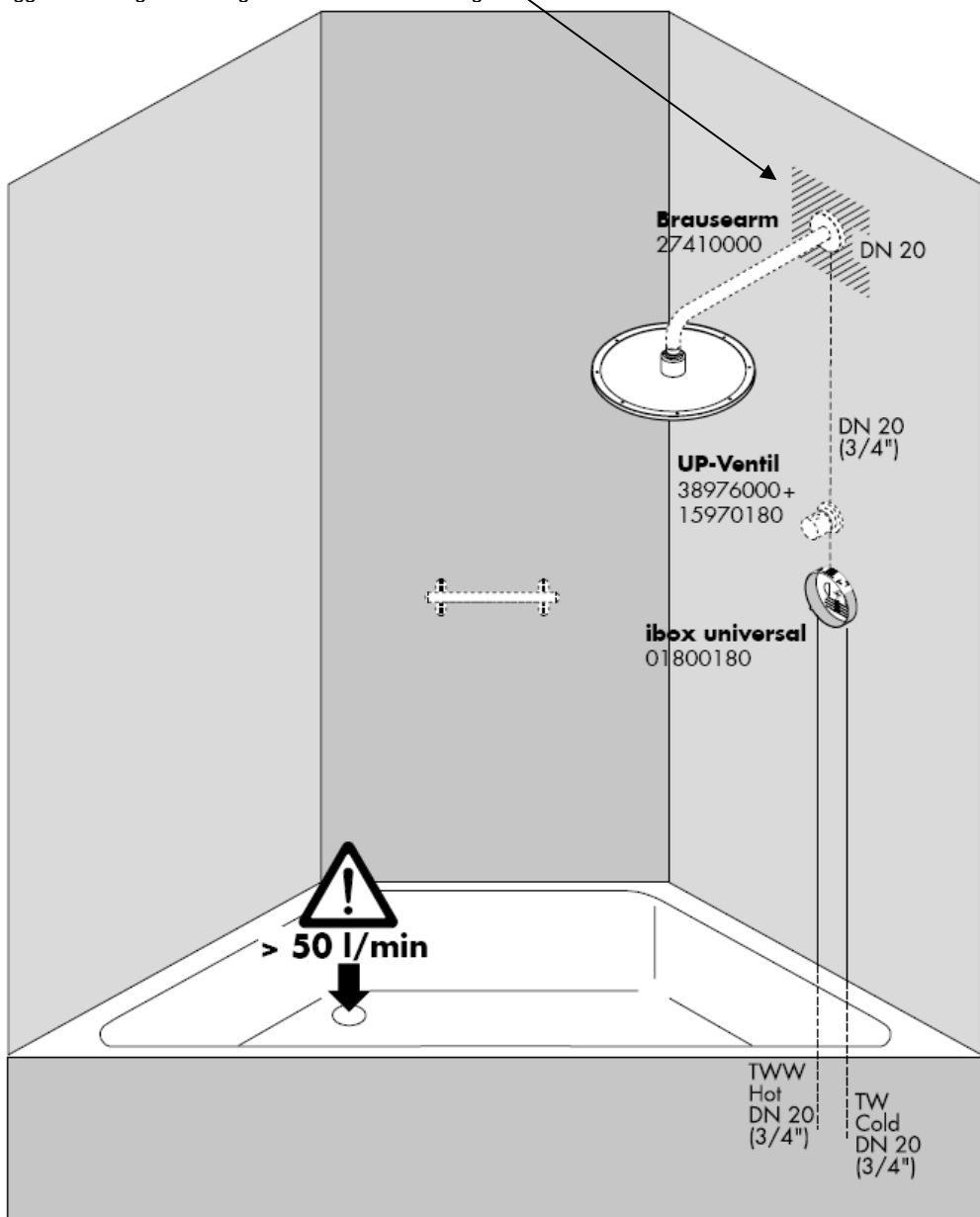

Från • garanteras funktionen.

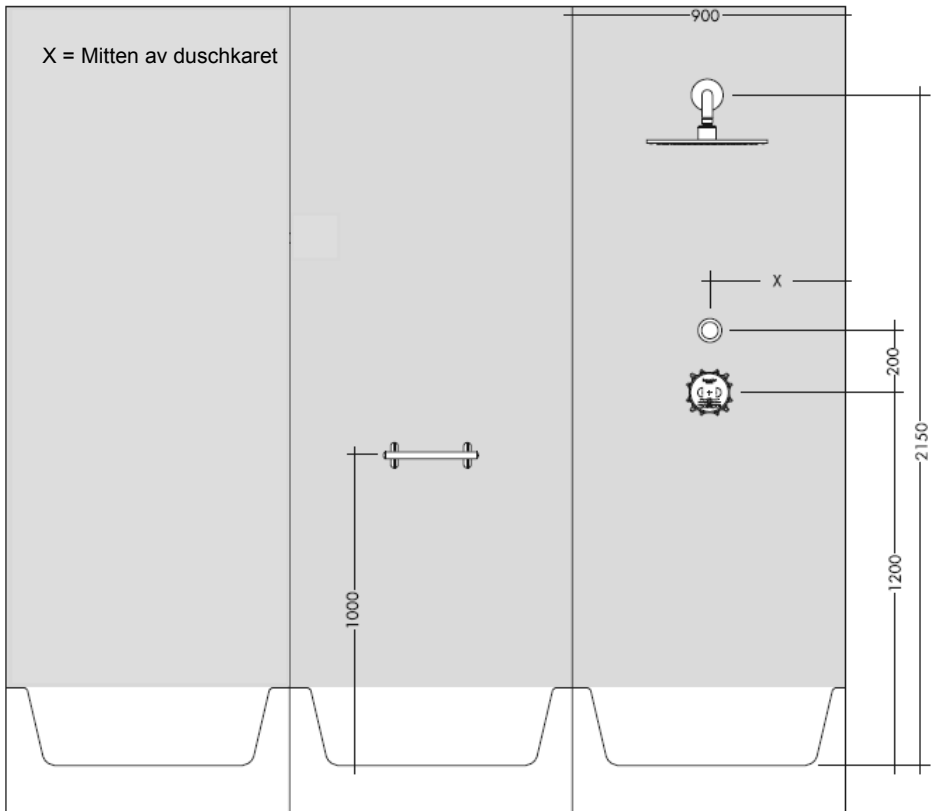
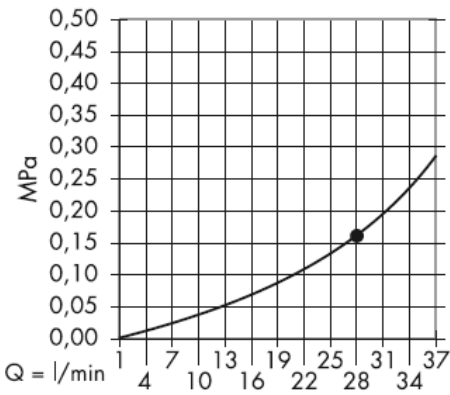

Väggförstärkning nödvändig för duscharmsmontering

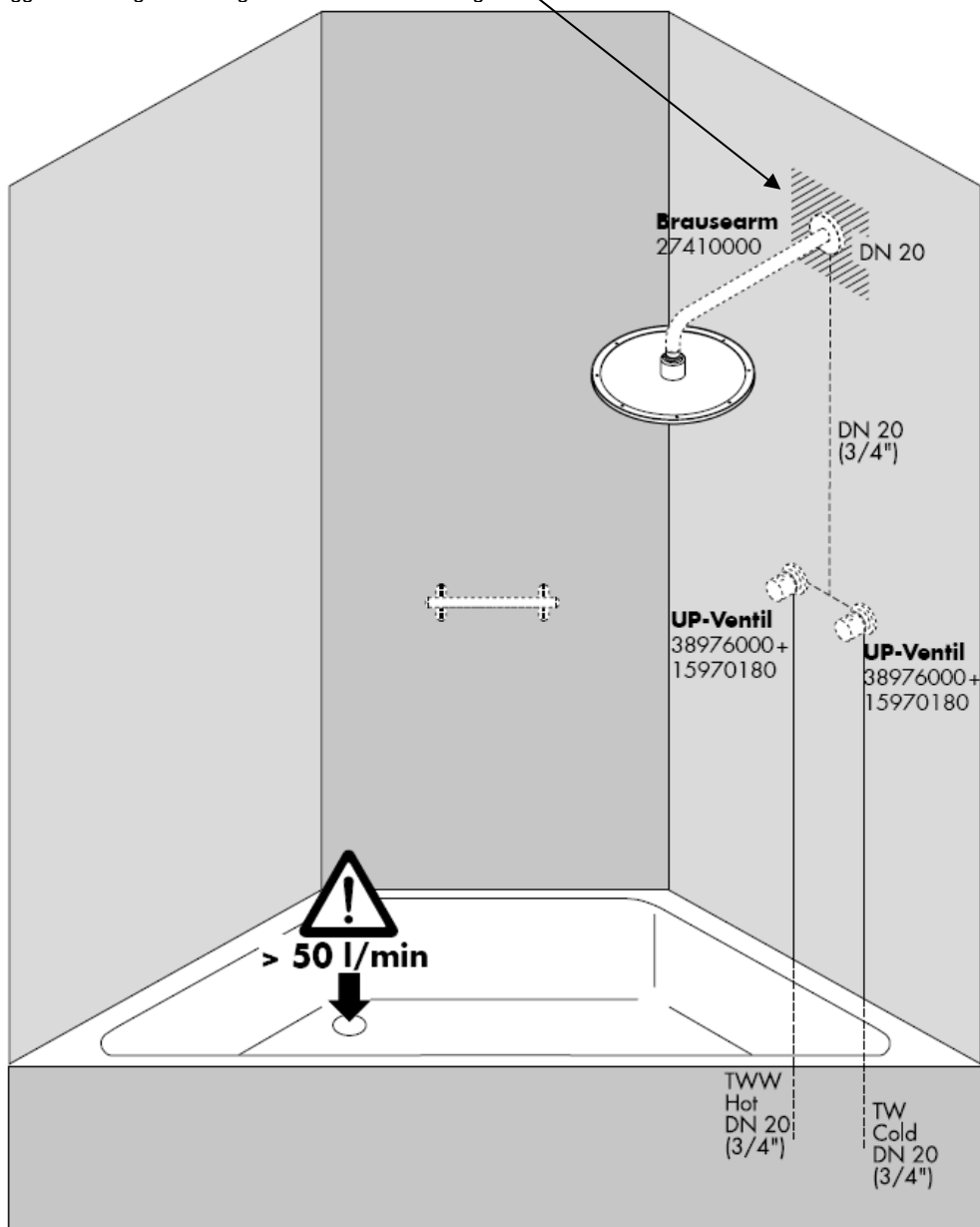

Från • garanteras funktionen.

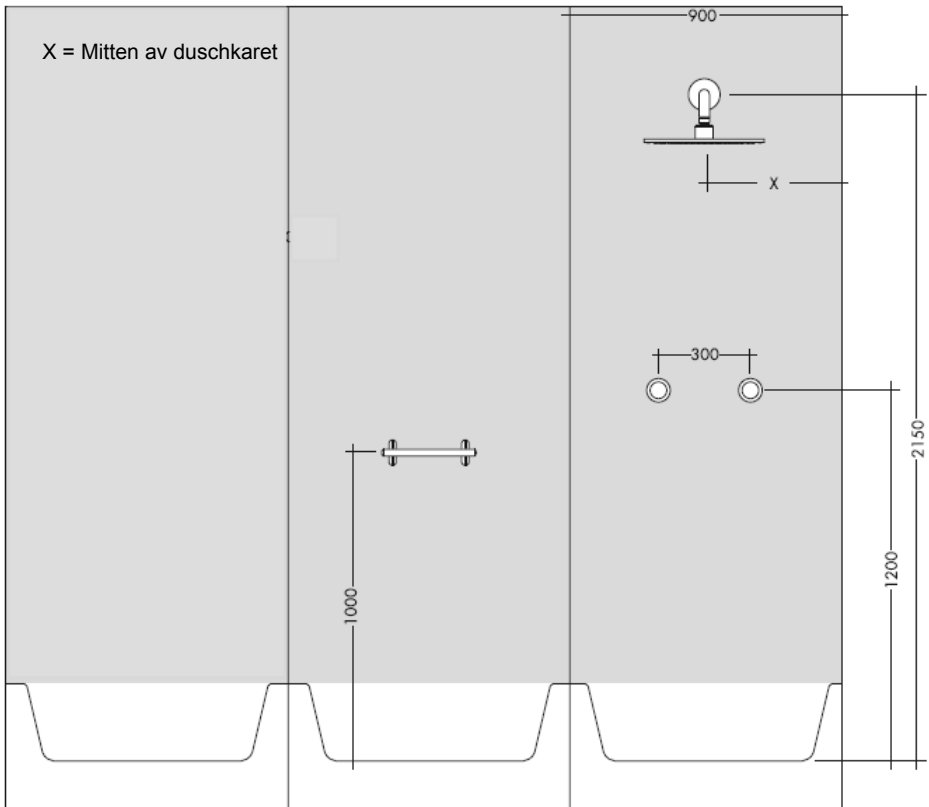
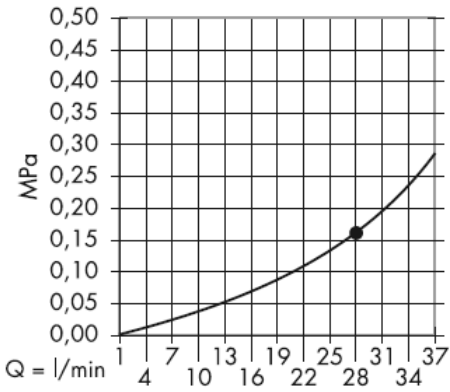

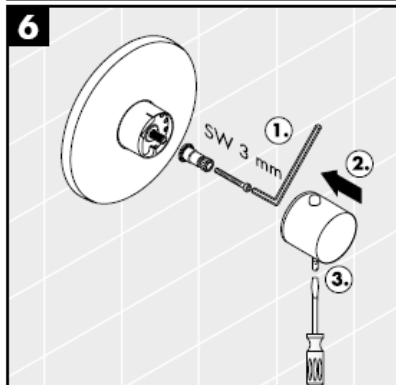
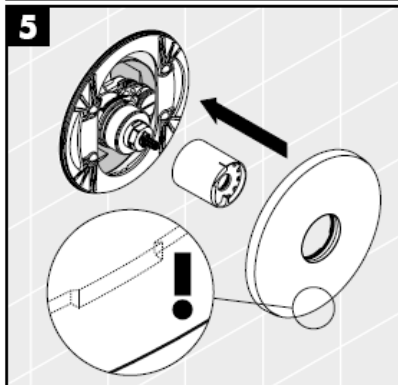
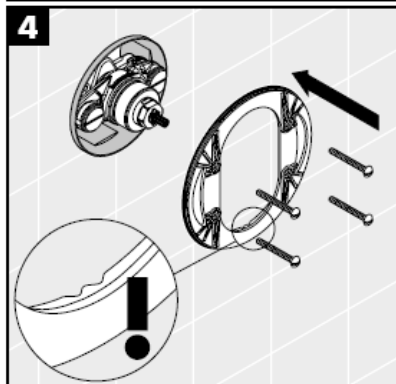
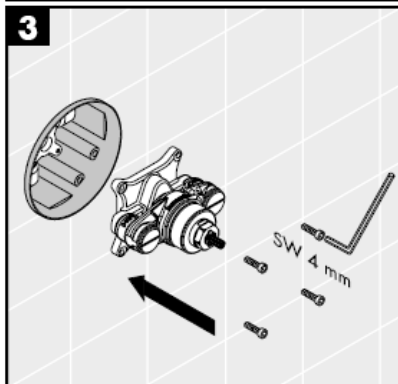
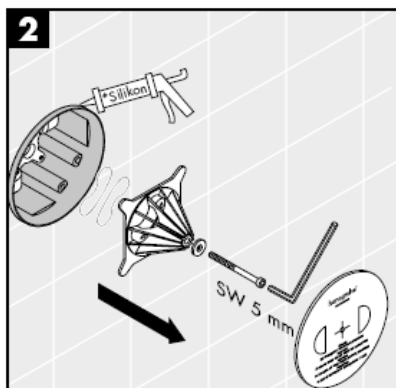
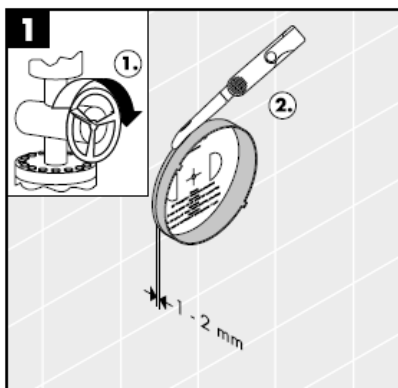

Silikon (fri från ättiksyra!)

Med hjälp av Safety Function kan du ställa in den önskade maximaltemperaturen till exempelvis 42 C och så förhindra skållningsrisk för barn.

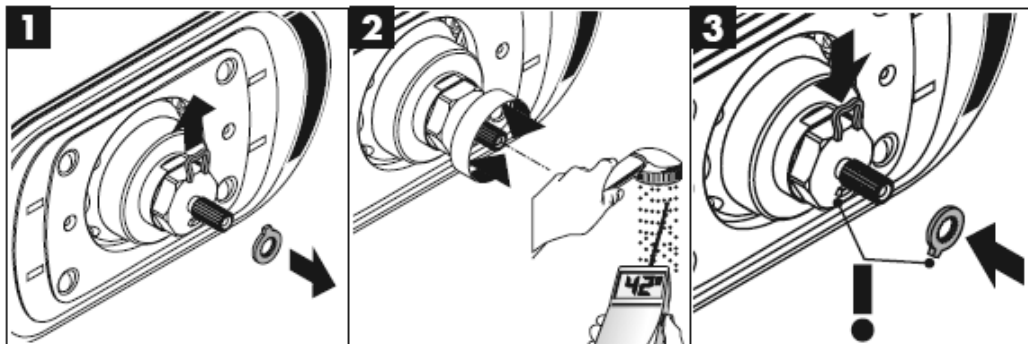

Inställning av maxtemperatur

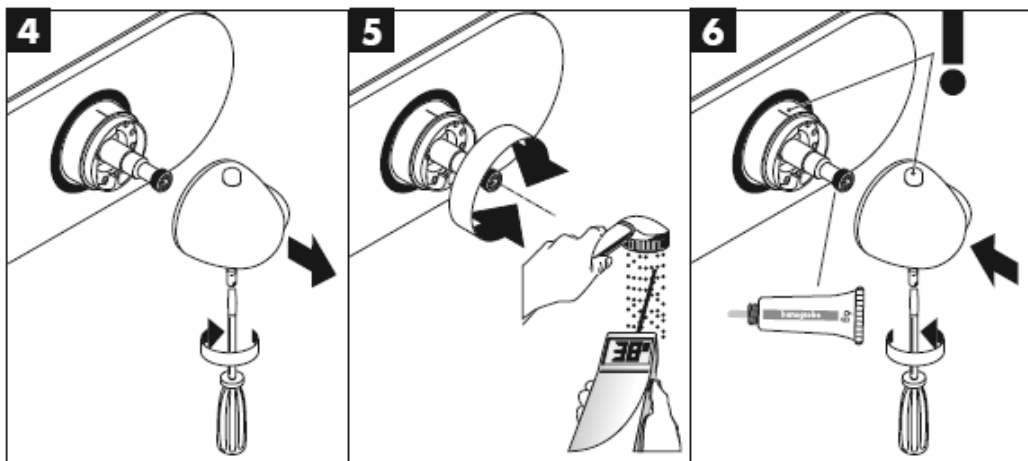



När duschen används väger den och duscharmen ca 10 kg tillsammans. Därför är det bara tillåtet att använda monteringsmaterial som passar till murverket! Medföljande skruvar och plugg är enbart avsedda för massivt murverk.

Endast fastsättningsmaterial som passar till murverk får användas! Medföljande skruvar och plugg ska endast användas i massivt murverk.

Tömningskapaciteten måste vara tillräcklig.

Optimal funktion garanteras bara tillsammans med Hansgrohe High Flow termostater.

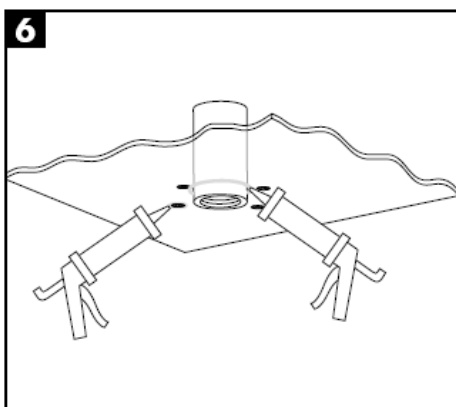
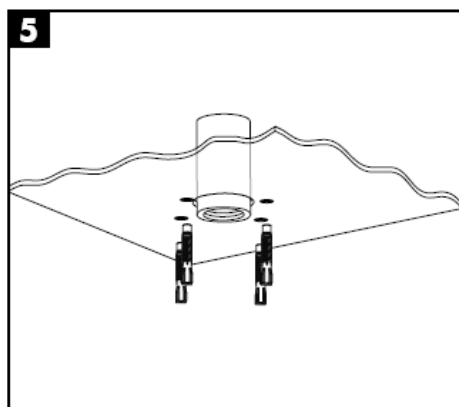
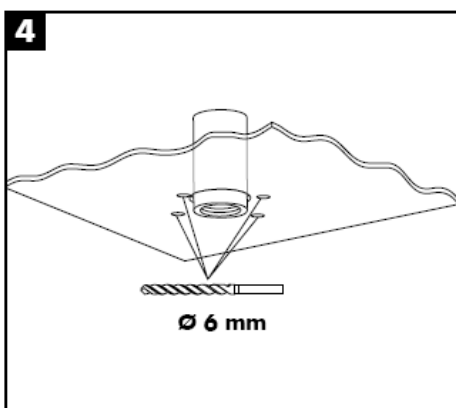
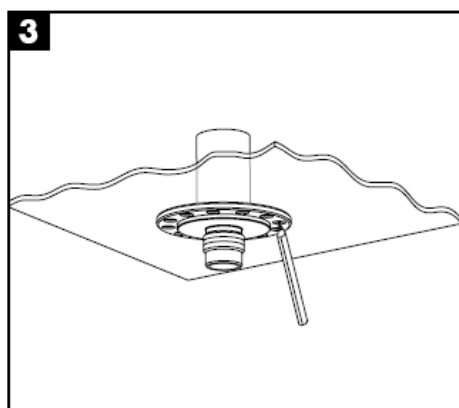
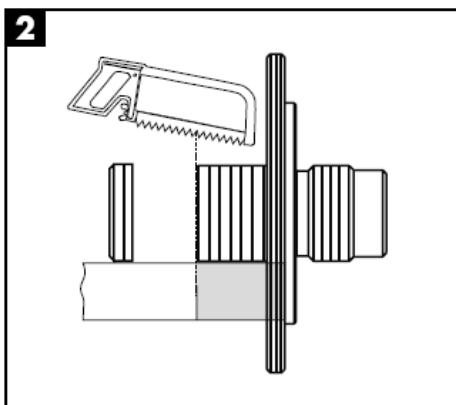
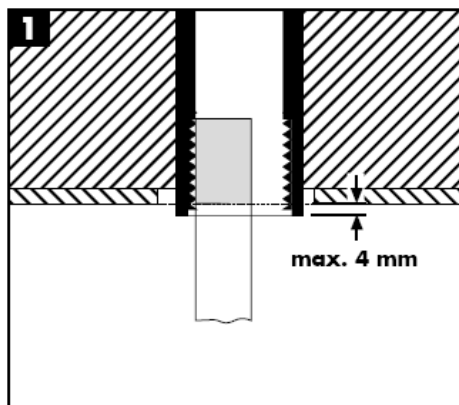

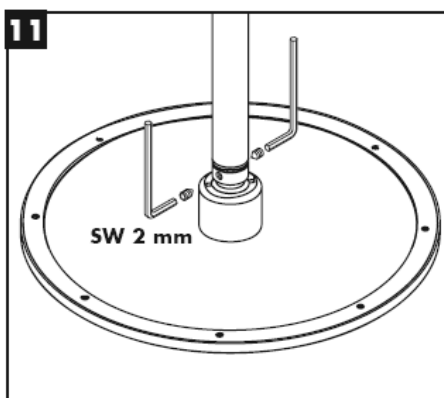
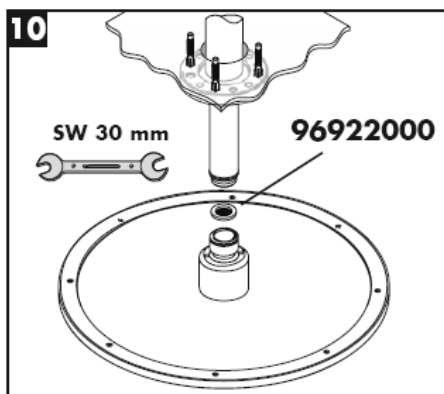
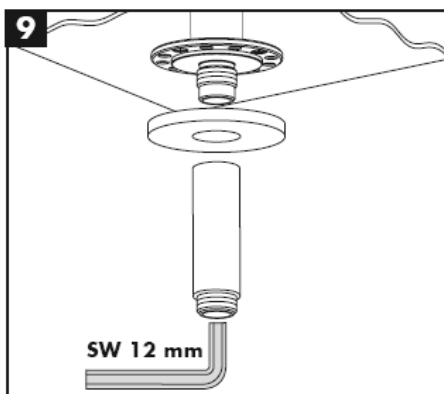
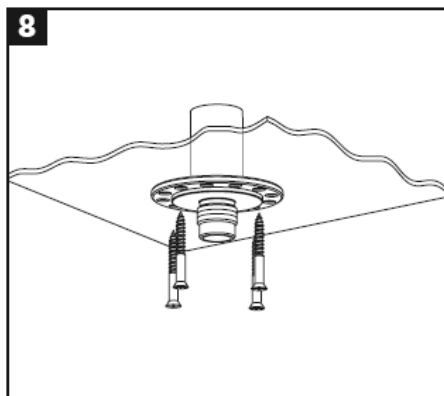
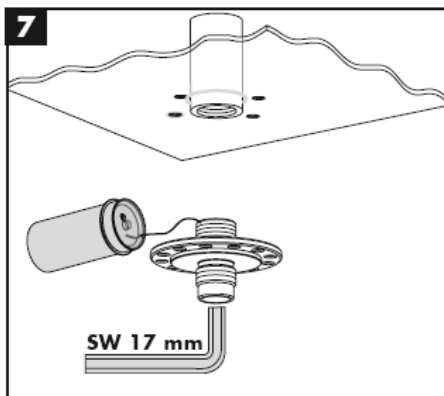

Silpackningen som följer med duschen måste monteras för att undvika att smuts från ledningsnätet tränger in. Smuts som spolas in kan påverka funktionerna och/eller leda till skador på funktionsdelar i duschen. Hansgrohe fränsäger sig allt ansvar för skador som kan härledas till detta.

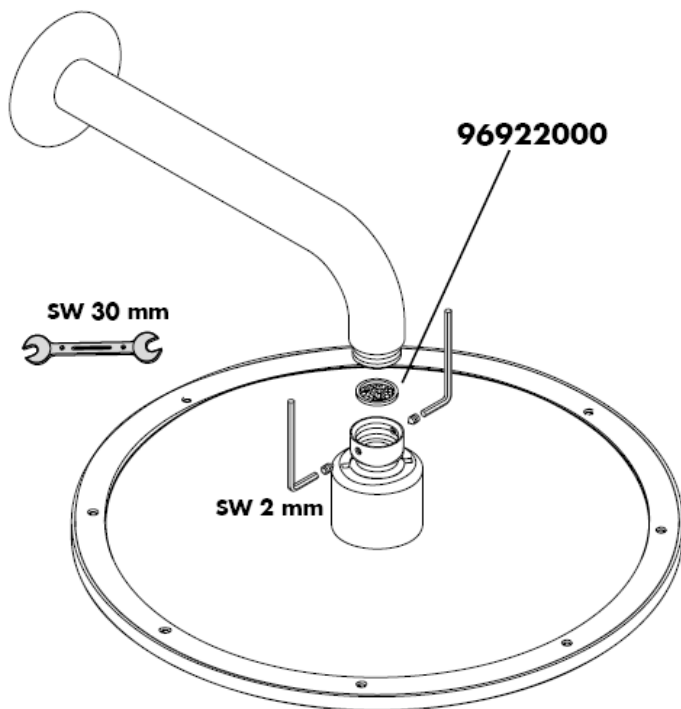

Montering

OBS! Blandaren måste installeras, genomspolas och testas enligt gällande föreskrifter.

Inställning av maxtemperatur

En korrigerig krävs när temperaturen vid utflödet avviker från den temperatur som är inställd på termostaten. Tänk då på följande: Vrid på skalgreppet tills 38 °C vatten kommer ut. Släpp greppskruven, drag tillbaka greppet och vrid till 38 °C. Sätt greppet på plats och drag fast greppskruven (se sidan 22).

Temperaturinställning

En spärr är inbyggd för att begränsa temperaturen till 38 °C. Önskas högre temperatur så kan 38 °C spärren kringgås om man tycker in säkerhetsknappen.

Safety Function

Med hjälp av Safety Function kan du ställa in den önskade maximaltemperaturen till exempelvis 42 °C och så förhindra skällningsrisk för barn. se sidan 21.

Tekniska data

Driftstryck: max. 1 MPa
 Rek. driftstryck: 0,1 – 0,5 MPa
 Tryck vid provtryckning: 1,6 MPa
 (1 MPa = 10 bar = 147 PSI)
 Varmvattentemperatur: max. 80 °C
 Rek. varmvattentemp.: 65 °C
 Genomströmningmängd: ca. 58 l/min 0,3 MPa

Skötsel

Termostater kräver ingen speciell service. Backventilens funktion måste kontrolleras regelbundet enligt nationella eller regionala bestämmelser (DIN 1988 en gång per år) i enlighet med DIN EN 1717. Kontrollera även smutsfiltren som sitter på termosensorn (6.1) vid detta tillfälle. När termosensorn (6) har monterats måste uttemperaturen kontrolleras, enligt beskrivning under avsnitt "Inställning". Kontrollera först om varmvattenförsörjningen är inkopplad och att max. varmvattentemperatur är uppnådd vid tappstället.

För att garantera att termostaten ej kalkar igen, ska den regelbundet, en gång per vecka, konditioneras. Det sker genom att man några gånger snabbt slår om temperaturen från hett till kallt och tillbaka.

Reservdelar se sidan 3

1	Termostatgrepp	38391000
2	Rosett	96452000
3	Hylsa	97439000
4	Stödskravar	96454000
5	Stödrossett	96447000
6	Termostatelement	96633000
7	Filter	97367000
8	Backventil	96655000
9	Förlängning 25 mm	13595000
10	Förlängning 25 mm	13596000

Svenska

Störning	Orsak	Åtgärd
För lite vatten	-Vattentrycket är för lågt -Smutsfilter i styrenheten igensatt -Silfiltret i duschen smutsigt	-Kontrollera ledningstryck -Rengör smutsfilter -Rengör silfiltret mellan slangen och termostaten
Korsflöde – varmt vatten pressas vid avstängd ermostat in i kallvatten- inloppet, och vice versa	-Backventil är igensmutsad eller otät	-Byt backventil
Den faktiska vatten-temperaturen stämmer Inte överens med den Inställda	-Termostaten ställdes inte in -Varmvattentemperaturen är för låg	-Justera termostaten -Höj varmvattentemperaturen till mellan 42 C och 65 C
Temperaturen kan ej ställas in	-Temperaturinställning smutsig eller täckt av kalk -Montera funktionsblocket med 180 förskjutning	-Grundkonstruktionen anslöts på fel sätt vid nyinstallation (ska vara: kallt höger, varmt vänster) eller monterades med 180 förskjutning -Tryckknappen till säkerhetsspärren har ingen funktion
Fjäder defekt	-Rengör fjäder eller tryckknapp och smörj in något, eller byt ut om detta behövs -Tryckknapp förkalkad	-Rengör fjäder eller tryckknapp och smörj in något, eller byt ut om detta behövs -Rengör fjäder eller tryckknapp och smörj in något, eller byt ut om detta behövs

Testsigill

	P-IX	DVGW	SVGW	WRSA	KIWA	ACS	NF
27070000						X	
27418XXX							
28420000						X	
28435XXX						X	

Rengöring

Enkelt att göra rent: det är lätt att ta bort kalk från nopporna.

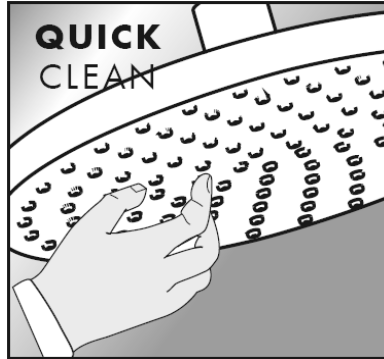

Skötselanvisningar

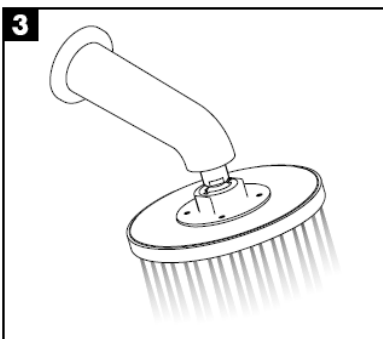
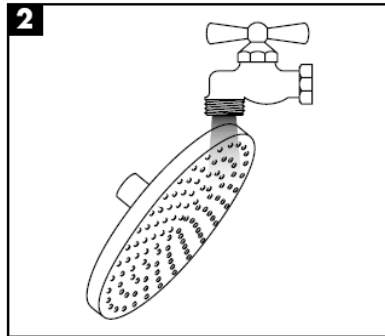
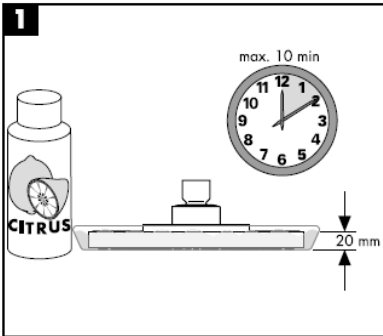

hansgrohe

Montavimo instrukcijos



27418XXX

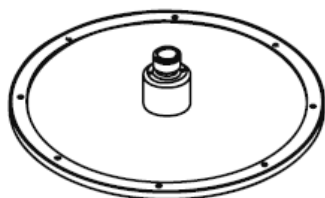

Raindance Royale AIR
28420000

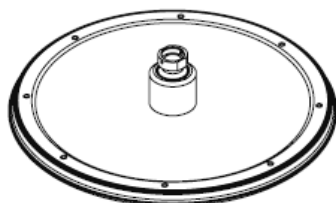

Raindance Royale Classic AIR
28435XXX

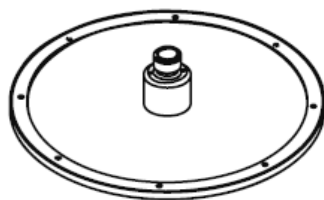

**Raindance Royale
High Flow Set**
27070000

hansgrohe

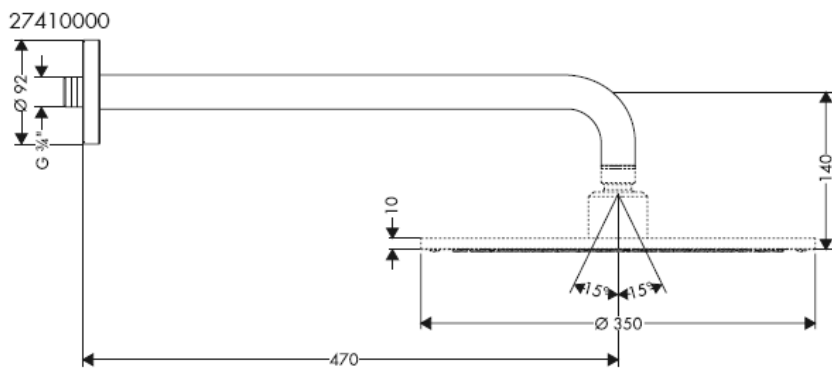
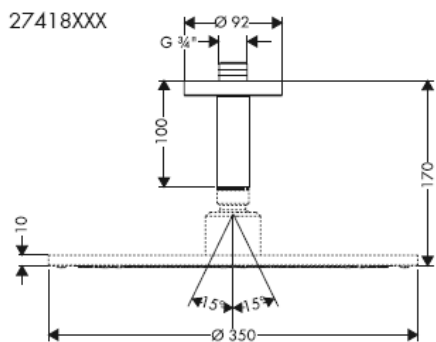
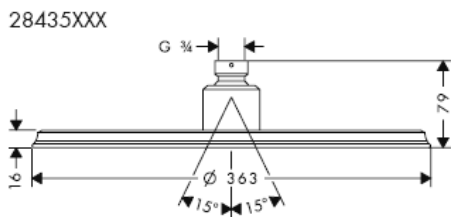
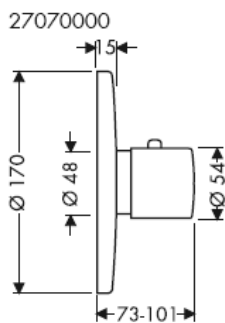
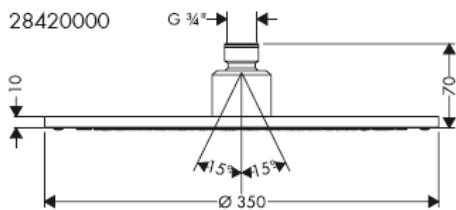

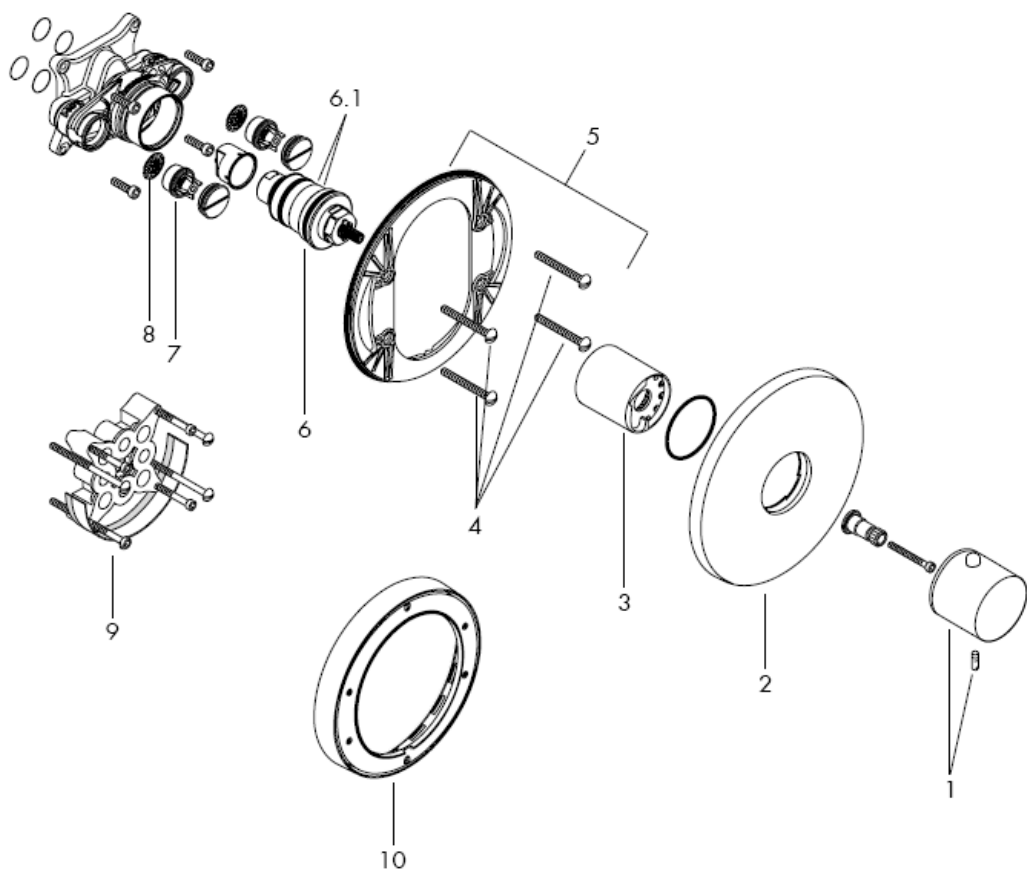

Jei įmanoma, kabindami stovą derinkite prie plytelių.

Dušo vamzdžiui tvirtinti būtinas tvirtinamasis sienos elementas

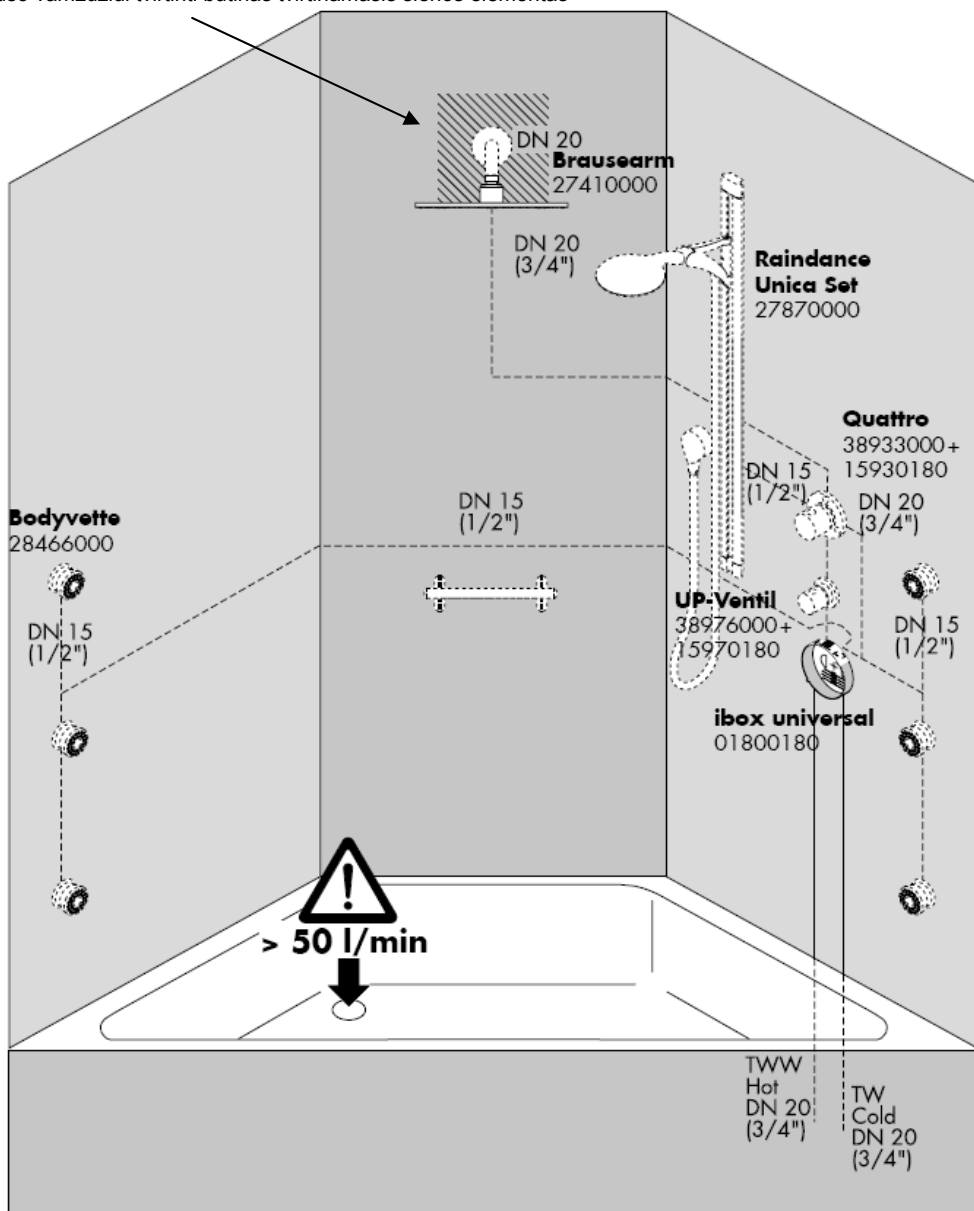

Nuo • funkcionavimas garantuotas

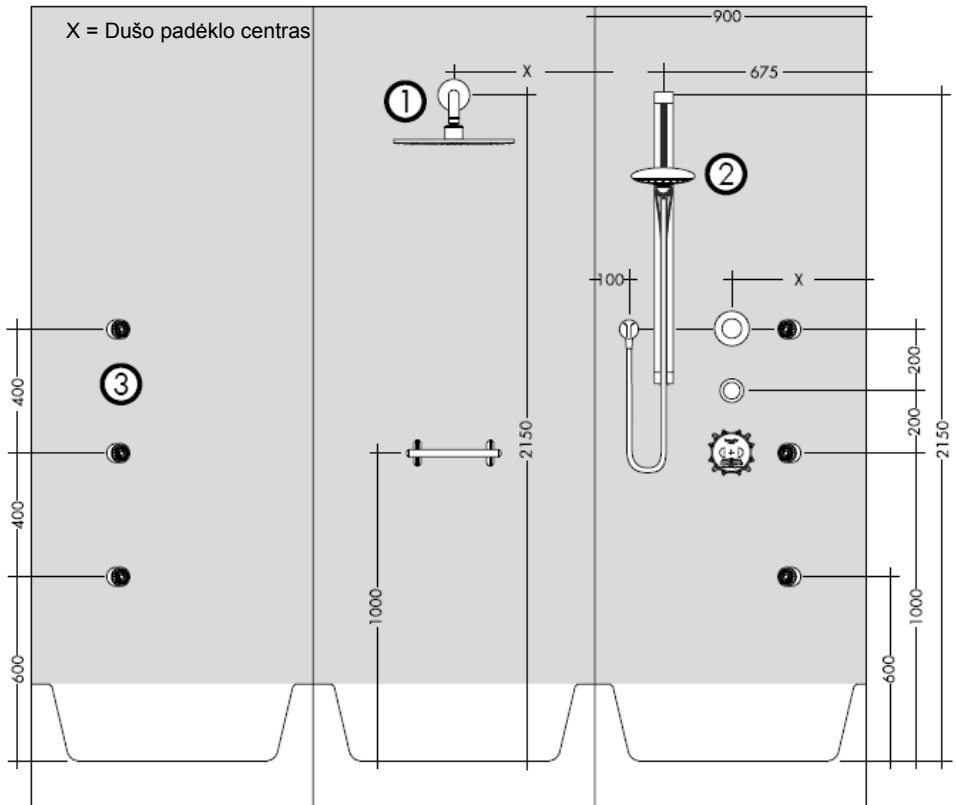
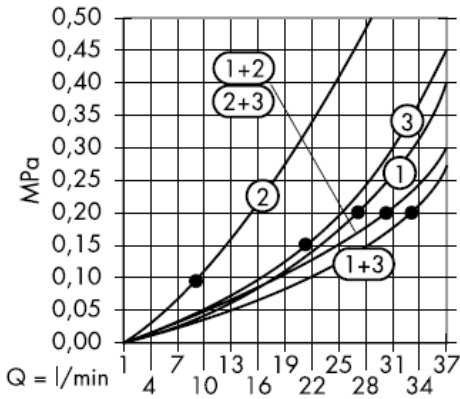

Dušo vārdzīmi tvirtinti būtinās tvirtinamās sienas elementas

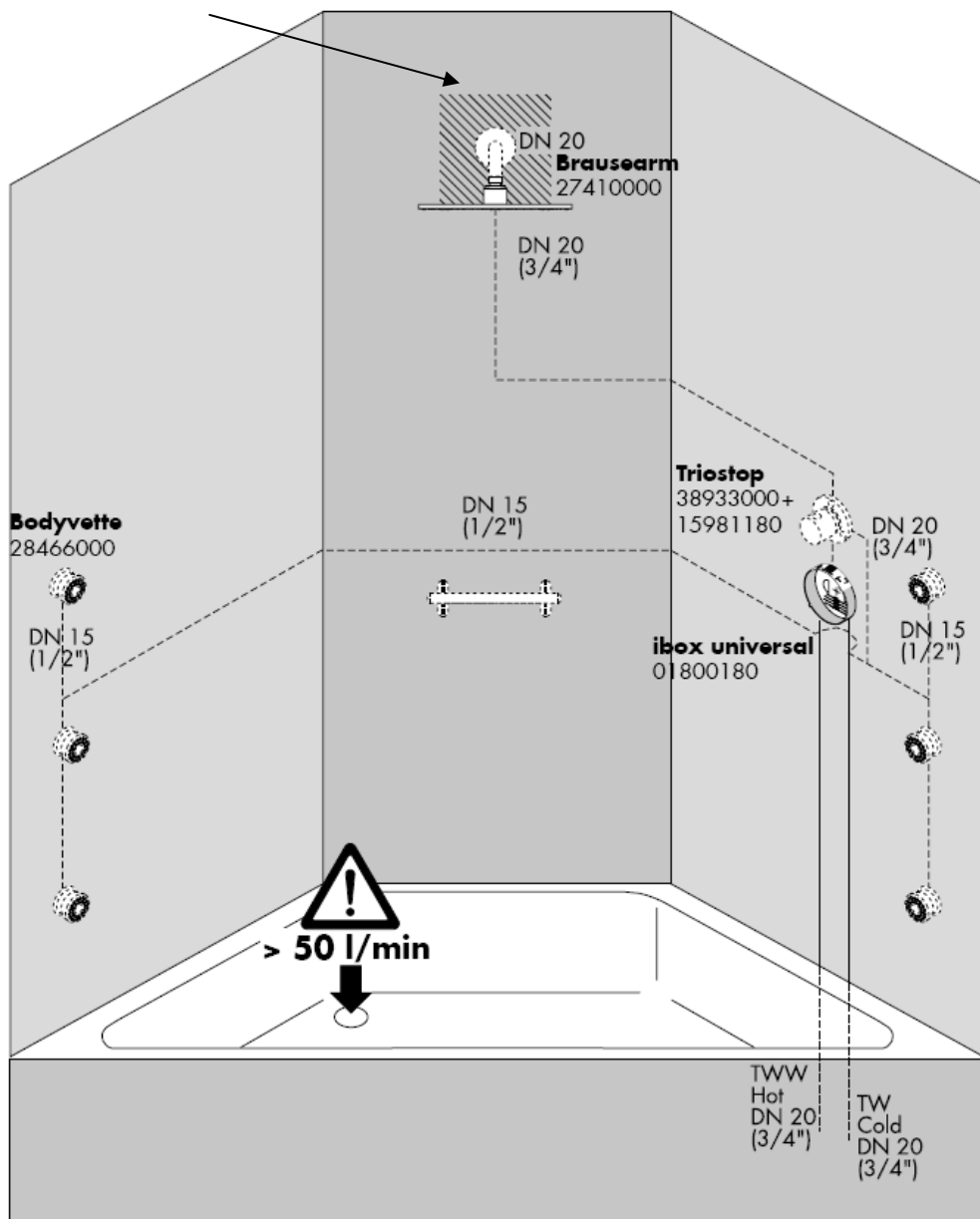

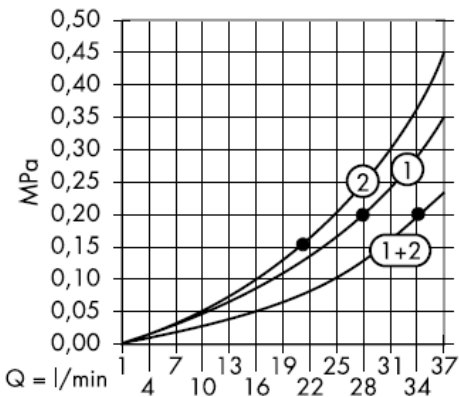

Nuo • funkcionavimas garantuotas

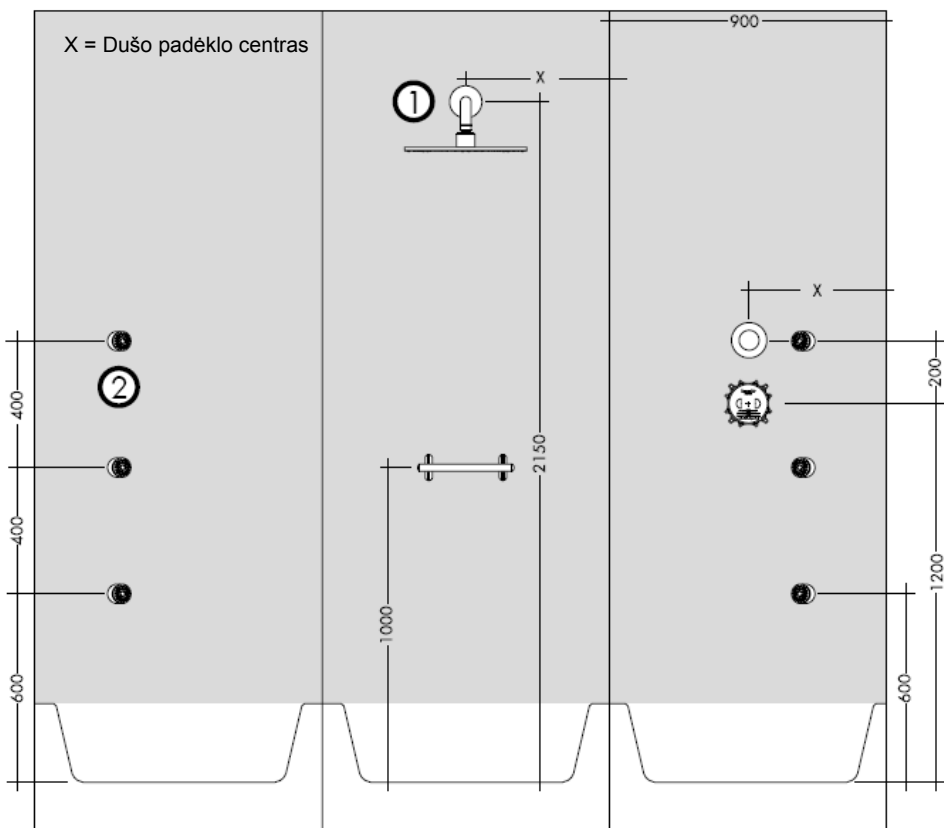

Dušo vamzdžiui tvirtinti būtinas tvirtinamasis sienos elementas

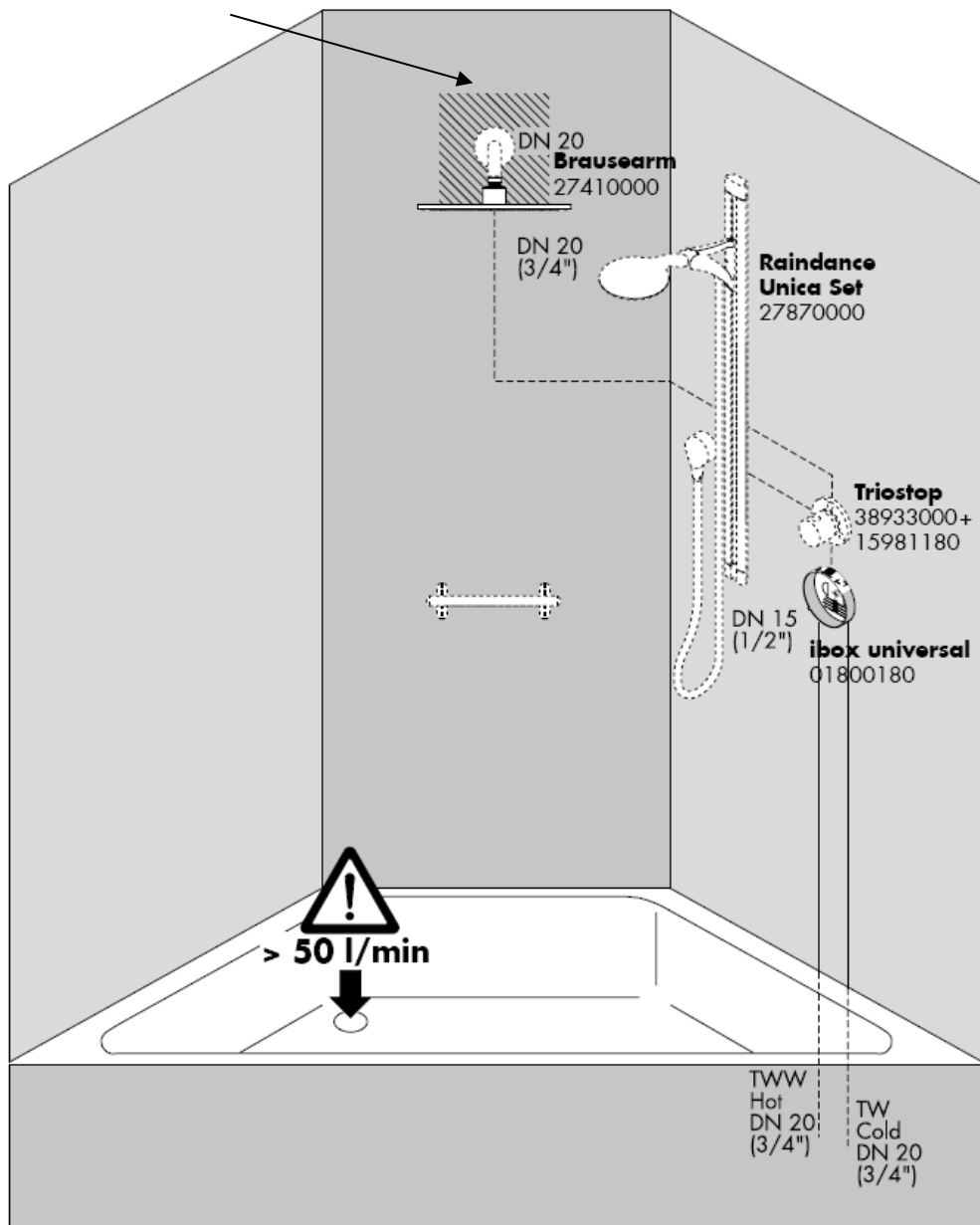

Dušo vamzdžiui tvirtinti būtinas tvirtinamasis sienos elementas

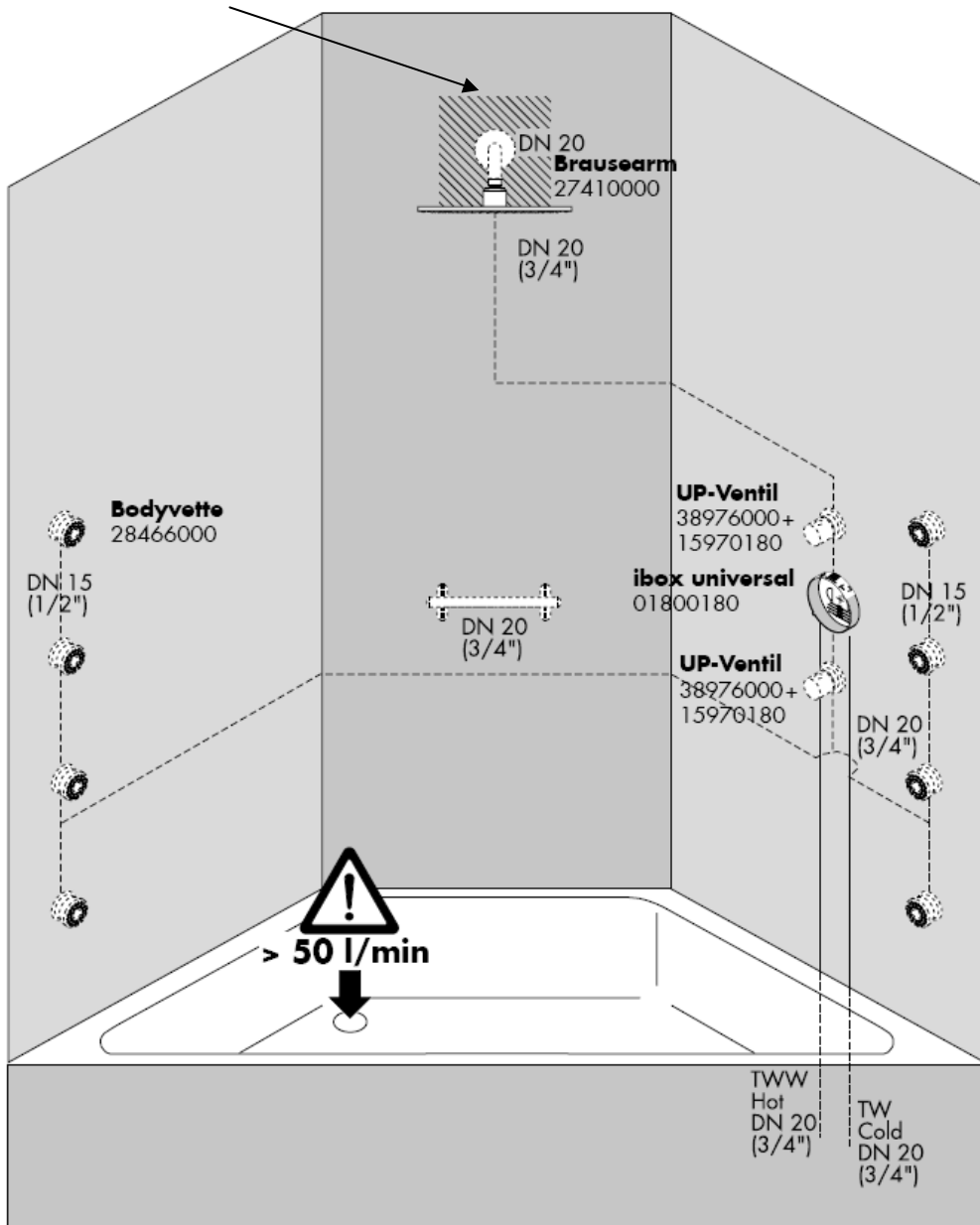

Nuo • funkcionavimas garantuotas

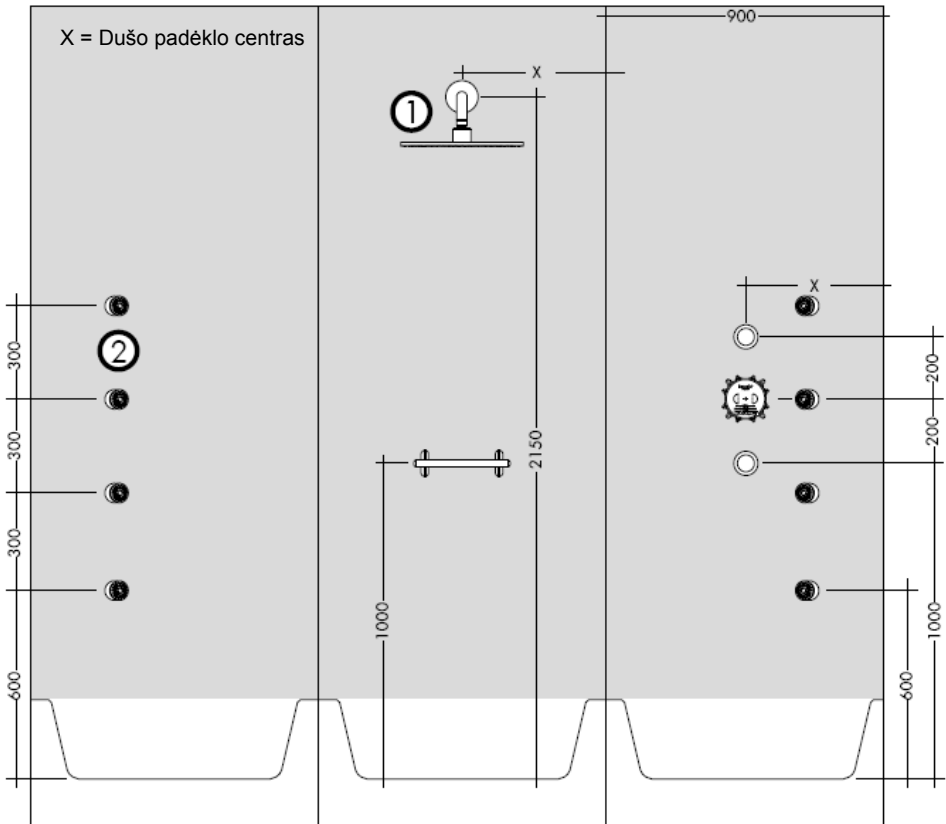
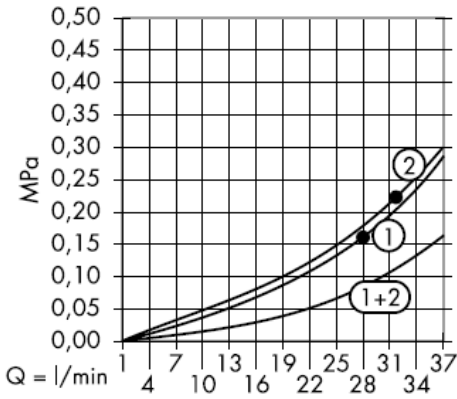

Dušo vārdzīui tvirtinti būtinās tvirtinamās sienas elementas

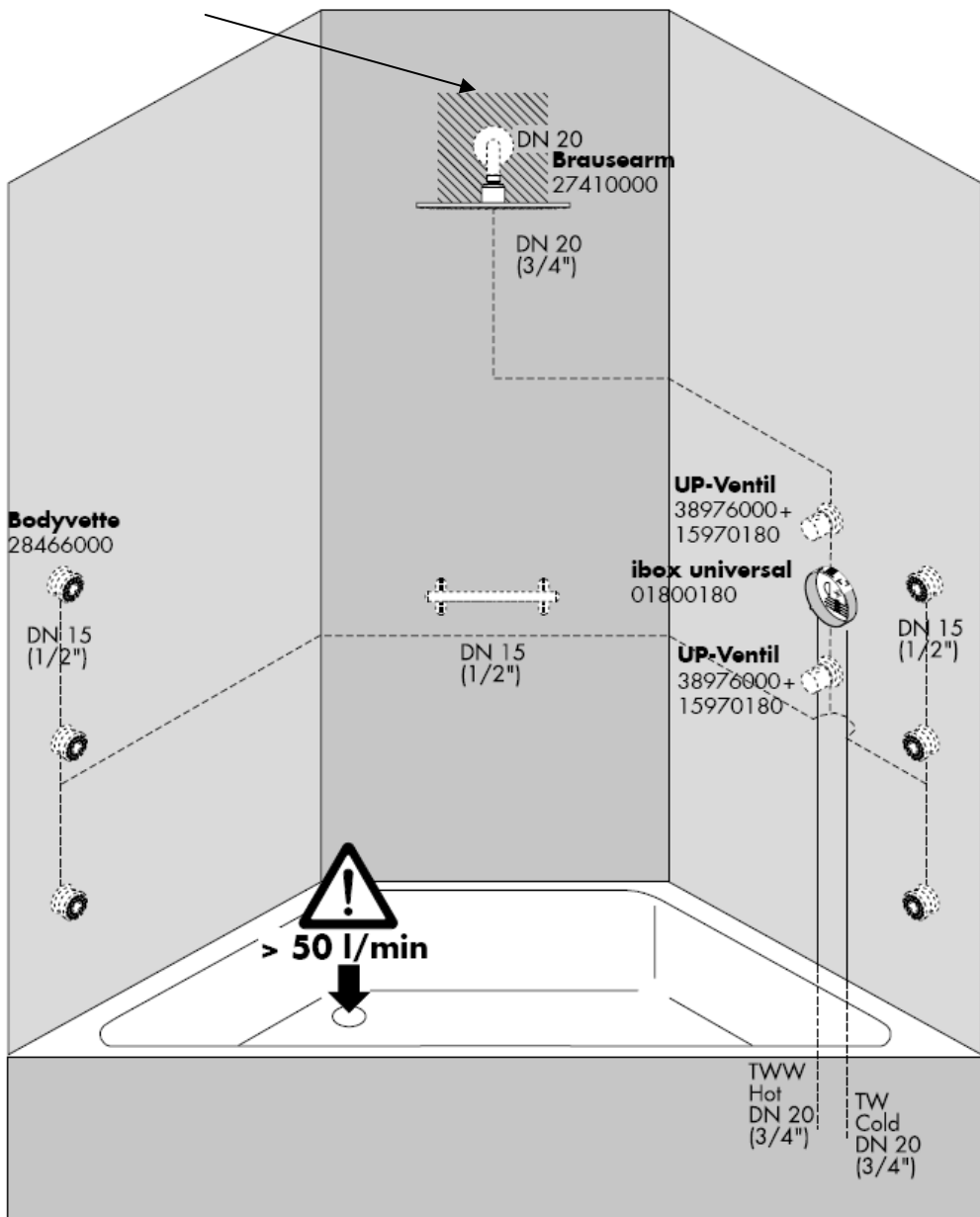

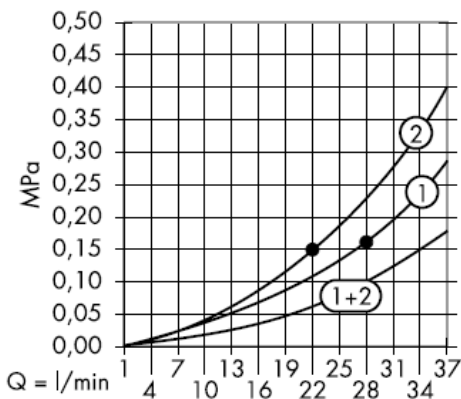

Nuo • funkcionavimas garantuotas

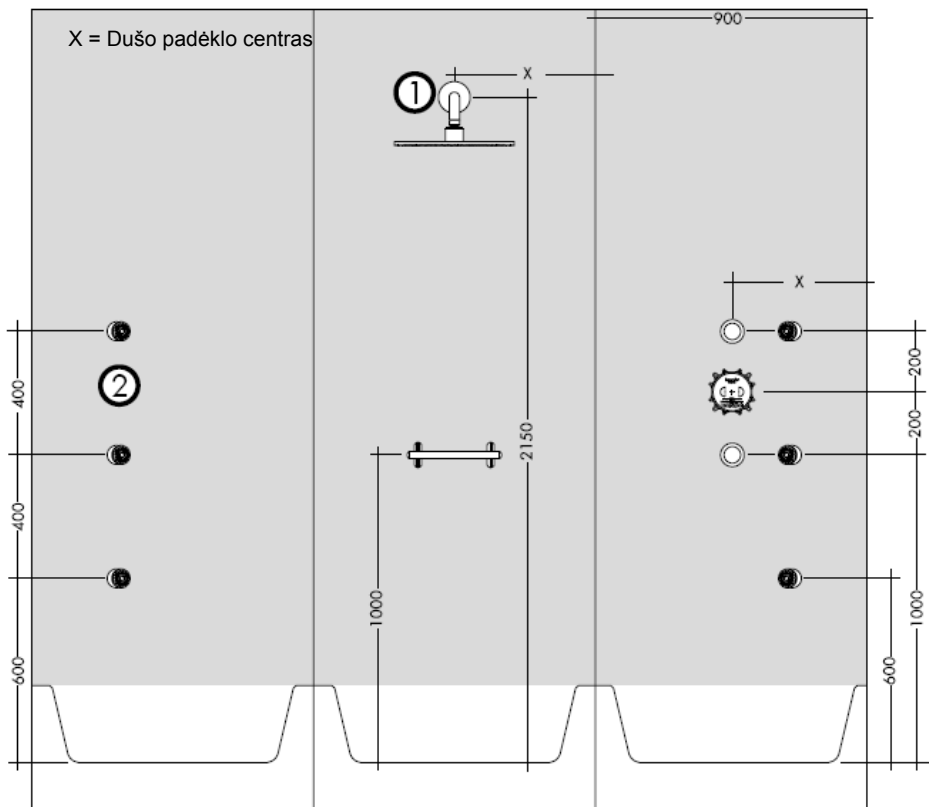

Dušo vamzdžiui tvirtinti būtinas tvirtinamasis sienos elementas

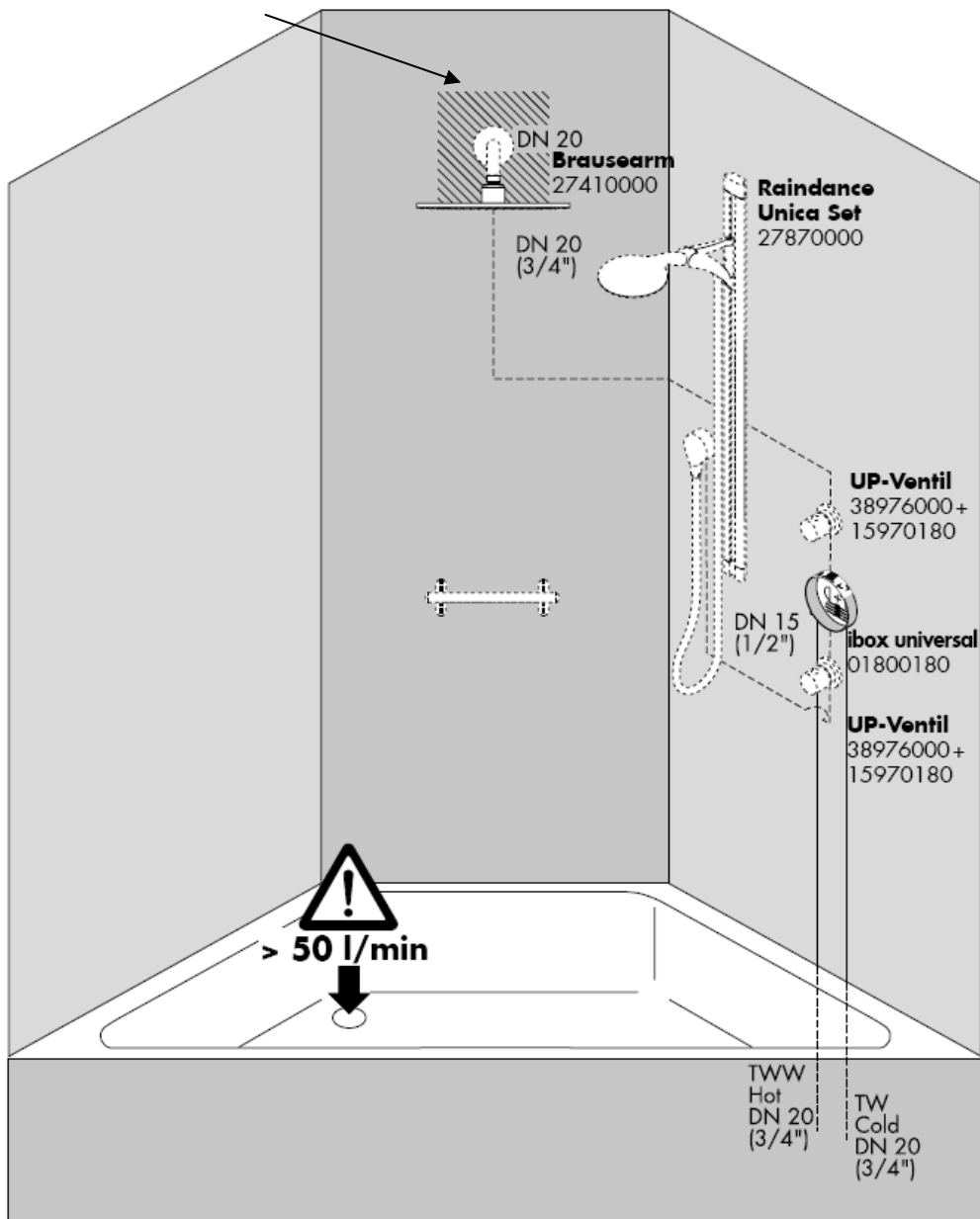

Dušo vamzdžiui tvirtinti būtinas tvirtinamasis sienos elementas

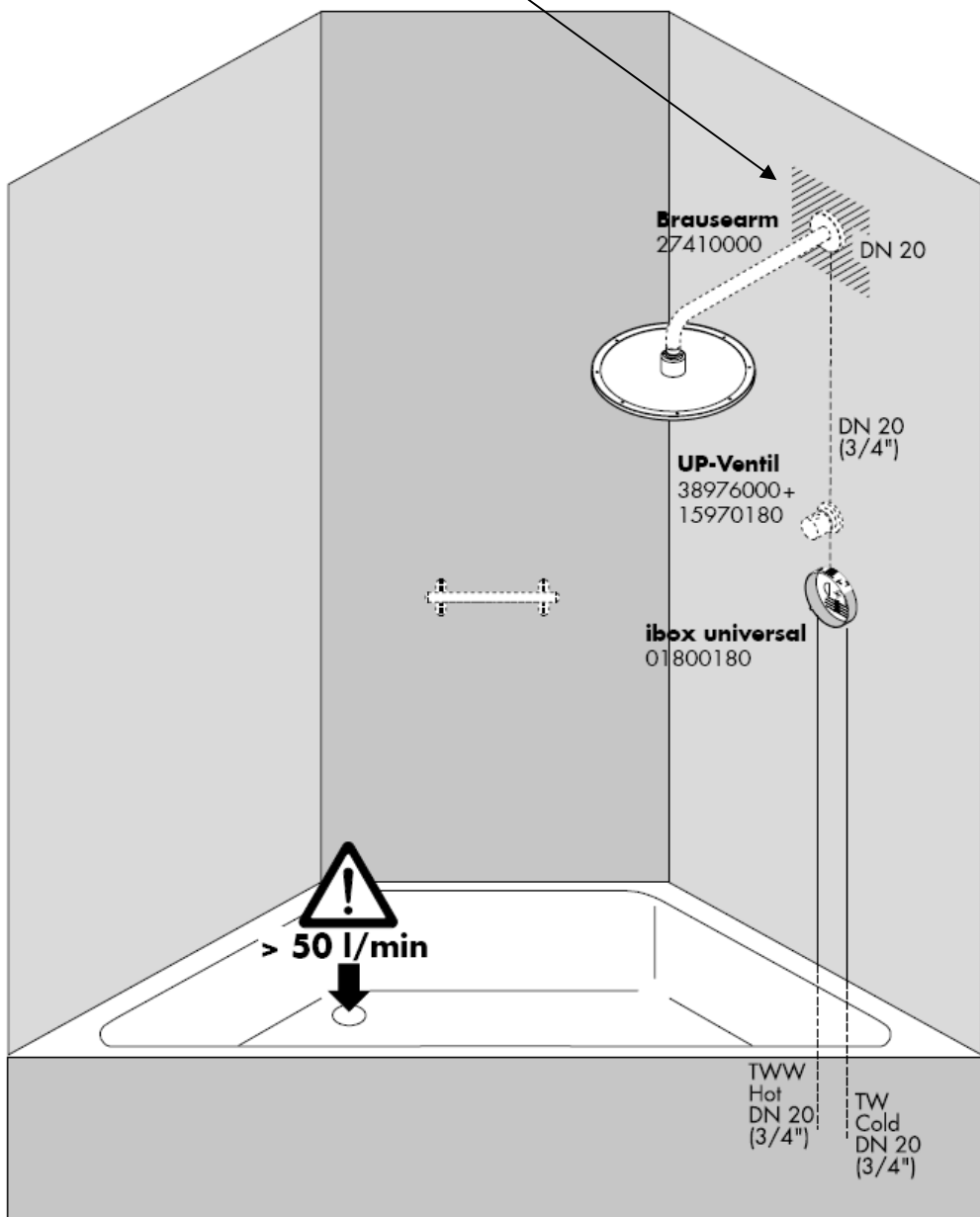

Nuo • funkcionavimas garantuotas

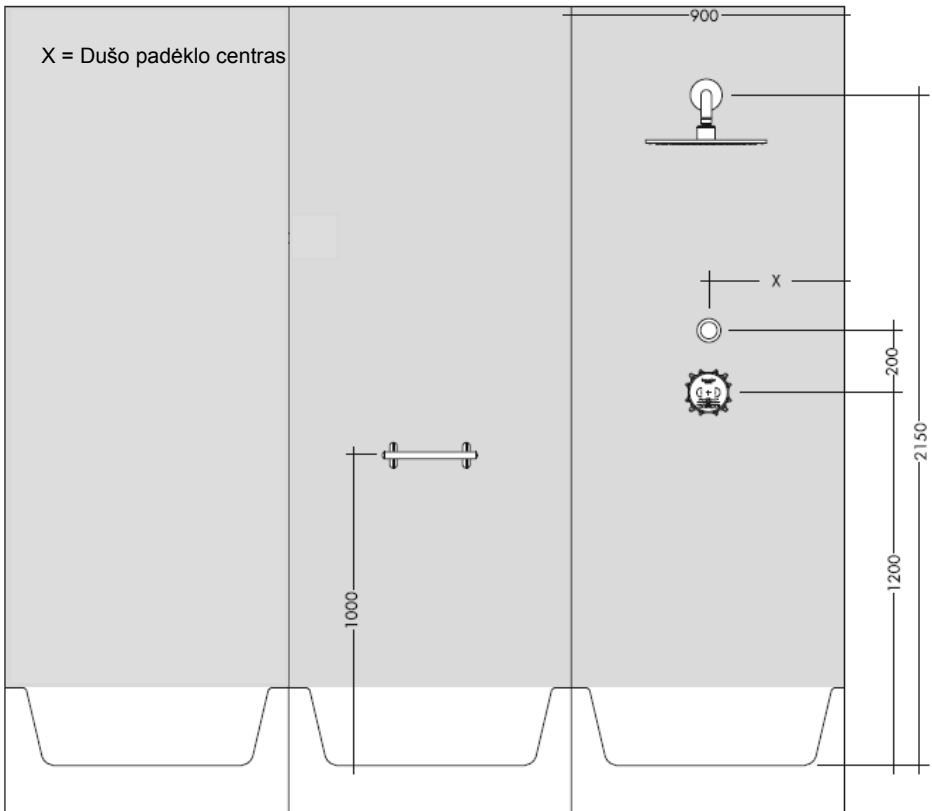
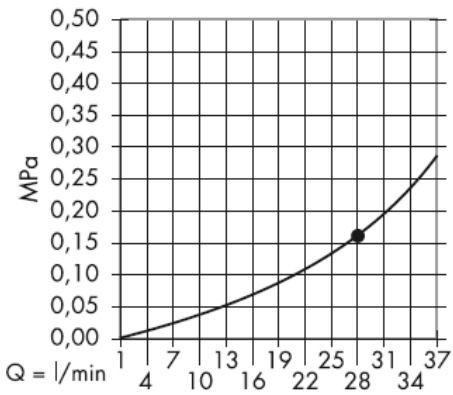

Dušo vamzdžiui tvirtinti būtinas tvirtinamasis sienos elementas

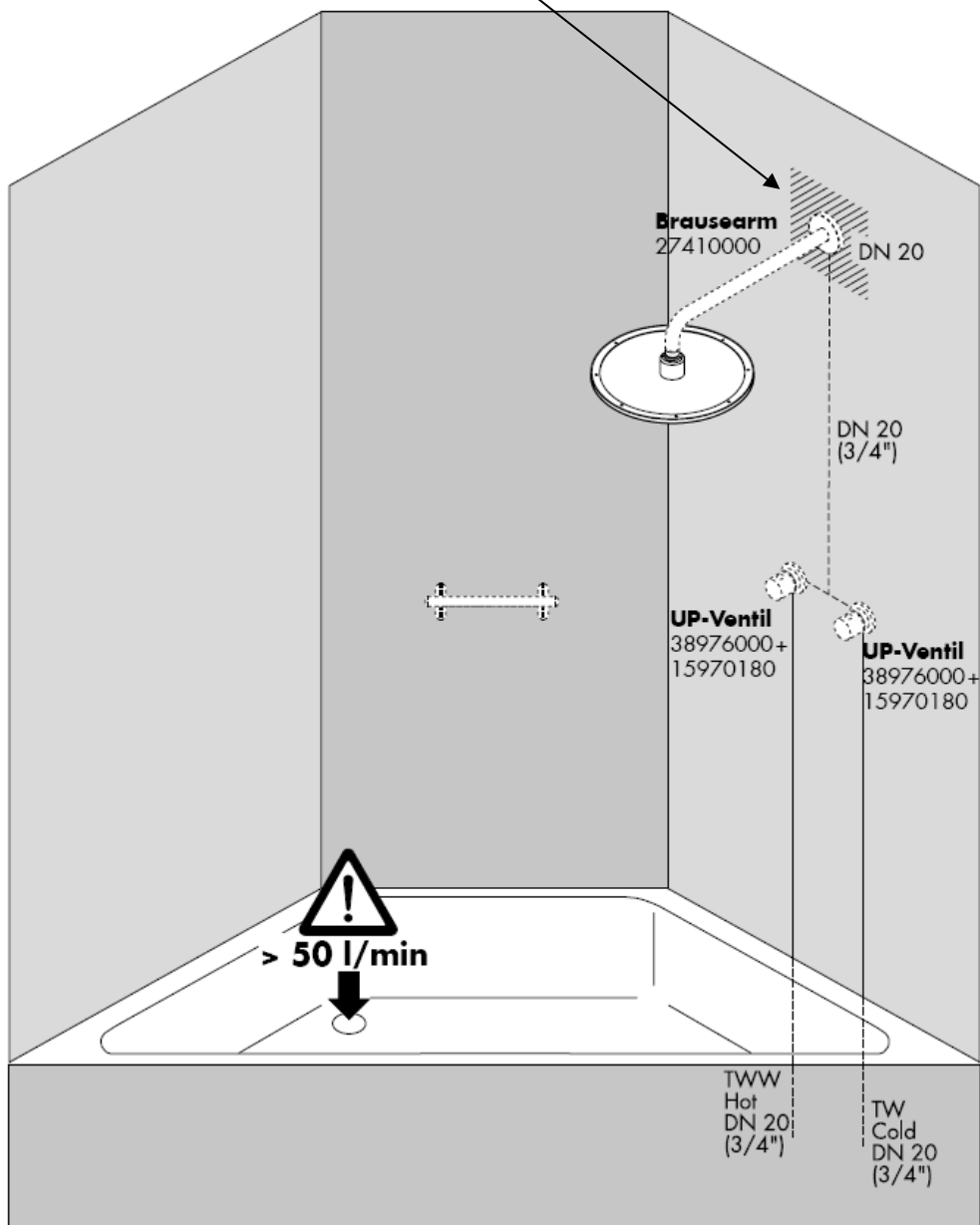

Nuo • funkcionavimas garantuotas

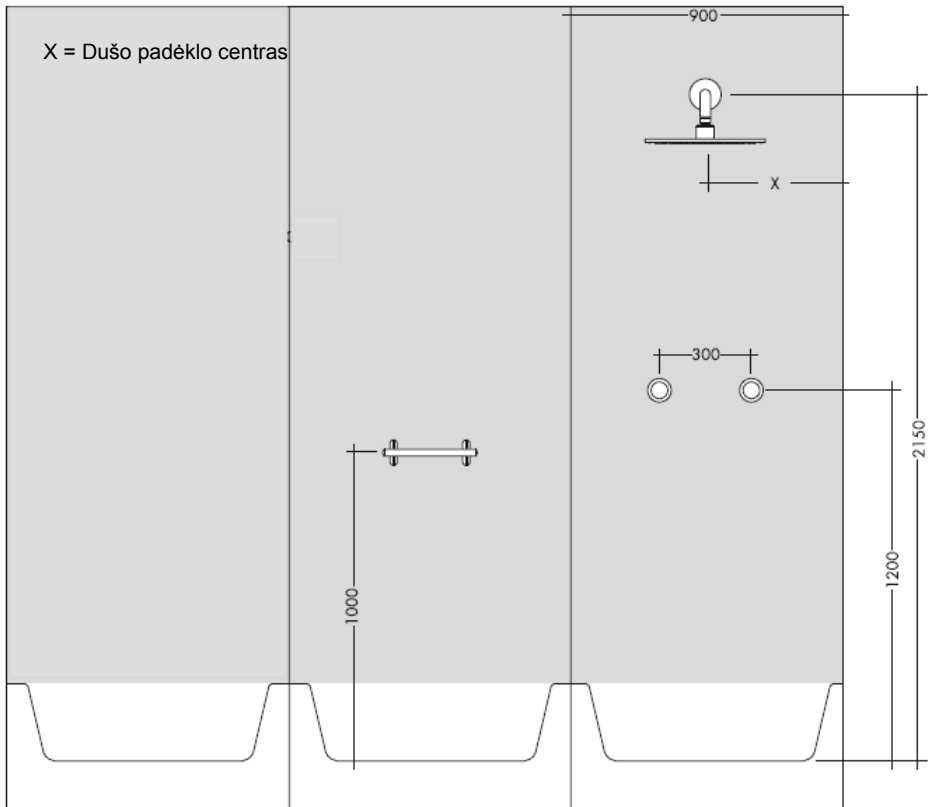
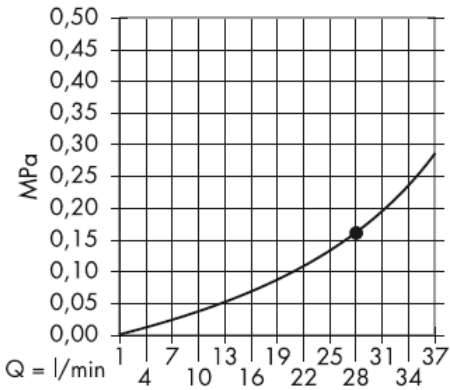

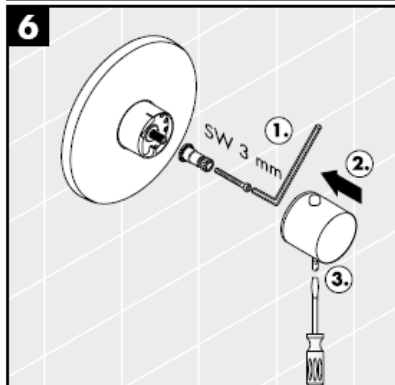
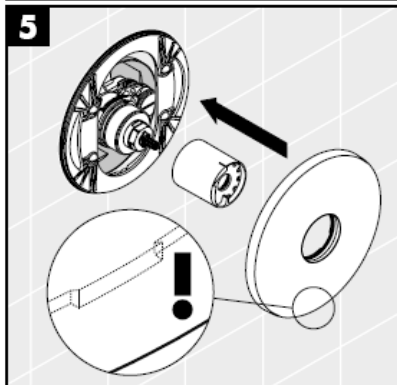
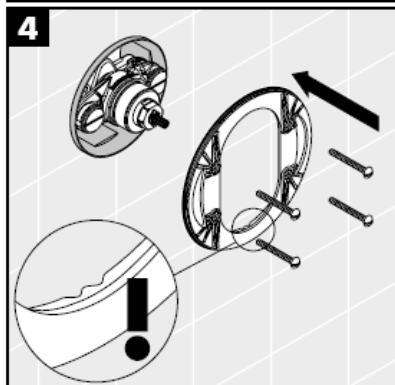
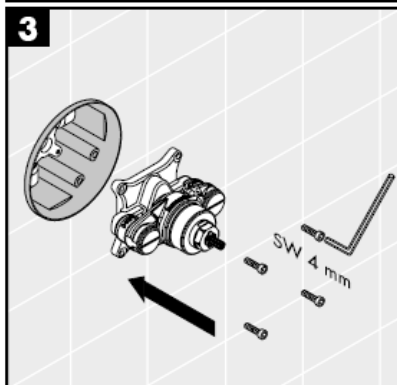
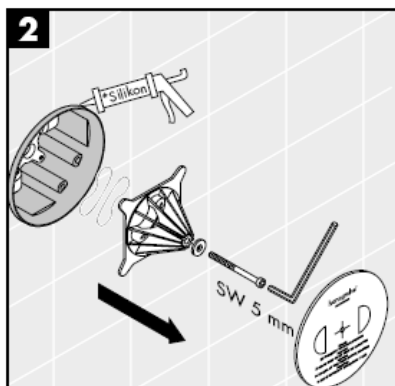
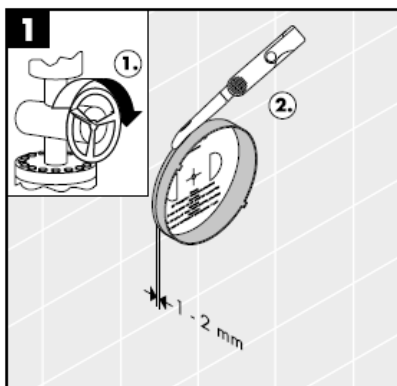

Silikonas (be acto rūgšties!)

"Safety" funkcija karšto vandens temperatūra gali būti iš anksto ribota iki, pvz., ne aukštesnės kaip 42 C.

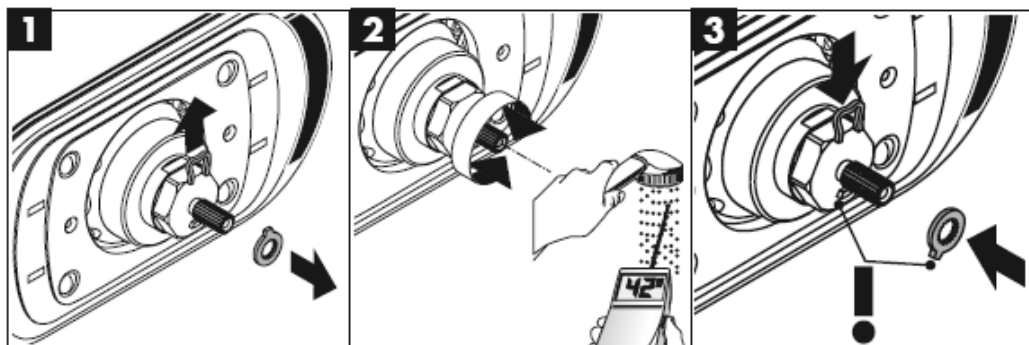

Nustatymas

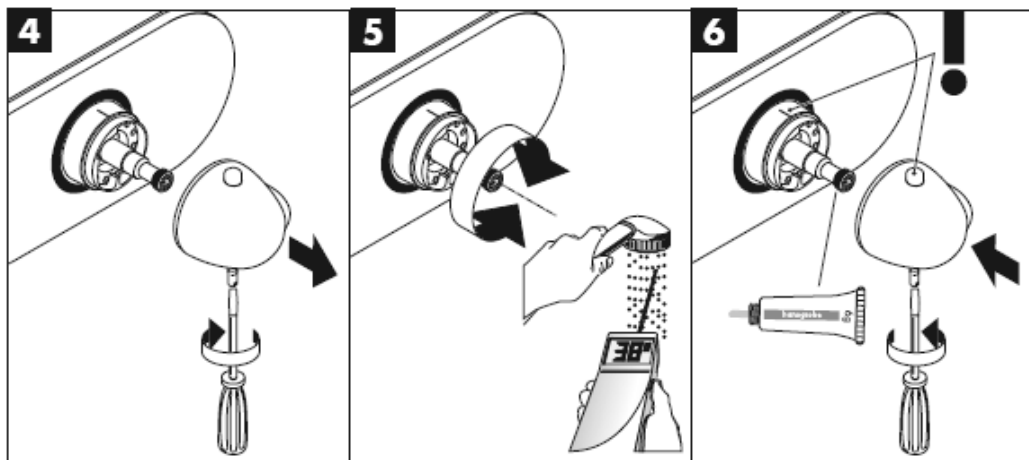



Kai dušas veikia, jis kartu su laikikliu sveria apie 10 kg. Todėl reikia naudoti tik mūro sienai tinkamas tvirtinimo medžiagas! Pridėti varžtai ir tvirtinimo elementai tinka tik masyvaus mūro sienai.

Naudokite tik mūrrijimui naudojamą rišančią medžiagą! Pakuotėje esantys varžtai pritaikyti tik vientiso mūro sienai.

Vandens išleidimas privalo būti pakankamo dydžio.

Optimali funkcija garantuojama tik su "Hansgrohe" "High Flow" didesnio pralaidumo termostatu.

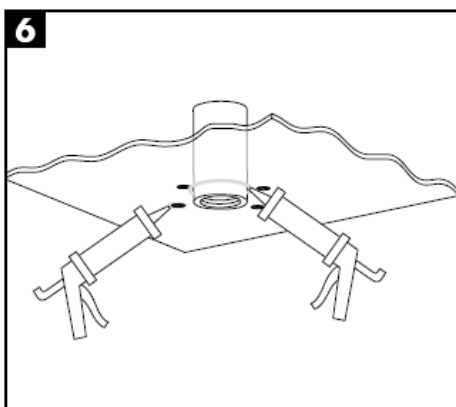
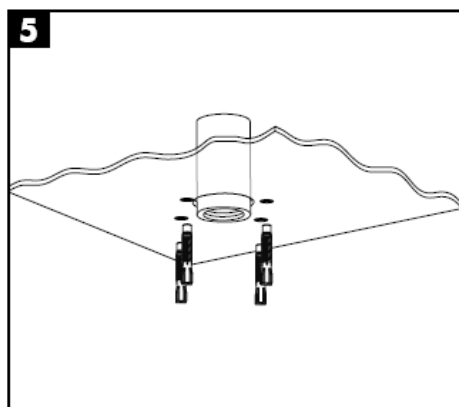
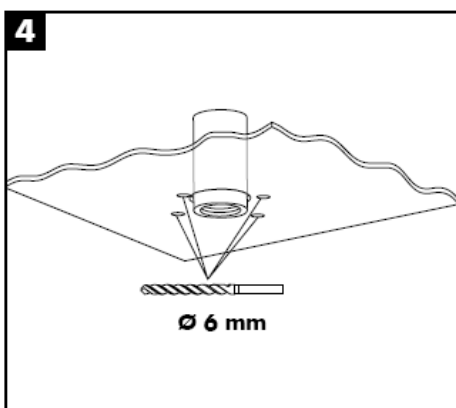
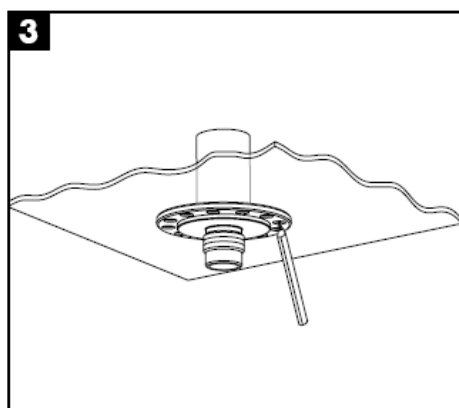
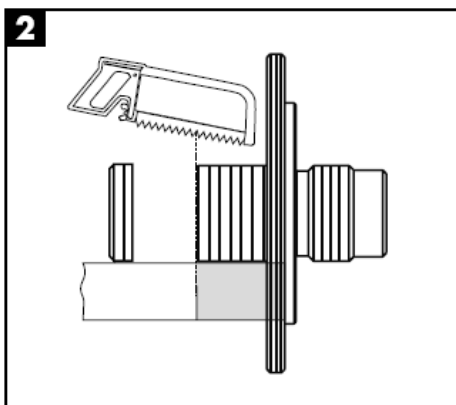
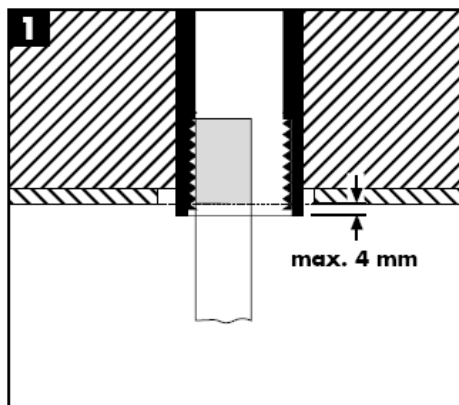

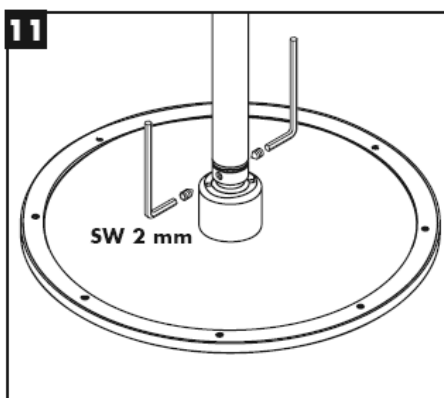
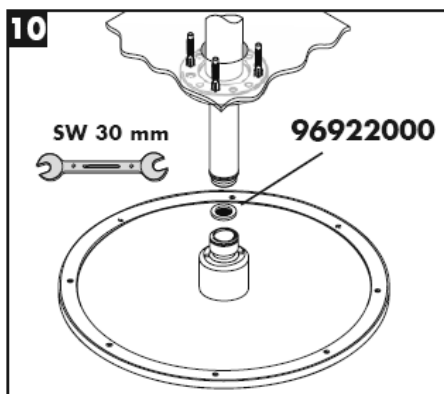
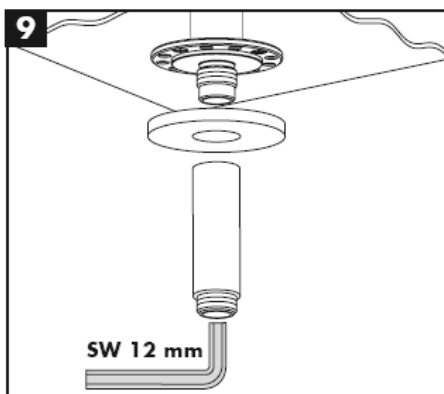
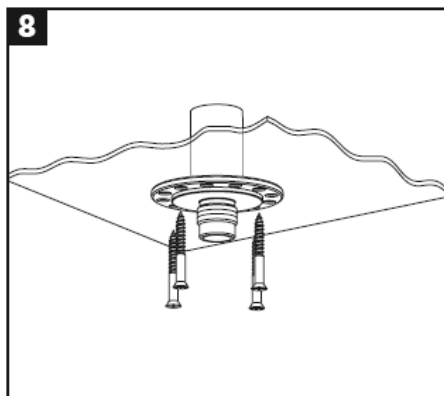
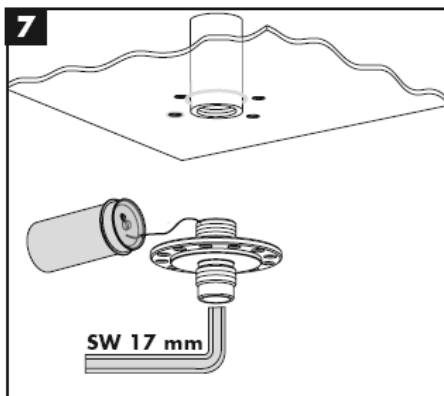

Tinklelis, kuris yra rankų dušass pakuotėje, privalo būti įstatytas, kad būtų apsaugota nuo išorės nešvarumų. Nešvarumai gali pakenkti rankų dušass funkcionalumui ir (arba) sugadinti rankų dušass funkcinės dalis. Tokiu atveju "Hansgrohe" atsakomybės neprisiima.

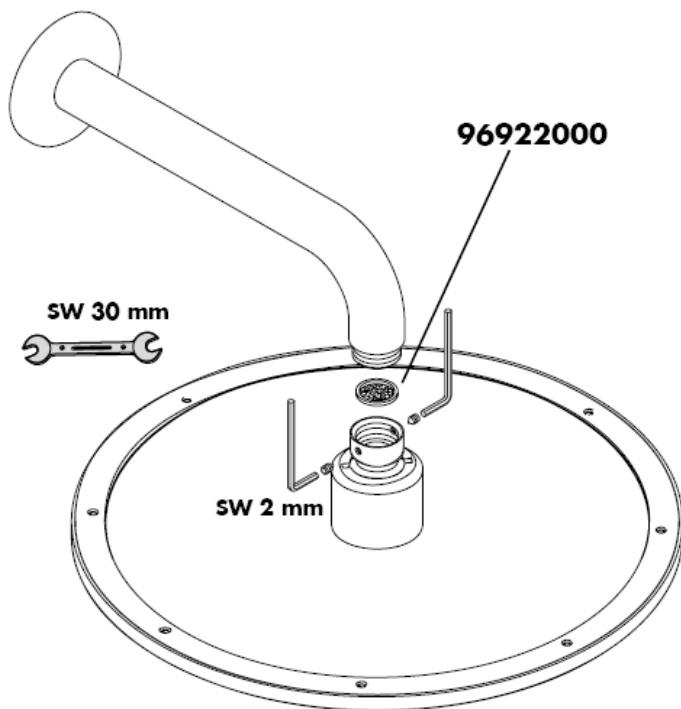

Montavimas

Dėmesio! Maišytuvas privalo būti montuojamas, išleidžiamas ir patikrinamas pagal galiojančias normas!

Nustatymas

Jei ant rankenėlės nurodyta temperatūra nesutampa su esama, ją reikia pareguliuoti. Temperatūrą reguliuokite taip: sukite temperatūros rankenėlę, kol vandens temperatūra taps 38 C. Atsukite varžtą, pakeiskite ribotuvo nuostatas, ir rankenėlę vėl prisukite (žr. 22 psl.)

temperatūros ribotuvus

Sumaišyto vandens temperatūra ribota 38 C (100 F). Jei reikia karštesnio vandens, nuspausti saugos mygtuką ir pasukti rankenėlę iki norimos temperatūros.

Apsaugos funkcija

"Safety" funkcija karšto vandens temperatūra gali būti iš anksto ribota iki, pvz., ne aukštesnės kaip 42 C. žr. psl. 21.

Techniniai duomenys

Darbinis slėgis: max. 1 MPa
 Rekomenduojamas slėgis: 0,1 – 0,5 MPa
 Bandomasis slėgis: 1,6 MPa
 (1 MPa = 10 barų = 147 PSI)
 Karšto vandens temperatūra: max. 80° C
 Rekomenduojama karšto vandens temperatūra: 65° C
 Vandens pralaidumas: ca. 58 l/min 0,3 MPa

Techninis aptarnavimas

Termostatams nereikia specialios priežiūros. Atbulinio vožtuvo apsauga privalo būti tikrinama reguliariai (mažiausiai kartą per metus pagal DIN 1988) pagal DIN EN1717 arba pagal galiojančias nacionalines arba regionines normas. Tuo pačiu būtina patikrinti filtrą, kuris yra ant termoelemento sienelės (6.1). Pakeitus termoelementą (6), būtina patikrinti vandens temperatūrą ir nustatyti karšto vandens ribojimą (žr. temperatūros nustatymą). Prieš reguliavimą patikrinkite, ar tiekiamas karštas vanduo ir kokia jo didžiausia temperatūra ištekėjimo vietoje.

Tam, kad būtų garantuotas tolygus temperatūros reguliavimas ir ilgas naudojimas, būtina periodiškai temperatūros rankenėlę pasukti į karščiausios ir šalčiausios temperatūros padėtį.

Atsarginės dalys žr. psl. 3

1	termostato rankenėlė	38391000
2	Dangtis	96452000
3	mova	97439000
4	fiksavimo varžtai	96454000
5	Dangčio laikiklis	96447000
6	temperatūros reguliatorius	96633000
7	filtras	97367000
8	atbulinis vožtuvas	96655000
9	Ilgiklis 25 mm	13595000
10	Ilgiklis 25 mm	13596000

Lietuviškai

Gedimas	Priežastis	Priemonė
Per maža srovė	-Slėgis nepakankamas -Užsikimšęs temperatūros regulatoriaus filtras -Dušo galvos filtras užsikimšęs	-Patikrinti vamzdžių spaudimą -Išvalyti filtrą -Išvalyti dušo galvos filtrą
Kryžminis tekėjimas, uždarius maišytuvą, karštas vanduo papuola į šalto vandens vamzdį	-Atbulinis vožtuvas užsikimšęs / pažeistas	-Pakeisti atbulinį vožtuvą
Vandens temperatūra nesutampa su nustatyta temperatūra	-Termostatas nereguliuotas -Per maža karšto vandens temperatūra	-Reguliuoti termostatą -Karšto vandens temperatūrą pakelti nuo 42 °C bis 65 °C
Temperatūros reguliavimas neįmanomas	-Temperatūros regulatorius užsikimšęs arba apkalkėjęs -Sumontuoti funkcijos blokavimą 180	-Neteisingai prijungti vamzdžiai: karštas turi būti kairėje, šaltas - dešinėje -Ribotuvo mygtukas neveikia
Spyruoklė pažeista	-Išvalyti spyruoklę/mygtuką ir sutepti arba keisti -Mygtukas apkalkėjęs	-Išvalyti spyruoklę/mygtuką ir sutepti arba keisti -Išvalyti spyruoklę/mygtuką ir sutepti arba keisti

Bandyimo pažyma

	P-IX	DVGW	SVGW	WRSA	KIWA	ACS	NF
27070000						X	
27418XXX							
28420000						X	
28435XXX						X	

Valymas

Paprasta švara: kalkės lengvai
nugrąndomos nuo kilpos.

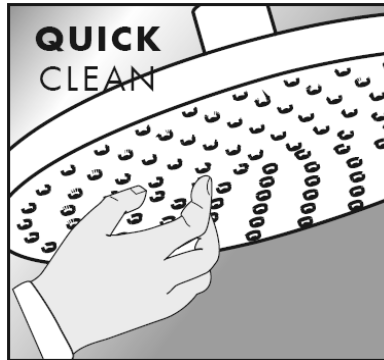

Valymo instrukcijos

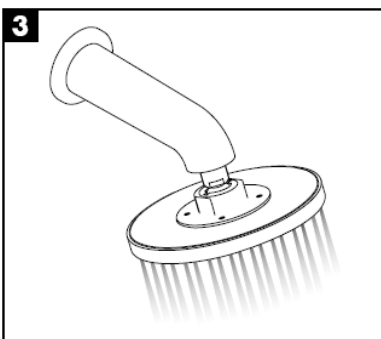
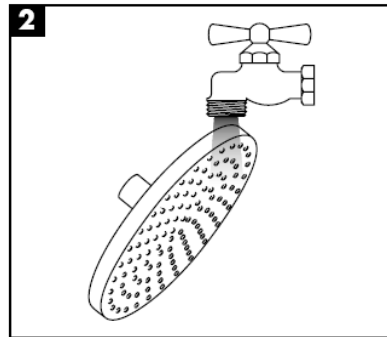
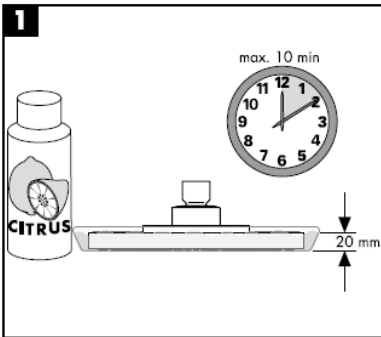

hansgrohe

Uputstva za instalaciju



27418XXX

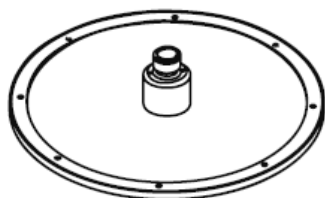

Raindance Royale AIR
28420000

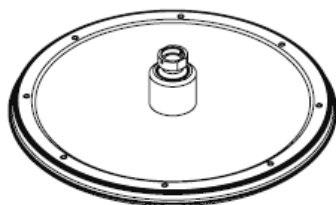

Raindance Royale Classic AIR
28435XXX

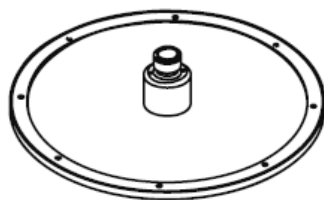

**Raindance Royale
High Flow Set**
27070000

hansgrohe

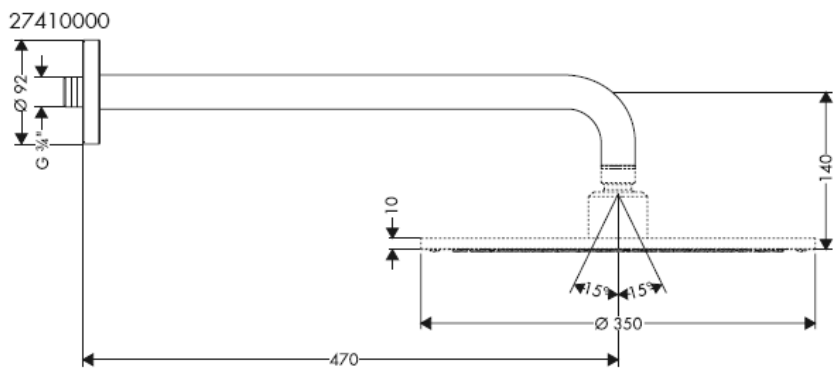
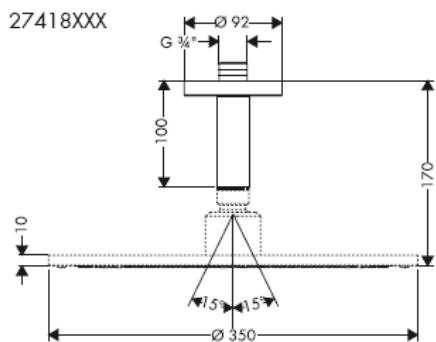
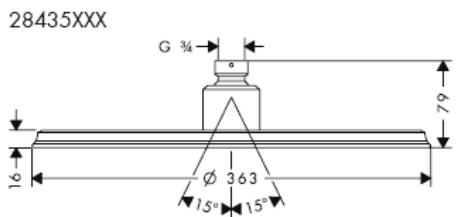
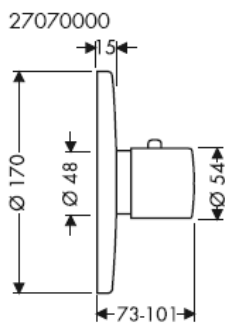
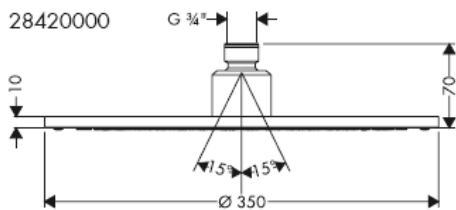

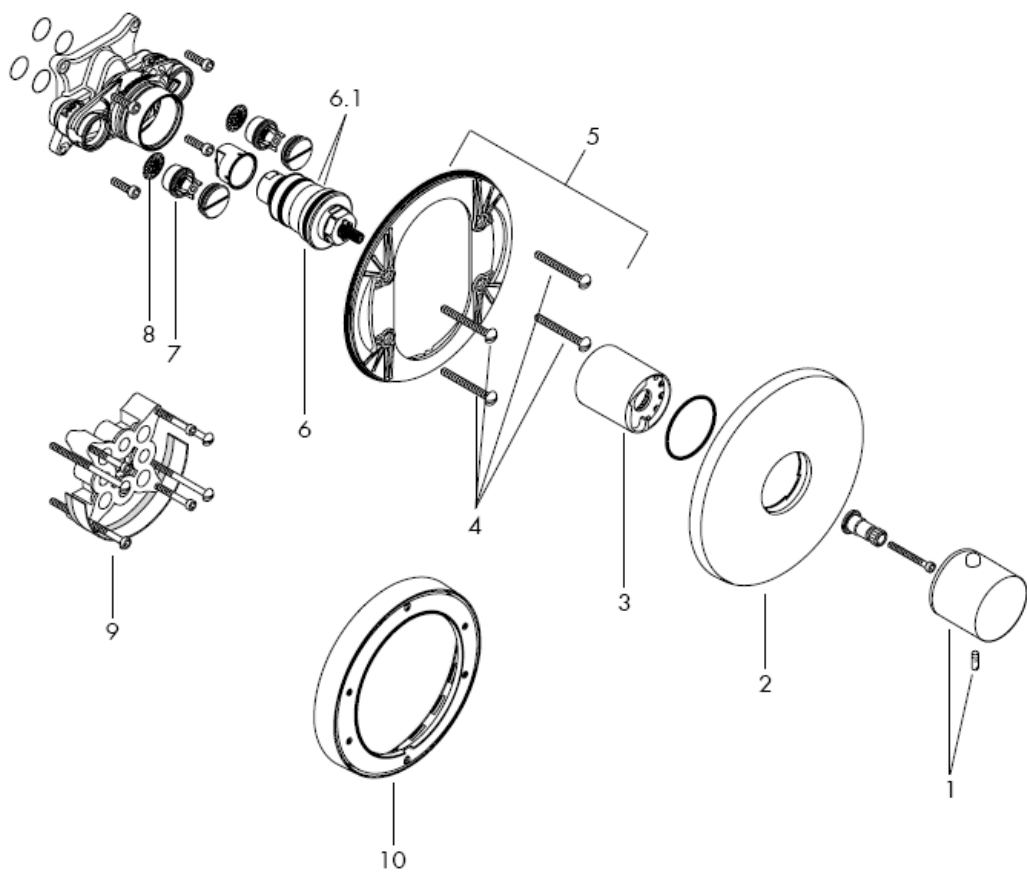

Prilagodite mjeru što je više moguće rasteru pločica

Neophodno ojačanje zida za pričvršćenje ručke tuša

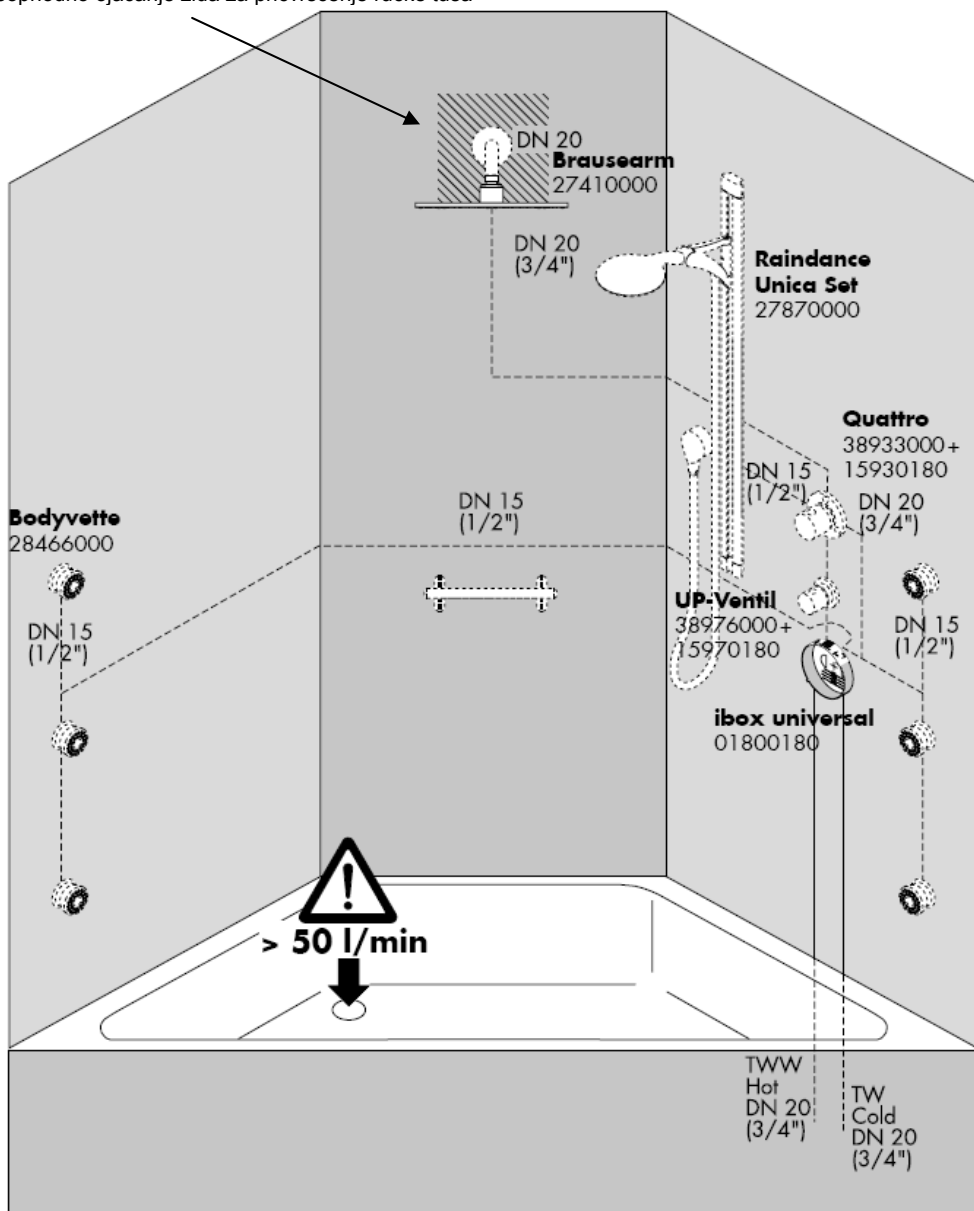

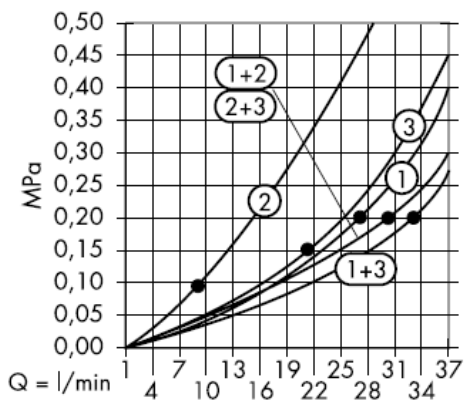

Zajamčena funkcija od • naviše

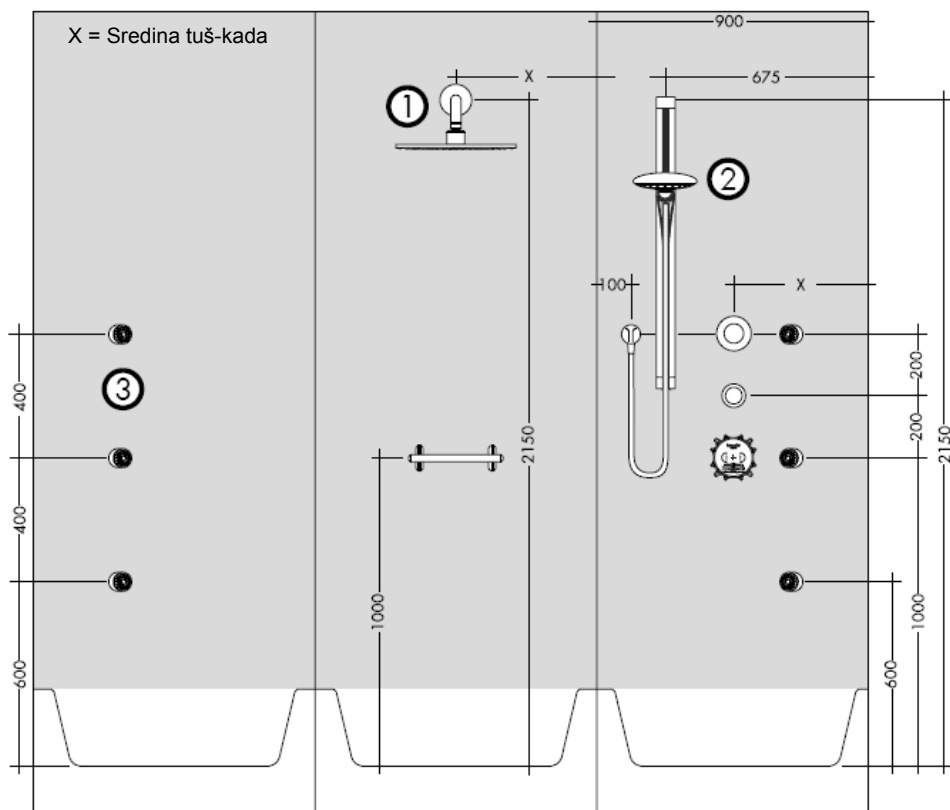

Neophodno ojačanje zida za pričvršćenje ručke tuša

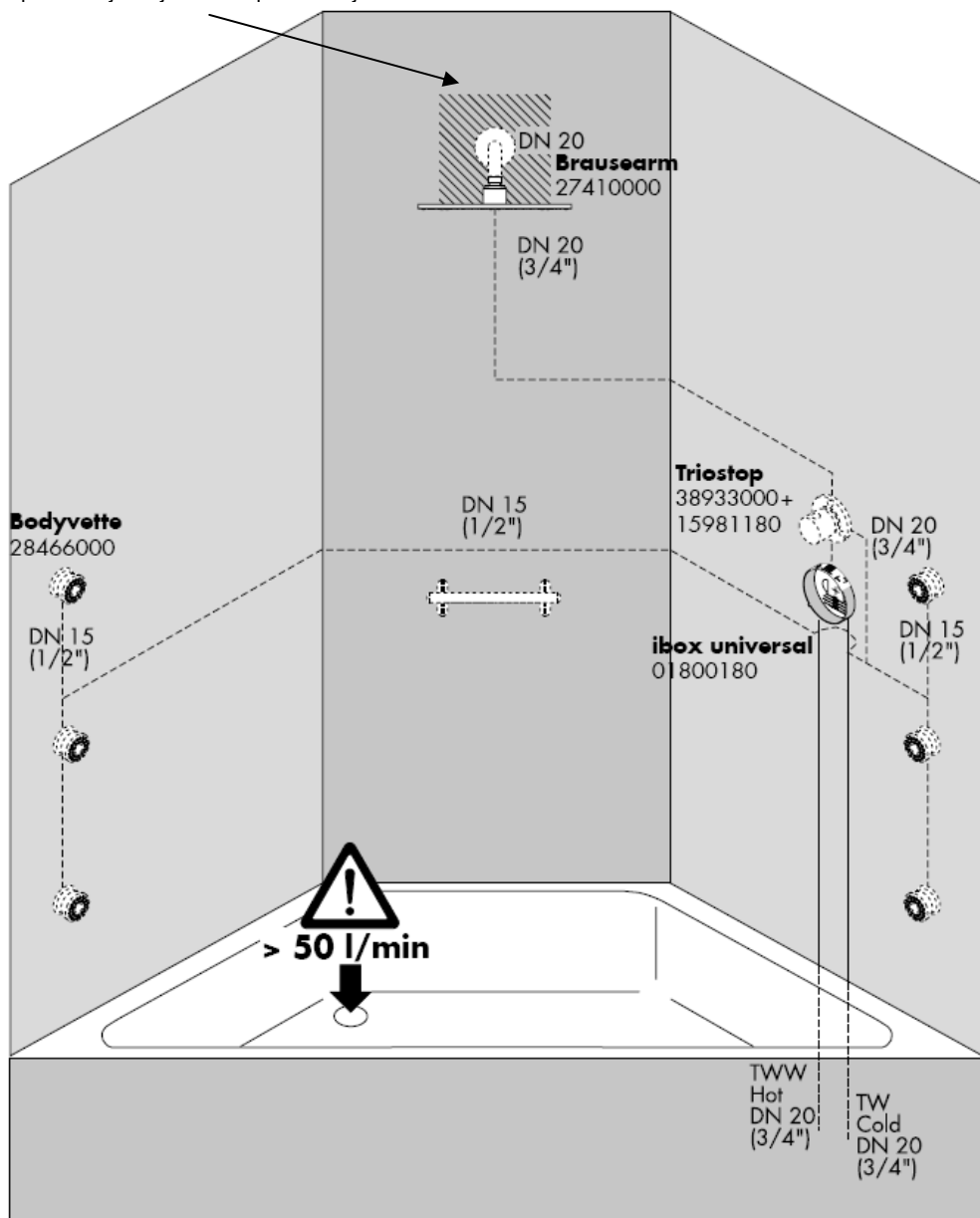

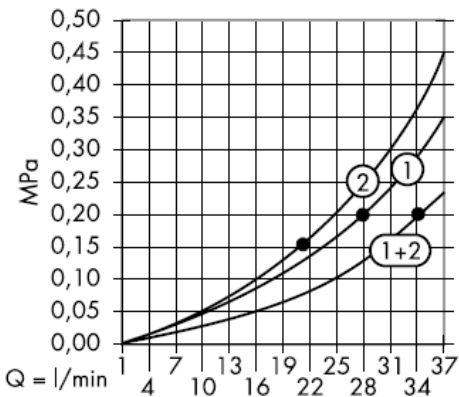

Zajamčena funkcija od • naviše

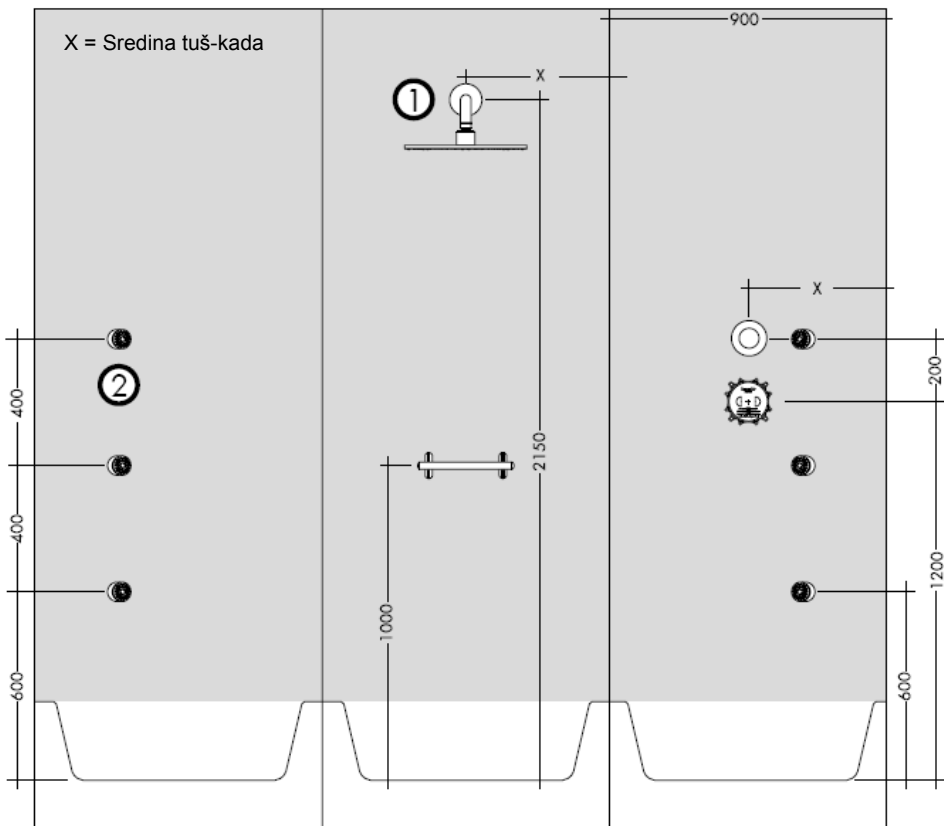

Neophodno ojačanje zida za pričvršćenje ručke tuša

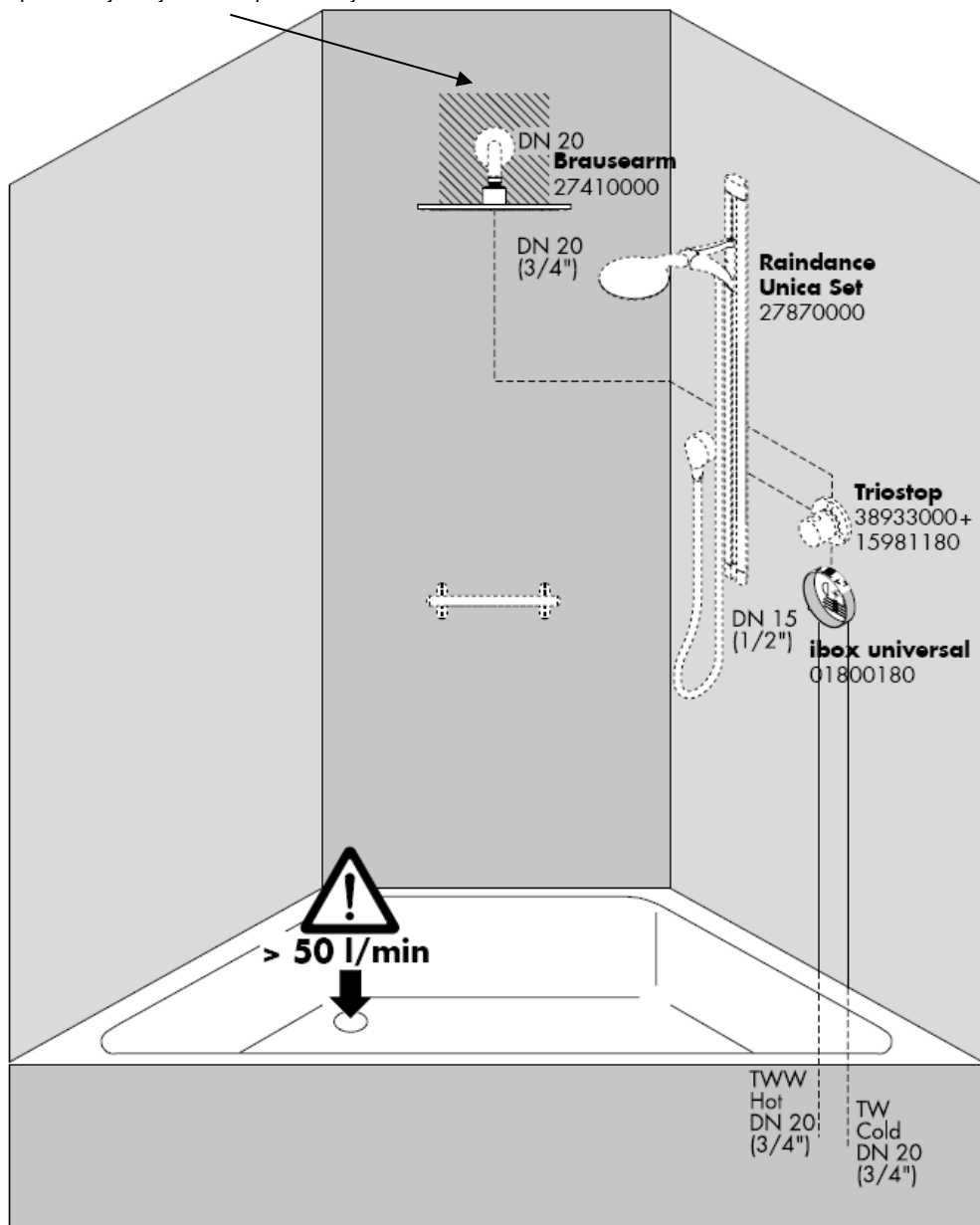

Zajamčena funkcija od • navíše

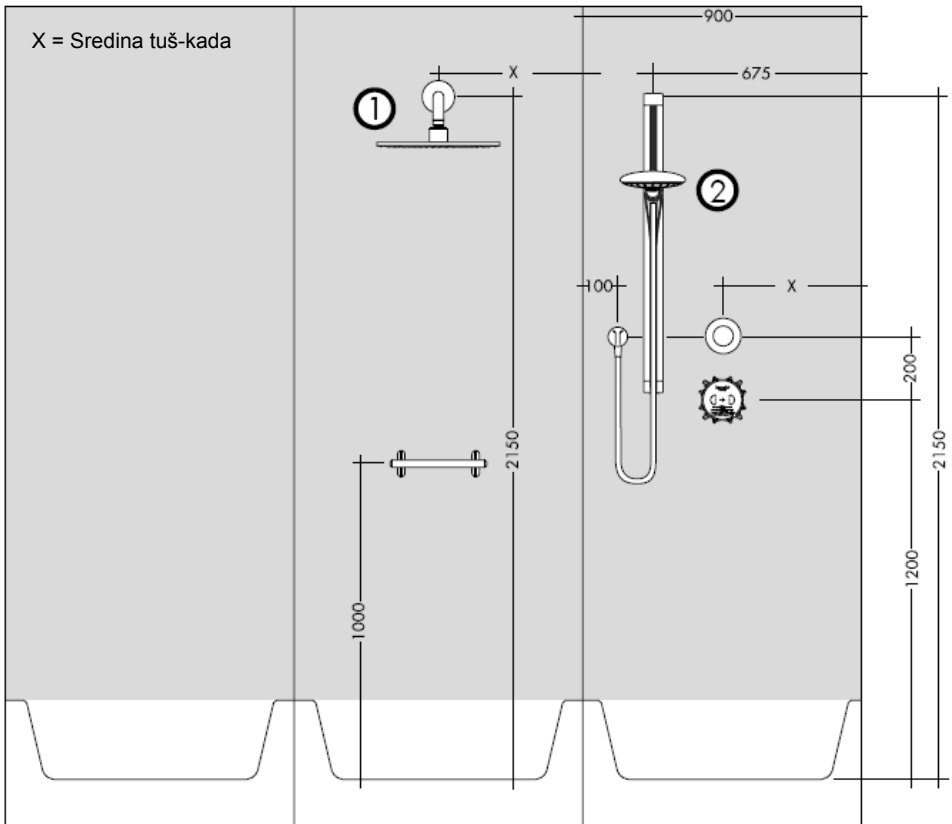
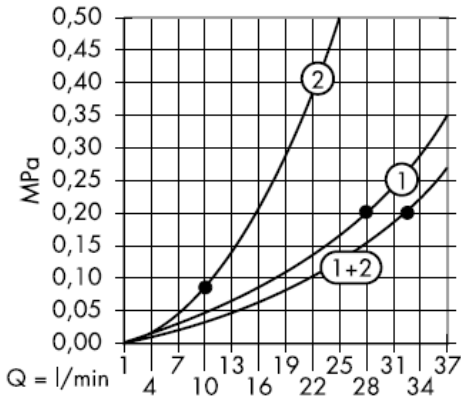

Neophodno ojačanje zida za pričvršćenje ručke tuša

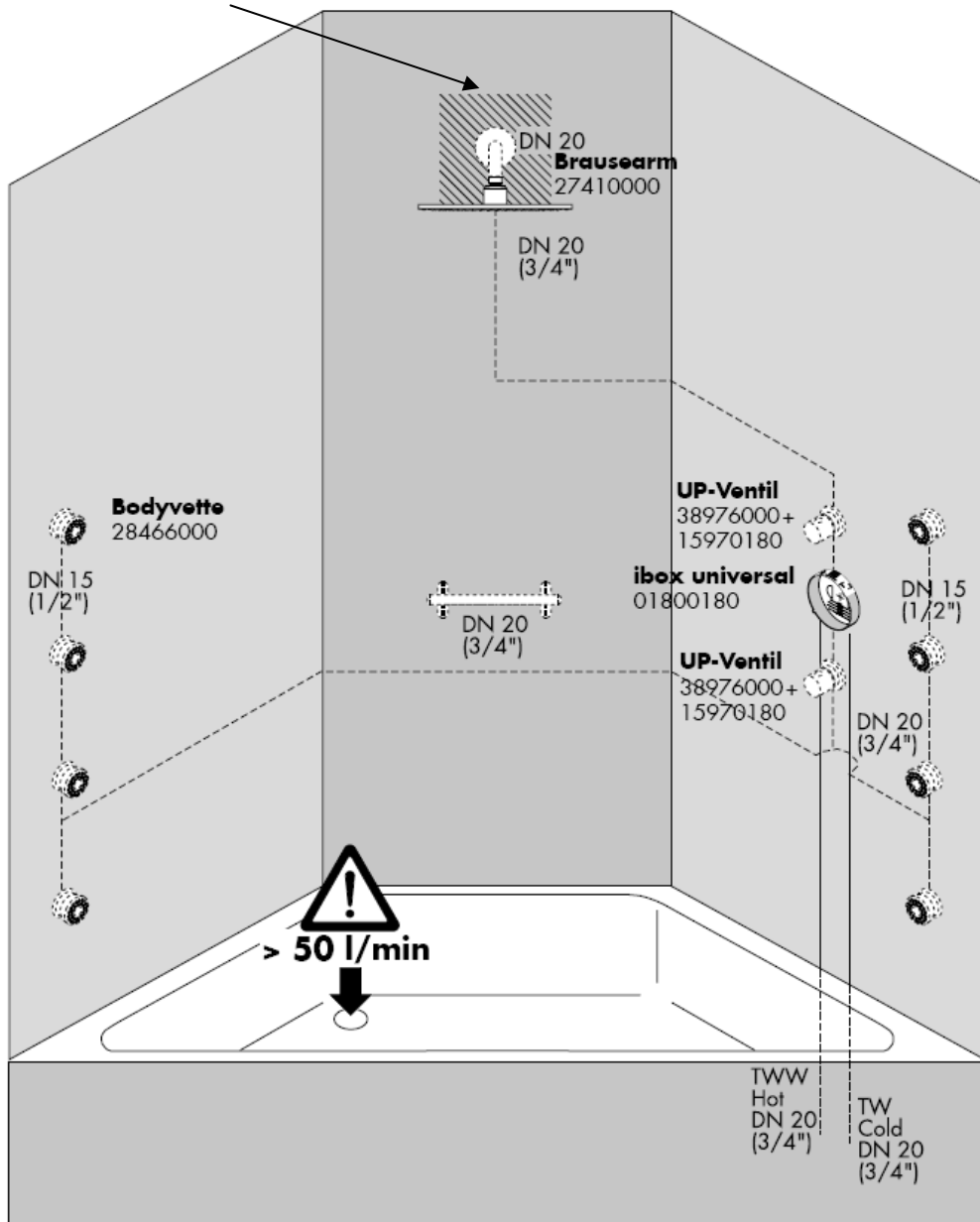

Zajamčena funkcija od • navíše

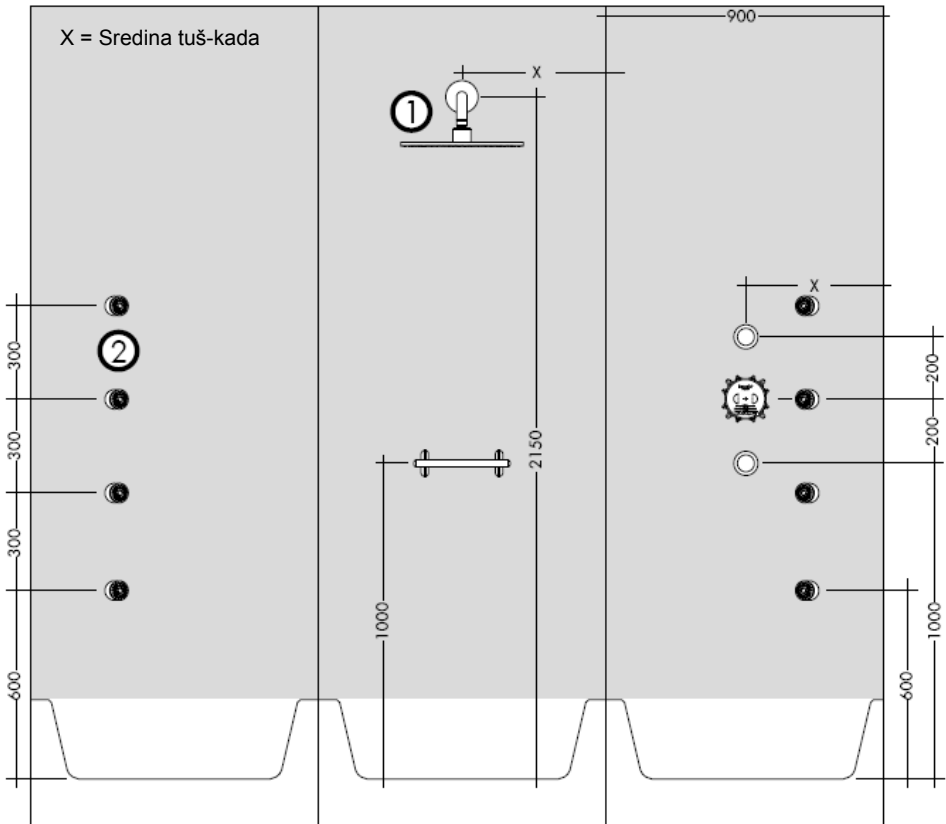
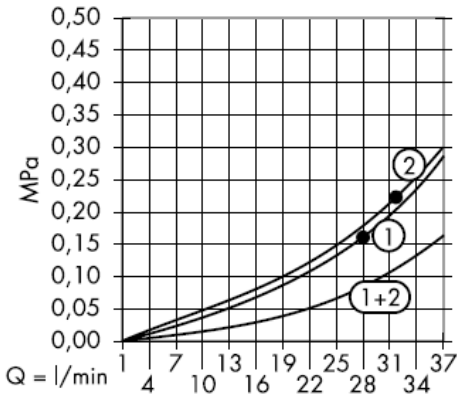

Neophodno ojačanje zida za pričvršćenje ručke tuša

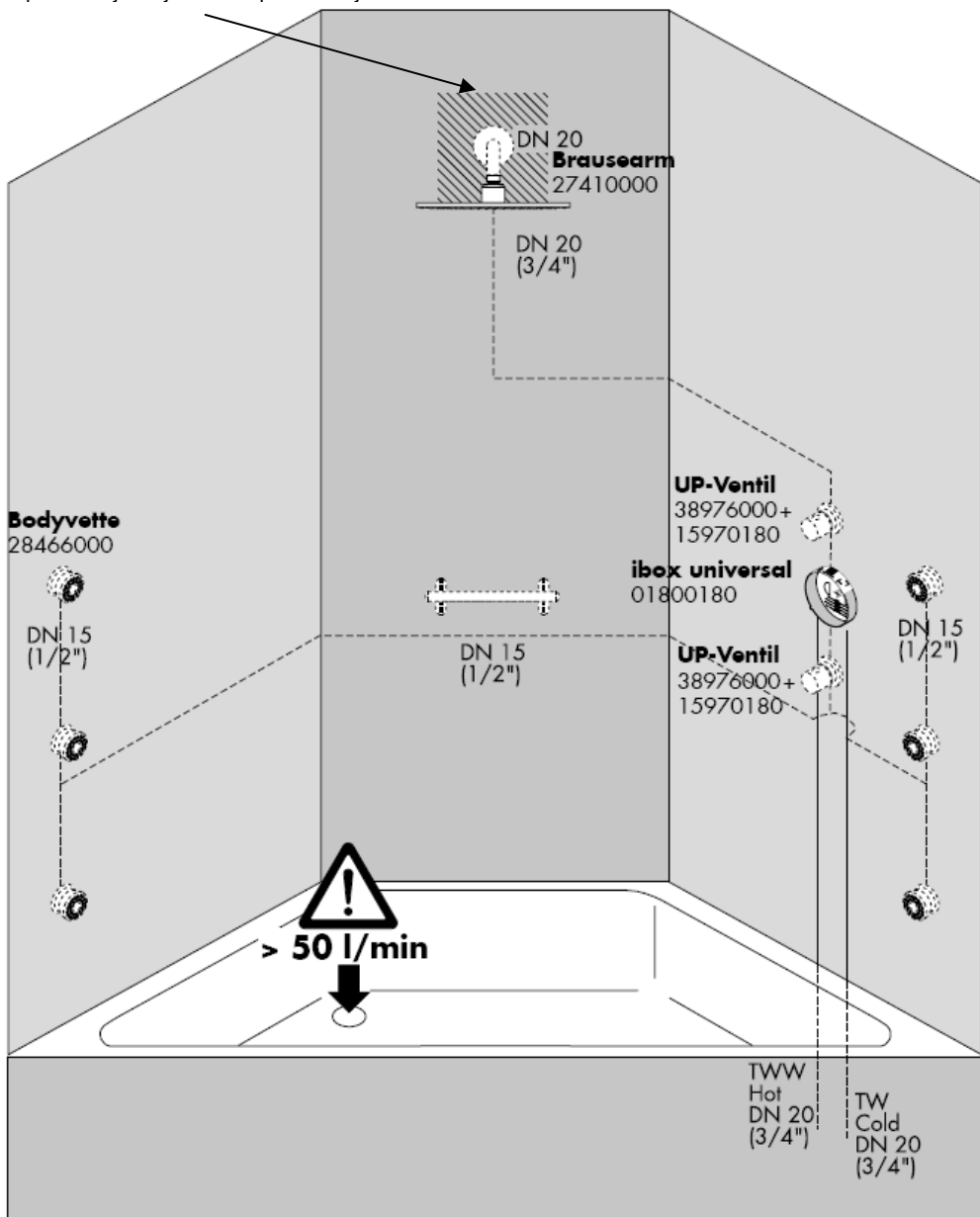

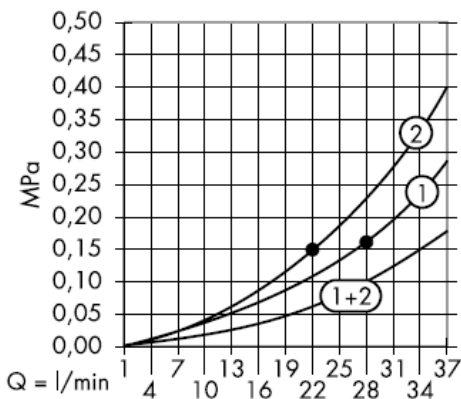

Zajamčena funkcija od • navíše

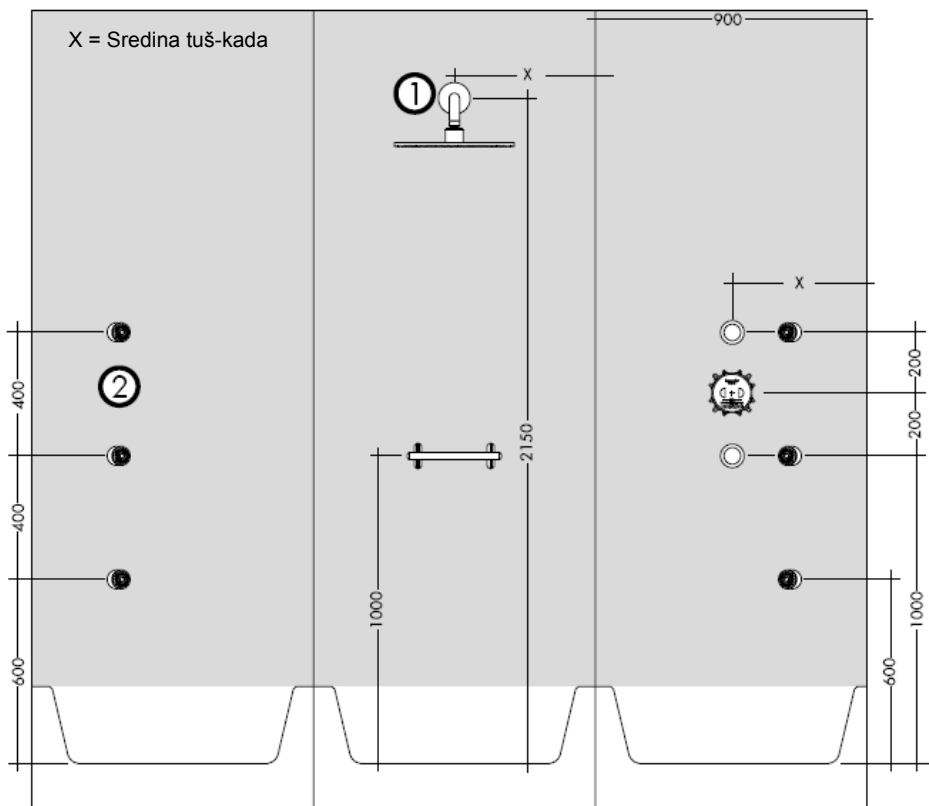

Neophodno ojačanje zida za pričvršćenje ručke tuša

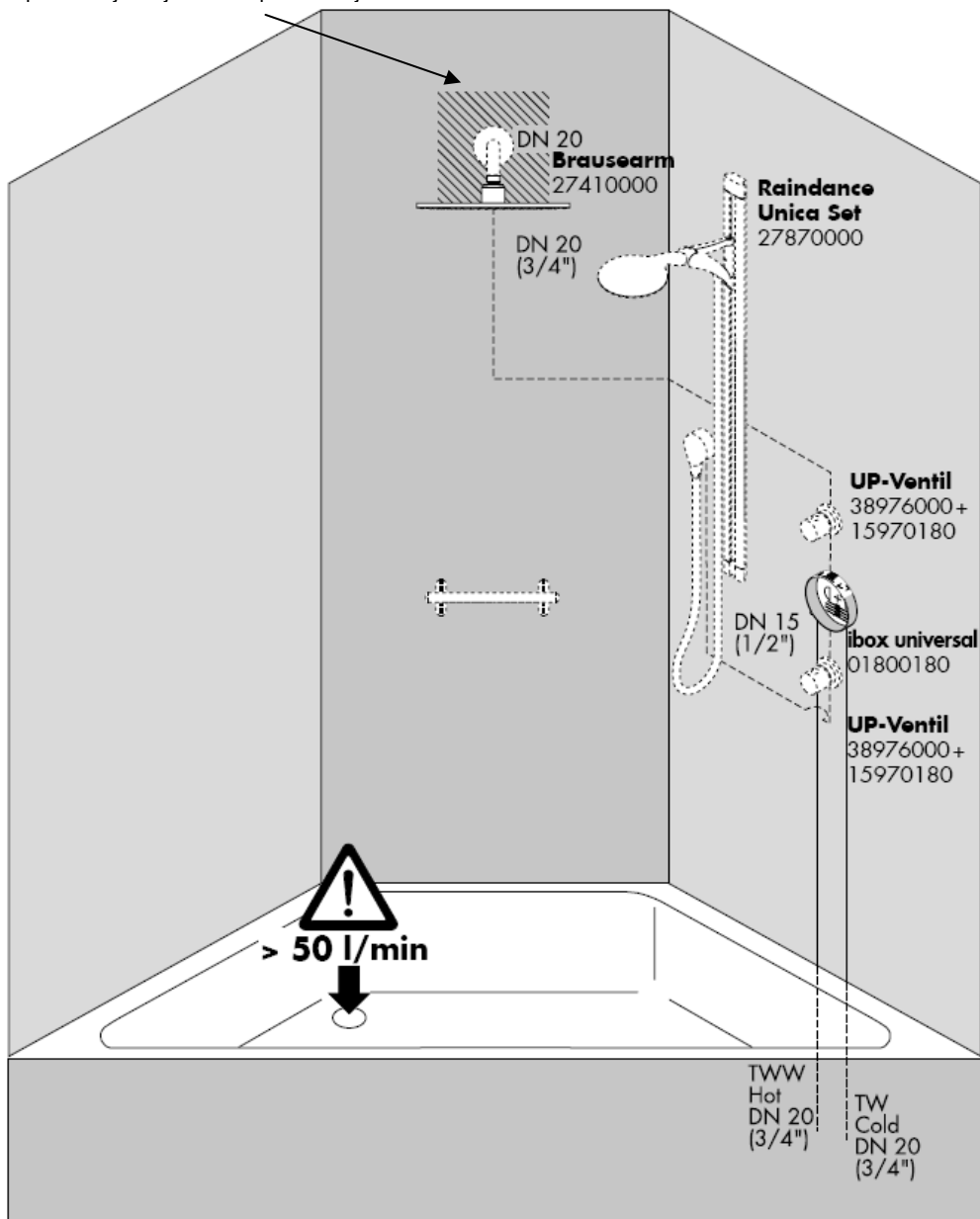

Neophodno ojačanje zida za pričvršćenje ručke tuša

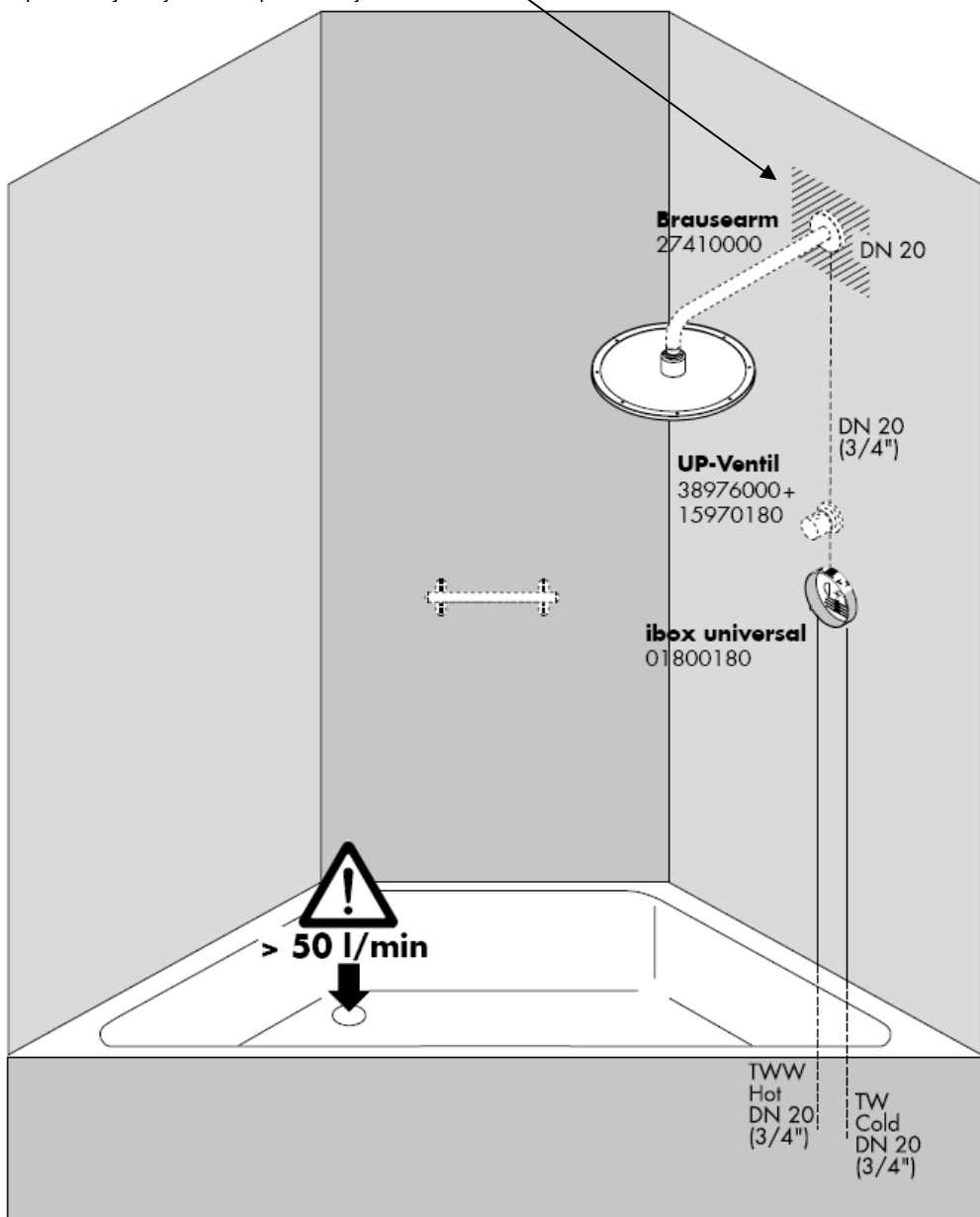

Zajamčena funkcija od • navíše

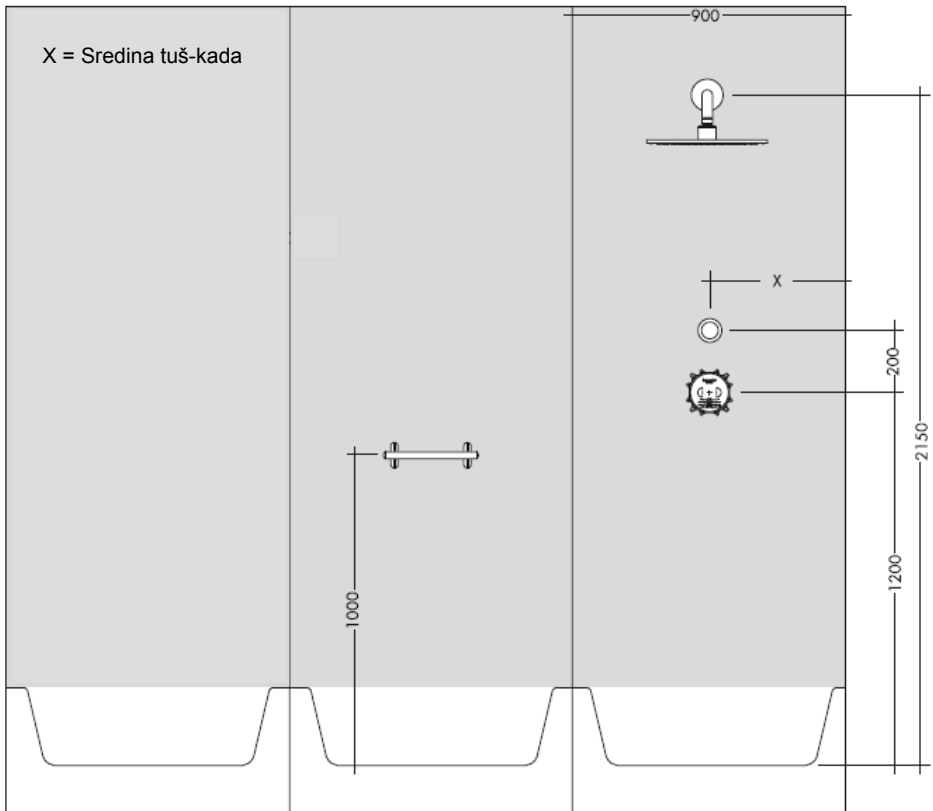
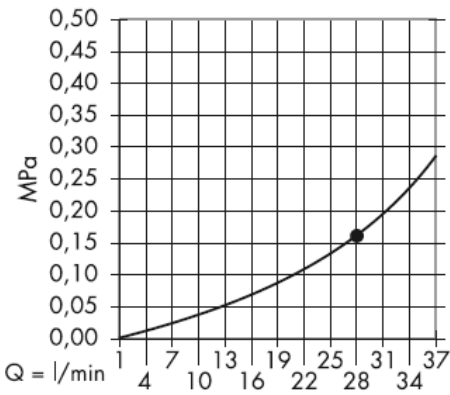

Neophodno ojačanje zida za pričvršćenje ručke tuša

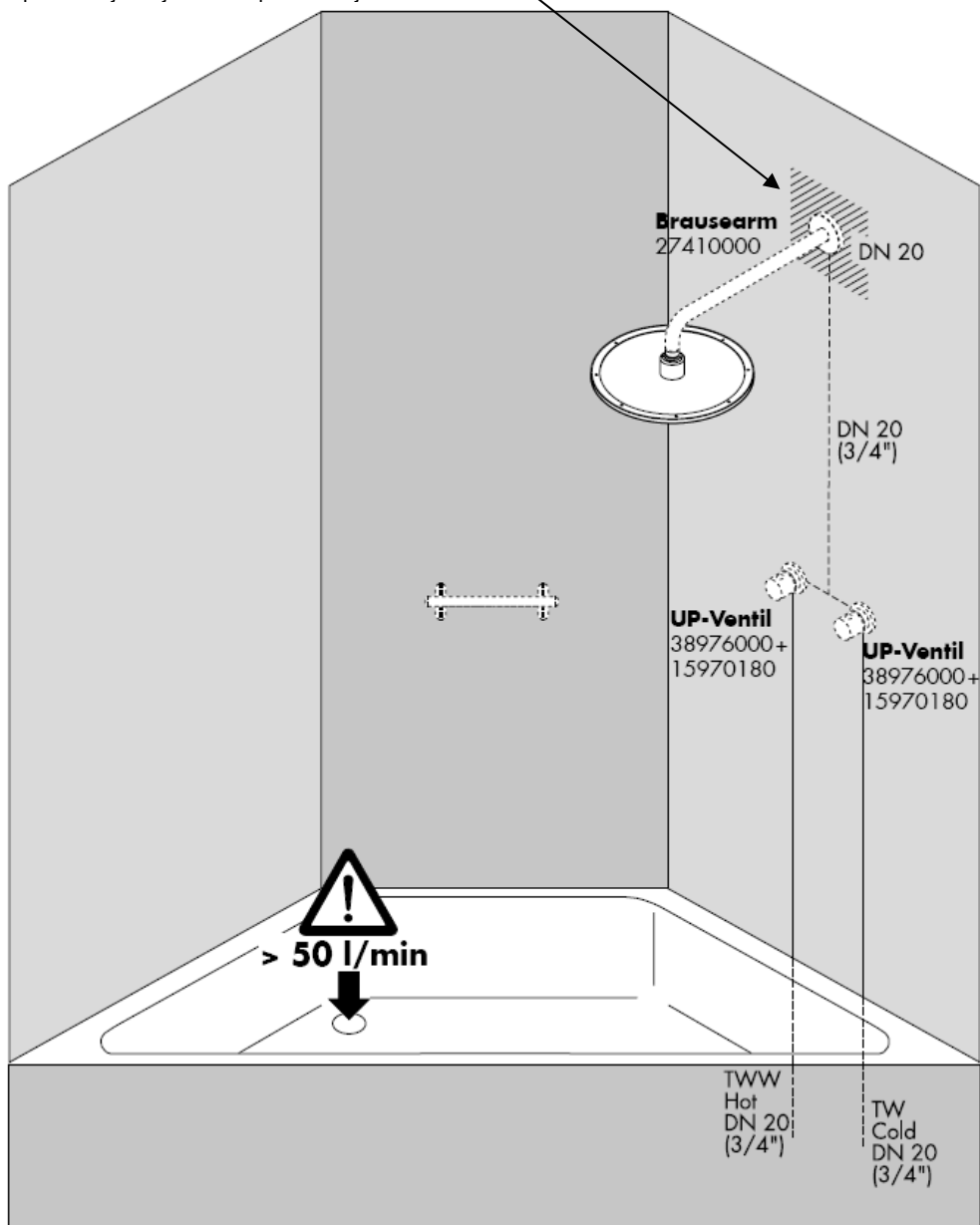

Zajamčena funkcija od • navíše

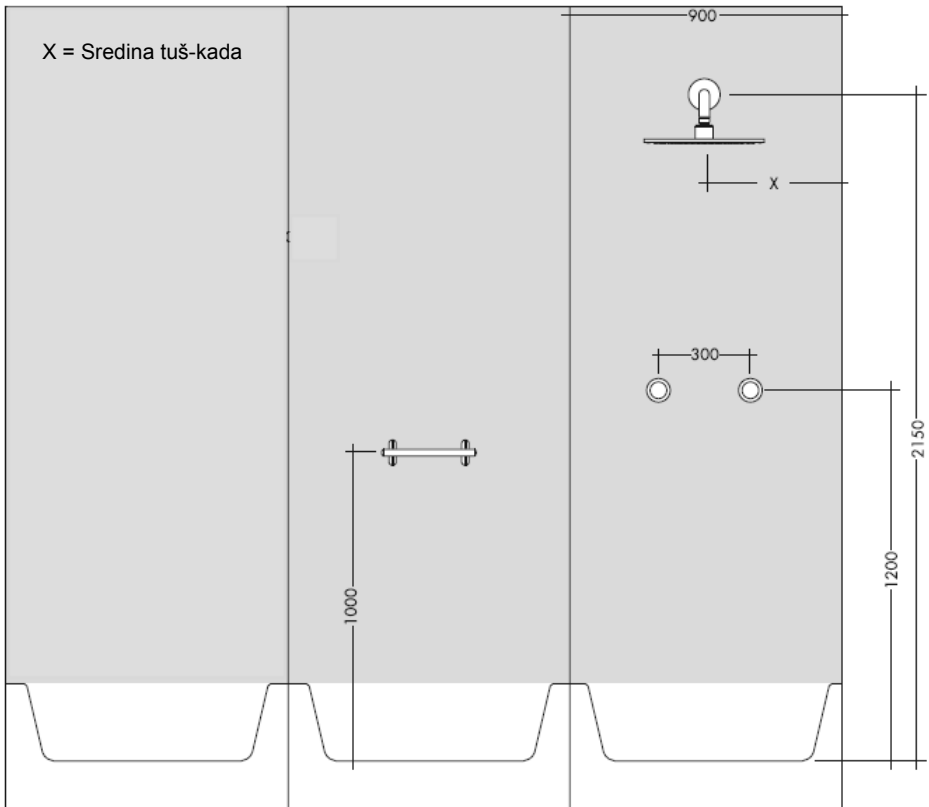
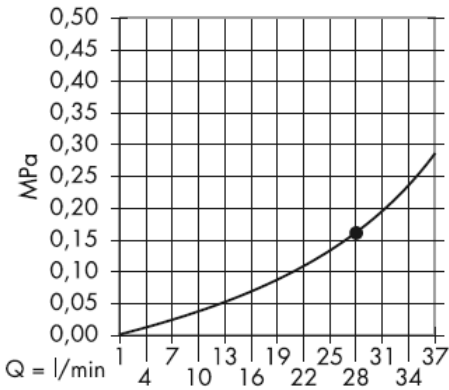

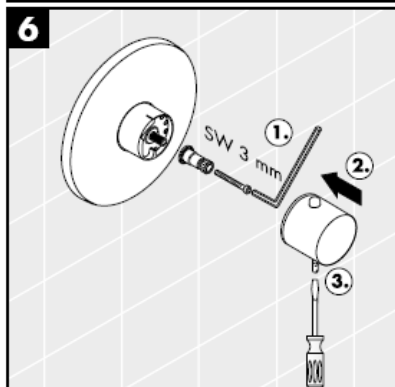
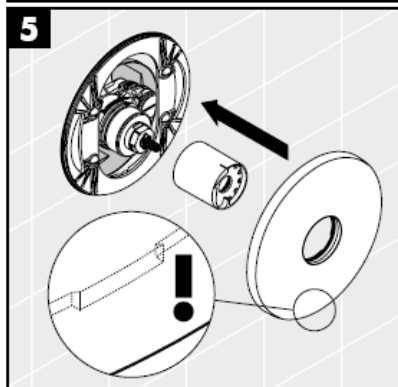
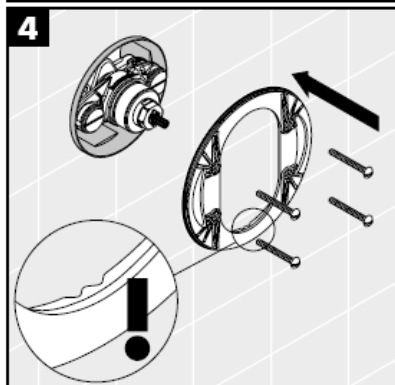
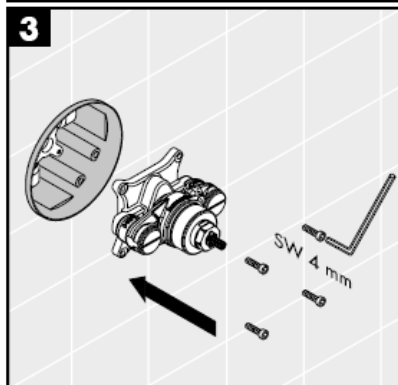
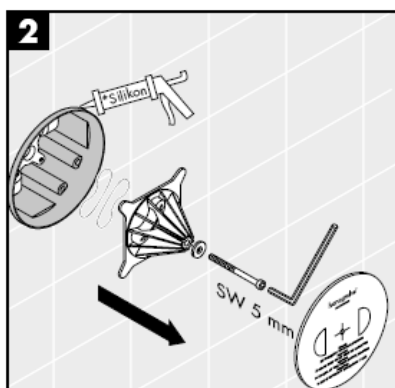
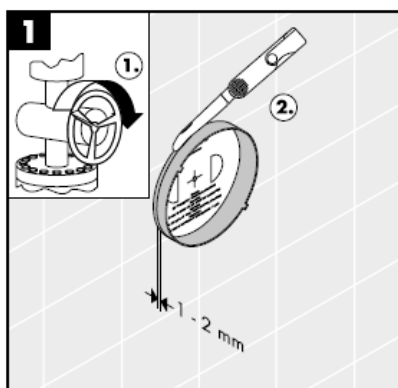

Silikon (ne sadrži kiseline)

Zahvaljujuću Safety funkciji može se podesiti željena maksimalna temperatura, npr. i 42 C

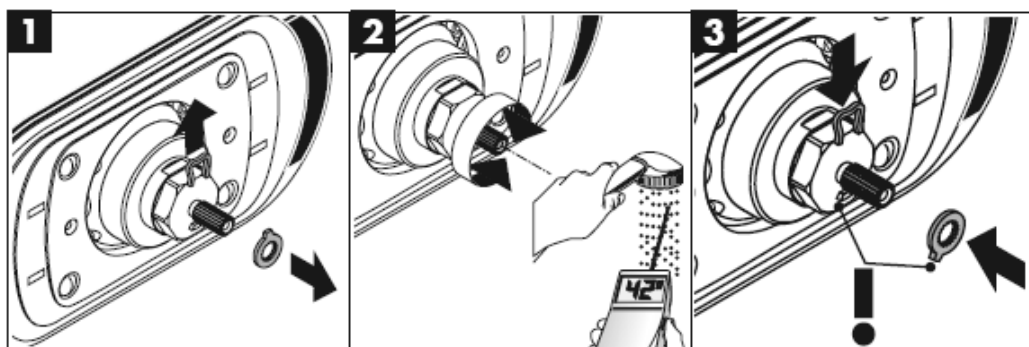

Regulacija

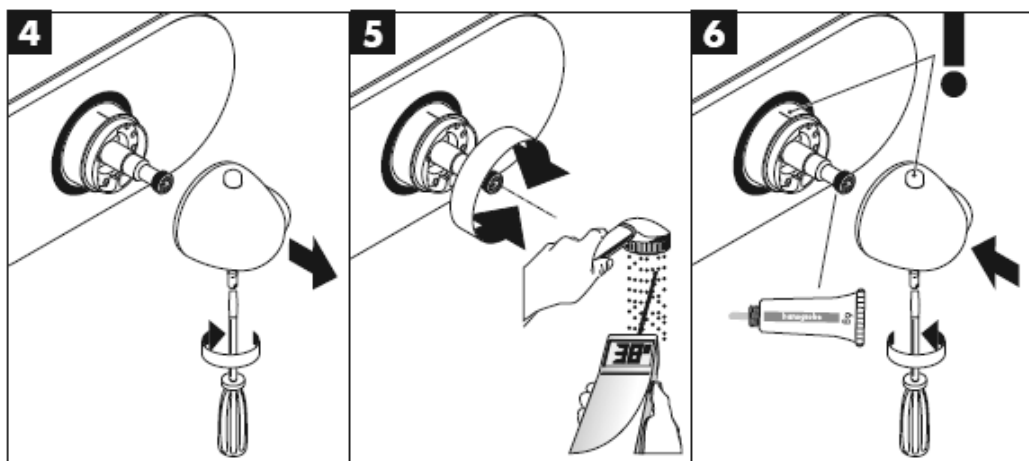



Tuš koji radi, zajedno sa nosačem tuša, težak je oko 10 kg. Zbog toga se smije koristiti samo materijal prikladan za pričvršćenje na postojeći zid! Priloženi vijci i moždanici prikladni su samo za masivne zidove.

Smijete koristiti jedino materijal prikladan za pričvršćivanje na vanjski zid. Priloženi vijci i tipla prikladni su samo za masivne zidove.

Potreban je optimalan protok vode

Optimalna funkcija zajamčena je samo u kombinaciji sa Hansgrohe High Flow termostatima

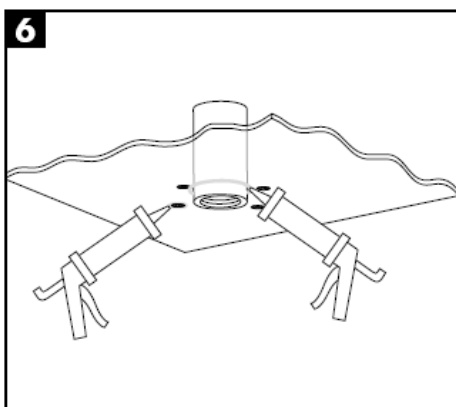
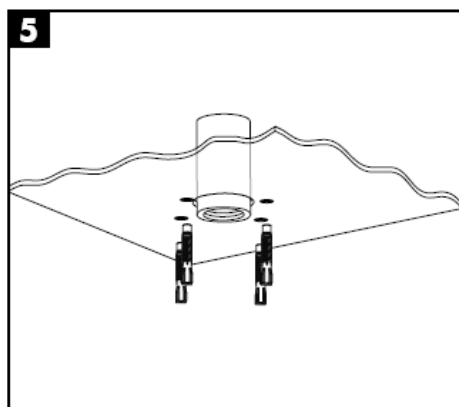
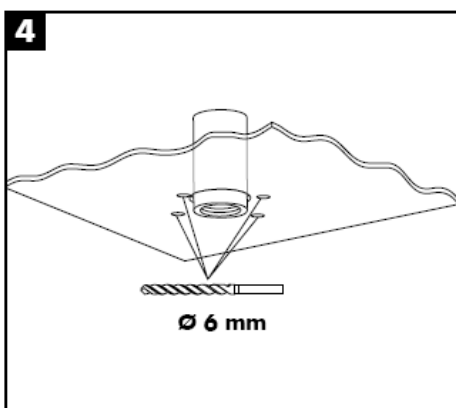
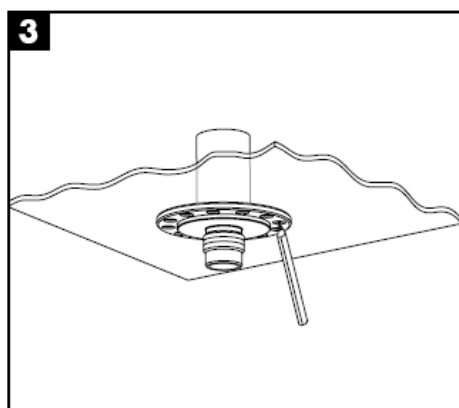
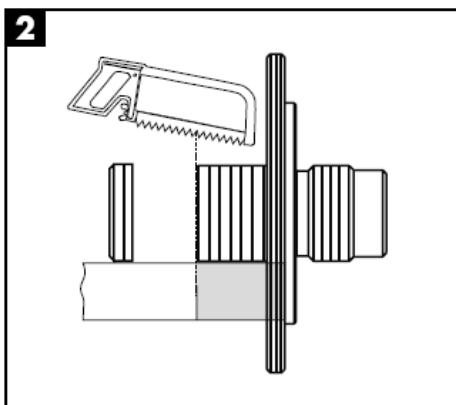
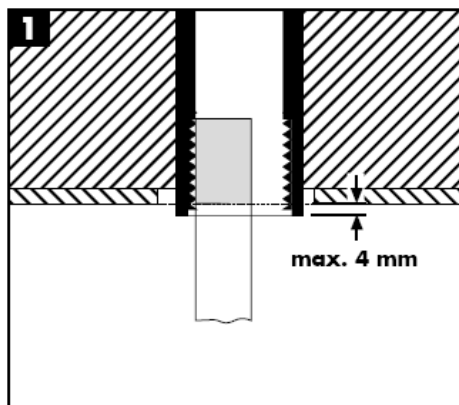

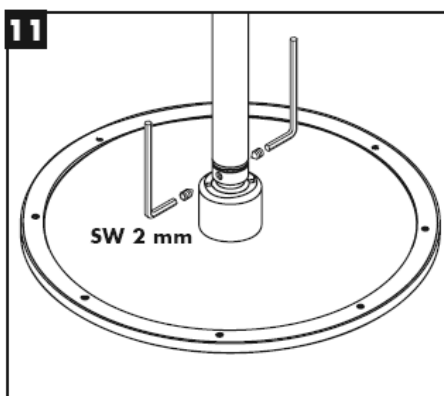
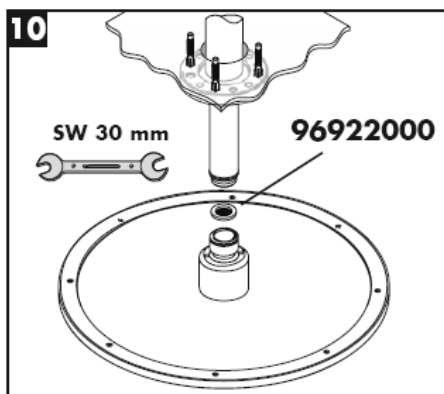
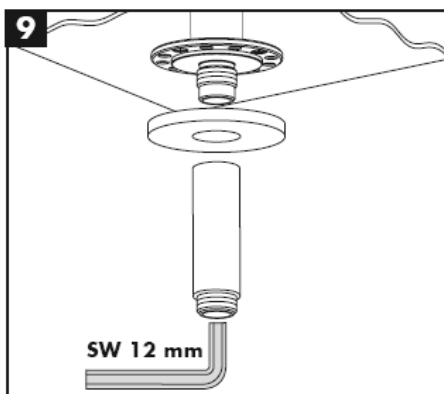
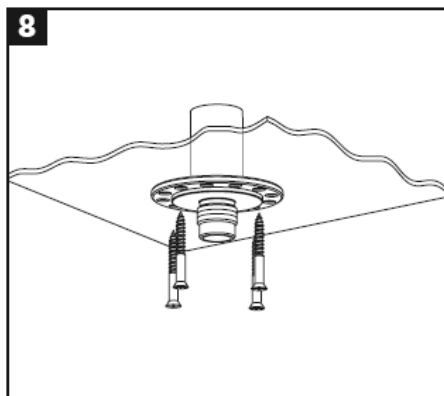
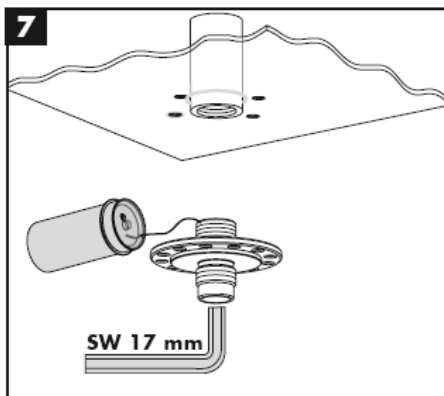

Filter potrebno je ugraditi kako bi se regulirao protok vode i smanjio dotok prljavštine. Za eventualna oštećenja uzrokovana prljavštinom proizvođač Hansgrohe nije odgovoran.

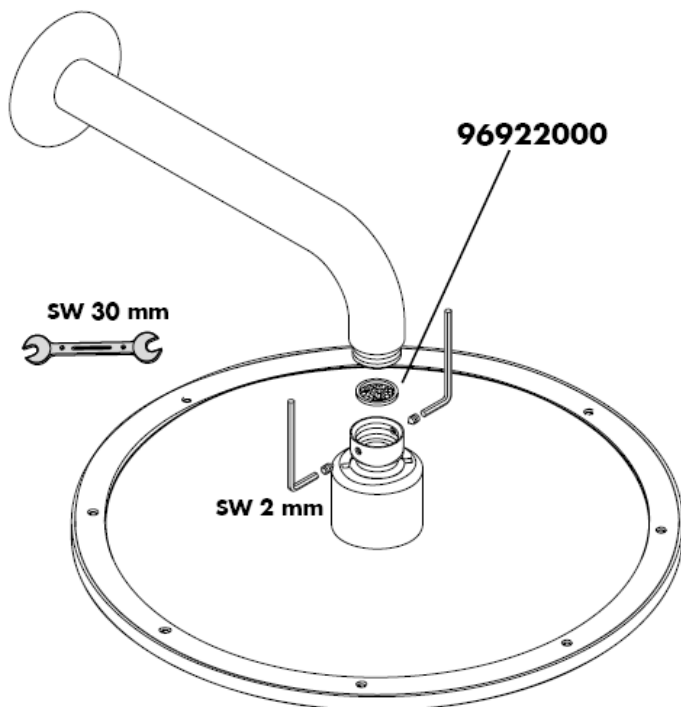

Sastavljanje

Pažnja! Cijevi moraju biti postavljene, isprane i testirane prema važećim normama!

Regulacija

Korekcija je potrebna ukoliko temperatura odstupa od one podešene na termostatu. Pritom pripazite na slijedeće: Okrenite skalu sve dok ne počne izlaziti voda temperature 38 °C. Odrvnite vijak ručice, povucite ručicu i okrenite je do pozicije 38 °C. Zatim ponovno natakните ručicu i pričvrstite vijak (vidi stranu 22)

Ograničenje temperature

Temperaturu možete ograničiti na 38 °C uz pomoć sigurnosnog sustava (zaštita od pare). Ukoliko želite temperaturu višu od 38 °C, pritiskom na gumb deaktivirate sigurnosni sustav

Safety Funkcija

Zahvaljujuću Safety funkciji može se podesiti željena maksimalna temperatura, npr. i 42 °C pogledaj stranicu 21.

Tehnički podatci

Najveći dopušteni tlak: max. 1 MPa
Preporučeni tlak: 0,1 – 0,5 MPa
Probni tlak: 1,6 MPa
(1 MPa = 10 bar = 147 PSI)
Temperatura vruće vode: max. 80 °C
Preporučena temperatura vruće vode: 65 °C
Protok vode: ca. 58 l/min 0,3 MPa

Održavanje

Nije potrebno posebno održavanje termostata. Ispravnost nepovratnog ventila mora se redovito provjeravati prema standardu DIN EN 1717 i u skladu sa važećim propisima (najmanje jednom godišnje). Također ispitajte ispravnost filtera za prljavštinu koji se nalazi na MTC regulacijskoj jedinici. (6.1) Nakon instalacije MTC regulacijske jedinice (6) obavezno ispitajte toplinu vode na slavini kao što je opisano pod točkom "Regulacija". No prije toga svakako ispitajte je li uključen sustav za opskrbu toplom vodom i izlazi li na probnom mjestu voda s maksimalnom temperaturom u odnosu na dispoziciju

Kako bi se olakšala prohodnost i produljio vijek trajanja regulacijske jedinice, potrebno je s vremena na vrijeme podesiti termostat iz položaja maksimalno tople u položaj maksimalno hladne vode.

Rezervni djelovi pogledaj stranicu 3

1	Ručica termostata	38391000
2	Rozete	96452000
3	Čahura	97439000
4	Vijak nosača	96454000
5	Rozeta nosača	96447000
6	Sustav za regulaciju temperature	96633000
7	Rešetkasti filter	97367000
8	nepovratni ventil	96655000
9	Produljenje 25 mm	13595000
10	Produljenje 25 mm	13596000

Hrvatski

Greška	Uzrok	Otklanjanje
Nedovoljno vode	-Prenizak pritisak vode -Očistite rešetkasti filter regulacijske jedinice -Filter tuša je prljav	-Ispitajte tlak u cijevima -Očistite rešetkasti filter ispred termostata i na regulacijskoj jedinici -Očistite filter između tuša i crijeva
Križni tok vode, kod zatvorene armature vruća voda ulazi u cijev s hladnom vodom i obrnuto	-Nepovratni ventil je prljav/neispravan	-Zamijenite nepovratni ventil
Temperatura na slavini ne podudara se s podešenom temperaturom	-Termostat nije podešen -Preniska temperatura tople vode	-Podesite termostat -Povećajte tempereturu vruće vode na 42-65 C
Reguliranje temperature nije moguće	-Regulator temperature je prljav ili obložen naslagama kamenca -Unutarnji blok okrenite za 180 stupnjeva	-Pri ponovnoj instalaciji tijelo je pogrešno priključeno (potrebno je priključiti hladnu vodu desno, a vruću lijevo) ili je zakrenuto za 180 stupnjeva. -Tipkalo sigurnosnog prekida je van funkcije
Opruga je neispravna	-Očistite i podmažite oprugu, tj. tipkalo, u slučaju potrebe tipkalo možete zamijeniti novim -Tipkalo je začepljeno slojem kamenca	-Očistite i podmažite oprugu, tj. tipkalo, u slučaju potrebe tipkalo možete zamijeniti novim -Očistite i podmažite oprugu, tj. tipkalo, u slučaju potrebe tipkalo možete zamijeniti novim

Oznaka testiranja

	P-IX	DVGW	SVGW	WRSA	KIWA	ACS	NF
27070000						X	
27418XXX							
28420000						X	
28435XXX						X	

Čišćenje

Jednostavno čisto: Kamenac se sasvim lako uklanja s izbočina.

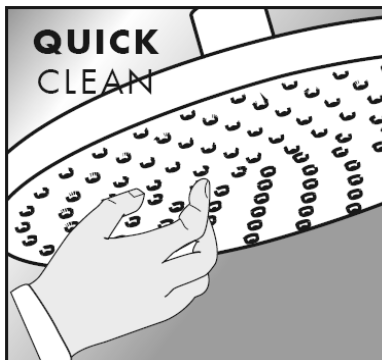

Uputstva za održavanje i čišćenje

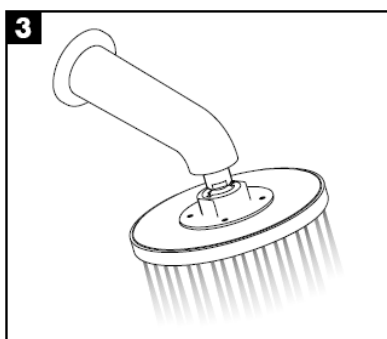
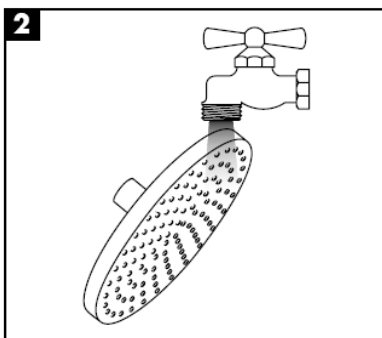
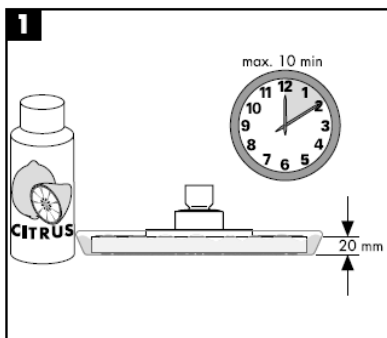

hansgrohe

Hansgrohe · Postfach 1145 · D-77761 Schiltach · Telefon +49 (0) 78 36/51-1282 · Telefax +49 (0) 7836/511440
E-Mail: info@hansgrohe.com · Internet: www.hansgrohe.com

07/2008
9.05170.04
Hrvatski

Montaj kılavuzu



27418XXX

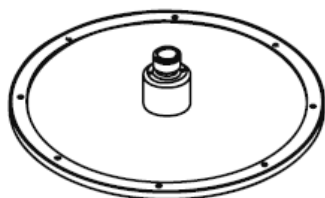

Raindance Royale AIR
28420000

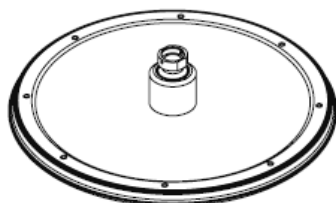

Raindance Royale Classic AIR
28435XXX

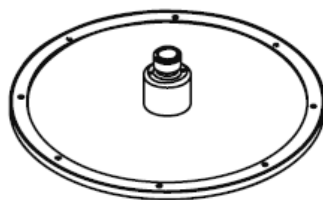

**Raindance Royale
High Flow Set**
27070000

hansgrohe

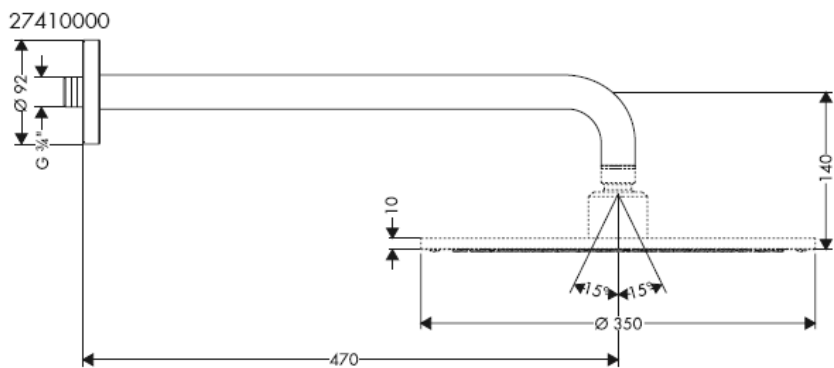
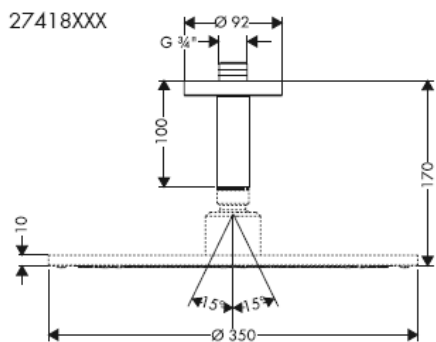
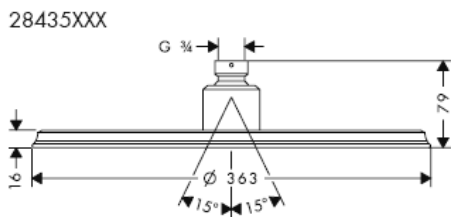
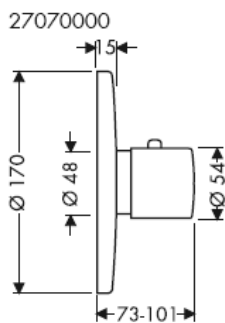
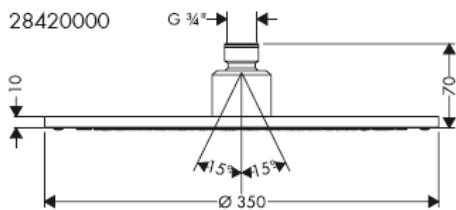

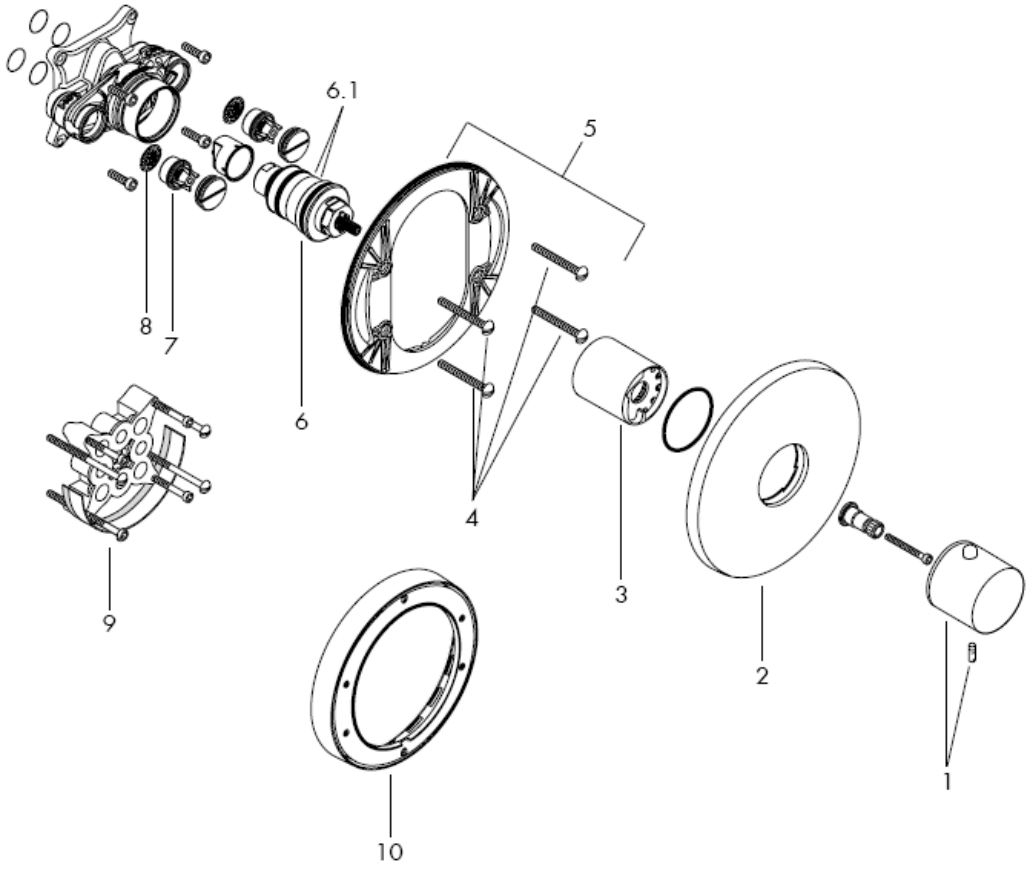

Boyutları olabildiği kadar fayans tipine uyarlayın.

Duř kolu sabitlemesi için duvar takviyesi gereklidir

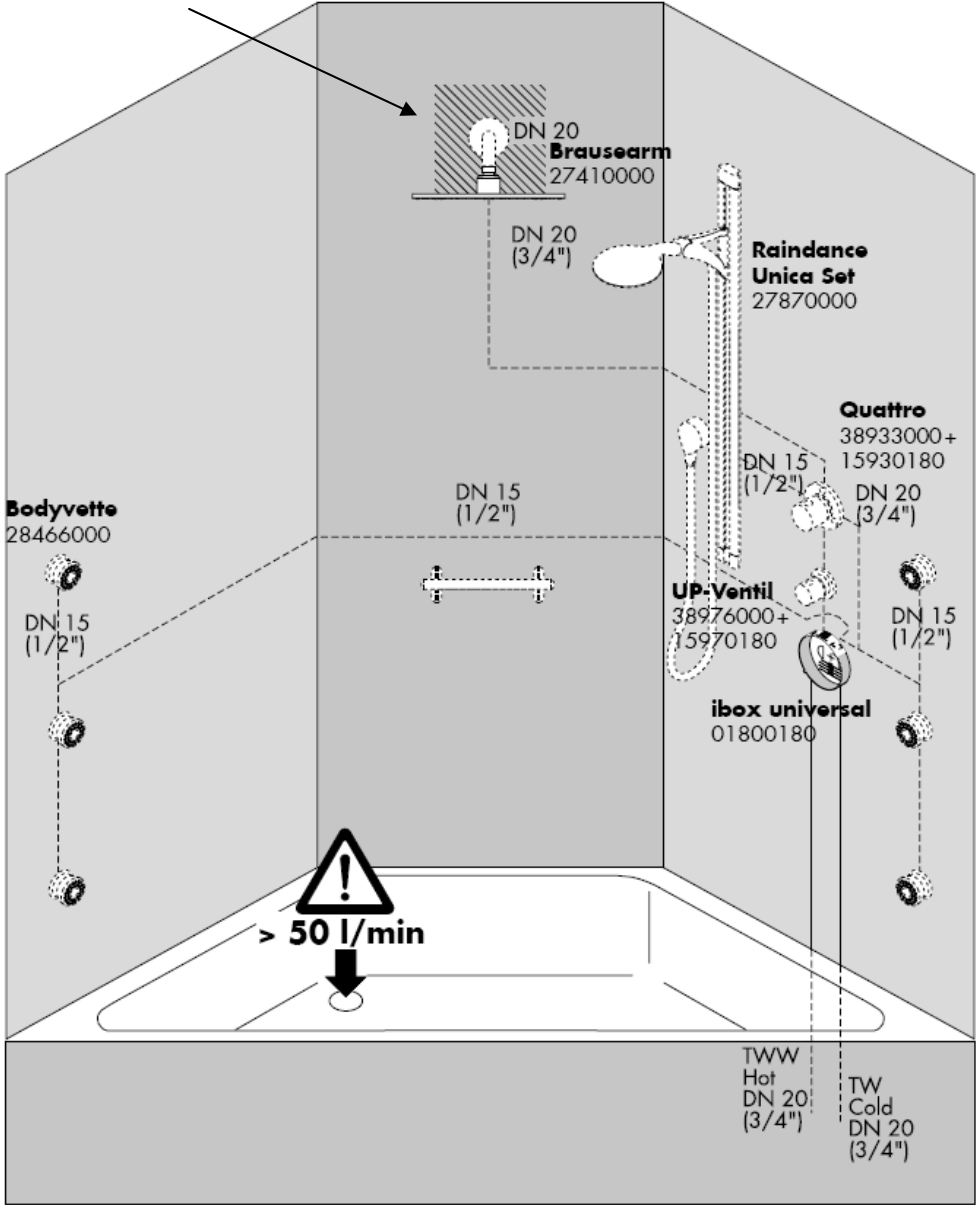

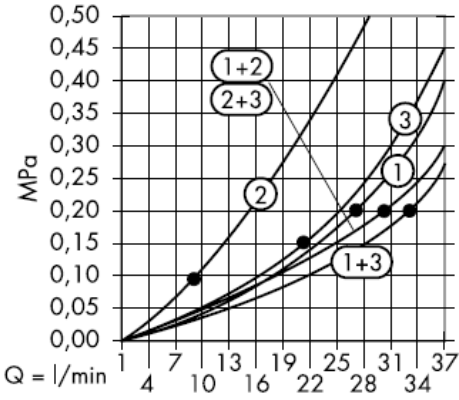

•den itibaren fonksiyon garanti edilmiştir.

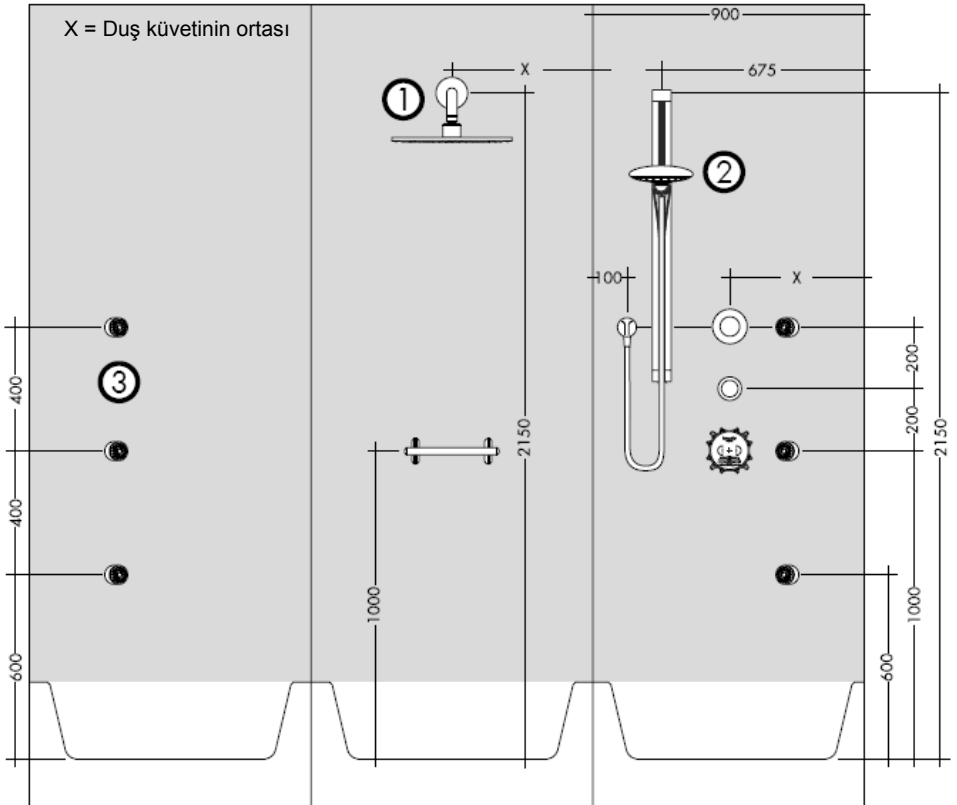

Duř kolu sabitlemesi için duvar takviyesi gereklidir

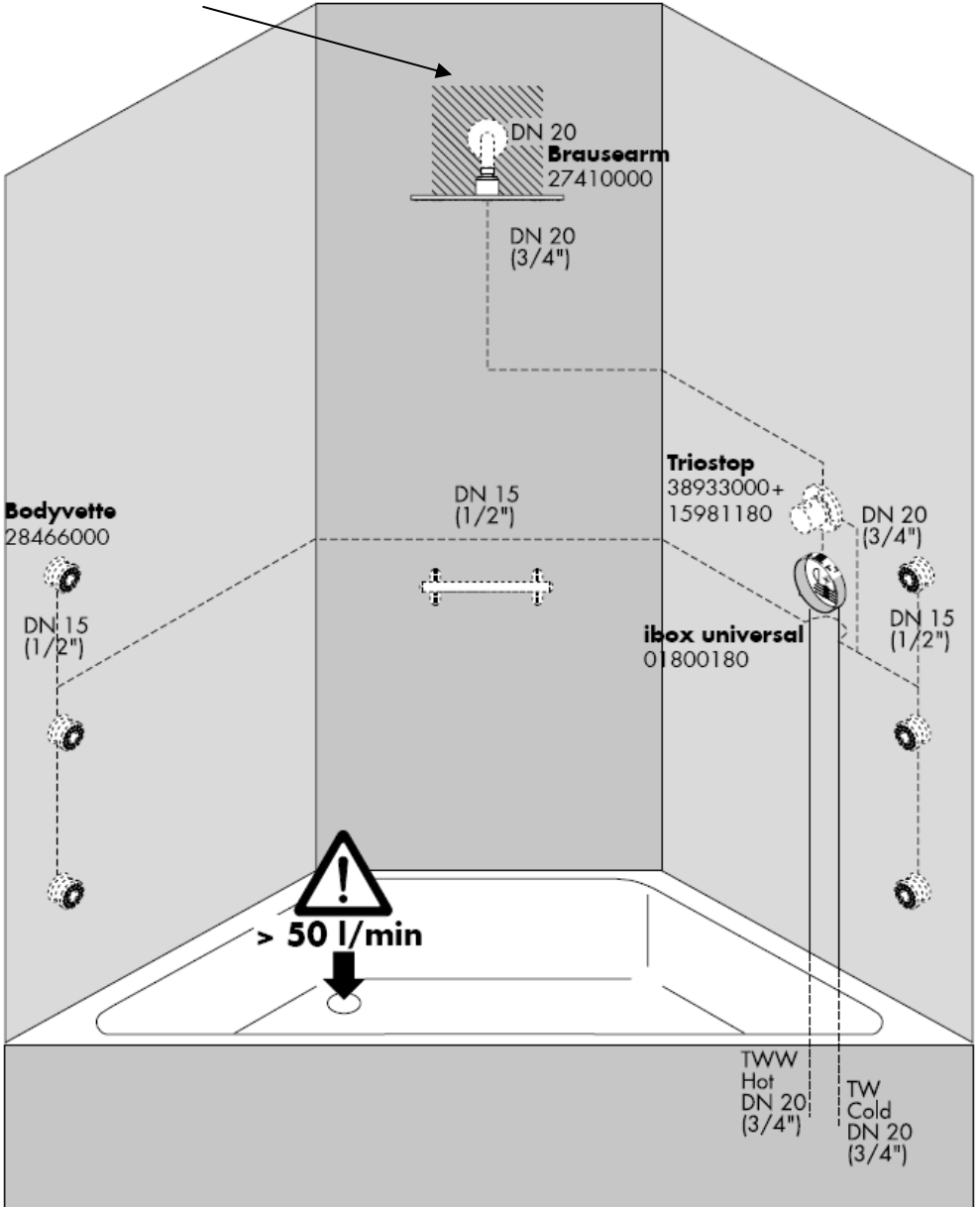

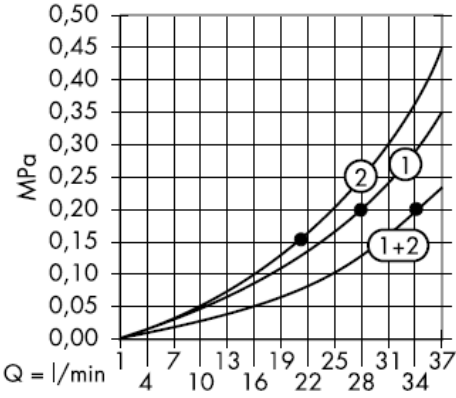

•den itibaren fonksiyon garanti edilmiştir.

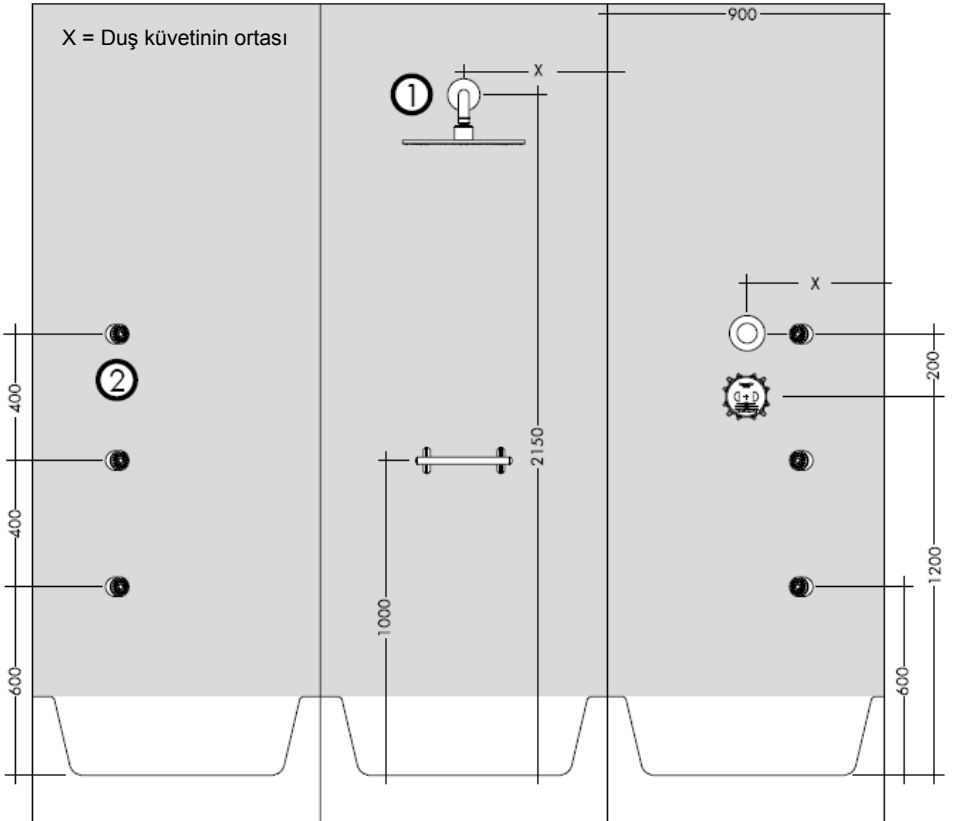

Duř kolu sabitlemesi için duvar takviyesi gereklidir

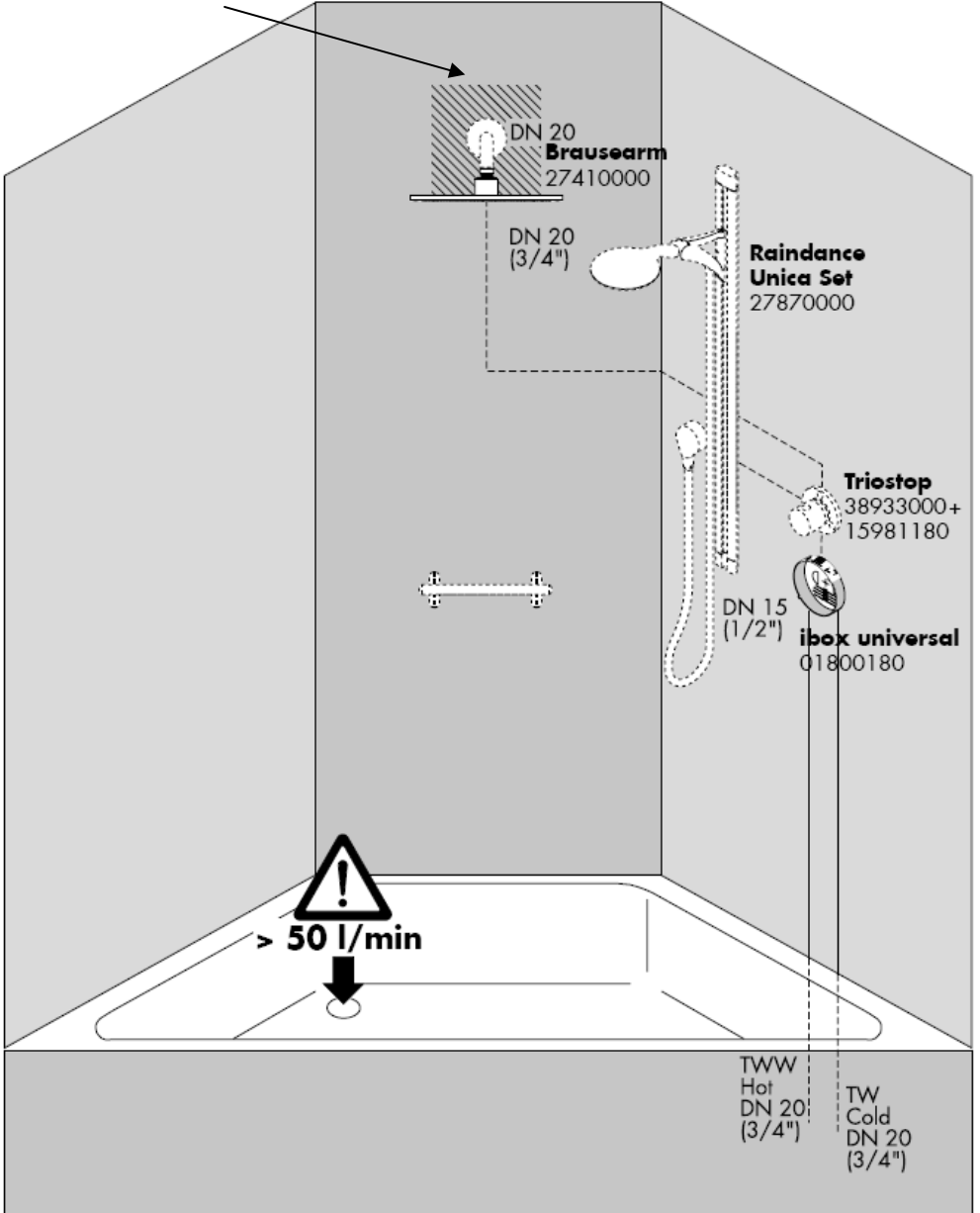

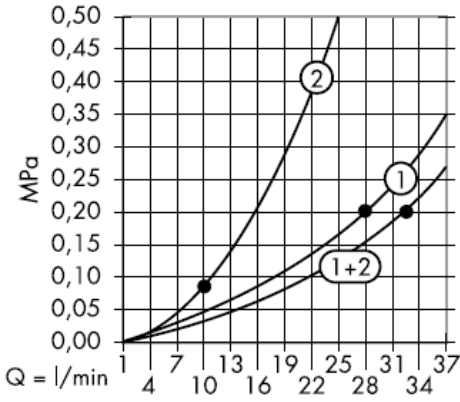

•den itibaren fonksiyon garanti edilmiştir.

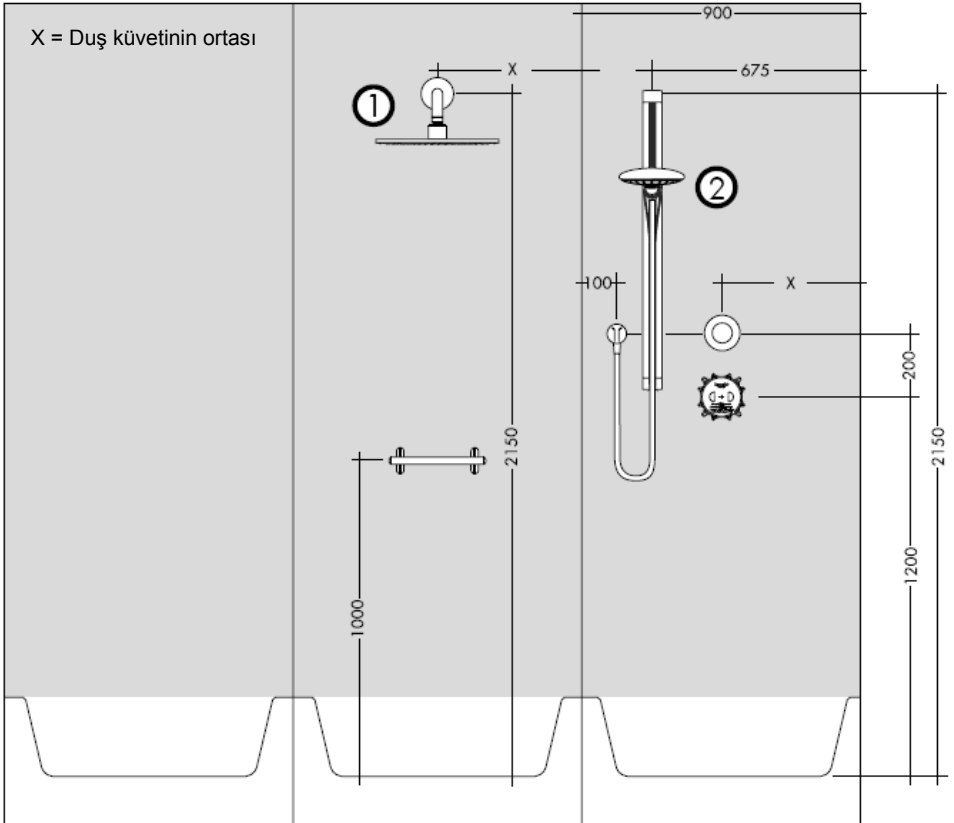

Duř kolu sabitlemesi için duvar takviyesi gereklidir

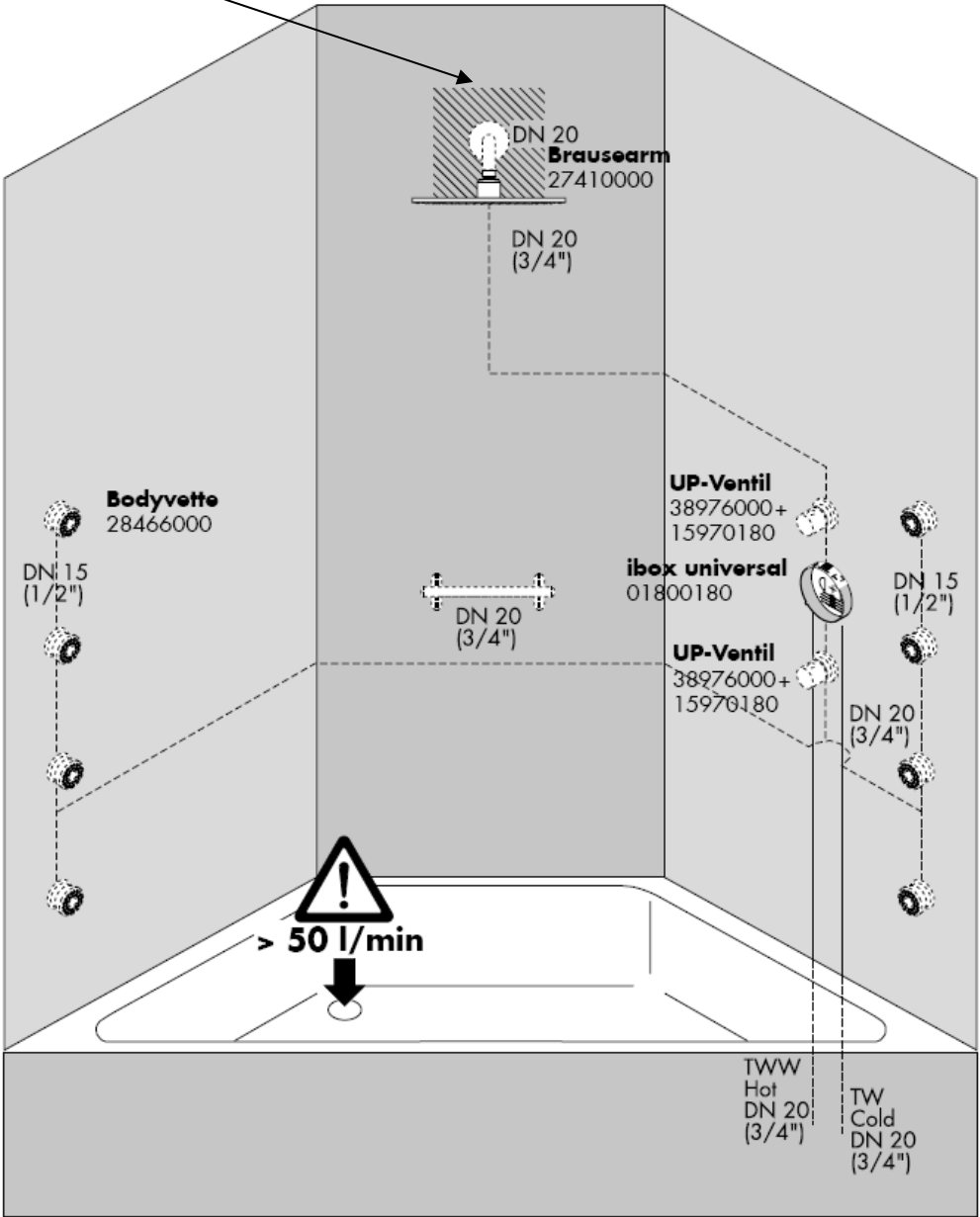

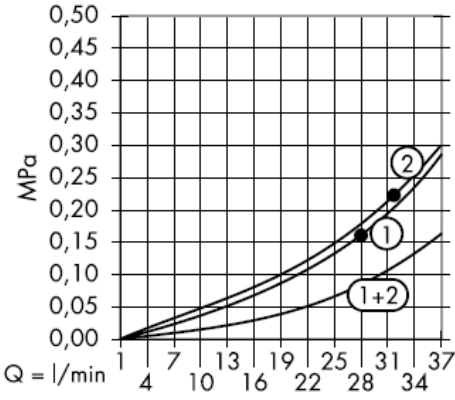

•den itibaren fonksiyon garanti edilmiştir.

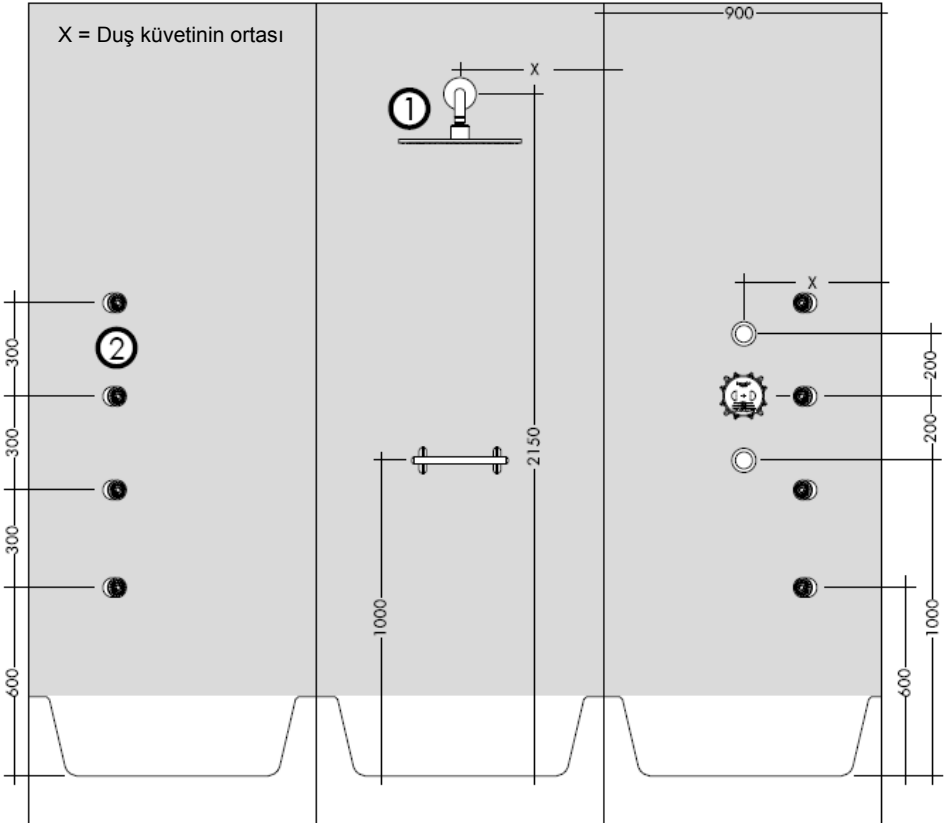

Duř kolu sabitlemesi için duvar takviyesi gereklidir

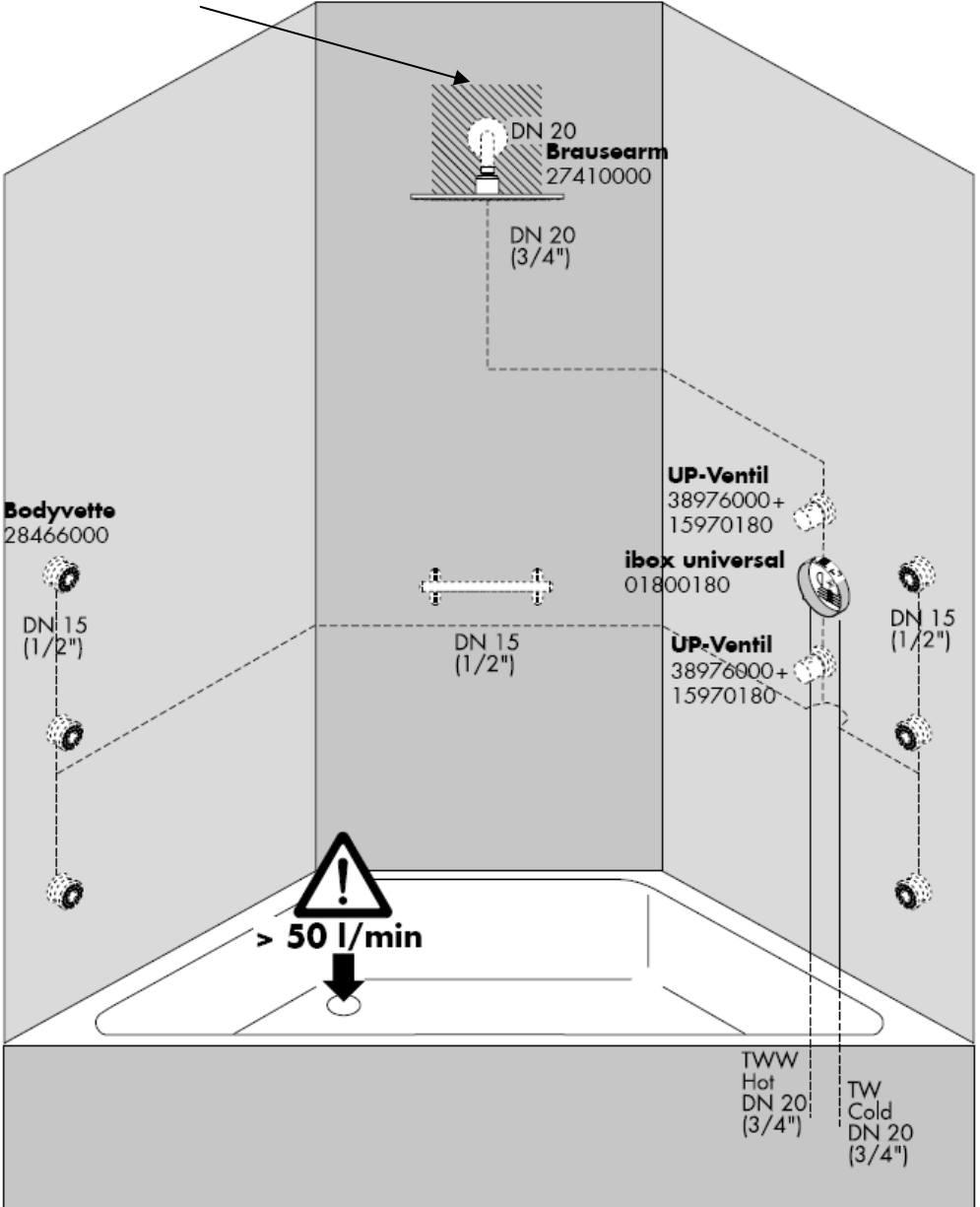

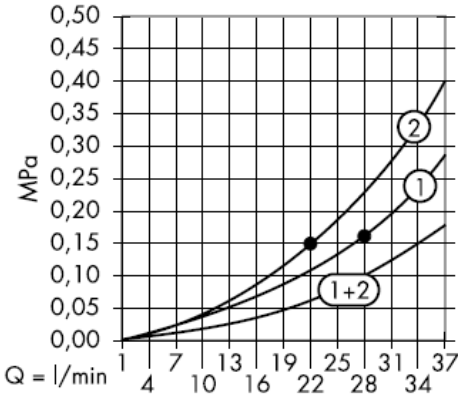

•den itibaren fonksiyon garanti edilmiştir.

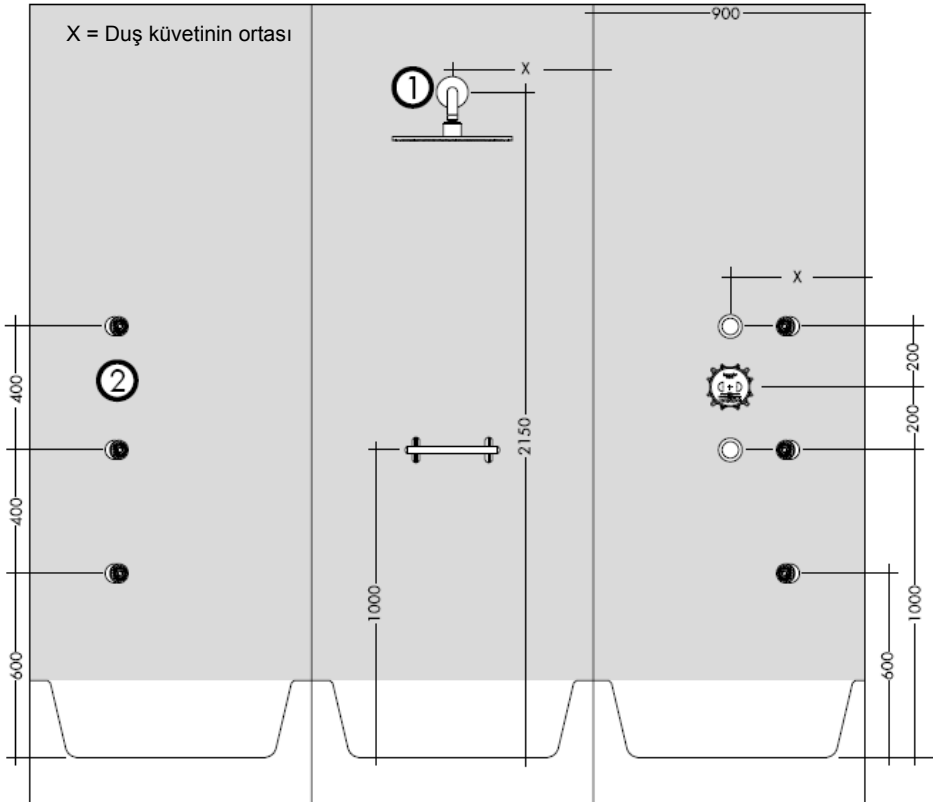

Duř kolu sabitlemesi için duvar takviyesi gereklidir

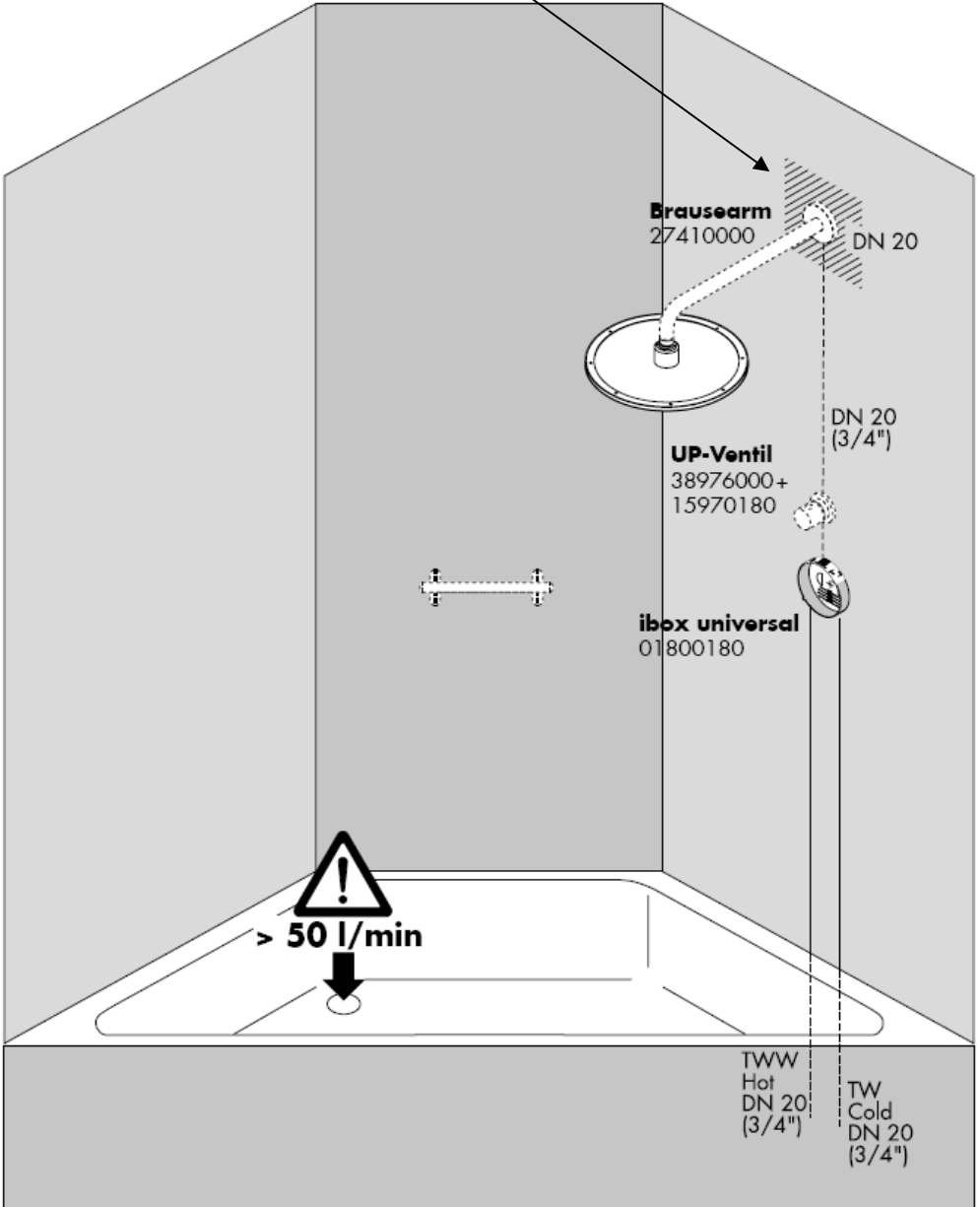

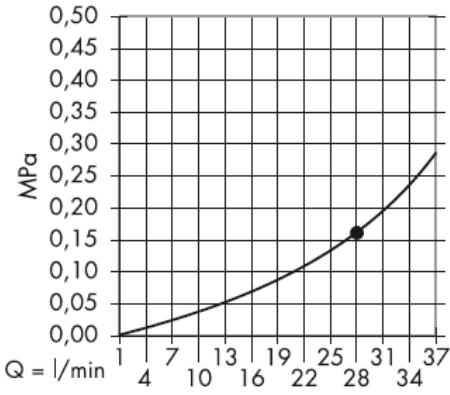

•den itibaren fonksiyon garanti edilmiştir.

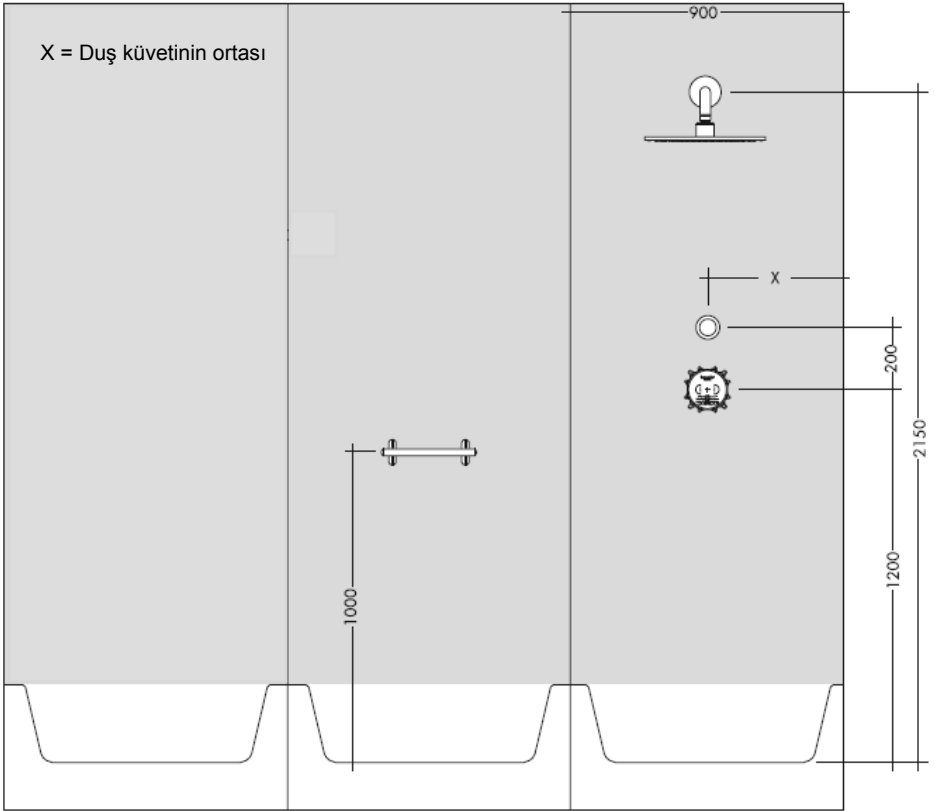

Duř kolu sabitlemesi için duvar takviyesi gereklidir

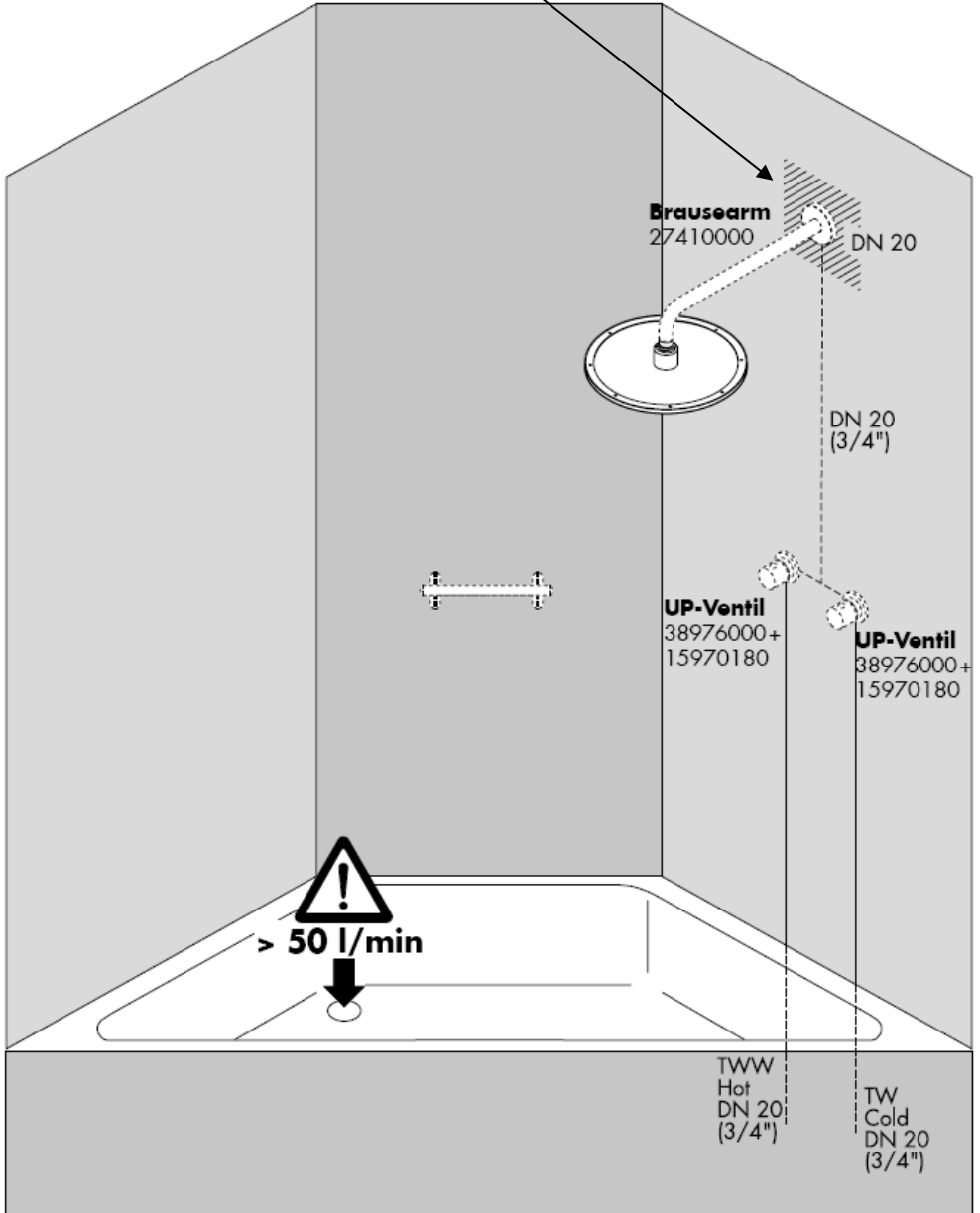

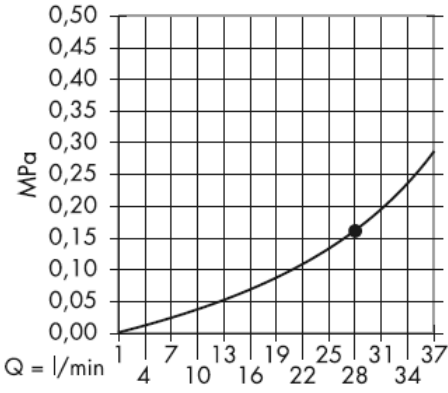

•den itibaren fonksiyon garanti edilmiştir.

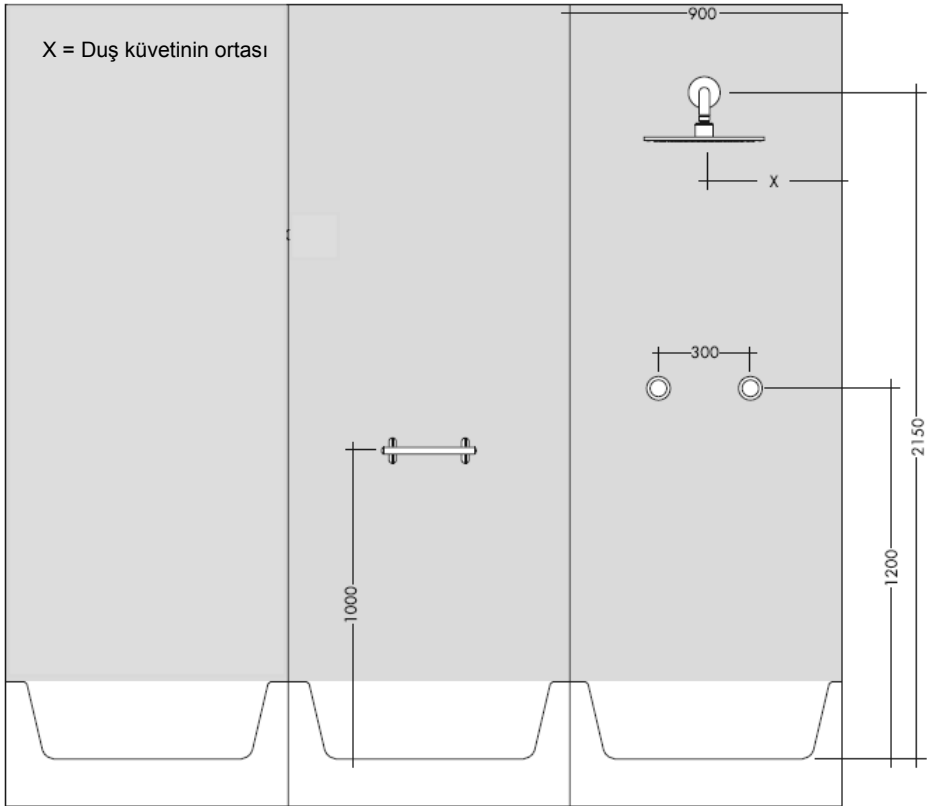

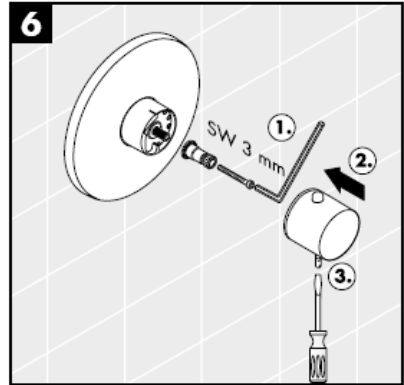
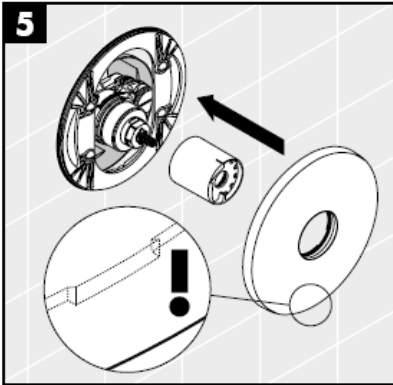
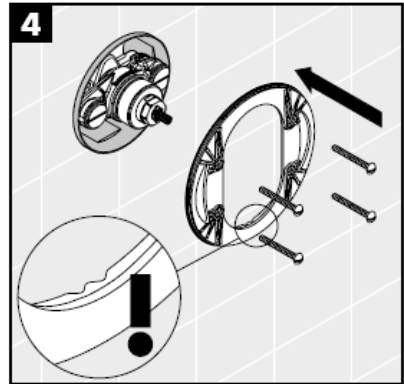
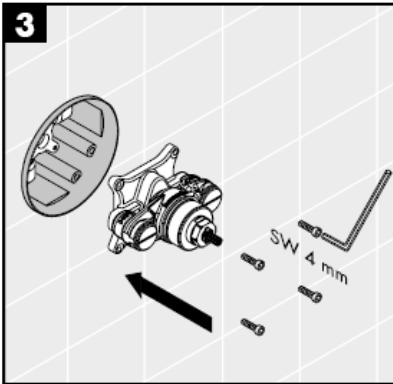
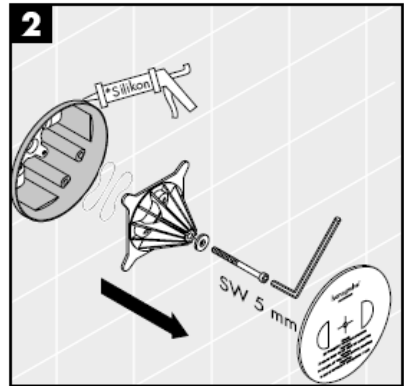
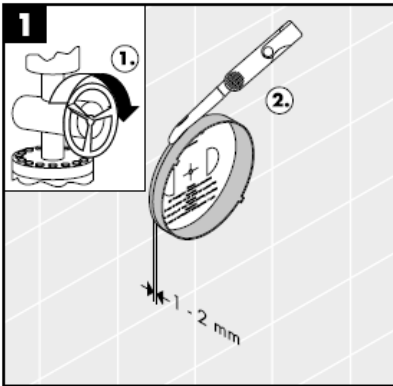

Silikon (asetik asit içermeyen)

Emniyet fonksiyonu sayesinde, istenen maksimum sıcaklık Örn; maks. 42 C önceden ayarlanabilir.

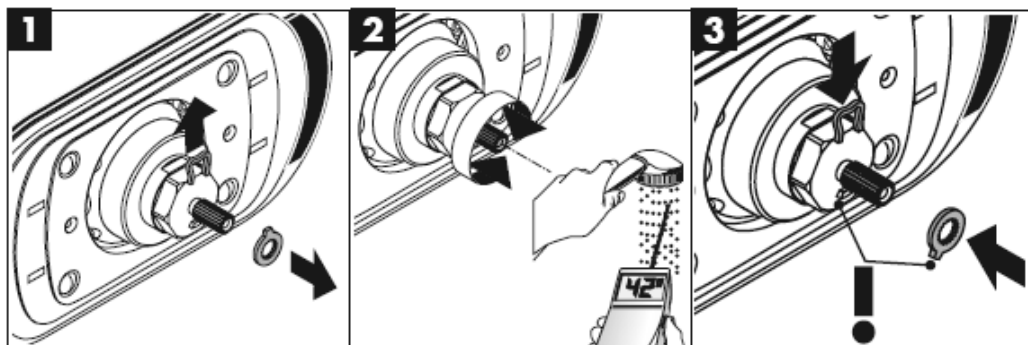

Ayarlama

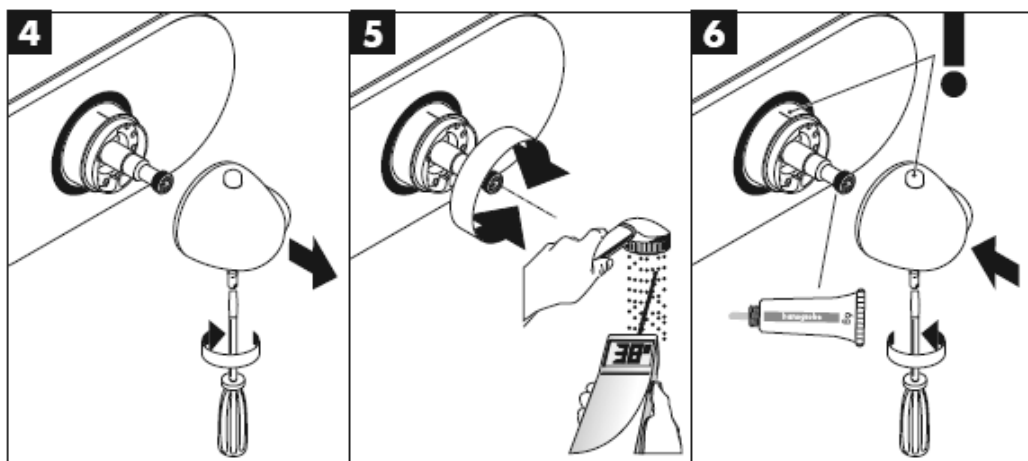



Su püskürtücü çalışıyorsa, su püskürtücü koluyla birlikte yakl. 10 kilo ağırlığındadır. Bu nedenle yalnızca duvar için uygun olan sabitleme malzemesi kullanılmalıdır! Birlikte verilen vida ve dübeller yalnızca masif duvarlar içindir.

Sadece duvarlar için uygun olan sabitleme malzemesi kullanılmalıdır! Ekteki civatalar ve dübeller sadece masif duvarlar içindir.

Çıkış kapasitesi yeterli miktarda boyutlandırılmış olmalıdır.

Optimum fonksiyon sadece Hansgrohe High Flow termostatları ile bağlantılı olarak garanti edilir.

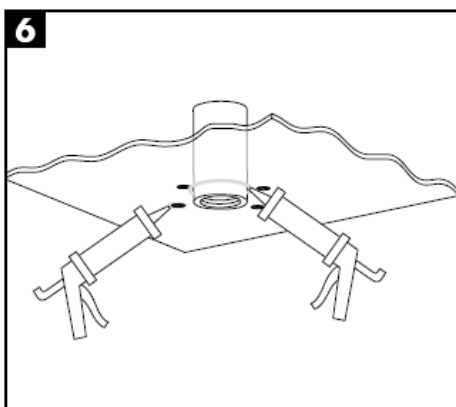
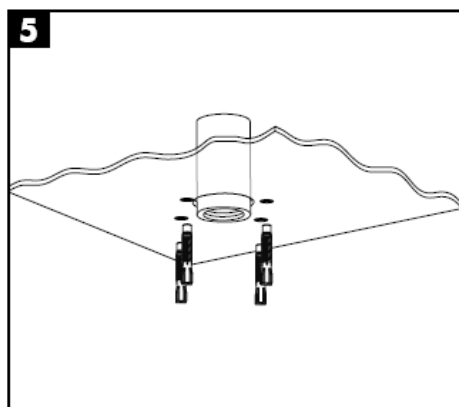
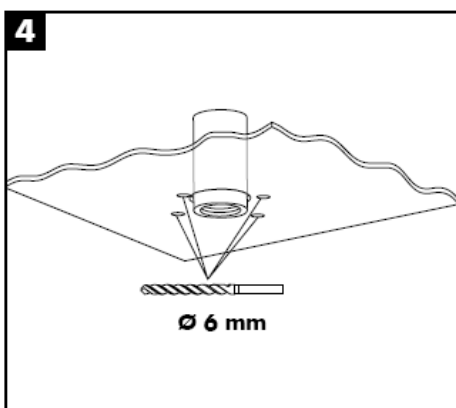
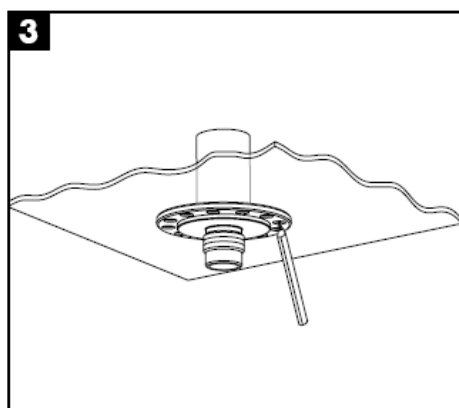
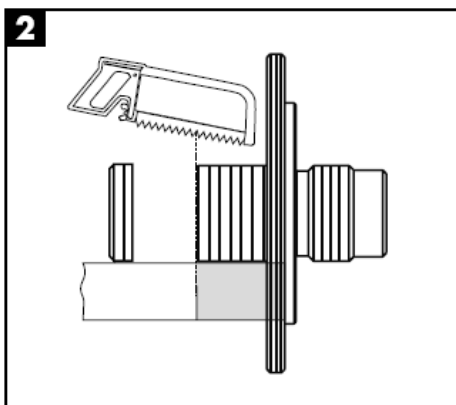
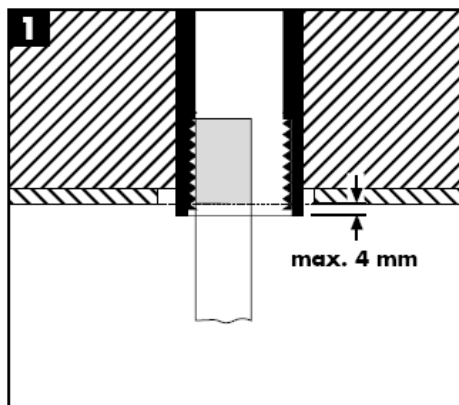

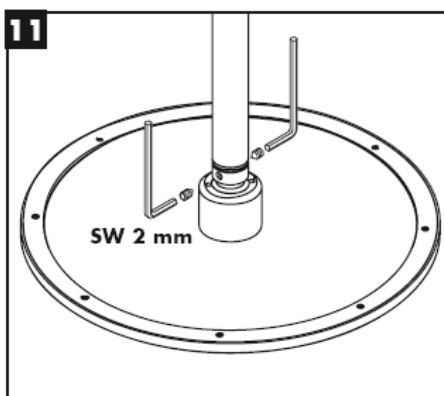
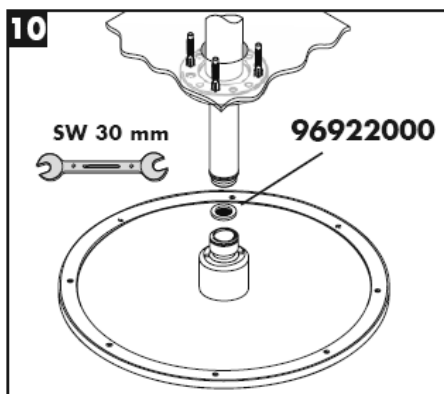
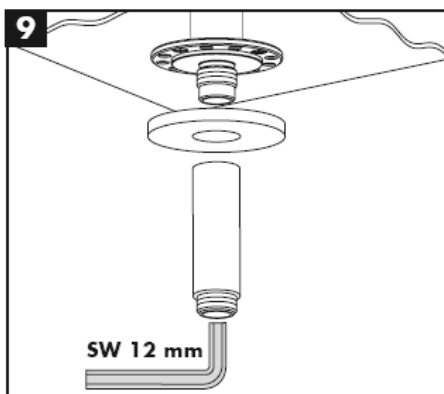
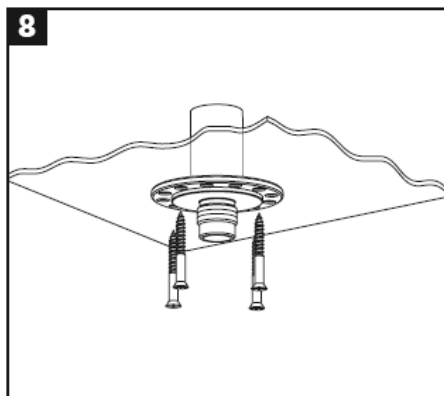
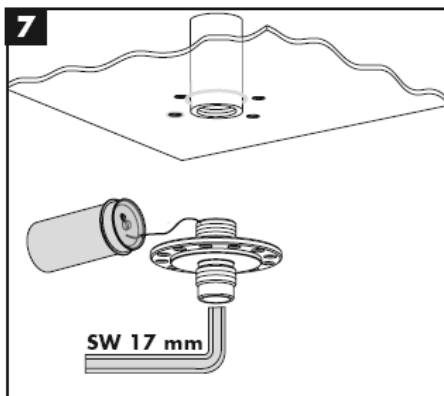

El duşu kafasına eklenmiş olan süzgeç contası, boru şebekesinden sızan kirlerin önüne geçmek için, yerine monte edilmelidir. İçeri sızan bu kirler duşun fonksiyonunu sekteleyebilir ve/veya duşun fonksiyon parçaları üzerinde hasarlara sebep olabilir, bu yüzden meydana gelen hasarlardan Hansgrohe sorumlu tutulamaz.

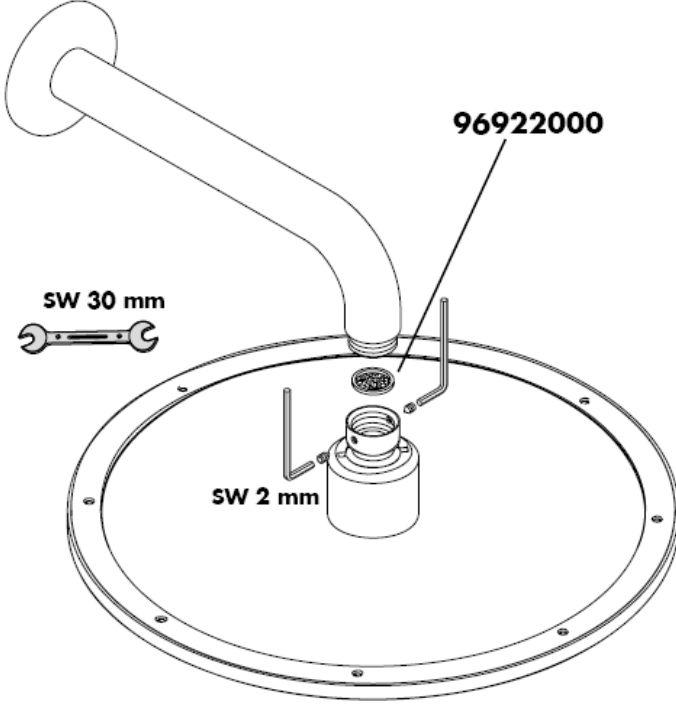

Montajı

Önemli! Batarya geçerli normlara göre monte edilmeli, yıkanmalı ve kontrol edilmelidir!

Ayarlama

Alma noktasında ölçülen sıcaklık termostatta ayarlanan sıcaklıktan farklıysa, bir düzeltme gereklidir. Bu sırada şunlara dikkat edilmelidir: Alma noktasından 38 C su çıkana kadar ölçekli kumanda kolunu döndürün. kumanda kolu vidasını gevşetin, kumanda kolunu geri çekin ve 38 C konumuna kadar döndürün. kumanda kolunu takın ve kumanda kolu vidasını sıkın (Bkz. Sayfa 22).

Sıcaklık sınırlama

Sıcaklık aralığı, emniyet kilidi ile 38 C de sınırlanır (haşlanma koruması). Daha yüksek bir sıcaklık istenirse, emniyet düğmesine basarak 38 engeli aşılabılır.

Safety Function

Emniyet fonksiyonu sayesinde, istenen maksimum sıcaklık Örn; maks. 42 C önceden ayarlanabilir. Bakınız sayfa 21.

Teknik bilgiler

İşletme basıncı: max. 1 MPa
Tavsiye edilen işletme basıncı: 0,1 – 0,5 MPa
Kontrol basıncı: 1,6 MPa
(1 MPa = 10 bar = 147 PSI)
Sıcak su sıcaklığı: max.80° C
Tavsiye edilen su ısısı: 65° C
Debisi : ca.58 l/min 0,3 MPa

Bakım

Termostatlar özel bir bakım gerektirmez DIN EN 1717 ve ulusal standartlar doğrultusunda Çek valfler düzenli olarak kontrol edilmelidir. (en az yılda bir kez) Bu fırsatı kullanarak, MTC ayar ünitesinde (6.1) bulunan kir tutucuları da kontrol edin. MTC ayar ünitesini (6) taktıktan sonra, "Ayarlama" maddesinde tarif edildiği gibi çıkış sıcaklığını da mutlaka kontrol edin. Daha önce, muylu noktasında sıcak su beslemesi ve maksimum sıcak su sıcaklığının mevcut olup olmadığını da mutlaka kontrol edin.

Ayar ünitesinin kolay hareket etmesini sağlamak için, termostat belirli aralıklarla tamamen sıcak ve soğuk konuma getirilmelidir.

Yedek Parçalar Bakınız sayfa 3

1	Termostat kolu	38391000
2	Yedek parça	96452000
3	Kovan	97439000
4	Taşıyıcı vidalar	96454000
5	Taşıyıcı rozet	96447000
6	Sıcaklık ayar ünitesi	96633000
7	Filtre	97367000
8	Çek valf	96655000
9	Uzatma 25 mm	13595000
10	Uzatma 25 mm	13596000

Türkçe

arıza	sebeup	yardıım
Az su geliyor	-Besleme basıncı yeterli deęil -Ayar ünitesinin filtresi kirlenmiř -Duřun süzgeci tıkanmıř olabilir	-Hat basıncını kontrol edin -Filtreleri temizleyin -El duřu ile hortum arasındaki hortumu yıkayın
Çapraz akıř, batarya kapalıyken sıcak su soęuk su hattına gönderiliyor ya da tam tersi	-Çek valf kirlenmiř / arızalı	-Çek valfi deęiřtirin
Çıkıř sıcaklıęı ayarlanan sıcaklıkla aynı deęil	-Termostat ayarlanmadı -Sıcak suyun derecesi çok düřük	-Termostatı ayarlayın -Sıcak su sıcaklıęını 42 C ila 65 C'ye yükseltin
Sıcaklık ayarı mümkün deęil	-Sıcaklık ayar ünitesi kirlenmiř ya da kireçlenmiř -Fonksiyon bloęunu 180 döndürerek takın	-Yeni montaj sırasında ana gövde yanlış bağlanmıř (Olması gereken: soęuk saę tarafa, sıcak sol tarafa) ya da 180 döndürülerek takılmıř -Emniyet kilidinin düęmesi çalışmıyor
Yay arızalı	-Yayı ya da düęmeyi temizleyin ve hafifçe gres sürün, gerekirse deęiřtirin -Düęme kireçlenmiř	-Yayı ya da düęmeyi temizleyin ve hafifçe gres sürün, gerekirse deęiřtirin -Yayı ya da düęmeyi temizleyin ve hafifçe gres sürün, gerekirse deęiřtirin

Kontrol iřareti

	P-IX	DVGW	SVGW	WRSA	KIWA	ACS	NF
27070000						X	
27418XXX							
28420000						X	
28435XXX						X	

Temizleme

Sadece temiz: Kireç, düğümlerle kolayca ovalanabilir.

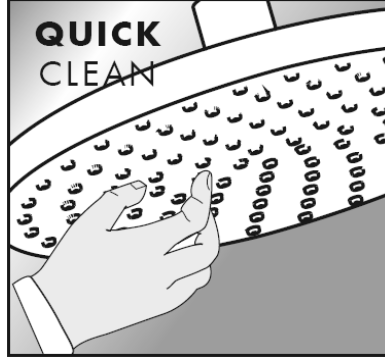

Bakım kılavuzu

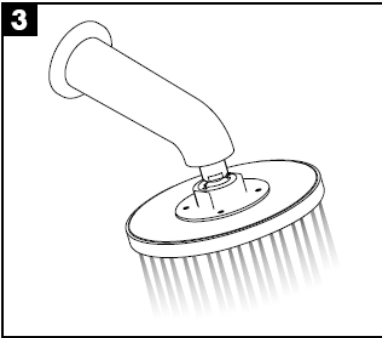
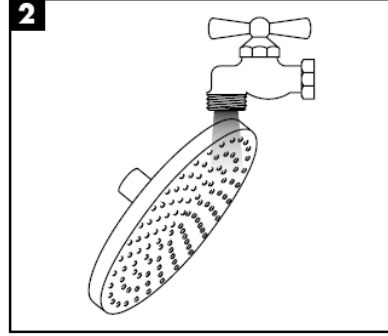
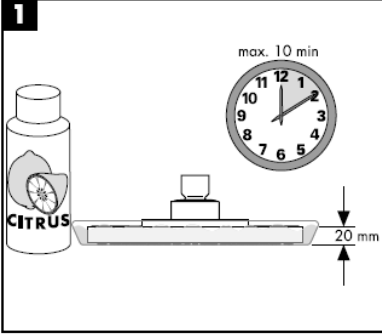

hansgrohe

Instrucțiuni de montare



27418XXX

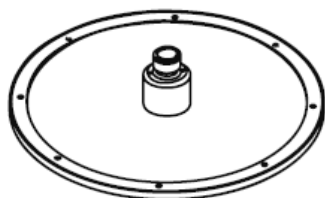

Raindance Royale AIR
28420000

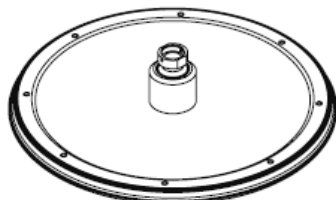

Raindance Royale Classic AIR
28435XXX

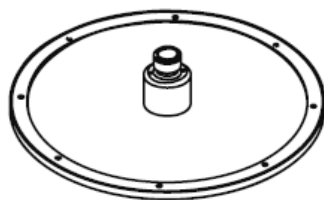

**Raindance Royale
High Flow Set**
27070000

hansgrohe

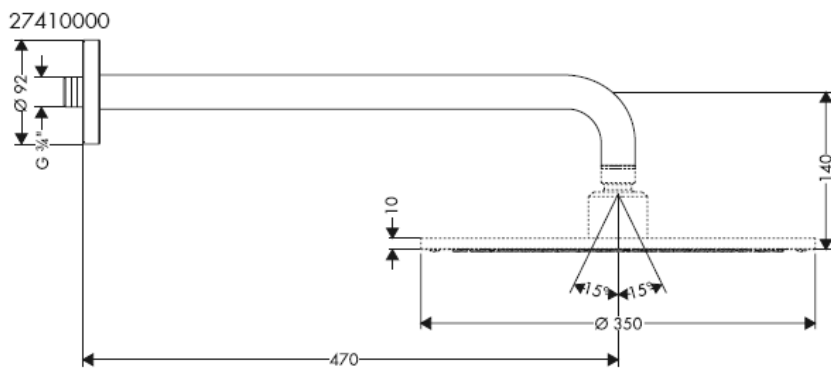
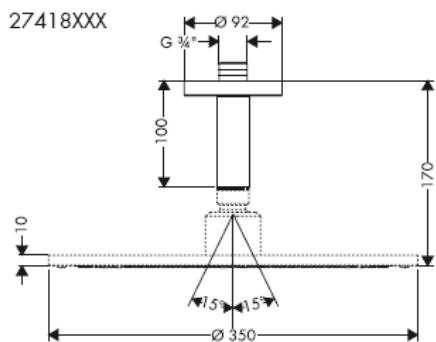
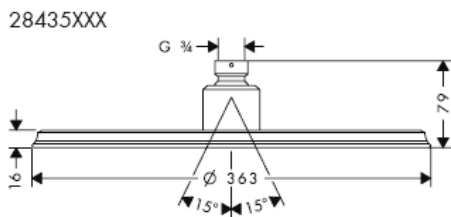
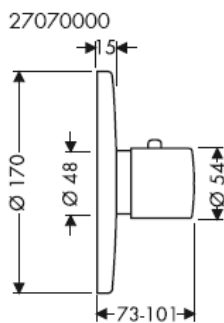
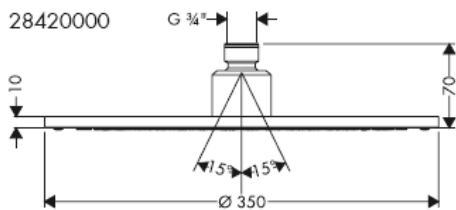

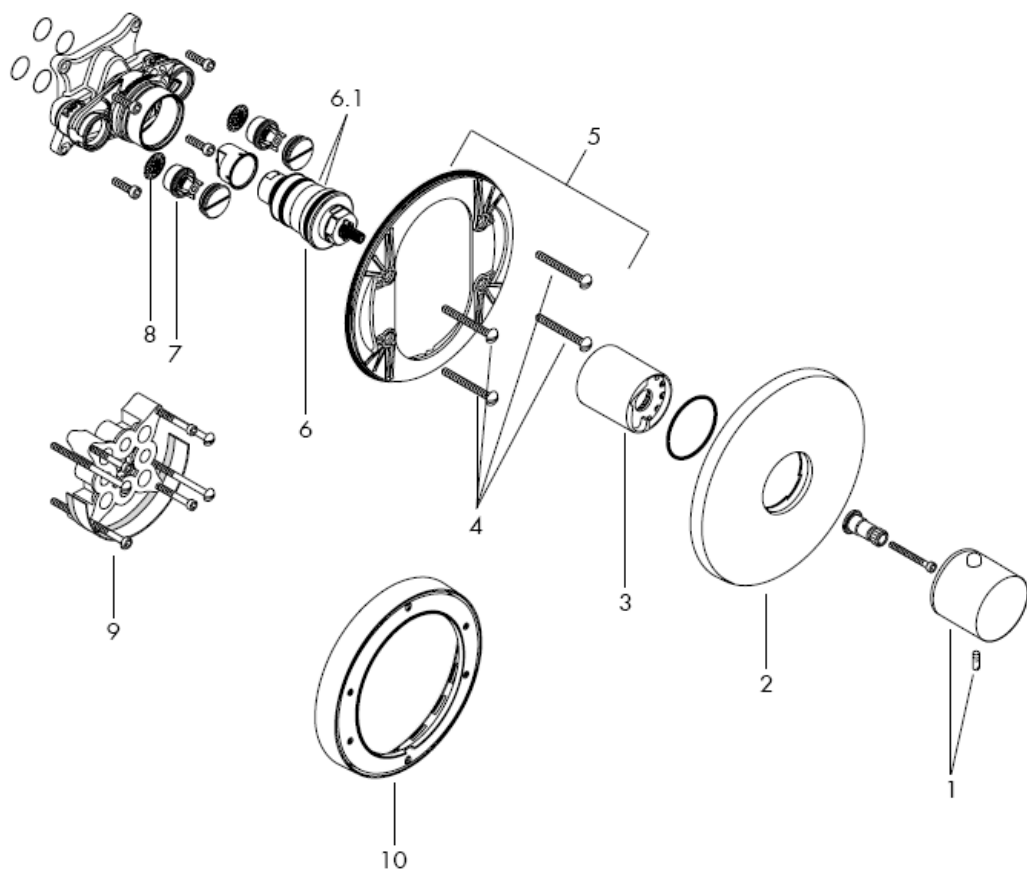

Reglați dimensiunile la suprafața tencuielii.

Pentru fixarea brațului dușului este necesară consolidarea peretelui

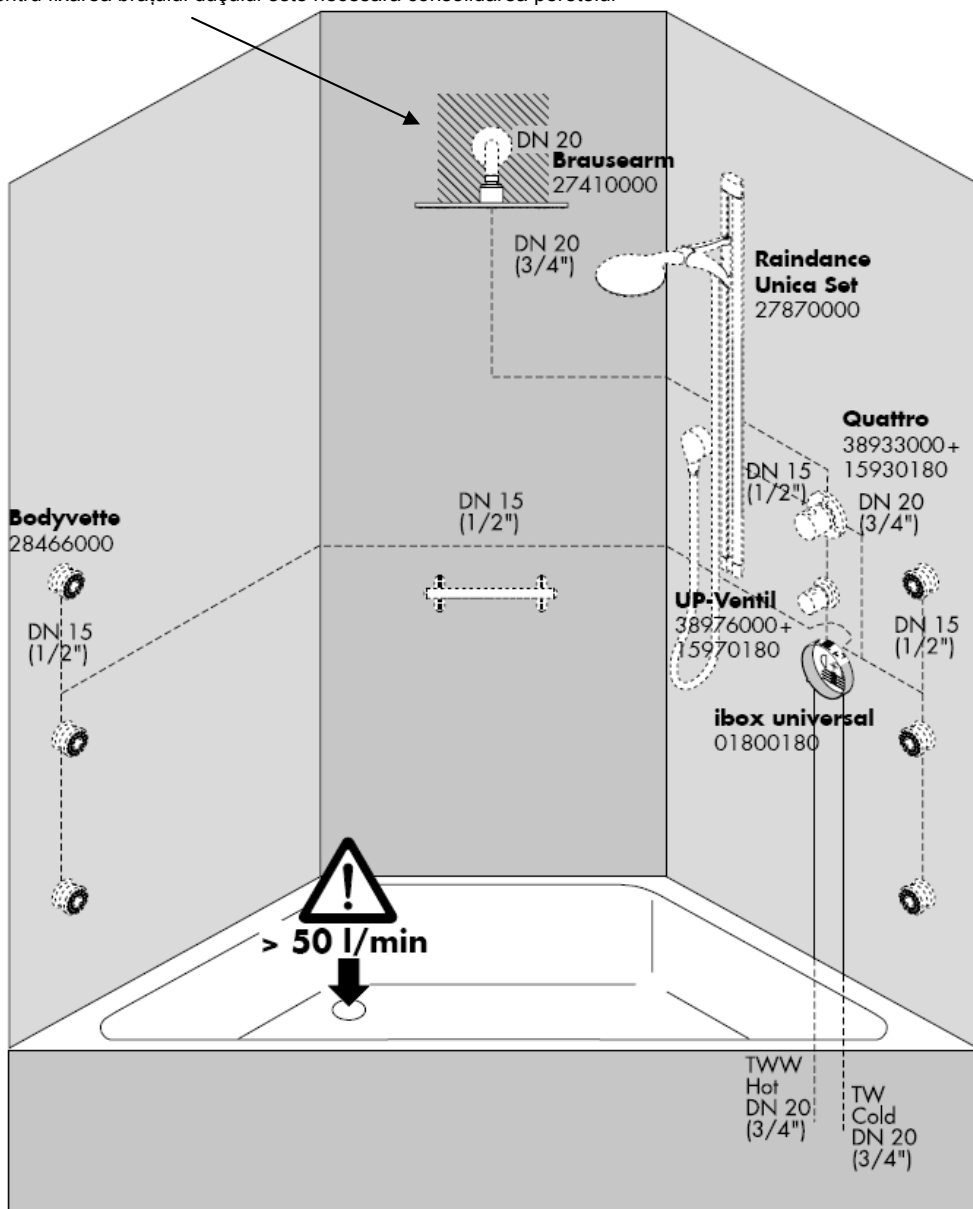

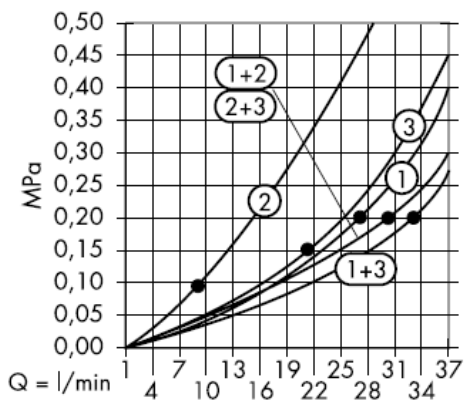

Începând de la • funcționarea este garantată.

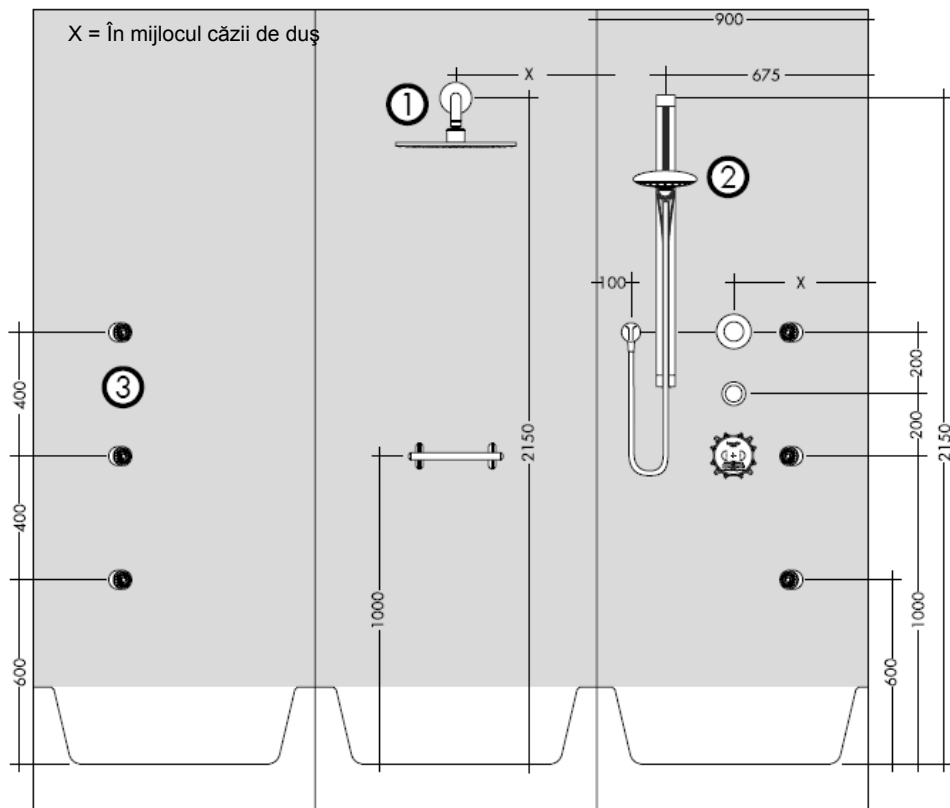

Pentru fixarea brațului dușului este necesară consolidarea peretelui

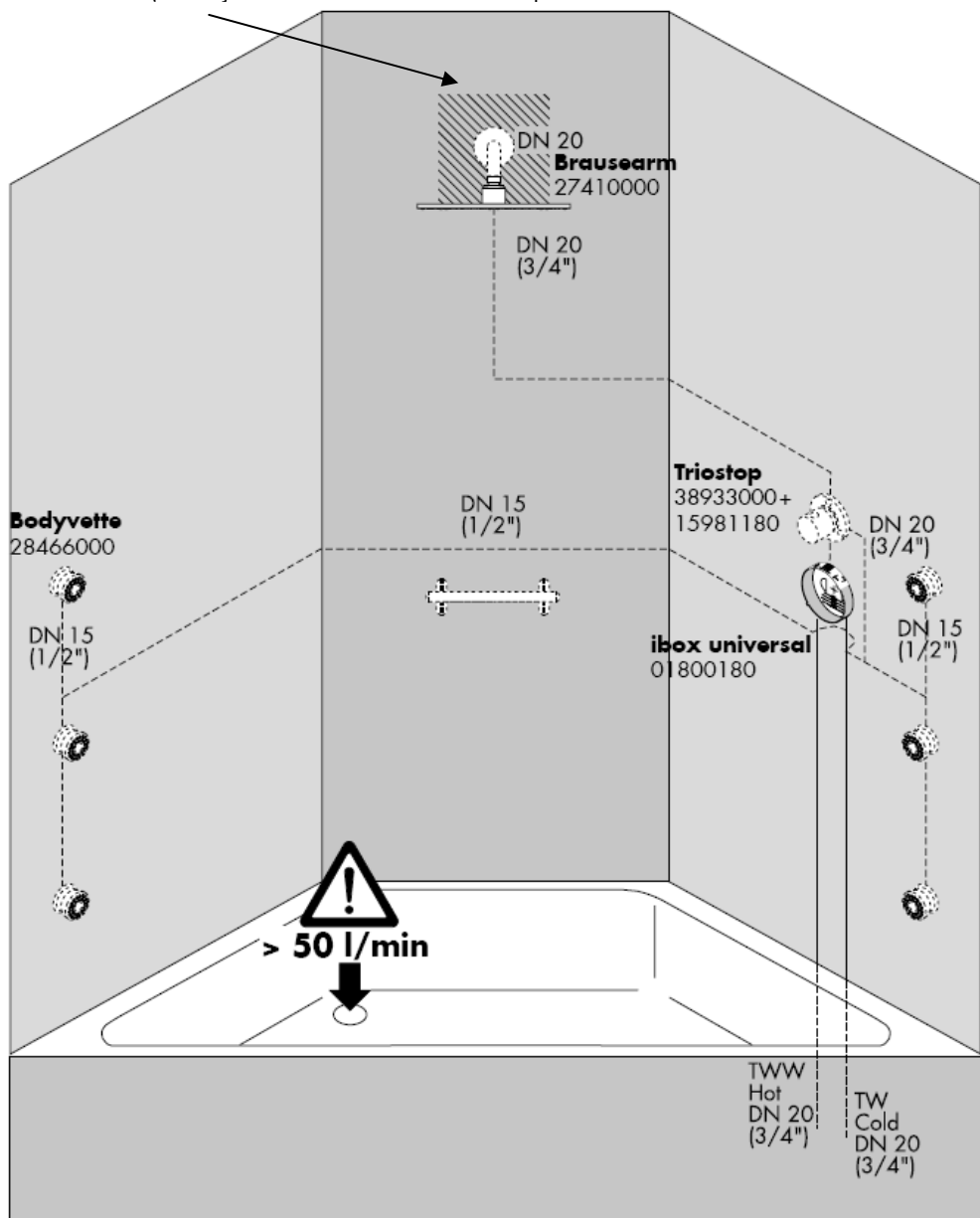

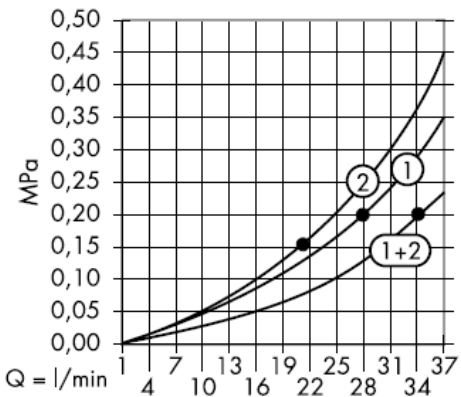

Începând de la • funcționarea este garantată.

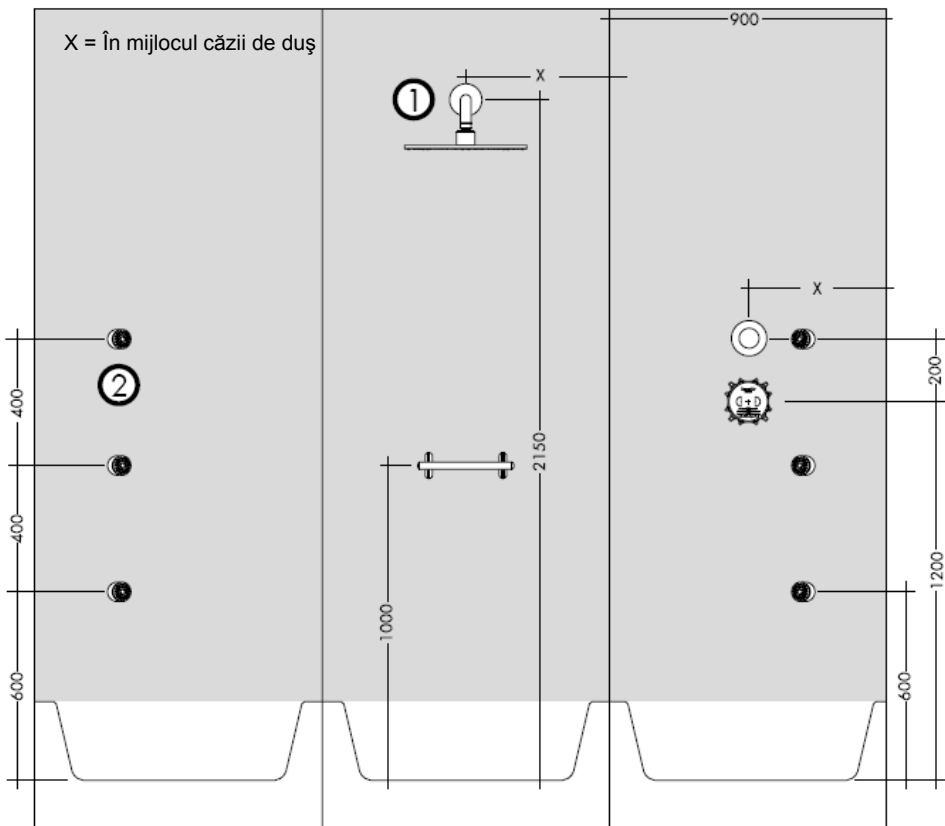

Pentru fixarea brațului dușului este necesară consolidarea peretelui

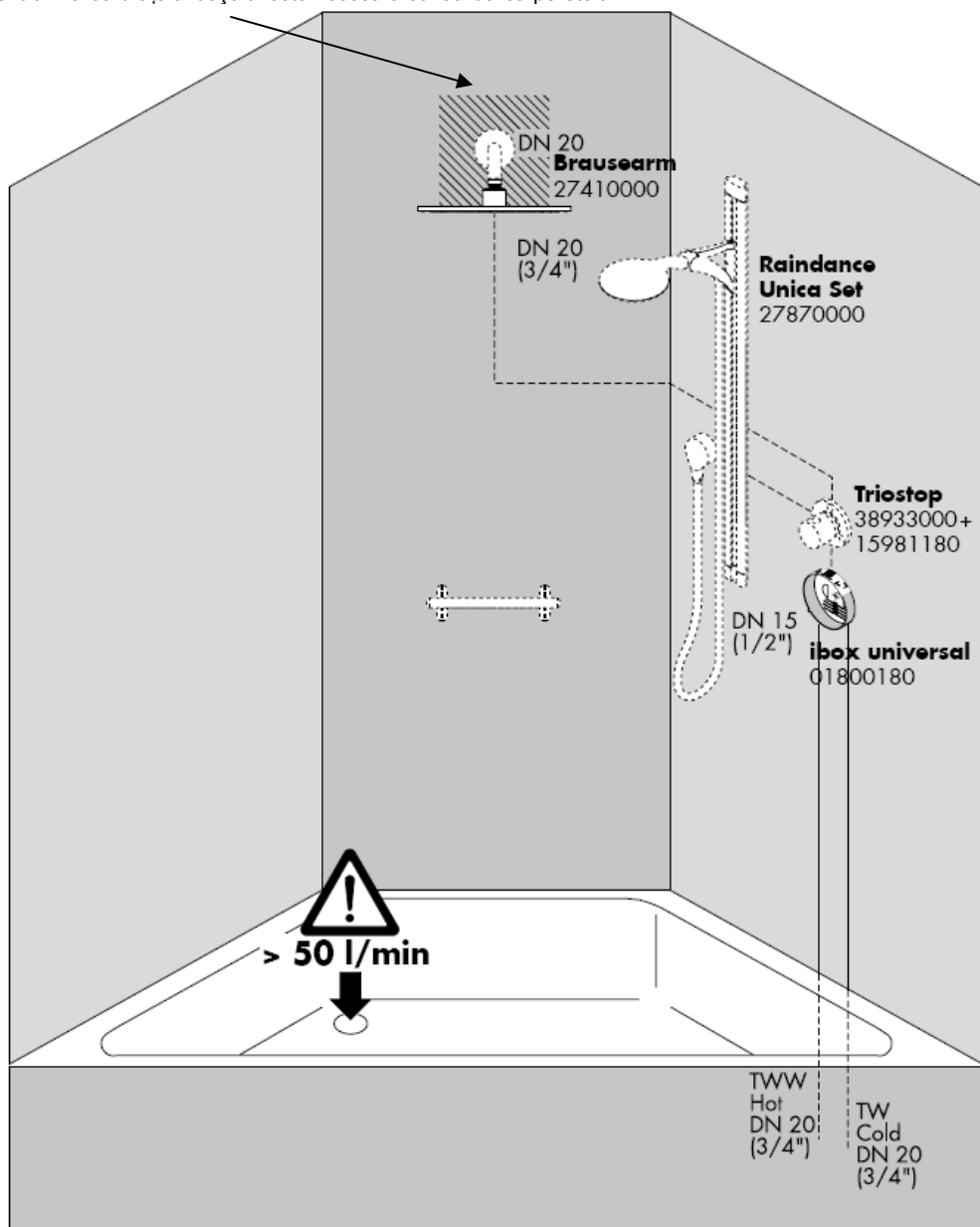

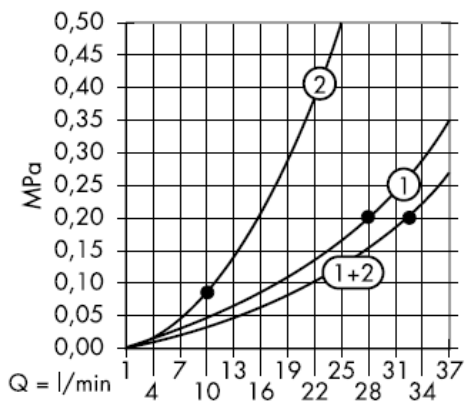

Începând de la • funcționarea este garantată.

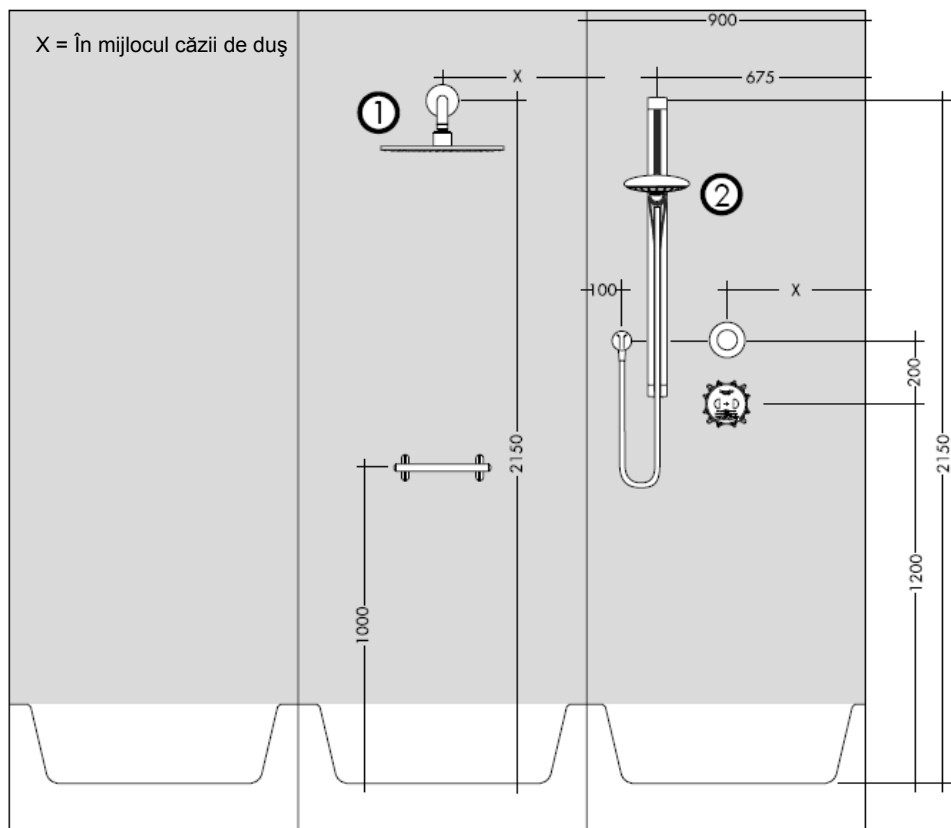

Pentru fixarea brațului dușului este necesară consolidarea peretelui

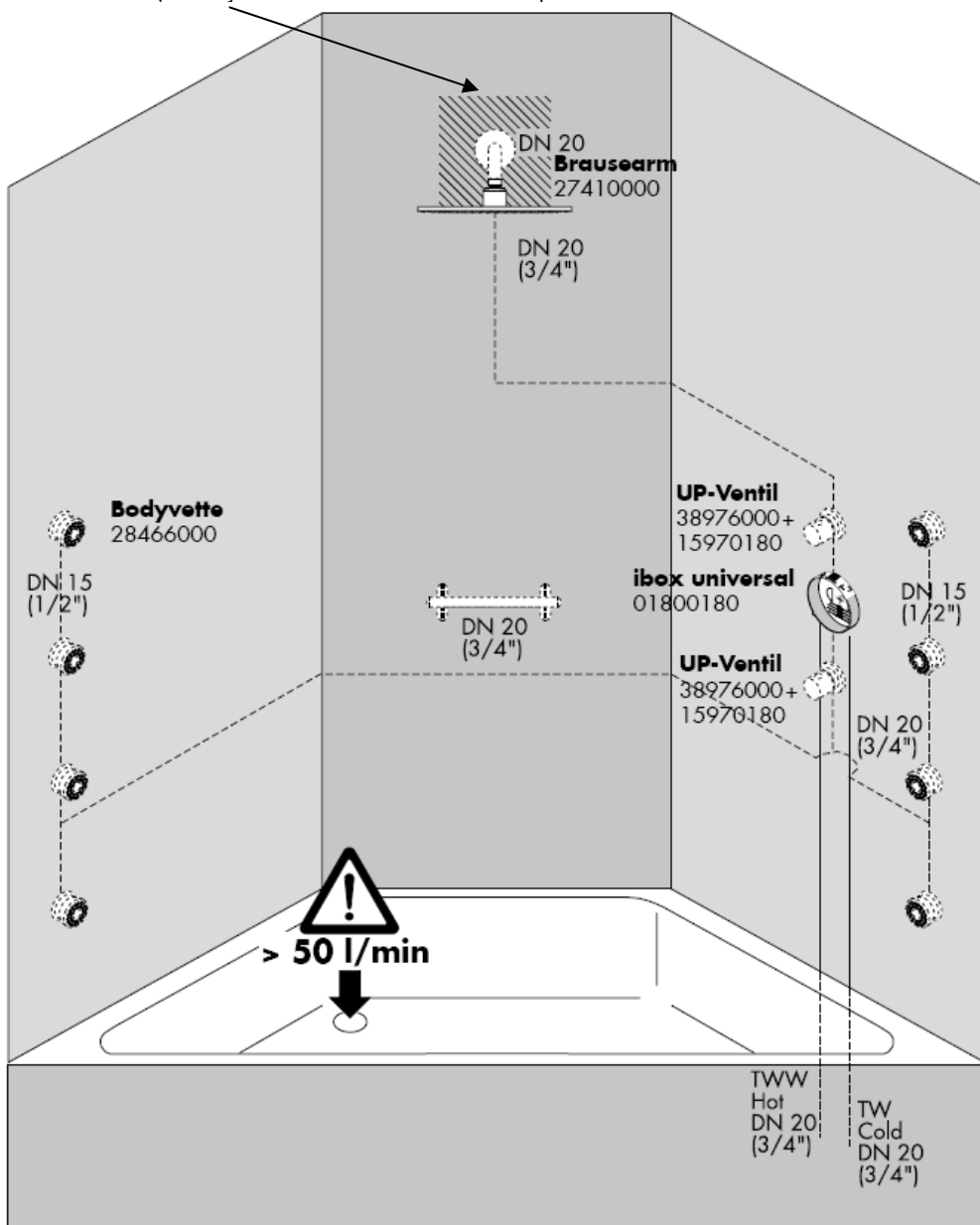

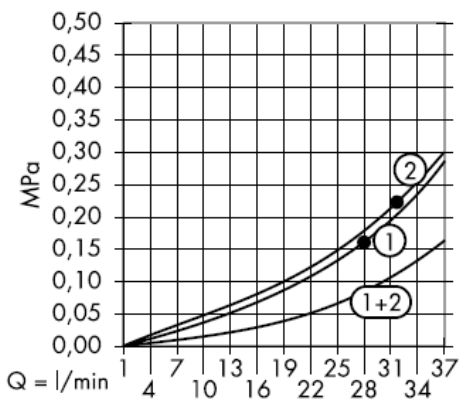

Începând de la • funcționarea este garantată.

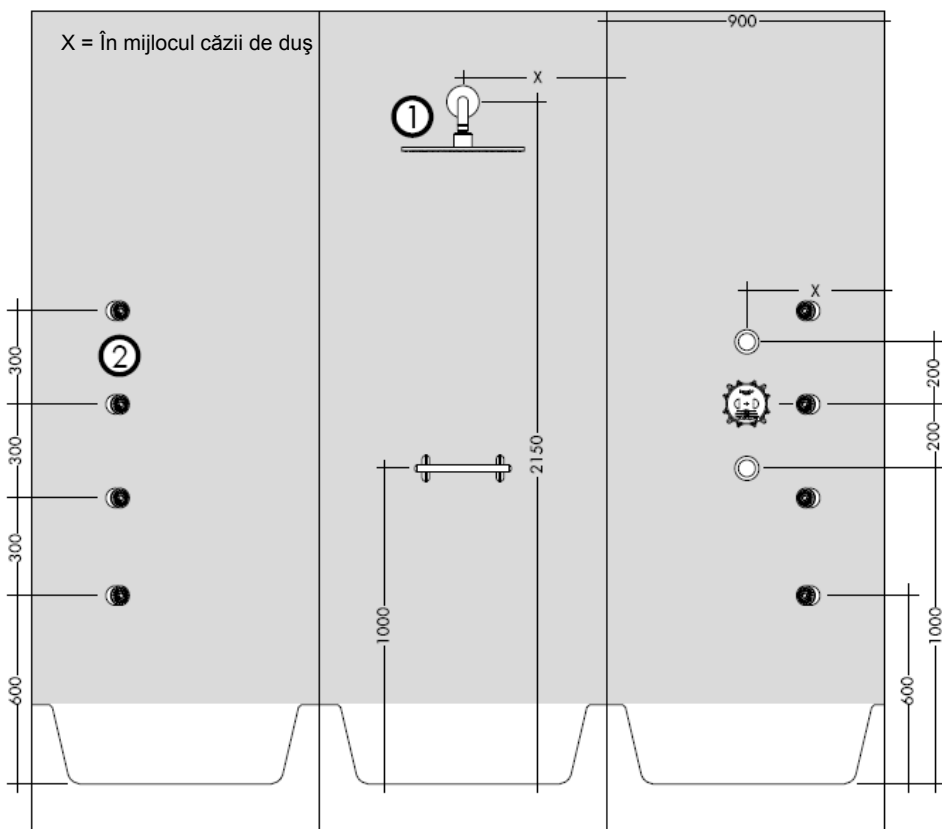

Pentru fixarea brațului dușului este necesară consolidarea peretelui

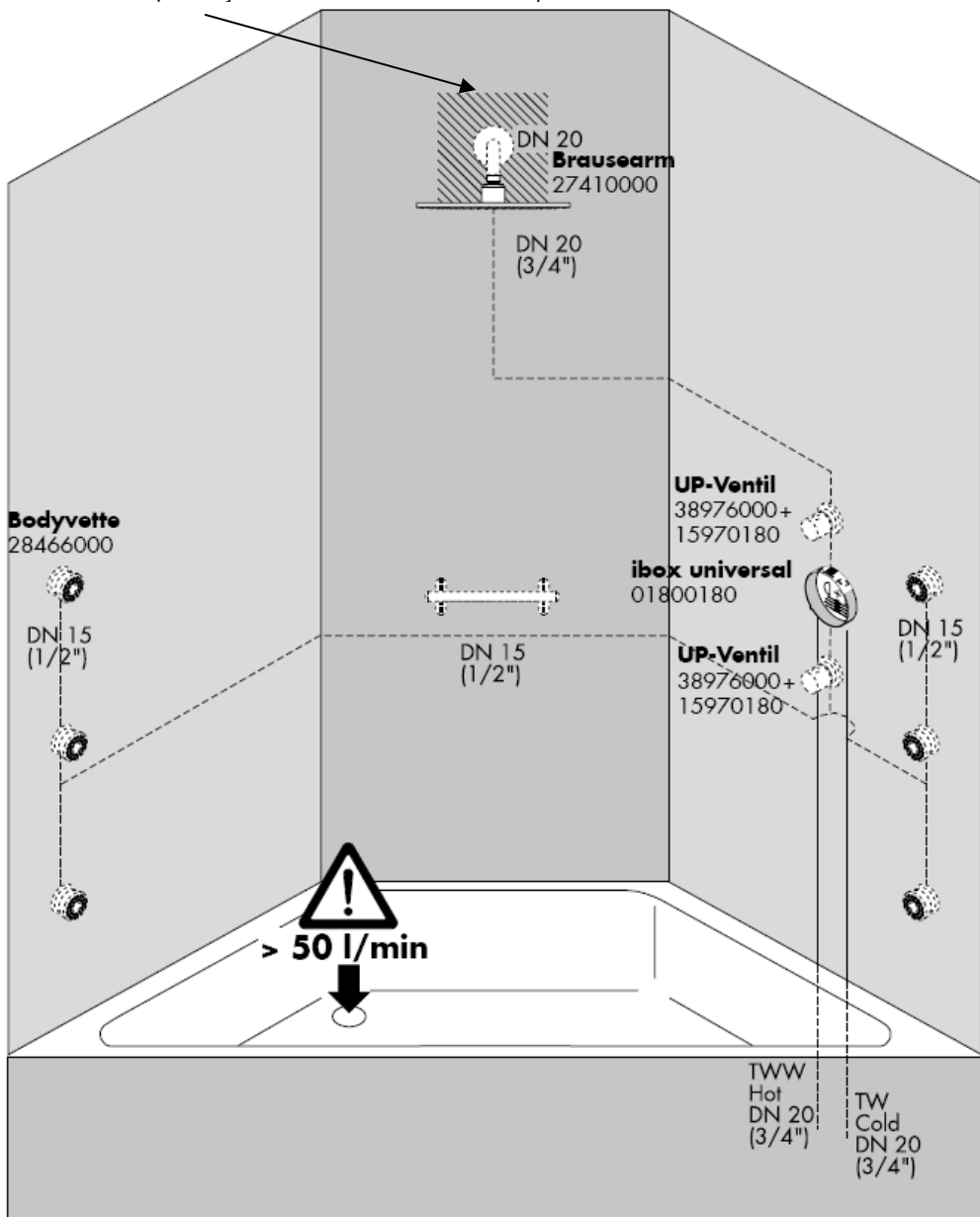

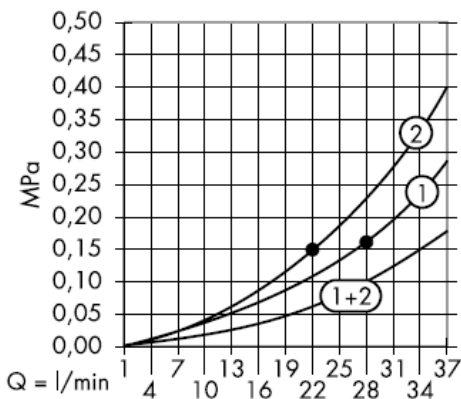

Începând de la • funcționarea este garantată.

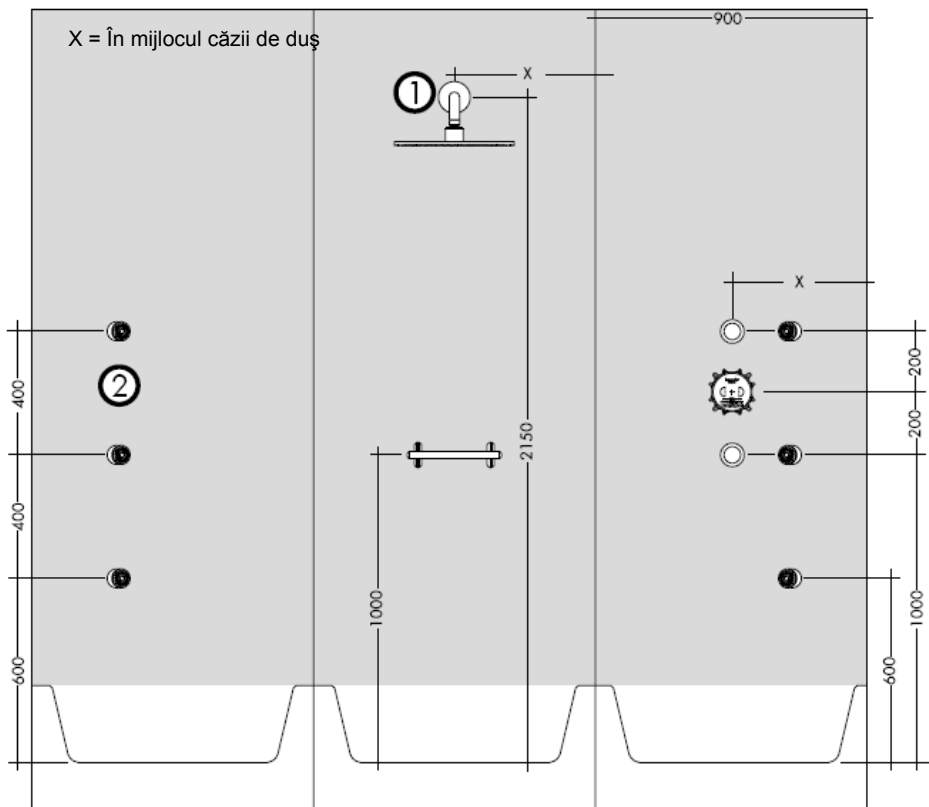

Pentru fixarea brațului dușului este necesară consolidarea peretelui

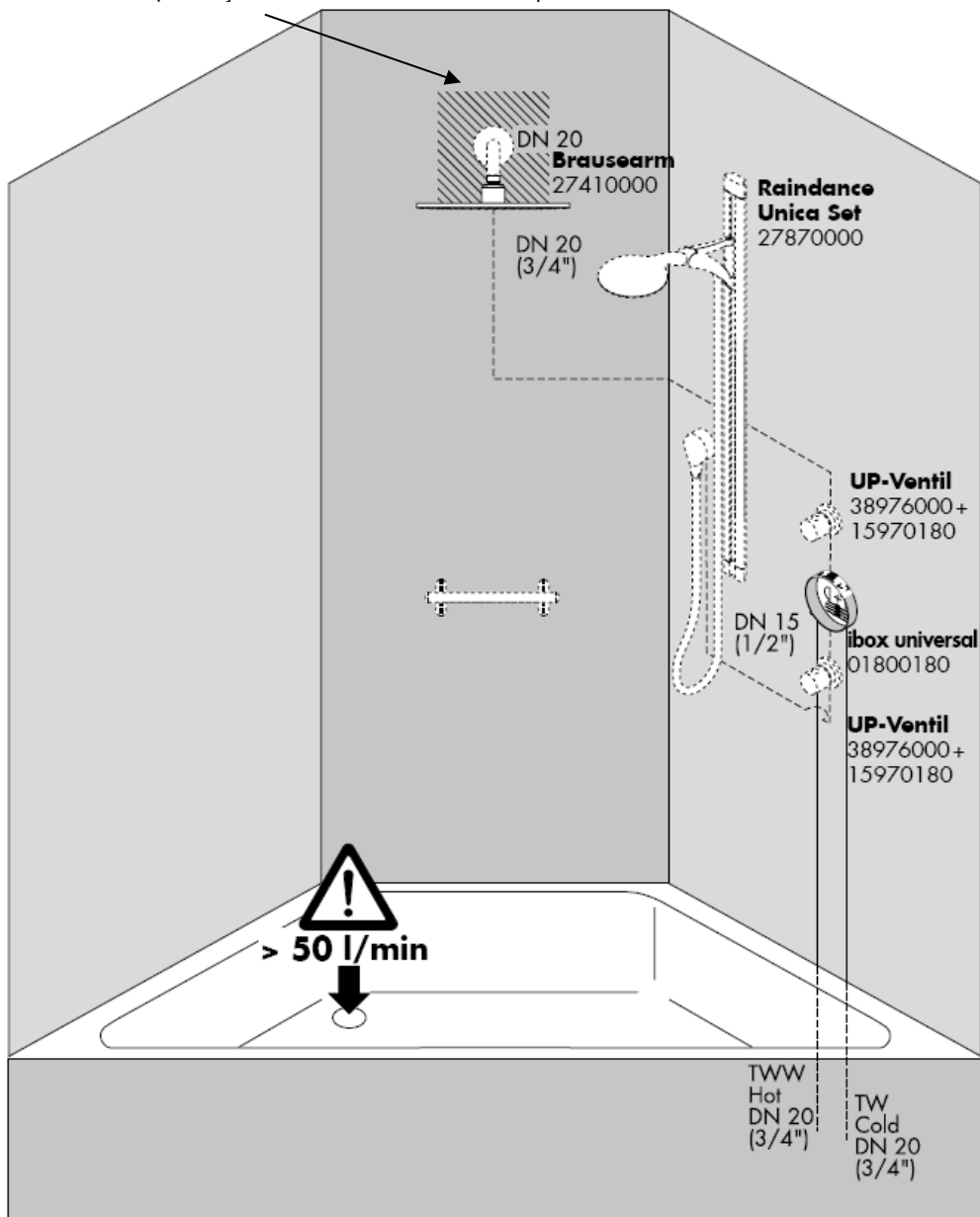

Pentru fixarea brațului dușului este necesară consolidarea peretelui

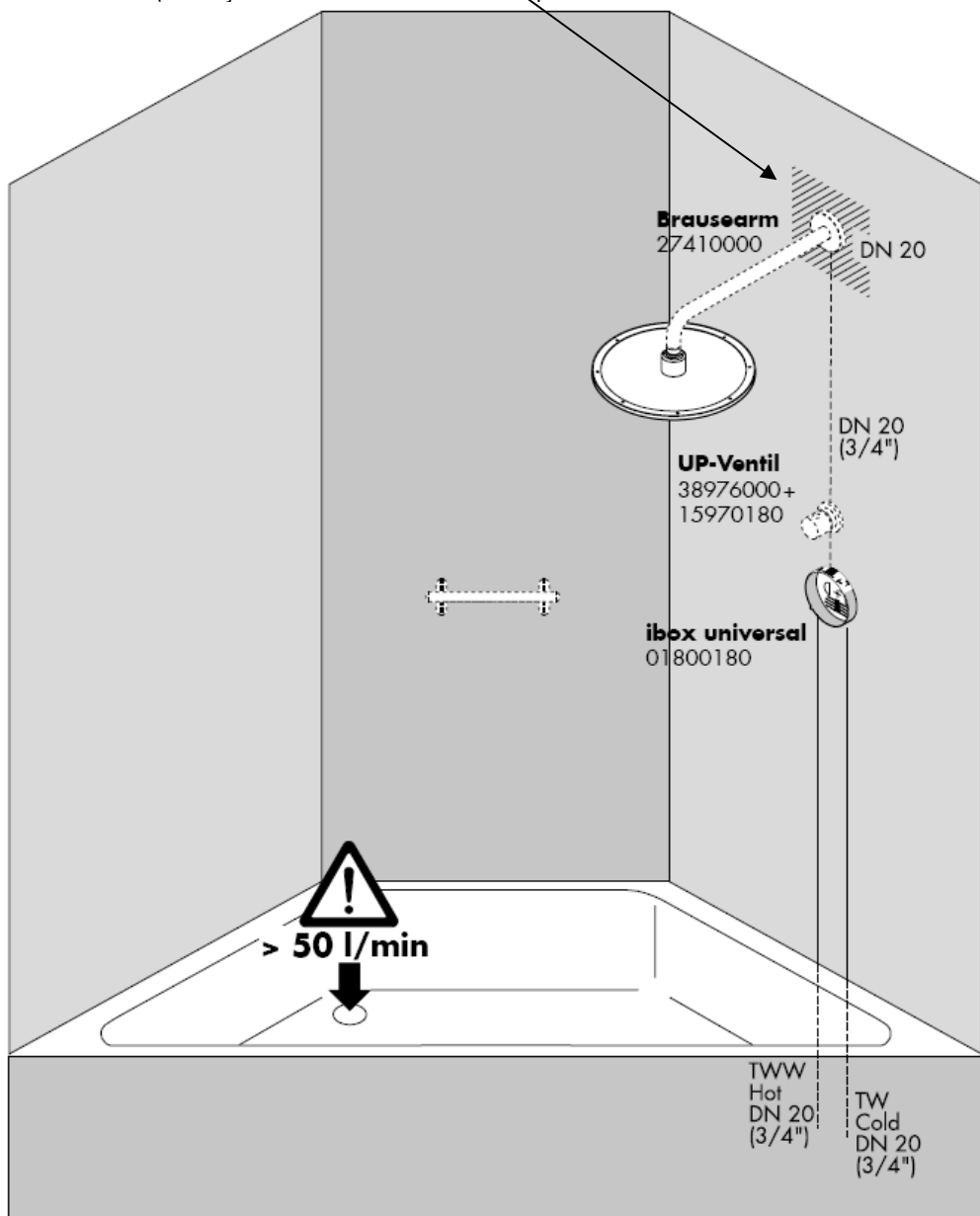

Pentru fixarea brațului dușului este necesară consolidarea peretelui

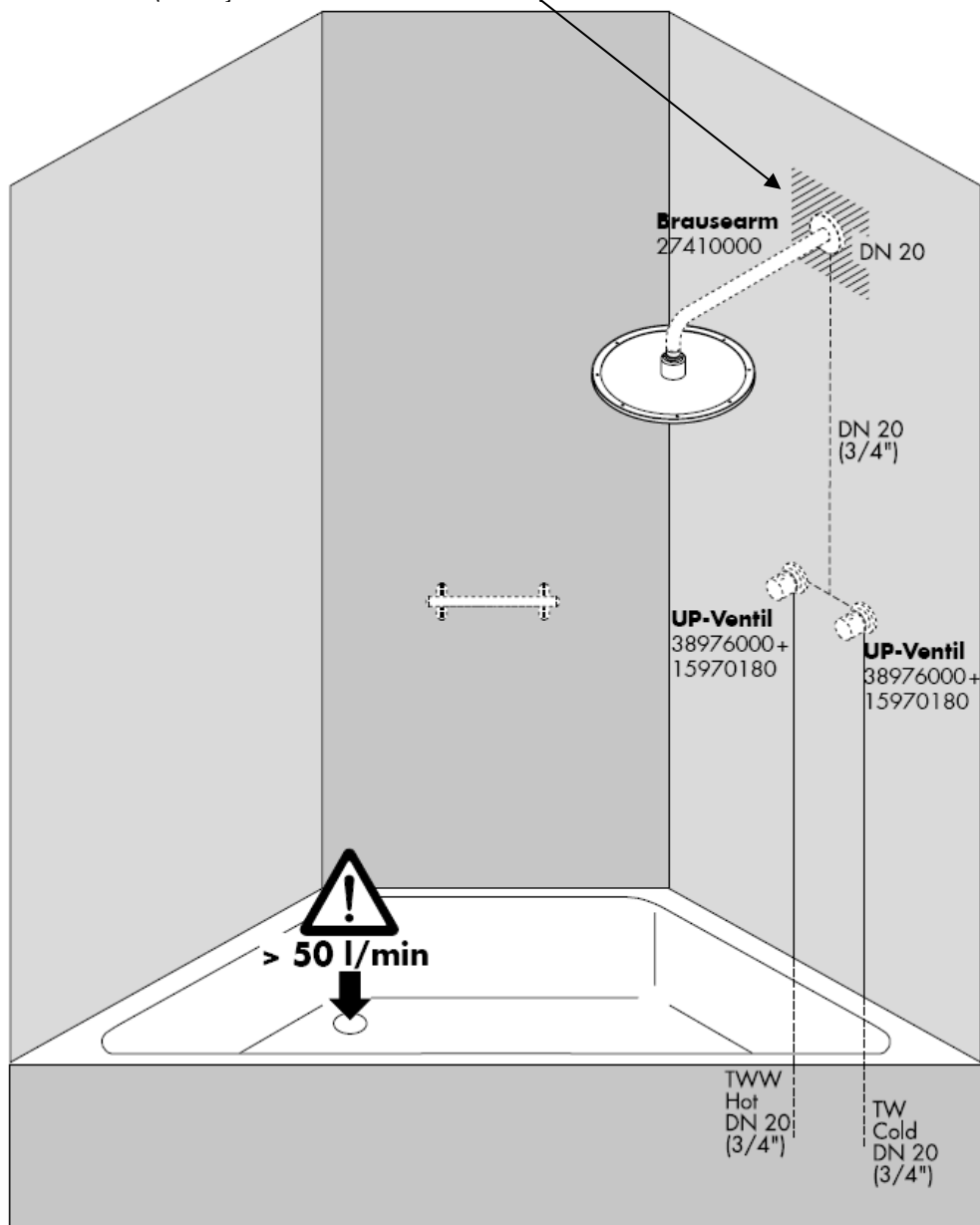

Începând de la • funcționarea este garantată.

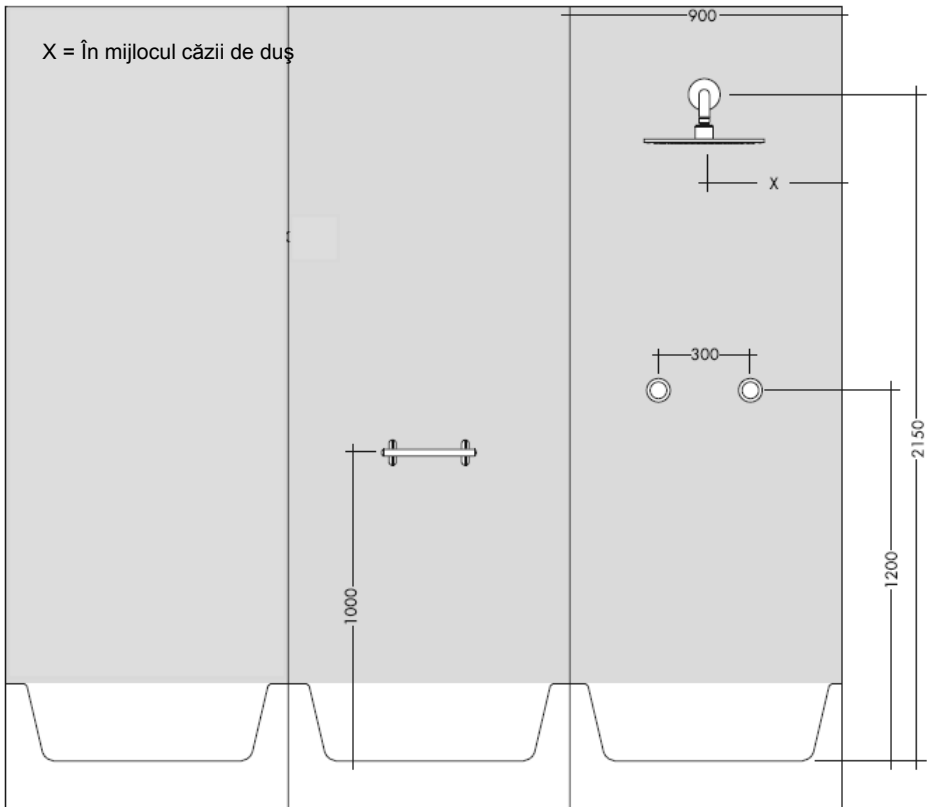
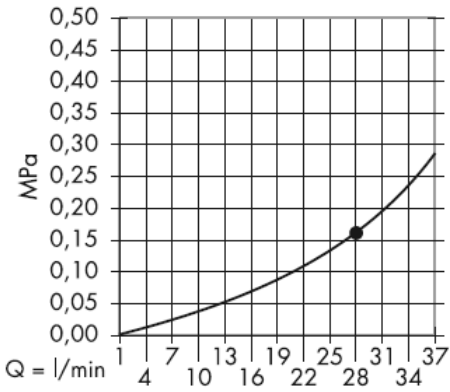

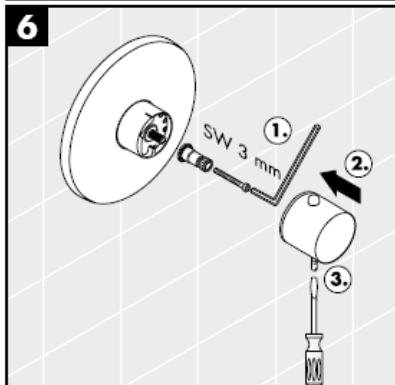
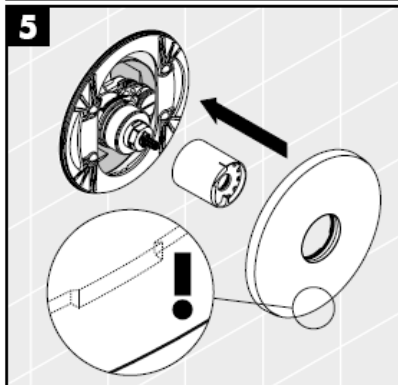
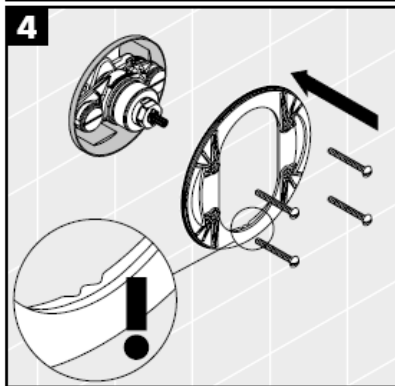
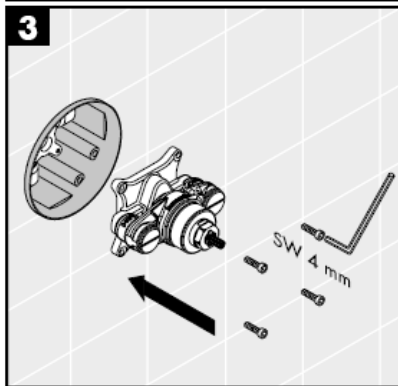
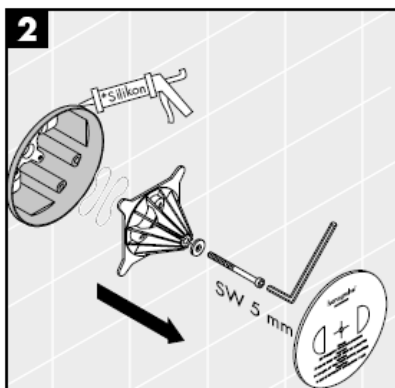
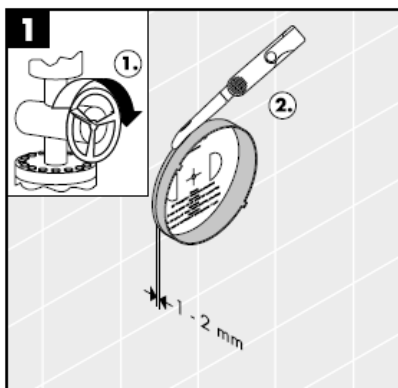

Silicon (fără acid acetic!)

Datorită funcției de siguranță puteți prerogla temperatura maximă, de ex. 42 C.

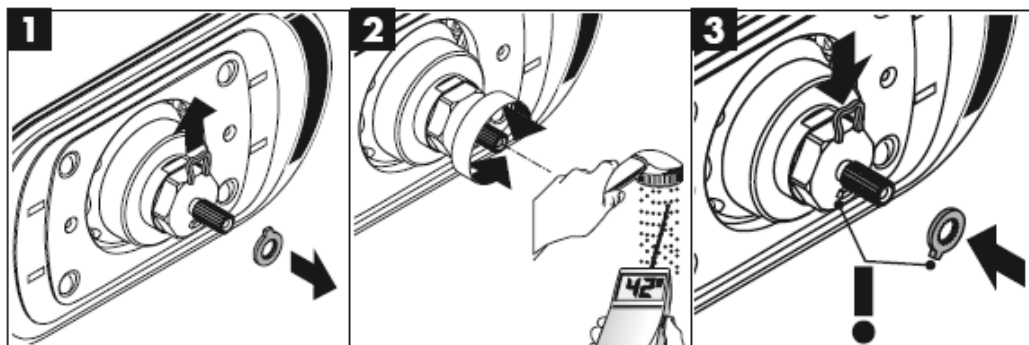

Reglare

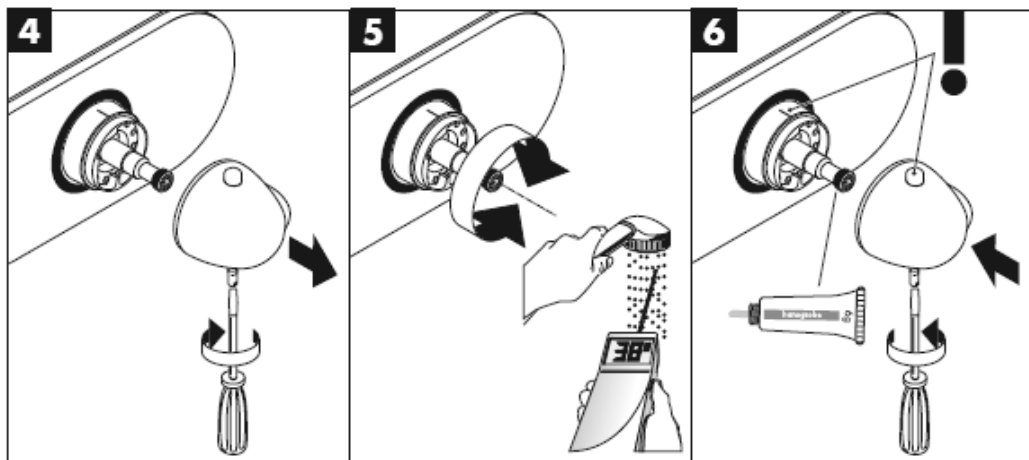



În timpul funcționării dușului, acesta atinge împreună cu bar de duș o greutate de cca. 10 kg. De aceea utilizați numai materiale de fixare potrivite pentru zidărie! Șuruburile și diblurile anexate sunt potrivite pentru zidării masive.

Utilizați numai materiale potrivite pentru lucrări de zidărie! Șuruburile și diblurile livrate sunt potrivite pentru zidării masive.

Debitul de golire trebuie să fie suficient de mare.

Funcționarea optimă este garantată numai conectat la termostate High Flow marca Hansgrohe.

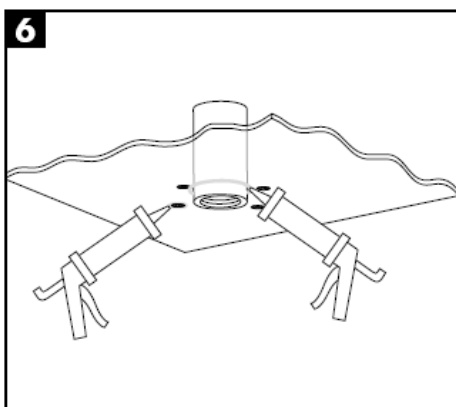
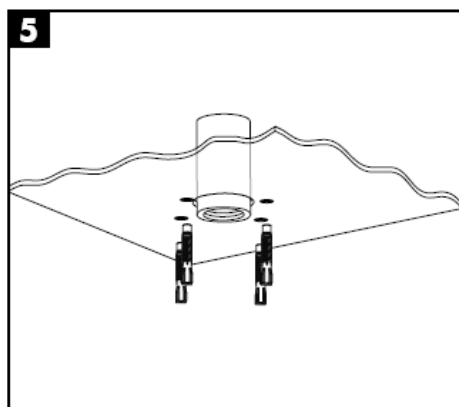
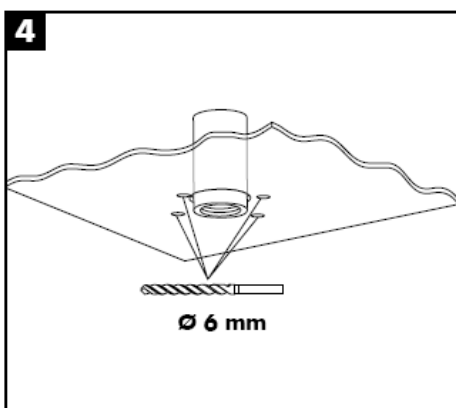
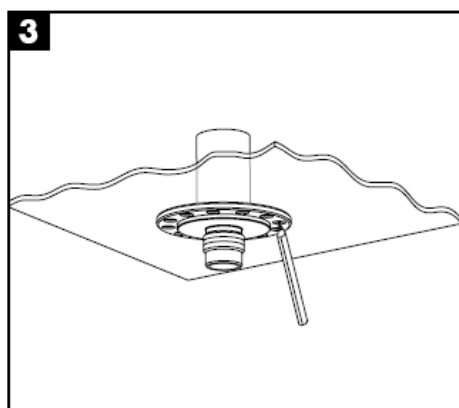
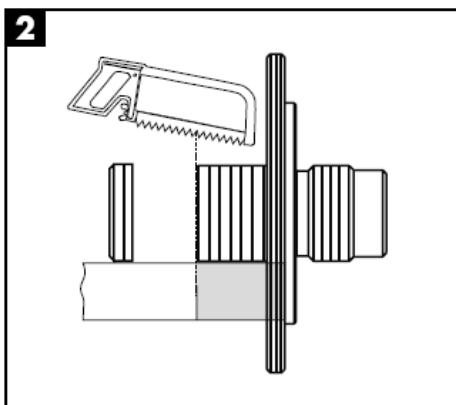
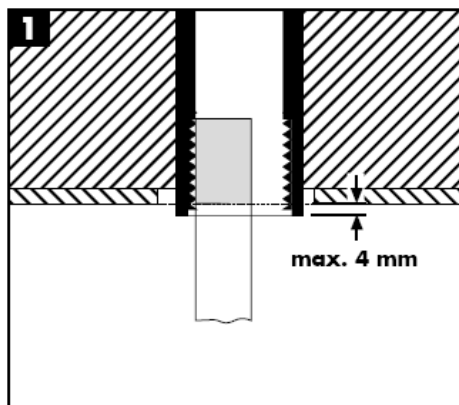

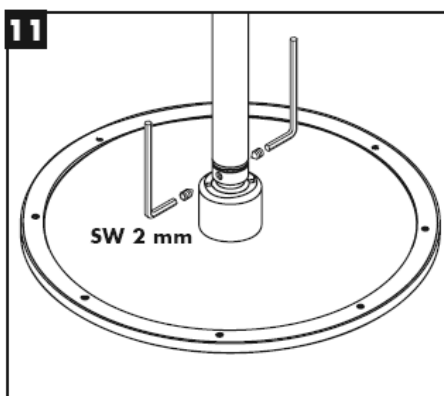
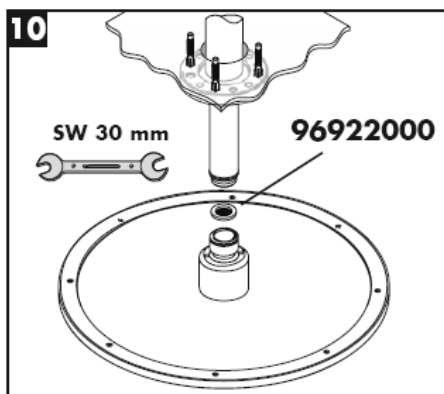
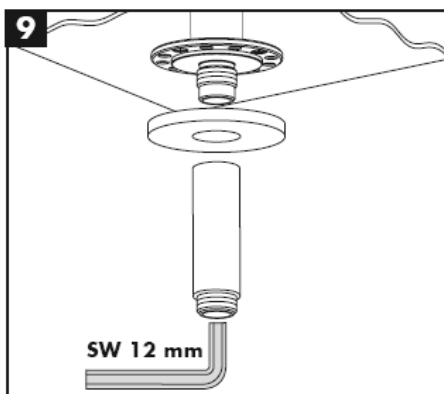
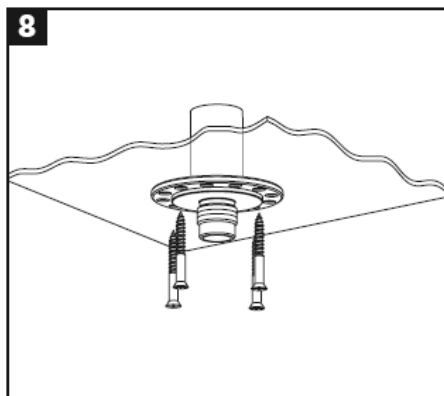
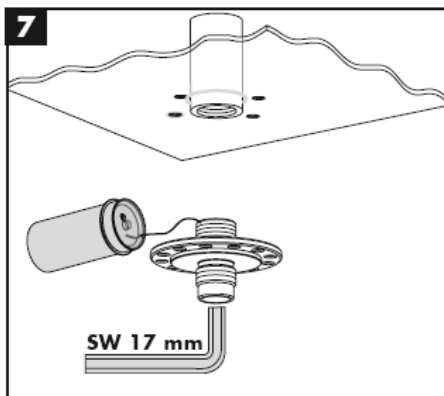

Montați garnitura de filtru livrată împreună cu capătul de duș de mână pentru evitarea pătrunderii impurităților din rețeaua de alimentare. Impuritățile pătrunse pot influența funcționarea aparatului și/sau provoca deteriorarea capătului de duș. Garanția nu acoperă aceste daune.

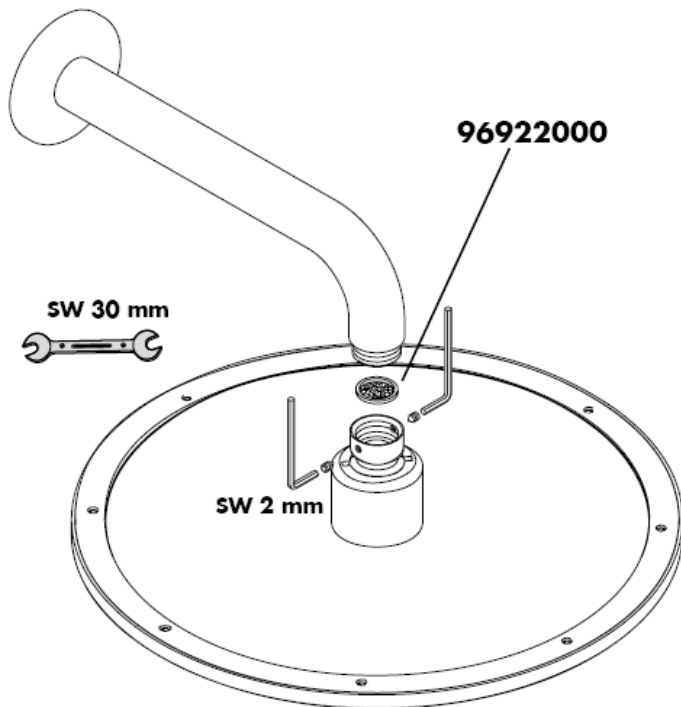

Montare

Atenție! Bateria trebuie montată, clătită și verificată conform normelor în vigoare.

Reglare

Trebuie efectuată o corecție dacă există diferență între temperatura măsurată la golire și temperatura la termostat. Trebuie să aveți grijă să rotiți maneta cu gradăție până când la golire obțineți apă cu o temperatură de 38 °C. Desfaceți șuruburile manetei, trageți înapoi maneta și rotiți-l în poziția de 38 °C. Puneți înapoi maneta și strângeți șuruburile manetei (vezi pag. 22).

Limitarea temperaturii

Domeniul de temperatură este limitat la 38 °C din motive de siguranță (protecție la opărire).

Dacă doriți să setați o temperatură mai ridicată, apăsați butonul de siguranță pentru depășirea limitei de 38 °C.

Funcția de siguranță

Datorită funcției de siguranță puteți preregla temperatura maximă, de ex. 42 °C. vezi pag. 21.

Date tehnice

Presiune de funcționare: max. 1 MPa
 Presiune de funcționare recomandată: 0,1 – 0,5 MPa
 Presiune de verificare: 1,6 MPa
 (1 MPa = 10 bar = 147 PSI)
 Temperatura apei calde: max. 80 °C
 Temperatura recomandată a apei calde: 65 °C
 Debit de apă: ca. 58 l/min, 0,3 MPa

Întreținere

Termostatele nu necesită întreținere specială. Supapele de reținere trebuie verificate regulat conform DIN EN 1717 și standardele naționale sau regionale (anual conform DIN 1988). Verificați cu această ocazie și sita pentru impurități aflată pe unitatea de reglare MTC (6.1). După montarea unității de reglare MTC (6) verificați temperatura de ieșire conform celor descrise în cap. "Reglare". Verificați neapărat în prealabil, dacă s-a pornit alimentarea cu apă caldă și apa are temperatura maximă la intrare.

Pentru garantarea mișcării ușoare a unității de reglare, vă recomandăm să setați termostatul pe pozițiile limită cald și rece.

Piese de schimb vezi pag. 3

1	Manetă termostat	38391000
2	Șild	96452000
3	Bucșă	97439000
4	Șuruburi suport	96454000
5	Șild suport	96447000
6	Unitate de reglare a temperaturii	96633000
7	Sită de impurități	97367000
8	Supapă de reținere	96655000
9	Prelungitor 25 mm	13595000
10	Prelungitor 25 mm	13596000

Română

Deranjament	Cauza	Măsuri de remediere
Prea puțină apă	-Presiune de alimentare insuficientă. -Murdărie în sita de impurități a unității de reglare. -S-a murdărit garnitura de sită a capătului de duș.	-Verificați presiunea din conducte. -Curățați sitele de impurități. -Curățați garnitura sită dintre capătul duș și furtun.
Curgere încucișată, apa caldă intră în conducta de apă rece sau invers, când bateria este închisă.	-S-a murdărit / s-a defectat supapa antiretur.	-Schimbați supapa antiretur.
Temperatura apei la ieșire nu corespunde cu temperatura reglată.	-Termostatul nu a fost reglat. -Temperatura apei calde este prea mică	-Reglați termostatul. -Ridicați temperatura apei calde la o temperatură între 42 C și 65 C.
Temperatura nu poate fi reglată.	-Unitatea de reglare a temperaturii murdar sau cu depuneri de calcar. -Montați invers blocul de funcții (rotit cu 180).	-Bateria a fost racordată incorect la prima instalare. (instalați rece - dreapta, cald - stânga) sau rotit cu 180 . -Butonul de pe întrerupătorul de siguranță nu funcționează.
Arc defect	-Curățați și ungeți puțin arcul și butonul sau schimbați-le dacă este cazul. -Depuneri de calcar pe buton	-Curățați și ungeți puțin arcul și butonul sau schimbați-le dacă este cazul. -Curățați și ungeți puțin arcul și butonul sau schimbați-le dacă este cazul.

Certificat de testare

	P-IX	DVGW	SVGW	WRSA	KIWA	ACS	NF
27070000						X	
27418XXX							
28420000						X	
28435XXX						X	

Curățare

Pur și simplu curat: Calcarul se îndepărtează ușor de pe noduri prin frecare.

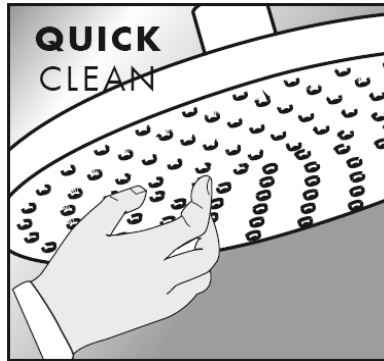

Instrucțiuni de întreținere

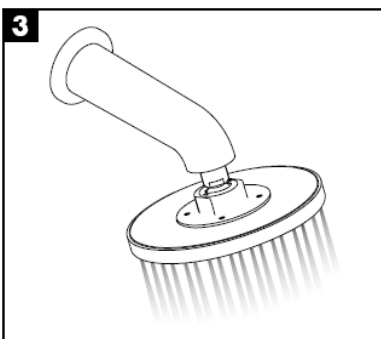
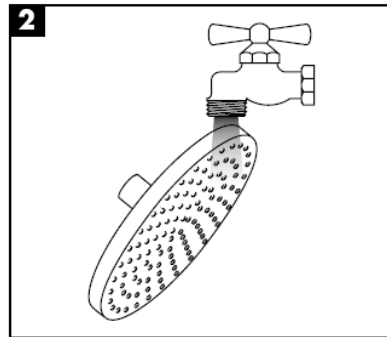
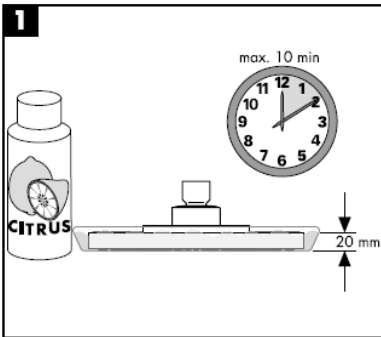

hansgrohe

Οδηγία συναρμολόγησης



27418XXX

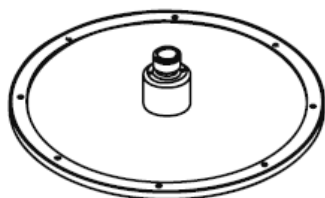

Raindance Royale AIR
28420000

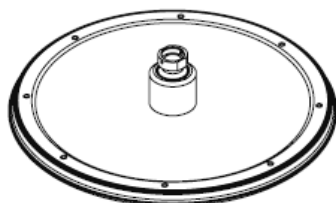

Raindance Royale Classic AIR
28435XXX

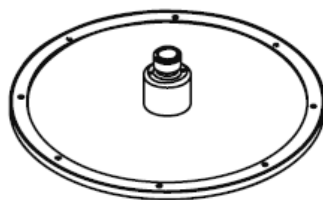

**Raindance Royale
High Flow Set**
27070000

hansgrohe

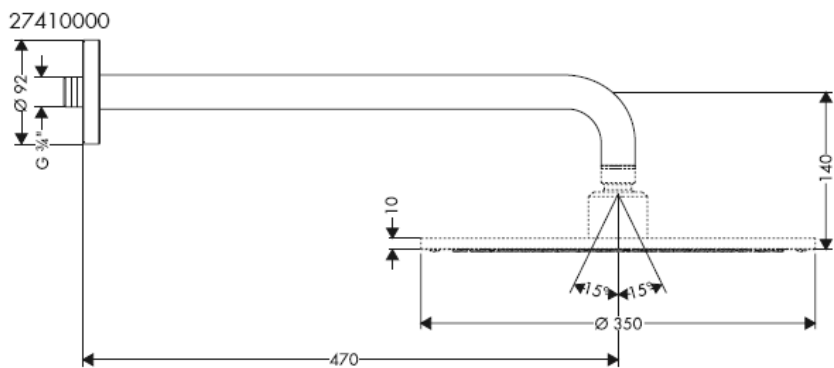
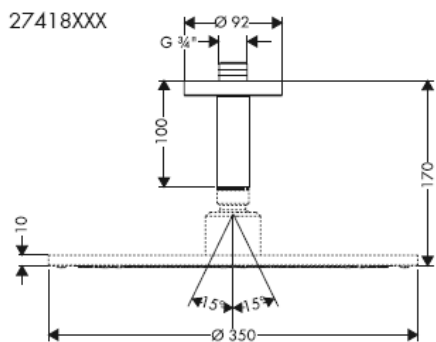
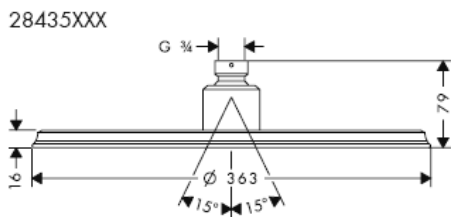
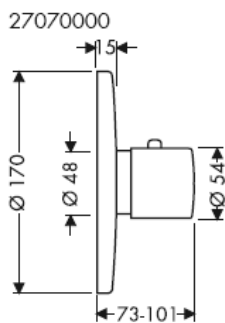
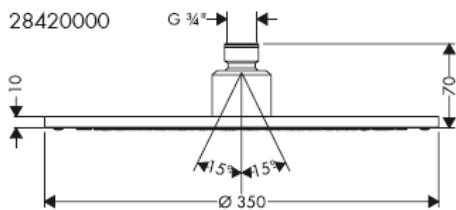

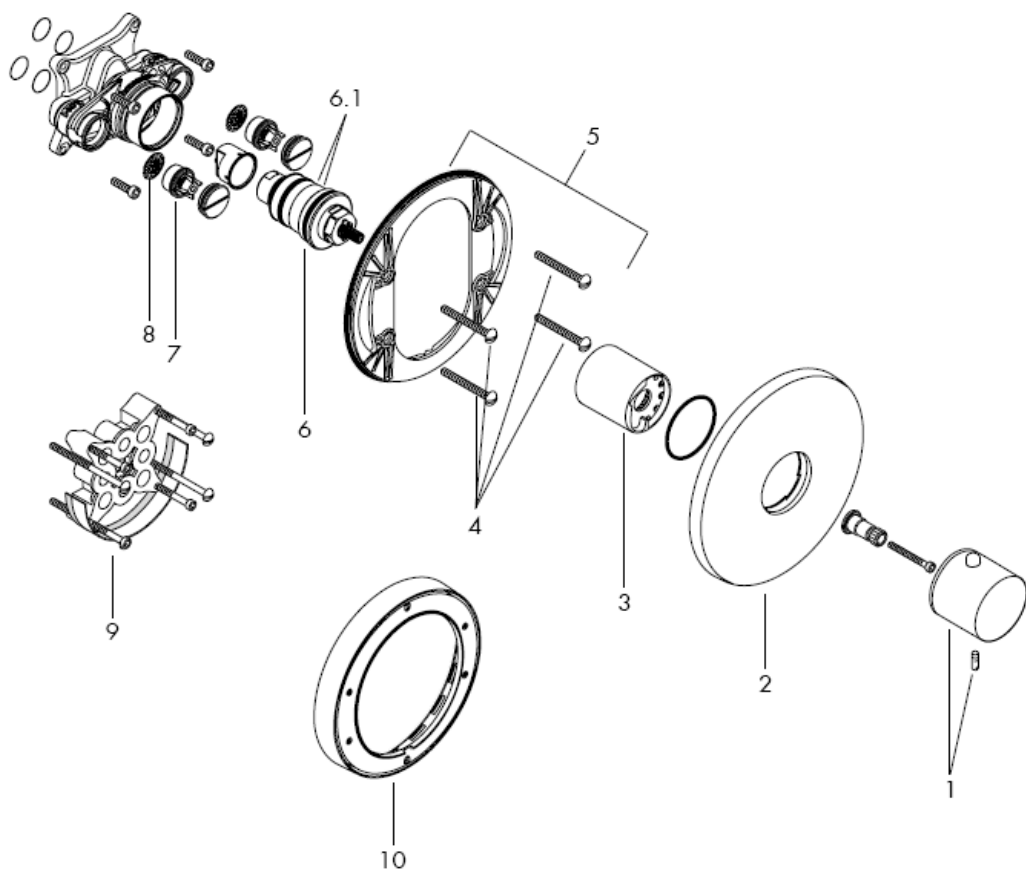

Προσαρμόστε τις διαστάσεις κατά το δυνατόν στο ράστερ των πλακιδίων.

Ενίσχυση τοίχου για στερέωση βραχίονα ντουζιέρας είναι απαραίτητη

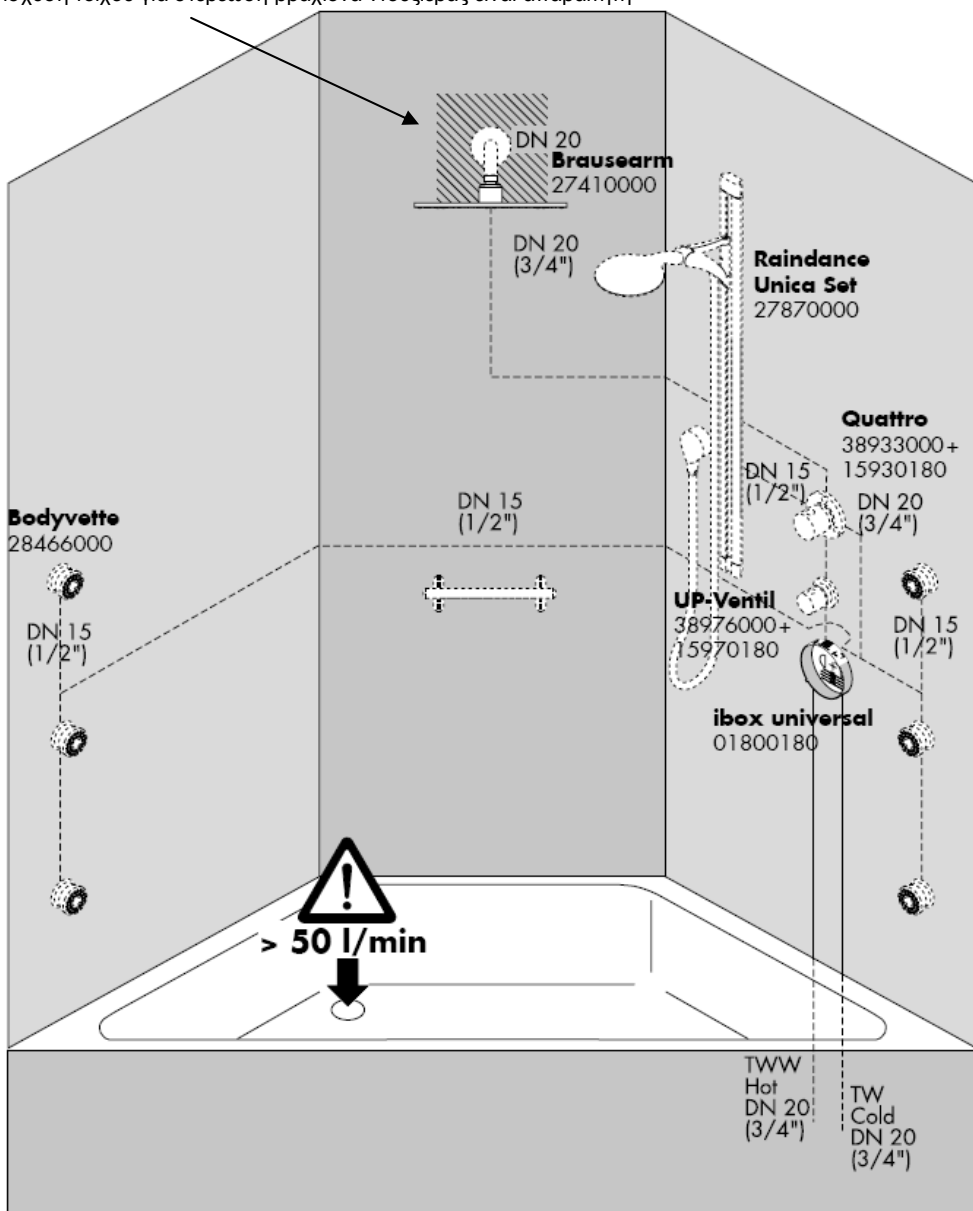

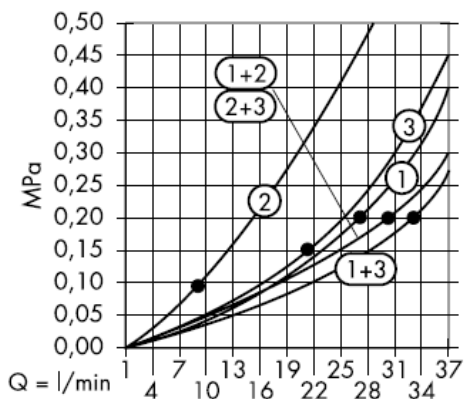

Αυτή η λειτουργία διασφαλίζεται από το σημείο κι έπειτα

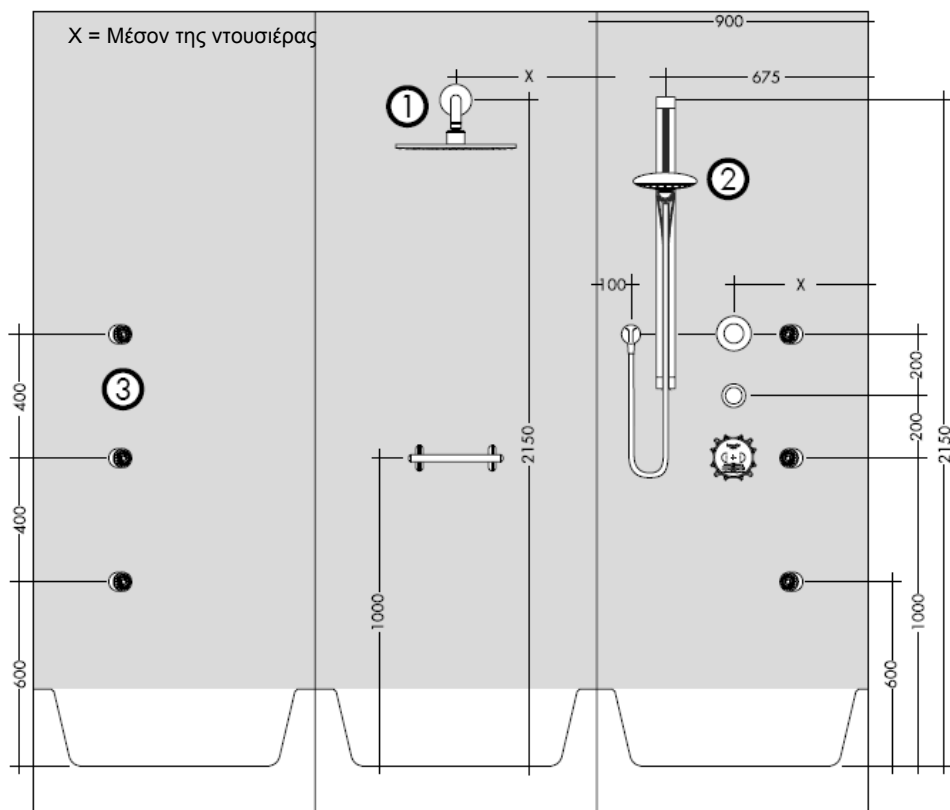

Ενίσχυση τοίχου για στερέωση βραχίονα ντουζιέρας είναι απαραίτητη

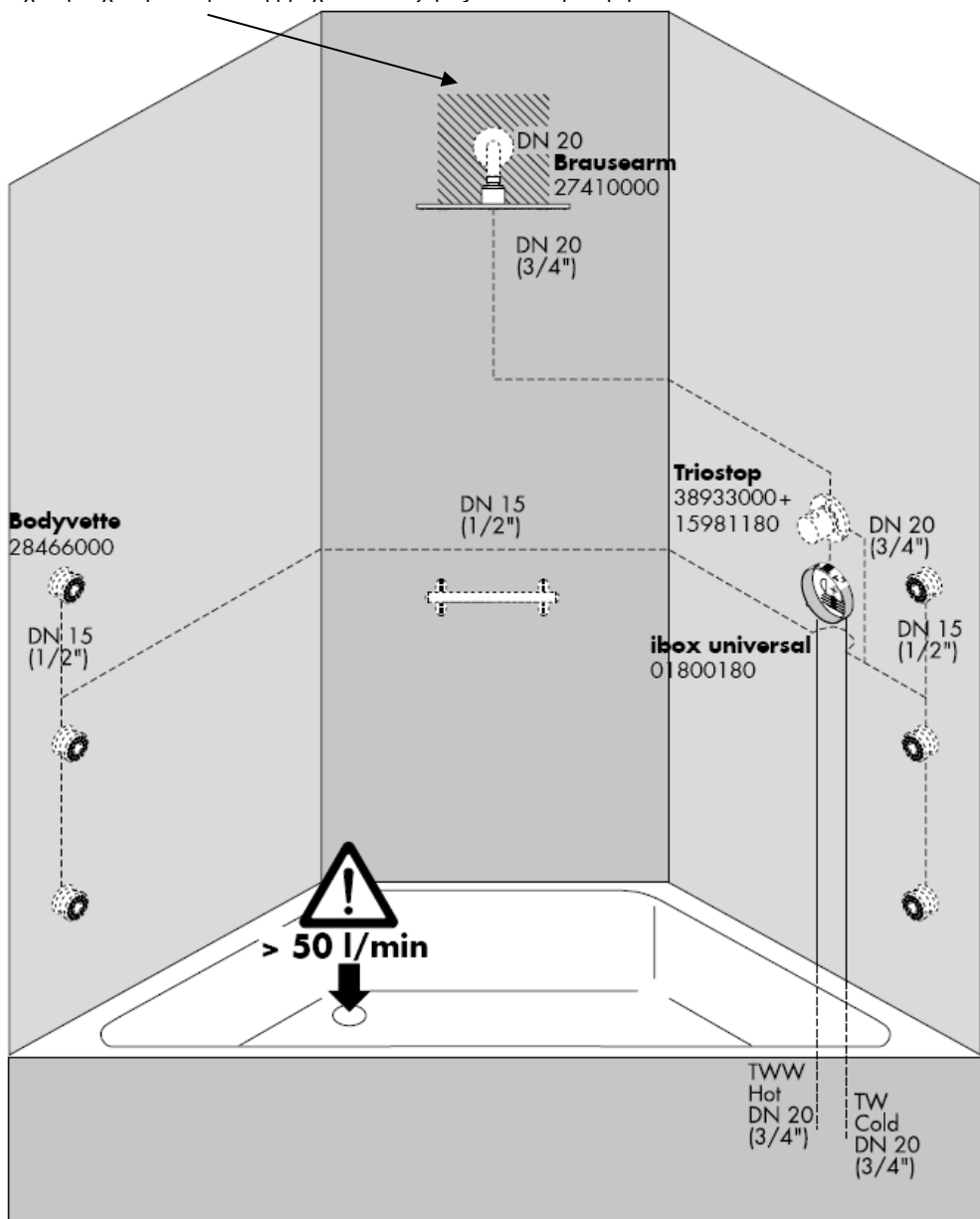

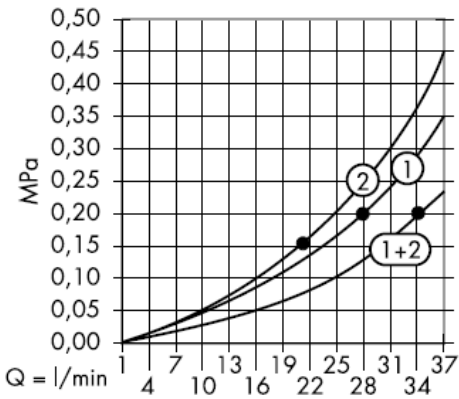

Αυτή η λειτουργία διασφαλίζεται από το σημείο κι έπειτα

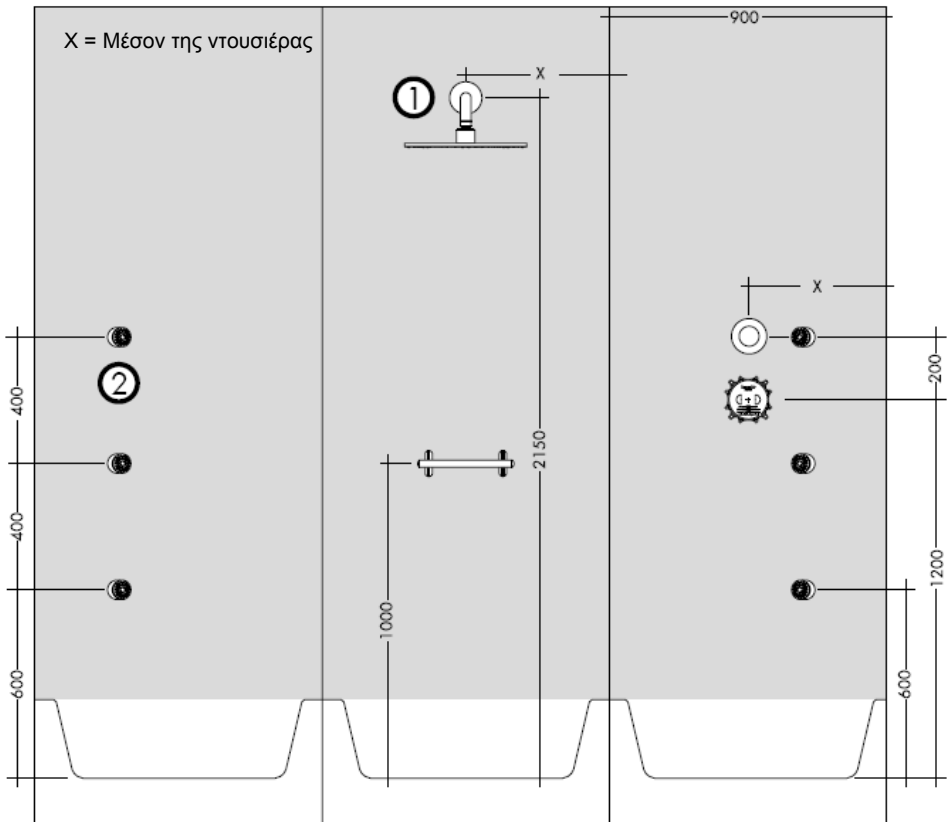

Ενίσχυση τοίχου για στερέωση βραχίονα ντουζιέρας είναι απαραίτητη

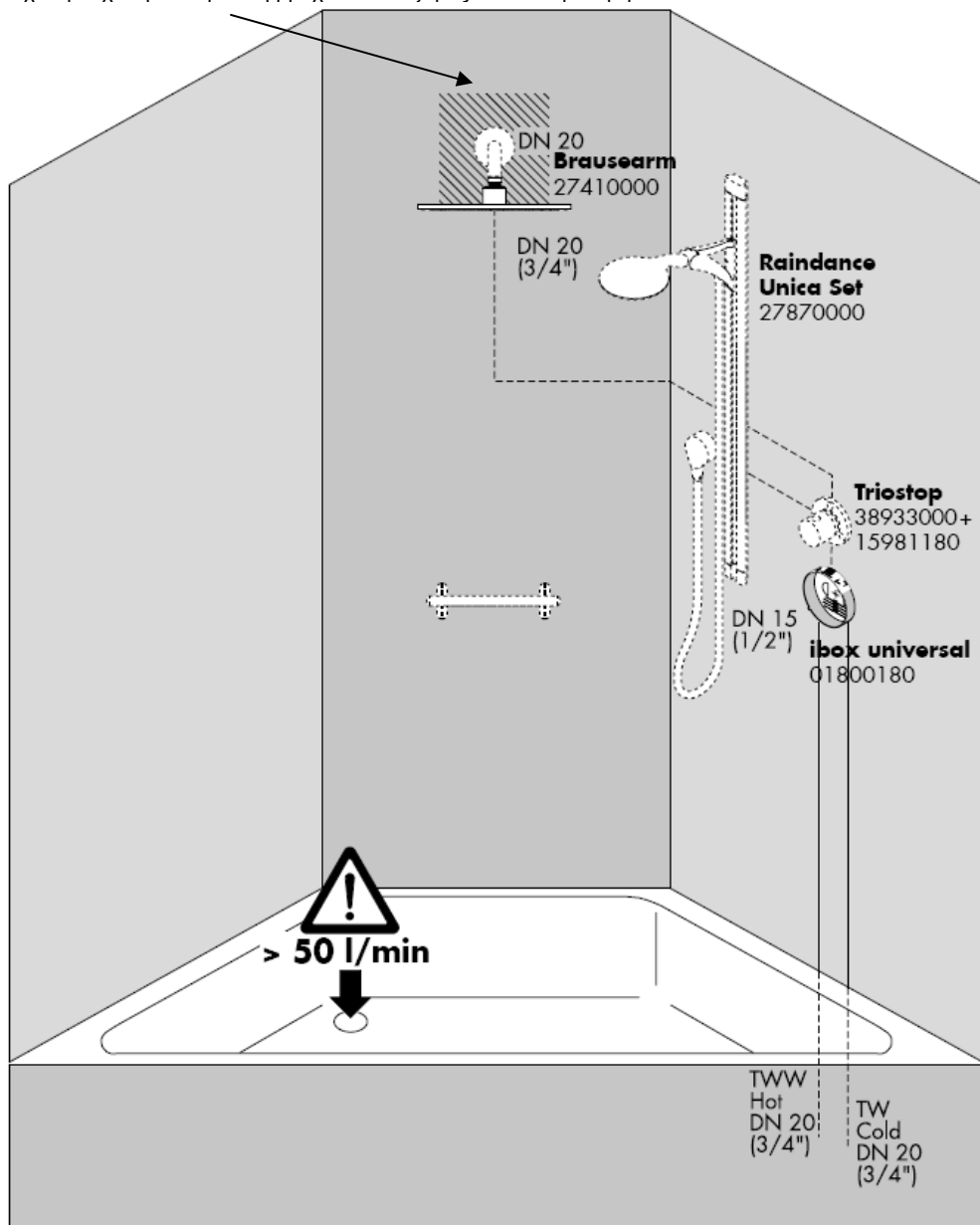

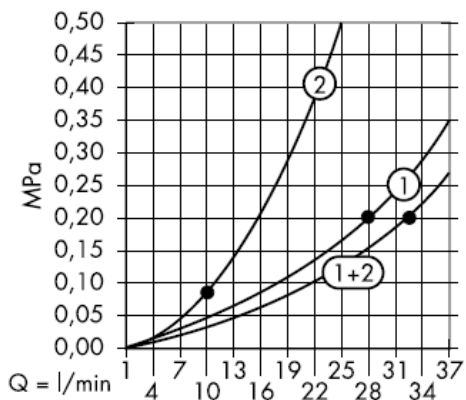

Αυτή η λειτουργία διασφαλίζεται από το σημείο κι έπειτα

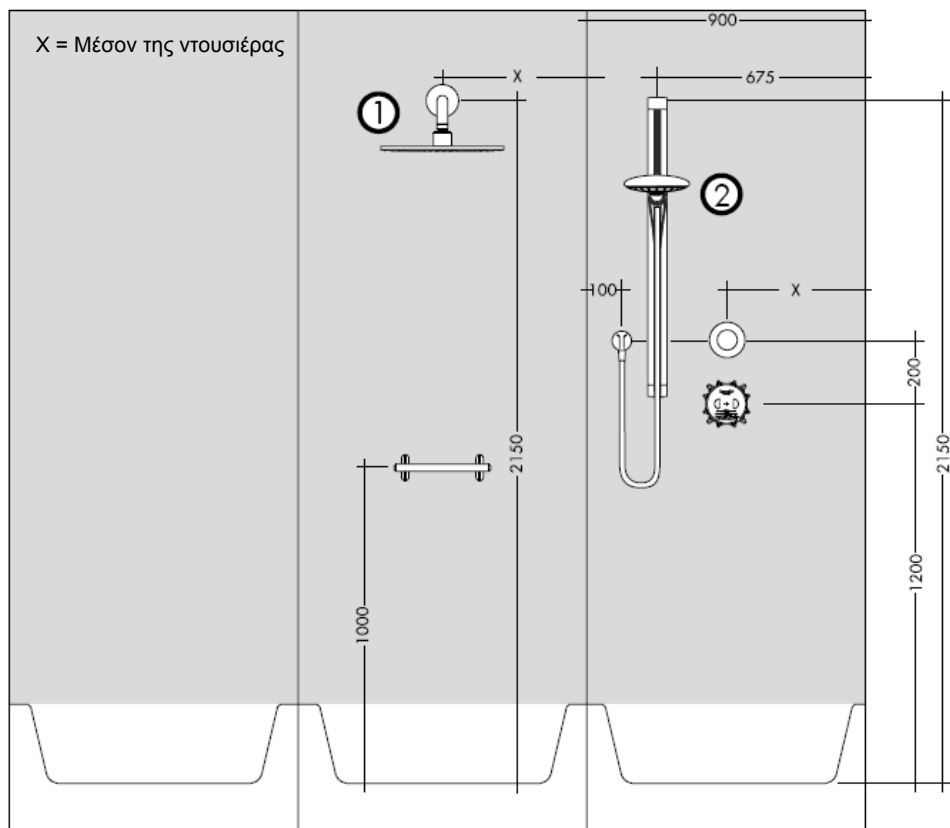

Ενίσχυση τοίχου για στερέωση βραχίονα ντουζιέρας είναι απαραίτητη

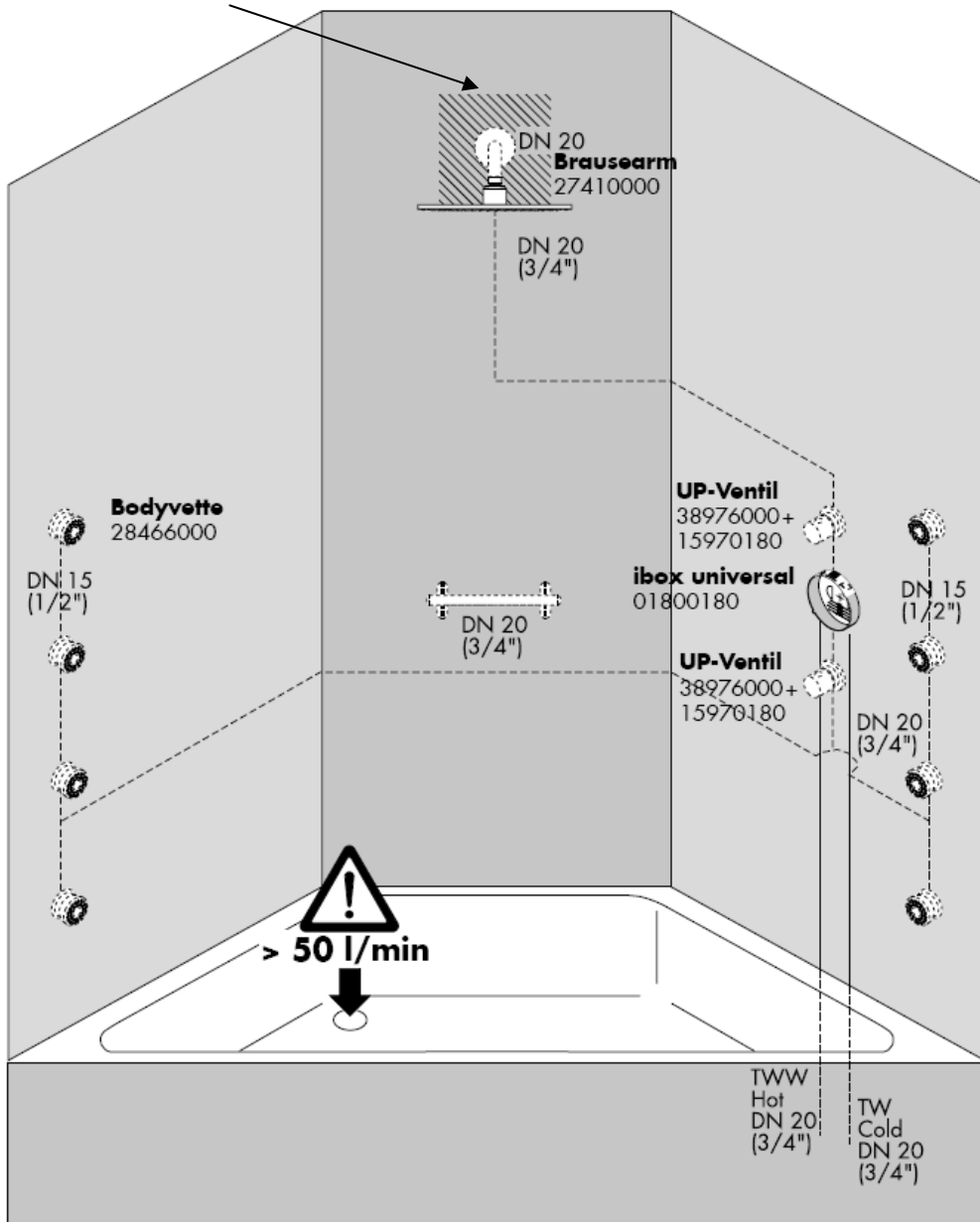

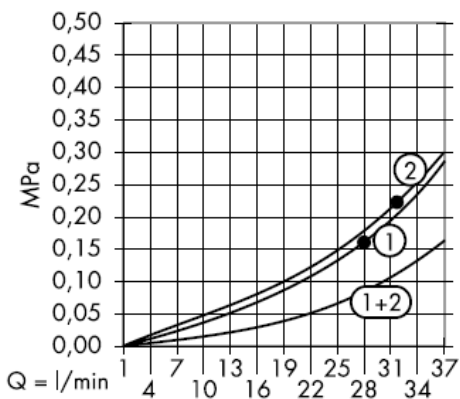

Αυτή η λειτουργία διασφαλίζεται από το σημείο κι έπειτα

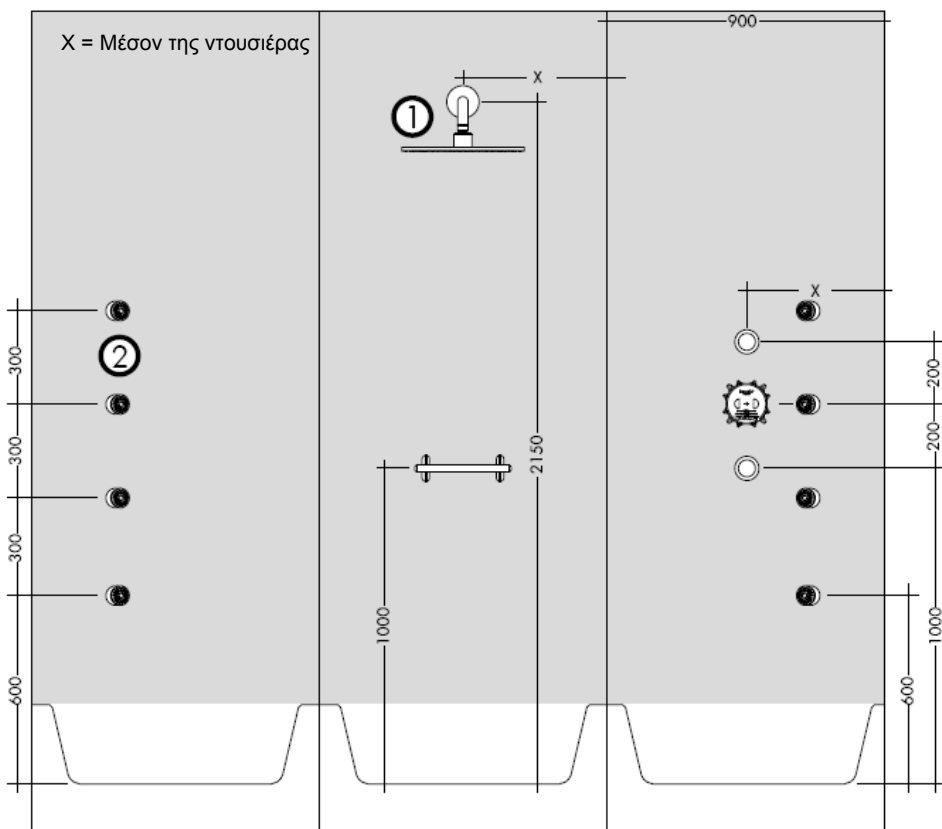

Ενίσχυση τοίχου για στερέωση βραχίονα ντουζιέρας είναι απαραίτητη

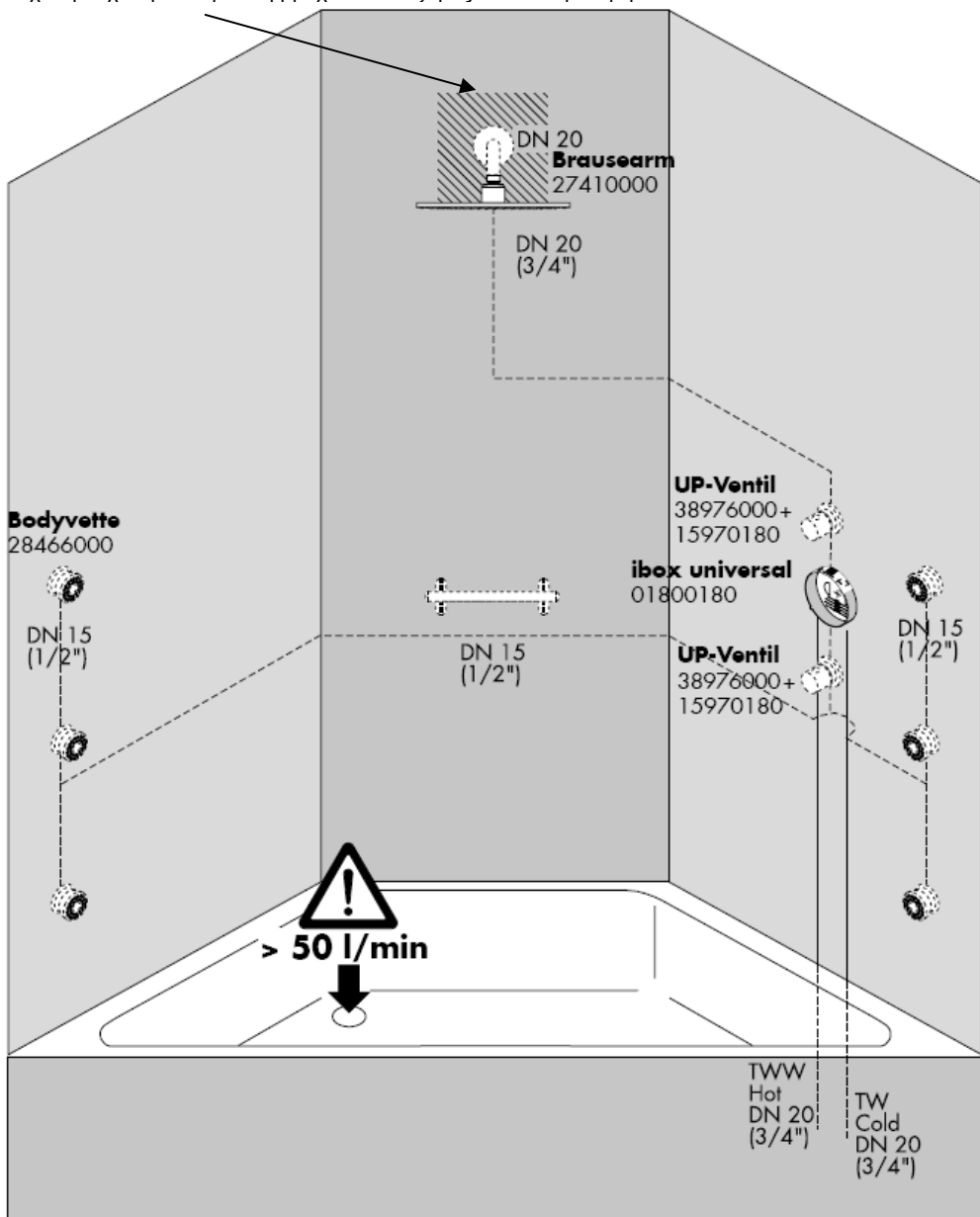

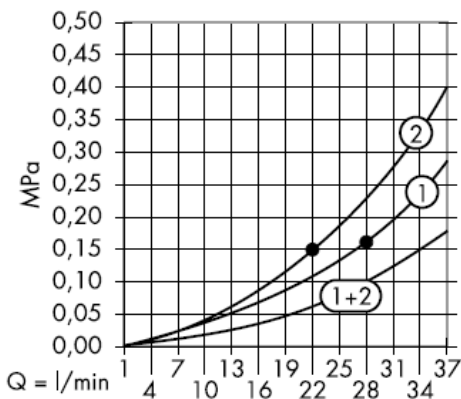

Αυτή η λειτουργία διασφαλίζεται από το σημείο κι έπειτα

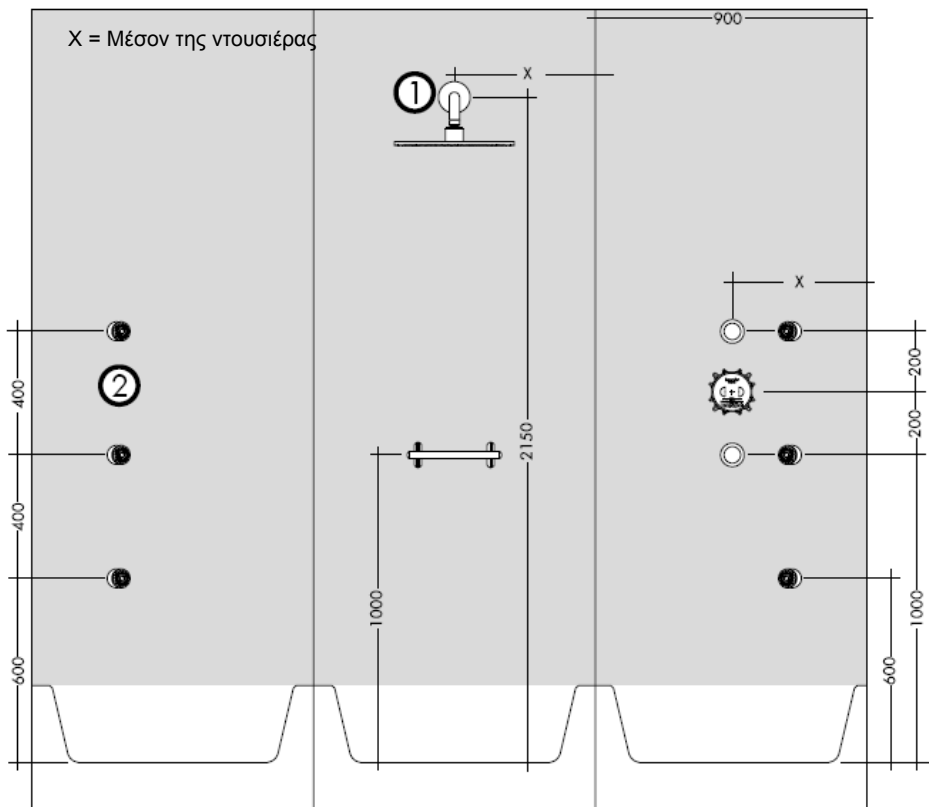

Ενίσχυση τοίχου για στερέωση βραχίονα ντουζιέρας είναι απαραίτητη

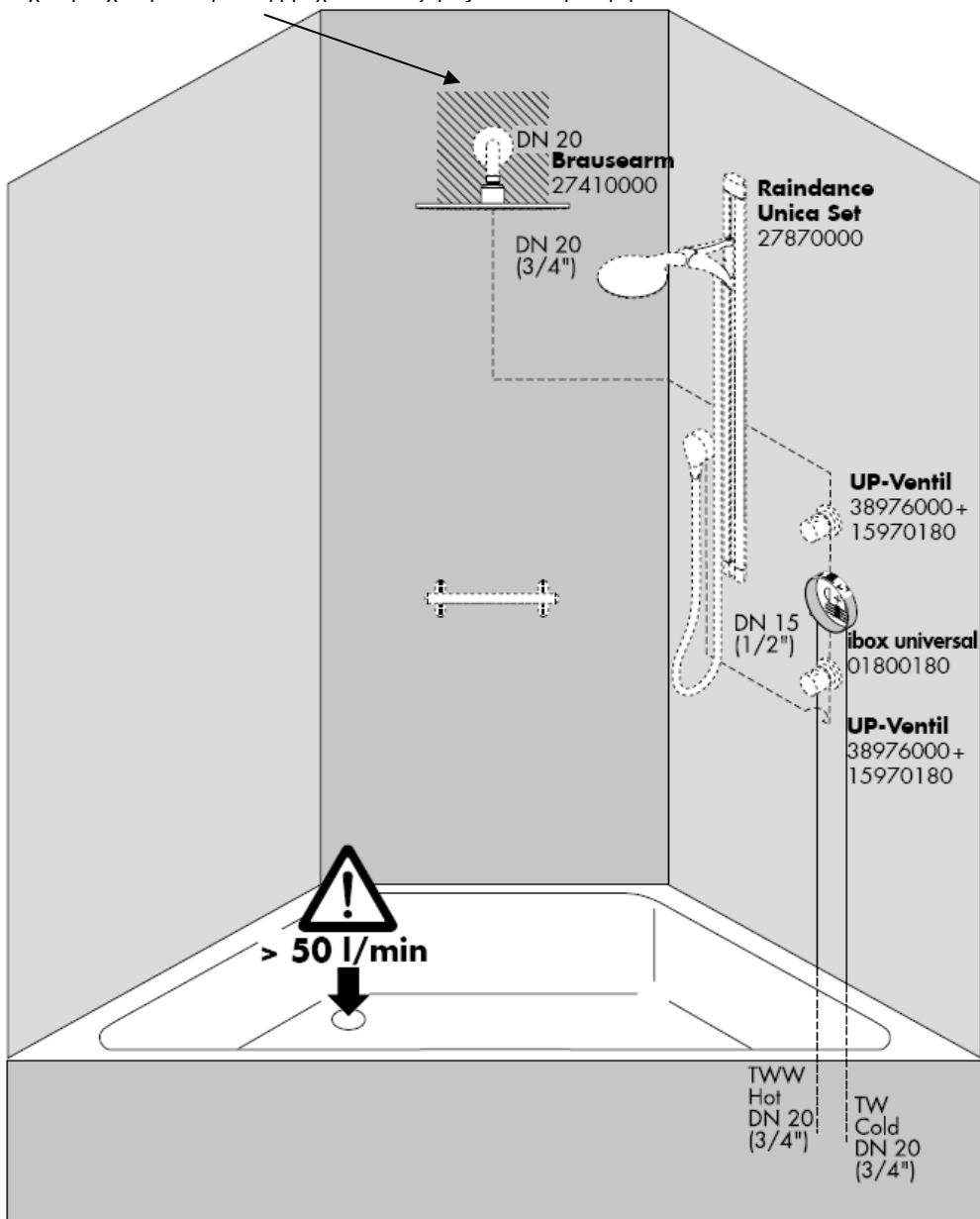

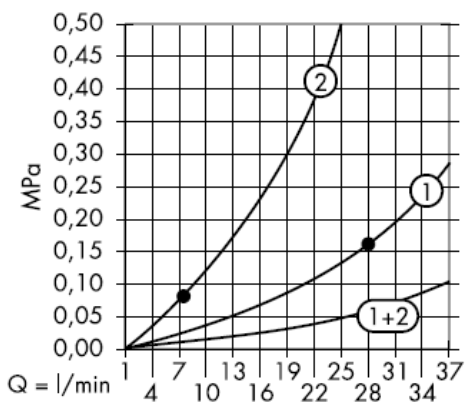

Αυτή η λειτουργία διασφαλίζεται από το σημείο κι έπειτα

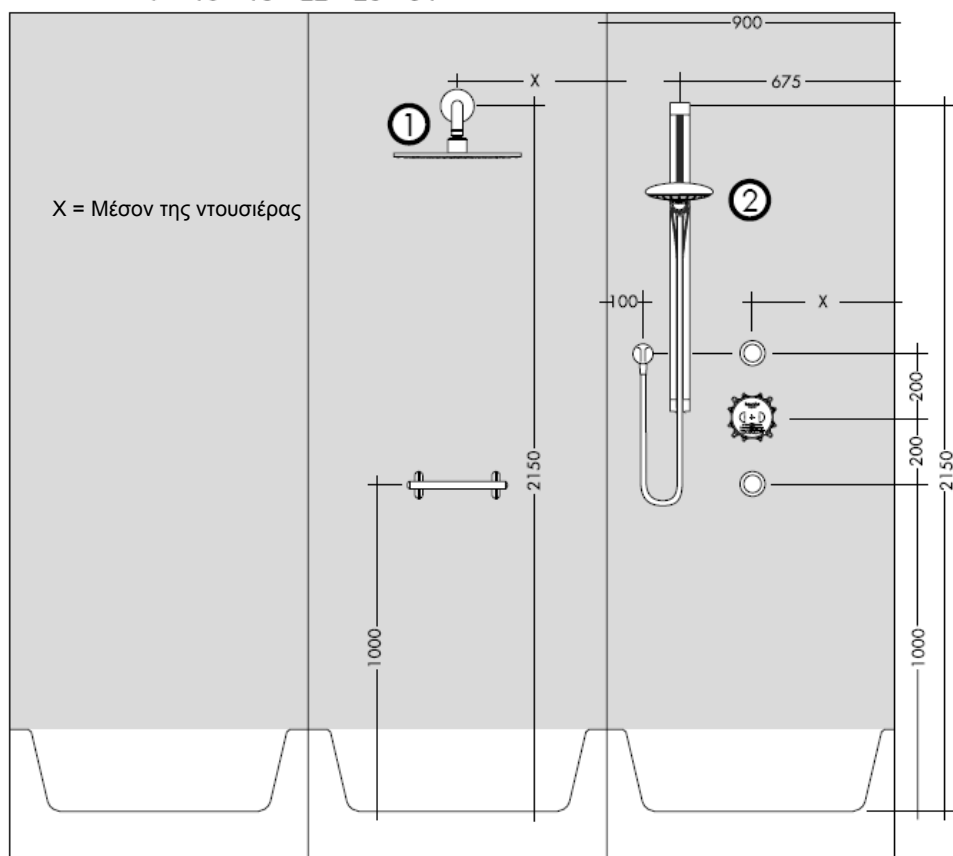

Ενίσχυση τοίχου για στερέωση βραχίονα ντουζιέρας είναι απαραίτητη

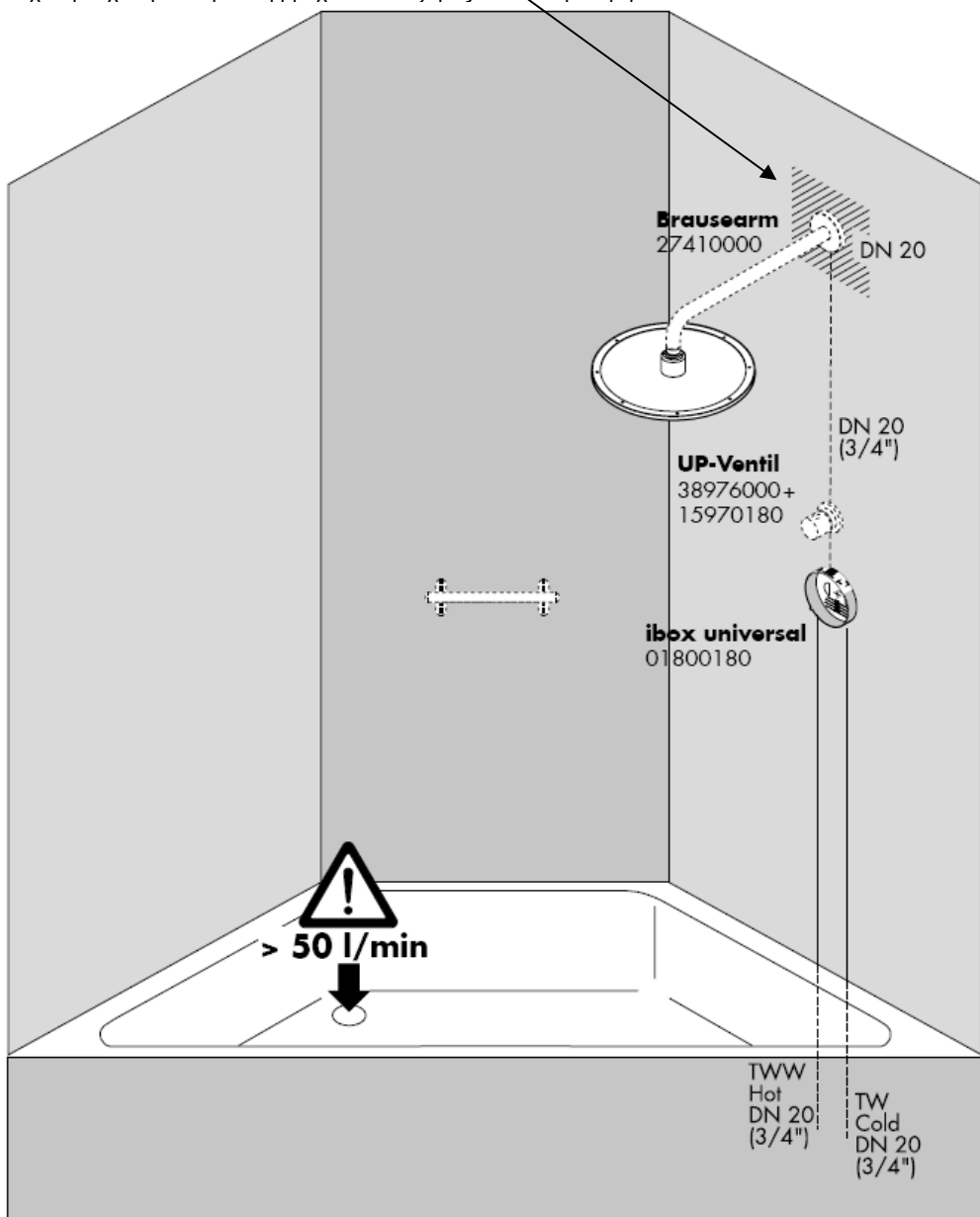

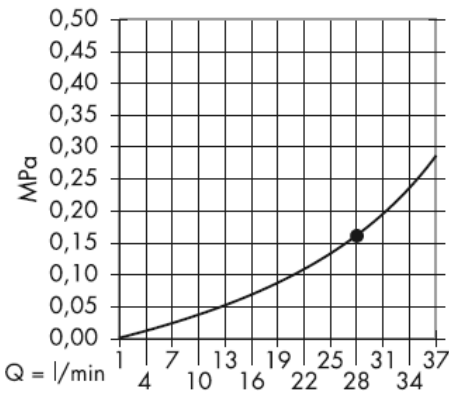

Αυτή η λειτουργία διασφαλίζεται από το σημείο κι έπειτα

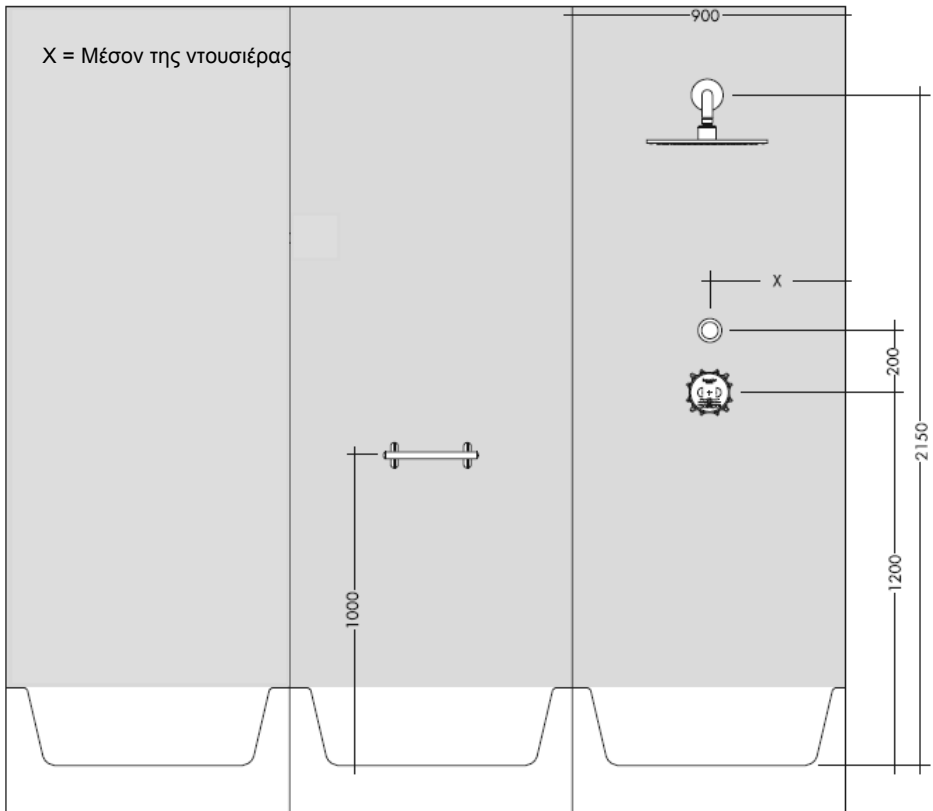

Ενίσχυση τοίχου για στερέωση βραχίονα ντουζιέρας είναι απαραίτητη

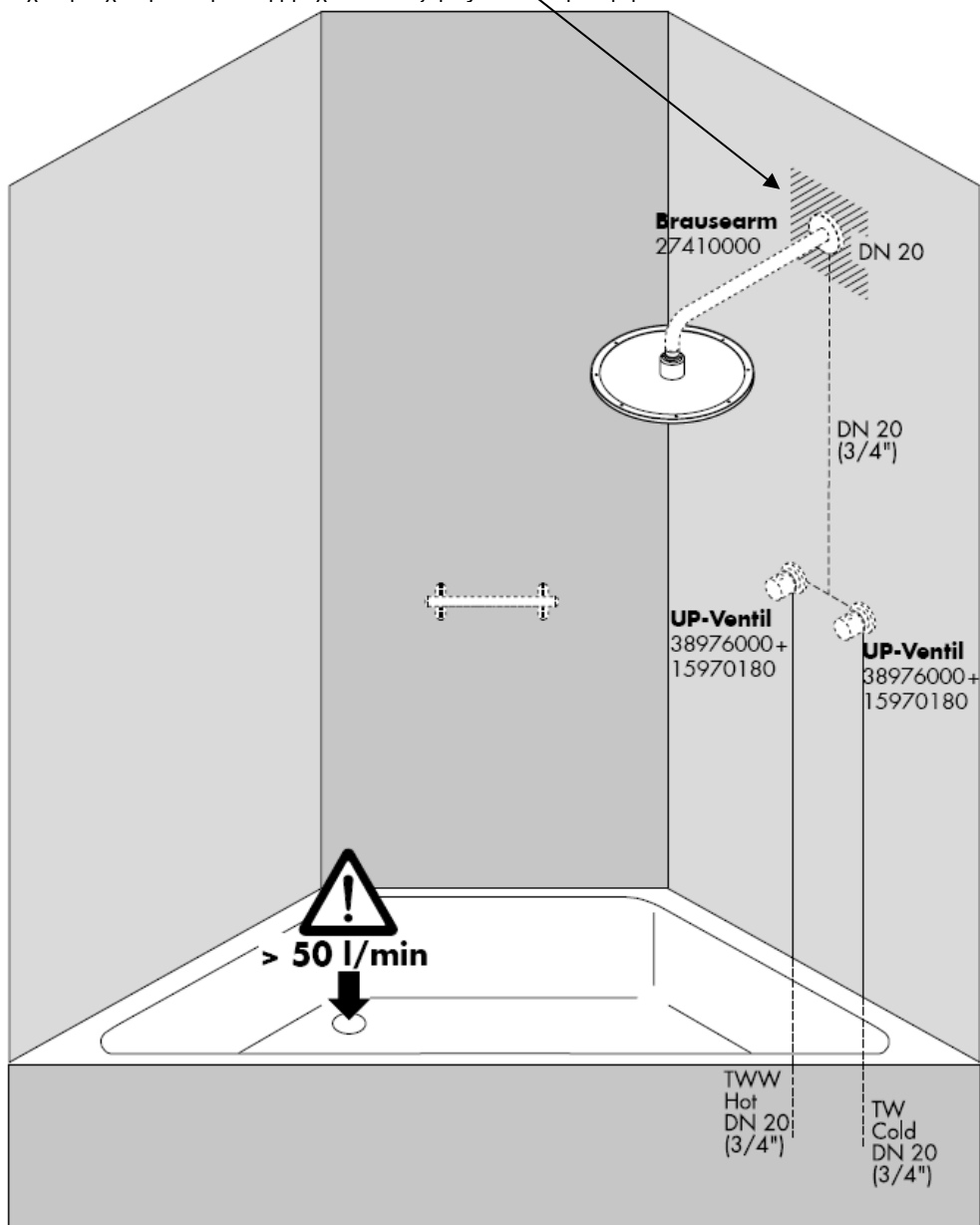

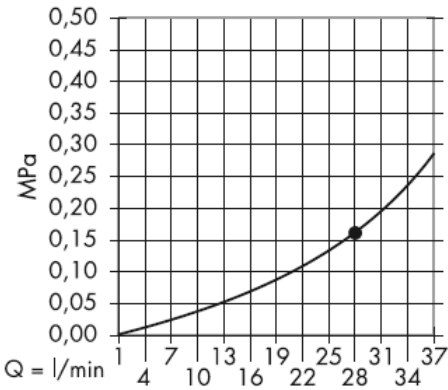

Αυτή η λειτουργία διασφαλίζεται από το σημείο κι έπειτα

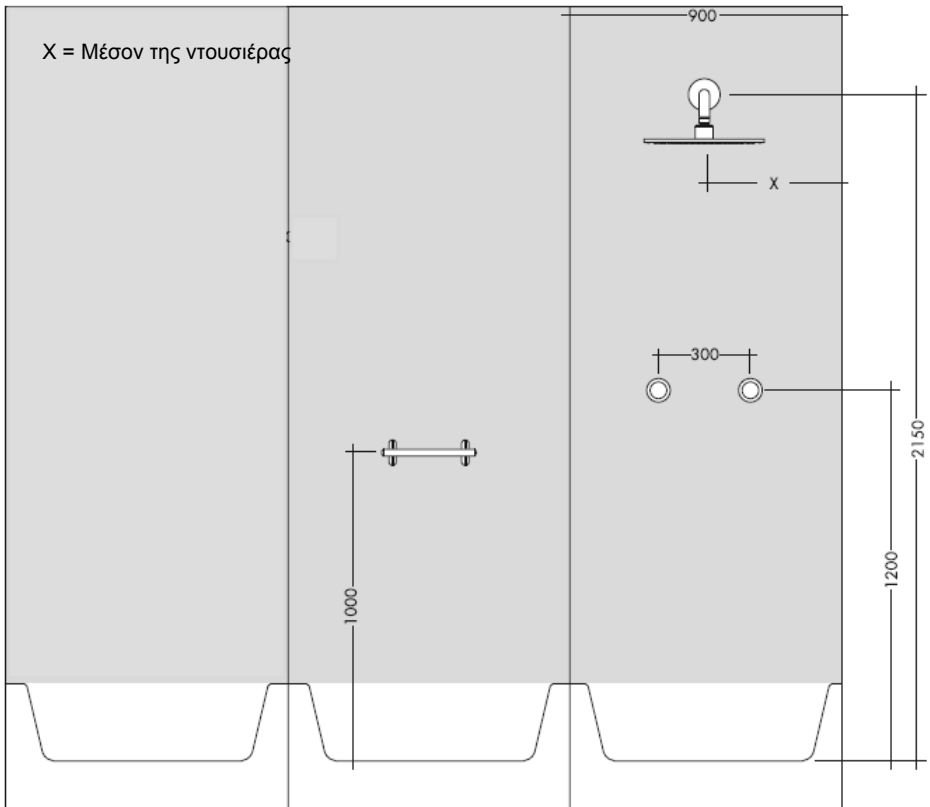

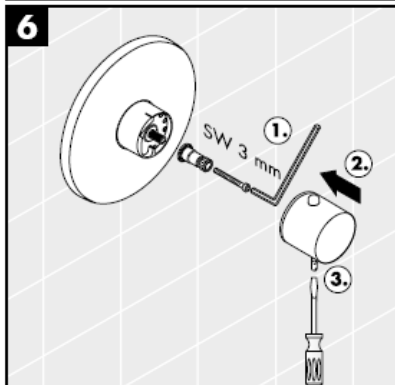
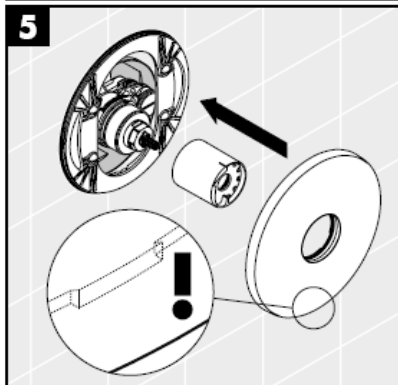
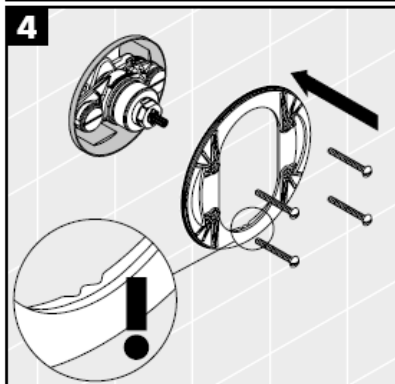
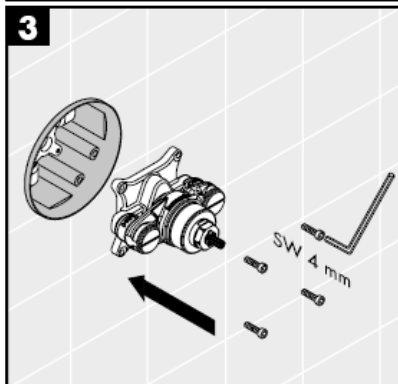
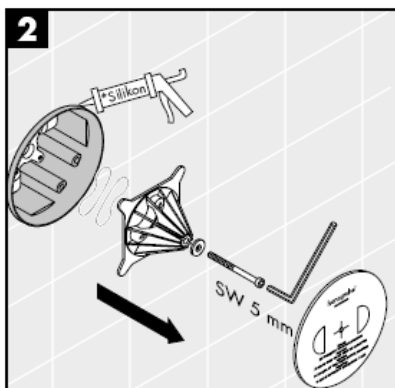
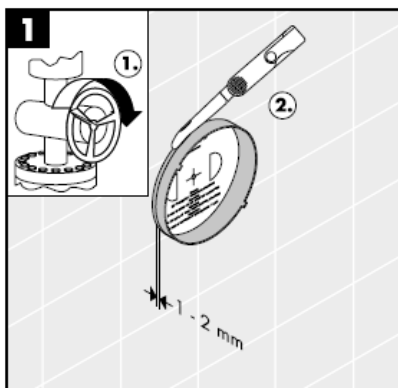

Σιλικόνη (δίχως οξικό οξύ!)

Χάρη στη λειτουργία ασφαλείας Safety Function, είναι δυνατή η προρρύθμιση της επιθυμητής μέγιστης θερμοκρασίας (π.χ. 42 C).

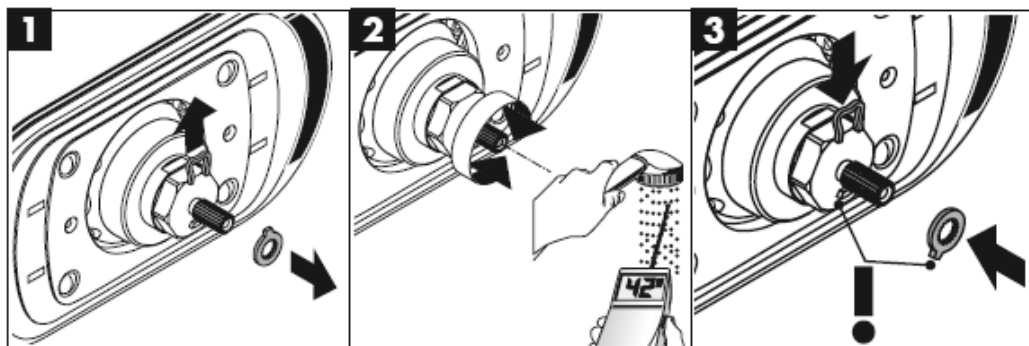

Ρύθμιση

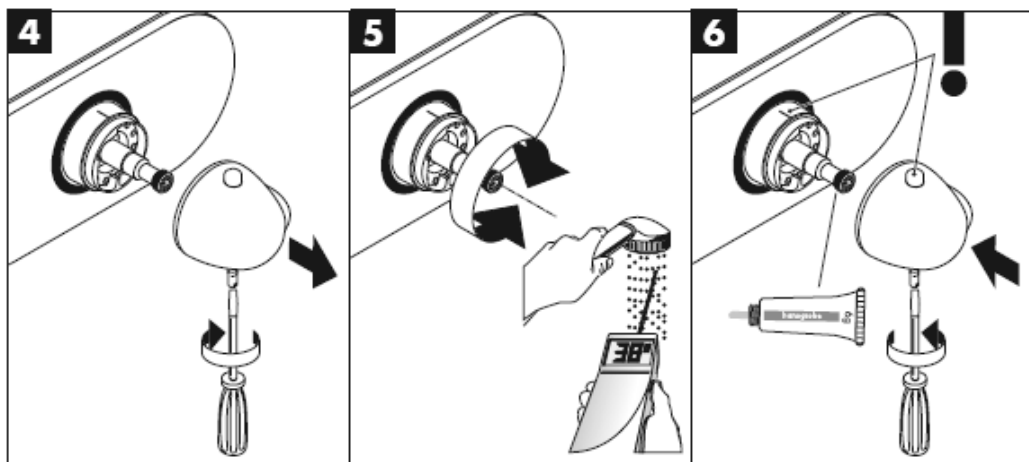



Όταν το ντους λειτουργεί, μαζί με τον βραχίονα έχει βάρος περίπου 10 kg. Για αυτό τον λόγο επιτρέπεται να χρησιμοποιείται υλικό στερέωσης μόνο που ενδείκνυται για την τοιχοποιία! Οι παραδιδόμενες βίδες και ούπατ ενδείκνυται μόνο για μασίφ τοιχοποιία.

Επιτρέπεται η χρήση μόνο υλικών σταθεροποίησης που είναι κατάλληλα για την τοιχοποιία! Οι συνημμένες βίδες και στυλίσκοι είναι κατάλληλοι μόνο για συμπαγή τοιχοποιία.

Η κατανάλωση νερού πρέπει να έχει επαρκείς διαστάσεις.

Η βέλτιστη λειτουργία διασφαλίζεται μόνο σε συνδυασμο τους θερμοστάτες High Flow της Hansgrohe.

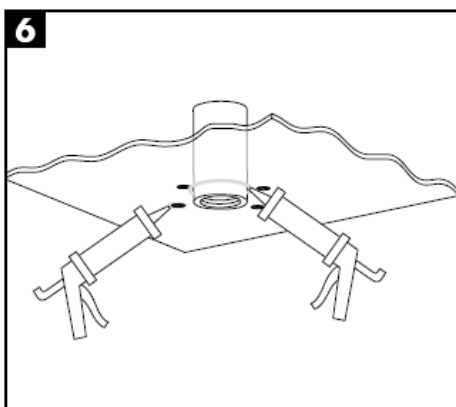
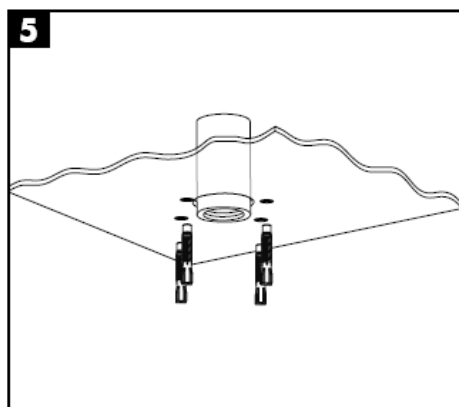
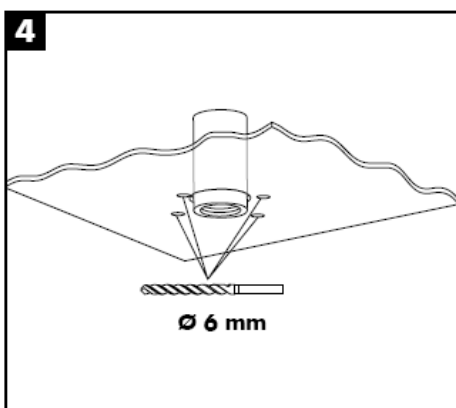
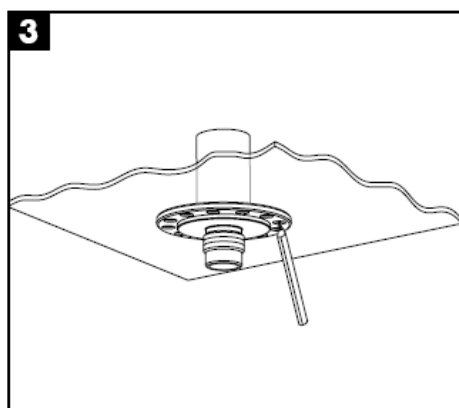
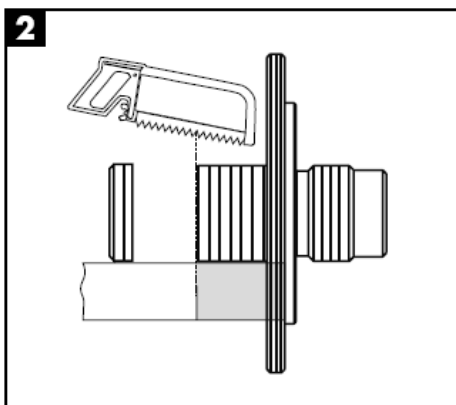
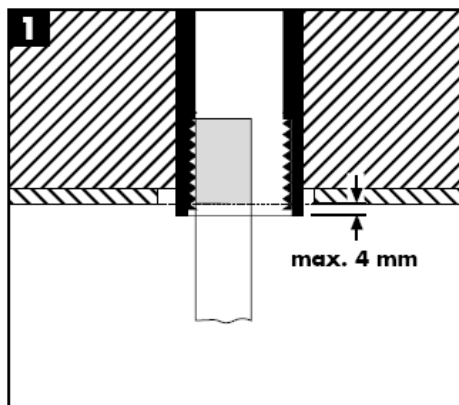

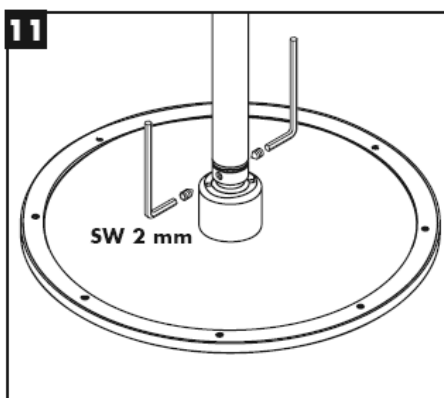
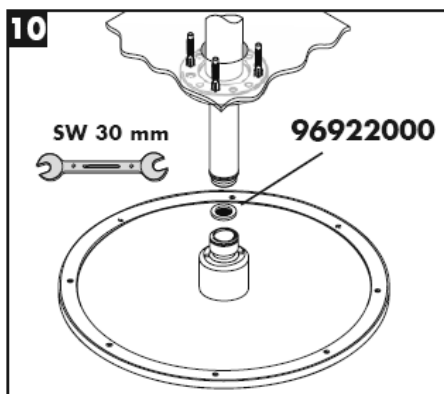
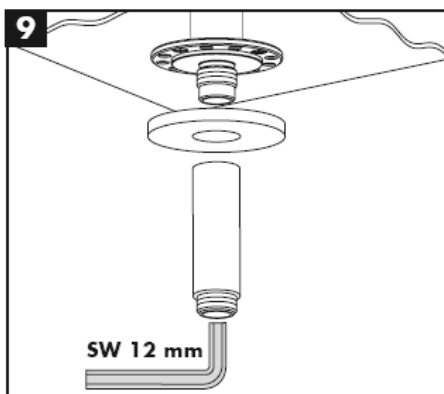
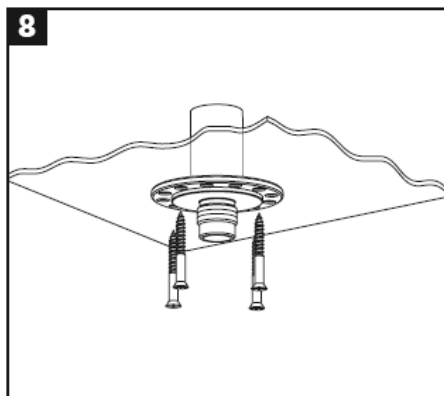
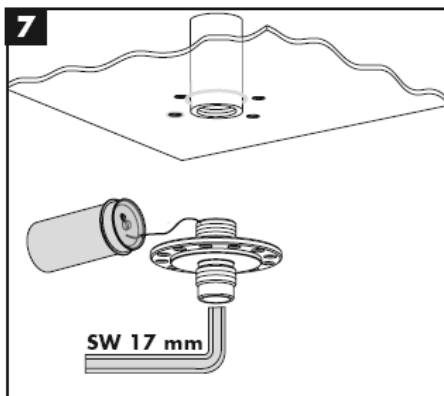

Πρέπει να εγκατασταθεί το παρέμβυσμα φίλτρου που συνοδεύει τον καταιονιστήρα κατά τέτοιο τρόπο, ώστε να αποφεύγονται ρύποι που προέρχονται από το δίκτυο ύδρευσης. Οι ρύποι από το δίκτυο ύδρευσης μπορούν να επηρεάσουν αρνητικά και/ ή να προξενήσουν ζημιά στα λειτουργικά τμήματα του καταιονιστήρα (ντους). Τέτοιου είδους ζημίες δεν καλύπτονται από την εγγύηση Hansgrohe.

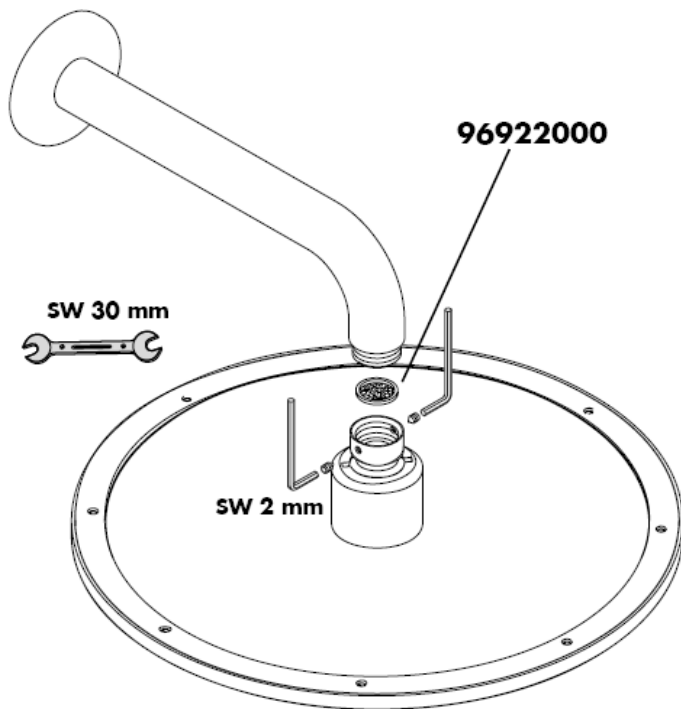

Συναρμολόγηση

Προσοχή! Η κεντρική βάνα πρέπει να τοποθετηθεί, να πλυθεί και να ελεγχθεί με βάση τους ισχύοντες κανόνες υδραυλικής τέχνης!

Ρύθμιση

Είναι απαραίτητη μία διόρθωση, όταν, στο σημείο λήψης, η μετρούμενη θερμοκρασία αποκλίνει από τη ρυθμισμένη στο θερμοστάτη θερμοκρασία. Θα πρέπει να δοθεί προσοχή στα εξής: Περιστρέψτε τη λαβή με την κλίμακα, μέχρις ότου να εξέρχεται νερό στο σημείο λήψης σε θερμοκρασία 38 °C. Χαλαρώστε τη βίδα της λαβής, τραβήξτε τη λαβή προς τα πίσω, και περιστρέψτε μέχρι τη θέση των 38 °C. Εξάγετε τη λαβή και σφίξτε γερά τη βίδα της λαβής (βλ. σελ. 22).

Διάταξη περιορισμού θερμοκρασίας

Το πεδίο της θερμοκρασίας περιορίζεται από τη διάταξη φραγής ασφαλείας στους 38 (προστασία από εγκαύματα). Εάν είναι επιθυμητή μία μεγαλύτερη θερμοκρασία, τότε μπορεί να υπερβληθεί η φραγή των 38 με το πάτημα του πλήκτρου ασφαλείας.

Safety Function (Λειτουργία ασφαλείας)

Χάρη στη λειτουργία ασφαλείας Safety Function, είναι δυνατή η προρύθμιση της επιθυμητής μέγιστης θερμοκρασίας (π.χ. 42 °C). βλ. Σελίδα 21.

Τεχνικά Χαρακτηριστικά

Λειτουργία πίεσης: max. 1 MPa
 Συνιστώμενη λειτουργία πίεσης: 0,1 – 0,5 MPa
 Πίεση ελέγχου: 1,6 MPa
 (1 MPa = 10 bar = 147 PSI)
 Θερμοκρασία ζεστού νερού: max. 80° C
 Συνιστώμενη θερμοκρασία ζεστού νερού: 65° C
 Κατανάλωση νερού: ca. 58 l/min 0,3 MPa

Συντήρηση

Οι θερμοστάτες δεν χρειάζονται ειδική συντήρηση. Οι βαλβίδες αντεπιστροφής πρέπει να ελέγχονται τακτικά ως προς τη λειτουργία τους, σύμφωνα με τις οδηγίες DIN EN 1717, σε σχέση με τους ισχύοντες εθνικούς ή τοπικούς κανόνες (το ελάχιστο μια φορά το χρόνο, σύμφωνα με το πρότυπο DIN 1988) Με την ευκαιρία αυτή, ελέγξτε τους συλλέκτες ακαθαρσιών, οι οποίοι βρίσκονται επάνω στη μονάδα ρύθμισης MTC (6.1). Μετά τη συναρμολόγηση της μονάδας ρύθμισης MTC (6), να ελέγχετε οπωσδήποτε τη θερμοκρασία εκροής, όπως περιγράφεται στην ενότητα "Ρύθμιση". Ελέγξτε οπωσδήποτε προκαταβολικά, εάν η παροχή νερού είναι ενεργοποιημένη και εάν η θερμοκρασία του νερού στο σημείο λήψης έχει τη μέγιστη τιμή της.

Για να διασφαλίσετε την καλή λειτουργία της μονάδας ρύθμισης, θα πρέπει να ρυθμίζετε το θερμοστάτη από καιρού εις καιρόν σε εντελώς ζεστό ή εντελώς κρύο.

Ανταλλακτικά βλ. Σελίδα 3

1	Λαβή θερμοστάτη	38391000
2	Ροζέττα	96452000
3	Κάλυκας	97439000
4	Βίδες φορέα	96454000
5	Ροζέττα φορέα	96447000
6	Μονάδα ρύθμισης θερμοκρασίας	96633000
7	Φίλτρο συλλογής ακαθαρσιών	97367000
8	Βαλβίδα αντεπιστροφής	96655000
9	Επιμήκυνση 25 mm	13595000
10	Επιμήκυνση 25 mm	13596000

Ελληνικά

Βλάβη	Αιτία	Διόρθωση
Ανεπαρκές νερό	-Η πίεση παροχής δεν είναι επαρκής -Βρώμικο φίλτρο συλλογής ακαθαρσιών της μονάδας ρύθμισης -Βρώμικη στεγανοποιητική σήτα του καταιονιστήρα	-Ελέγξτε την πίεση των αγωγών αποχέτευσης/ύδρευσης -Καθαρίστε τα φίλτρα συλλογής ακαθαρσιών -Καθαρίστε και, εάν χρειαστεί, αλλάξτε τη στεγανοποιητική σήτα μεταξύ καταιονιστήρα και σπιράλ
Η σταυροειδής ροή και το ζεστό νερό ρυθμίζονται με κλειστή βάνα στον αγωγό κρύου νερού, πατώντας τη βάνα ή αντίστροφα	-Βρώμικη/ελαττωματική βαλβίδα αντεπιστροφής	-Αλλάξτε τη βαλβίδα αντεπιστροφής
Η θερμοκρασία εκροής δεν συμφωνεί με τη ρυθμισμένη θερμοκρασία	-Ο θερμοστάτης δεν έχει ρυθμιστεί -Χαμηλή θερμοκρασία ζεστού νερού	-ajustar termostato -Αυξήστε τη θερμοκρασία του ζεστού νερού μεταξύ των 42 C και των 65 C
Δεν είναι δυνατή η ρύθμιση της θερμοκρασίας	-Η μονάδα ρύθμισης θερμοκρασίας είναι βρώμικη ή φέρει άλατα -Εγκαταστήστε το σώμα λειτουργίας περιστρέφοντάς το κατά 180	-Σε νέα εγκατάσταση: Λάθος σύνδεση βασικού κορμού (θα πρέπει: κρύο δεξιά, ζεστό αριστερά) ή ο βασικός κορμός έχει εγκατασταθεί περιστρεφόμενος κατά 180 -Πιεστικό κουμπί ή διάταξη φραγής ασφαλείας χωρίς λειτουργία
Ελαττωματικό ελατήριο	-Καθαρίστε και λιπάνετε ελαφρά, και, εάν χρειαστεί, αλλάξτε το ελατήριο ή/και το πιεστικό κουμπί -Αφαλατωμένο πιεστικό κουμπί	-Καθαρίστε και λιπάνετε ελαφρά, και, εάν χρειαστεί, αλλάξτε το ελατήριο ή/και το πιεστικό κουμπί -Καθαρίστε και λιπάνετε ελαφρά, και, εάν χρειαστεί, αλλάξτε το ελατήριο ή/και το πιεστικό κουμπί

Σήμα ελέγχου

	P-IX	DVGW	SVGW	WRSA	KIWA	ACS	NF
27070000						X	
27418XXX							
28420000						X	
28435XXX						X	

Καθαρισμός

Απλά τέλεια καθαριότητα: Τα άλατα μπορούν να αφαιρεθούν με μεγάλη ευκολία από τα στόμια.

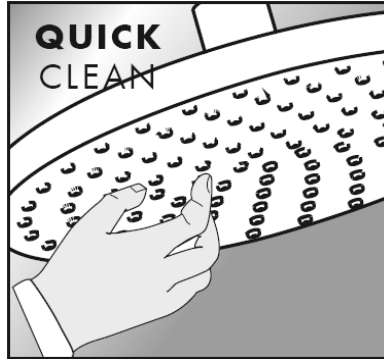

Οδηγία συντήρησης

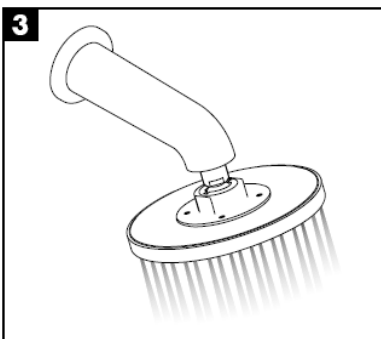
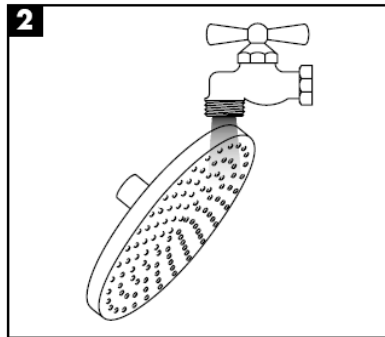
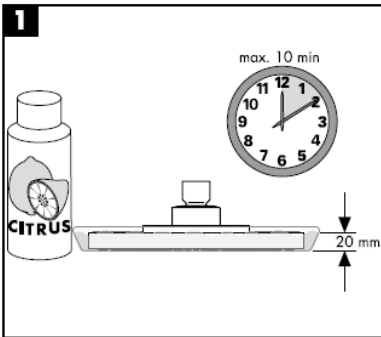

hansgrohe

تعليمات التجميع



27418XXX

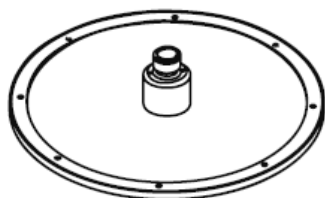

Raindance Royale AIR
28420000

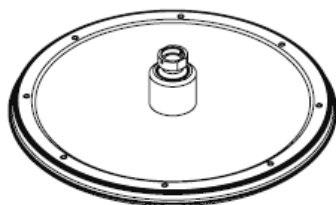

Raindance Royale Classic AIR
28435XXX

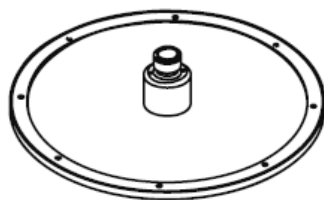

**Raindance Royale
High Flow Set**
27070000

hangrohe

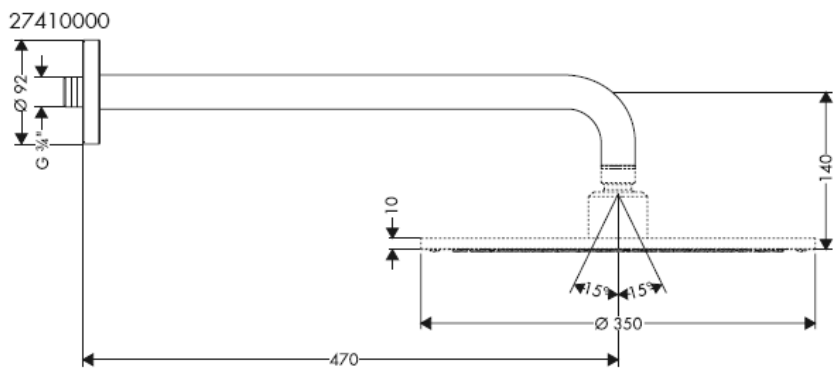
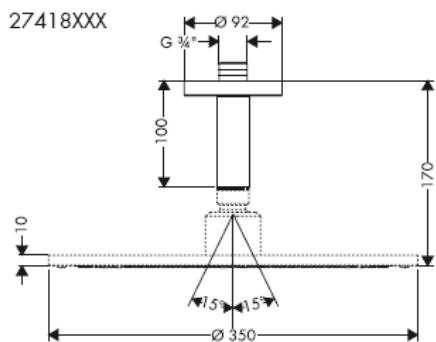
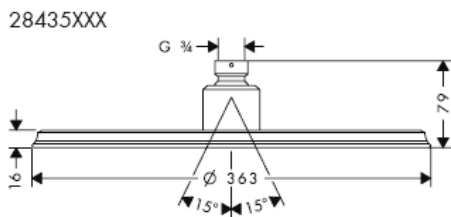
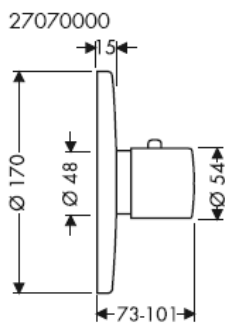
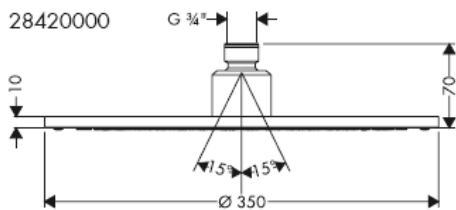

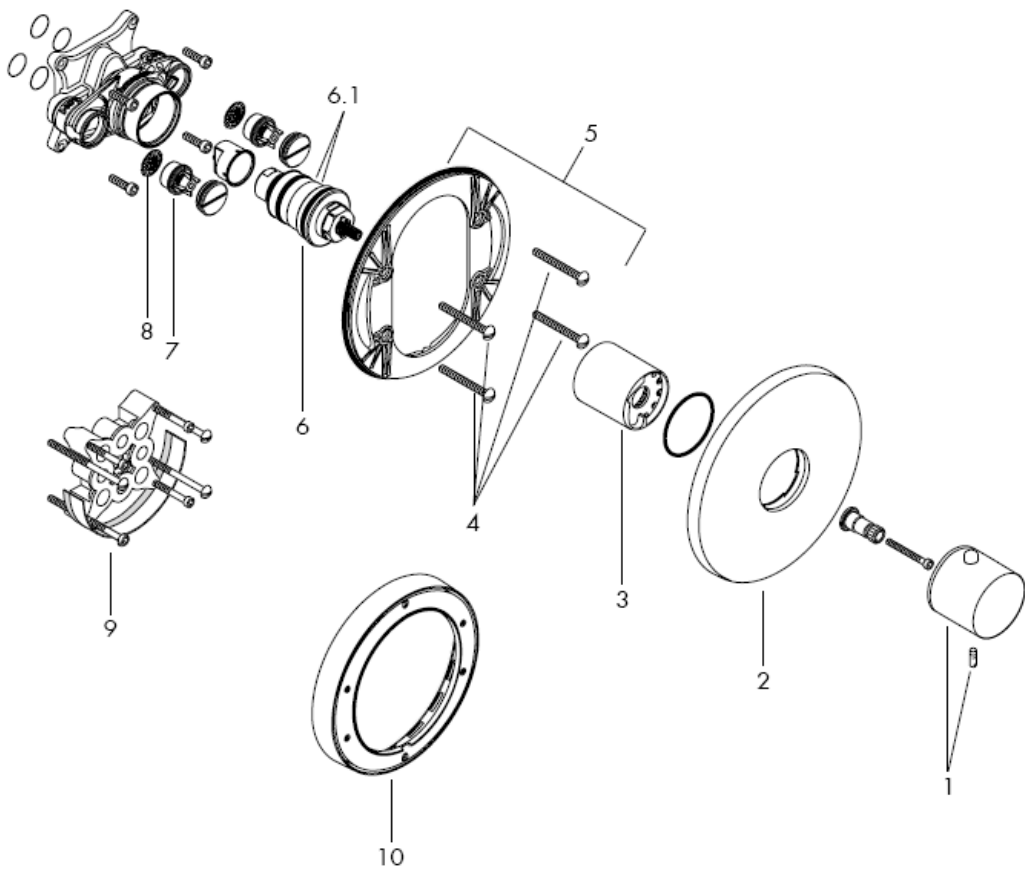

قم بضبط الأبعاد حسب شكل البلاط إذا لزم الأمر.

يجب تدعيم الجدار من أجل تثبيت ذراع الدش بإحكام.

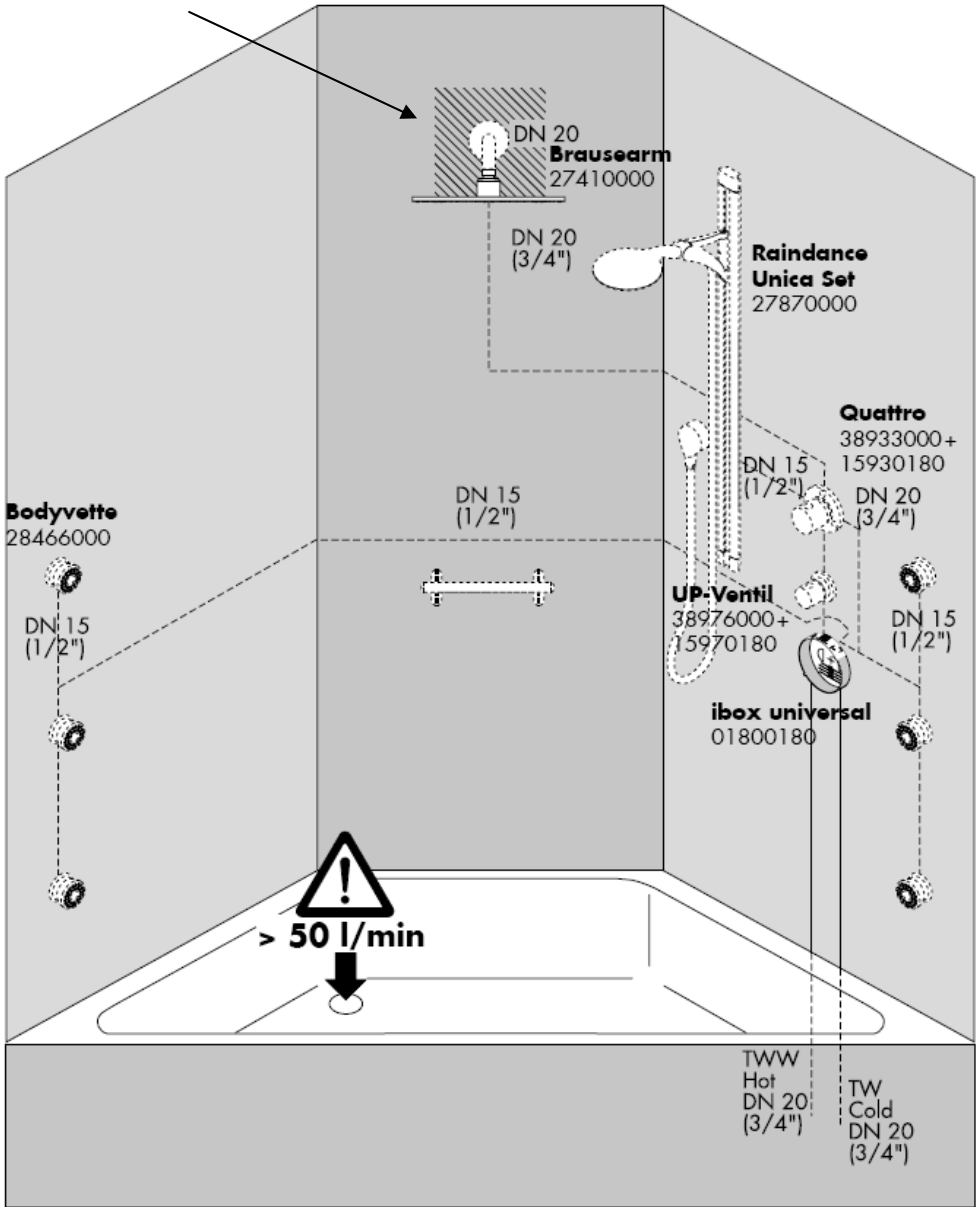

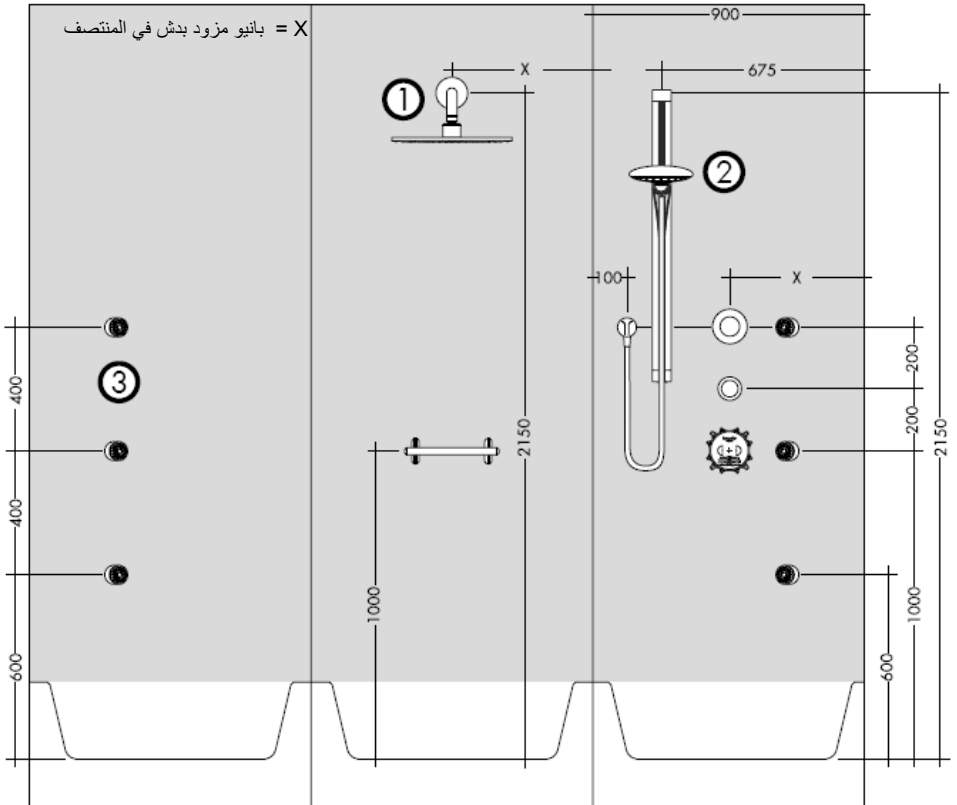
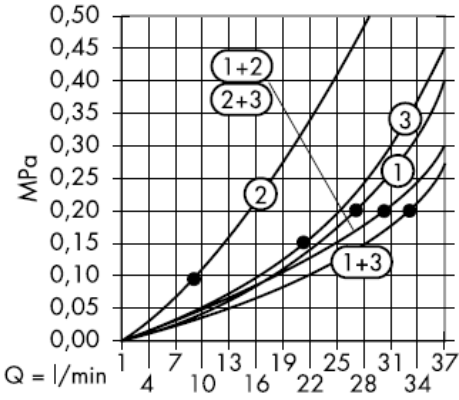

يجب تدعيم الجدار من أجل تثبيت ذراع الدش بالحكام.

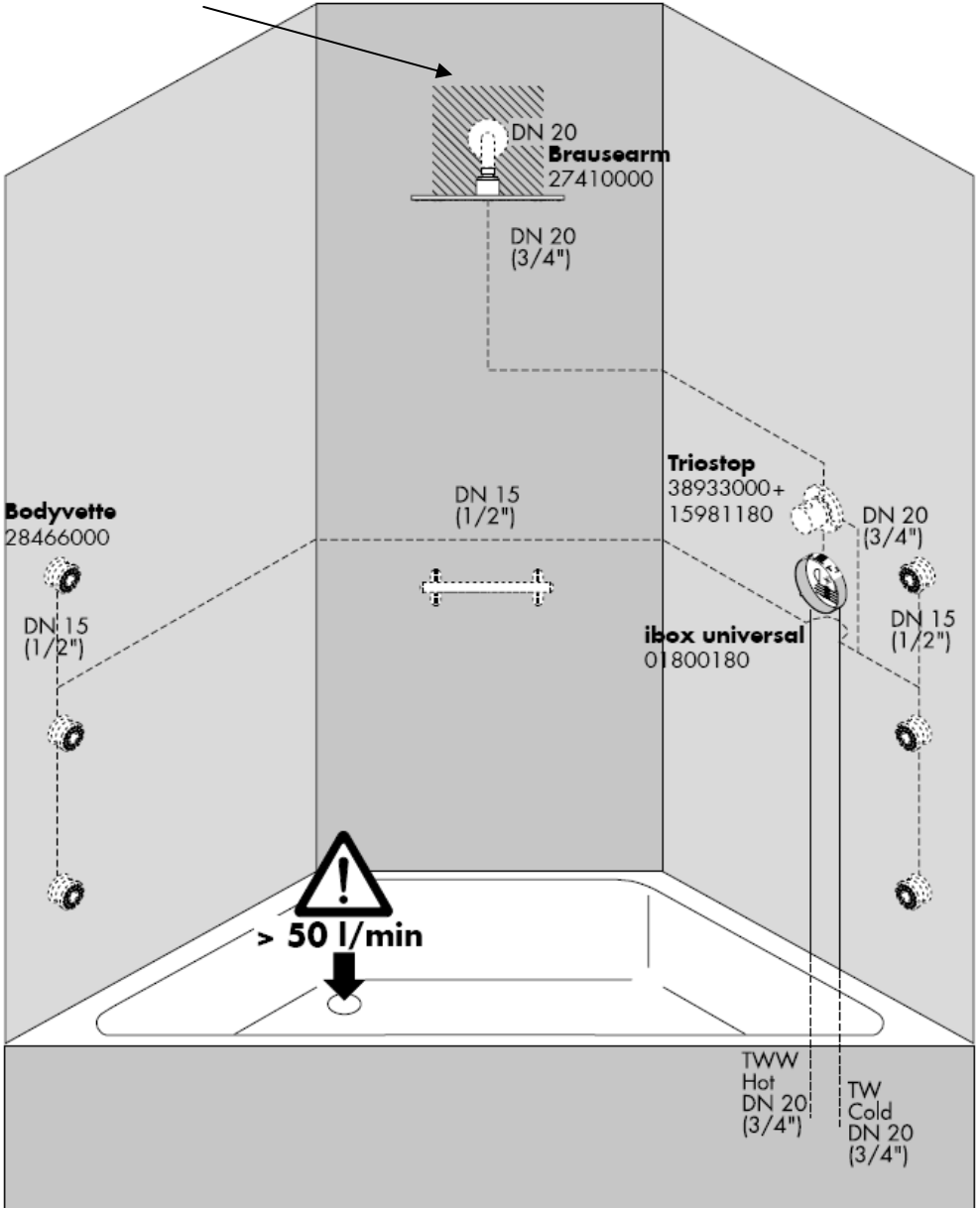

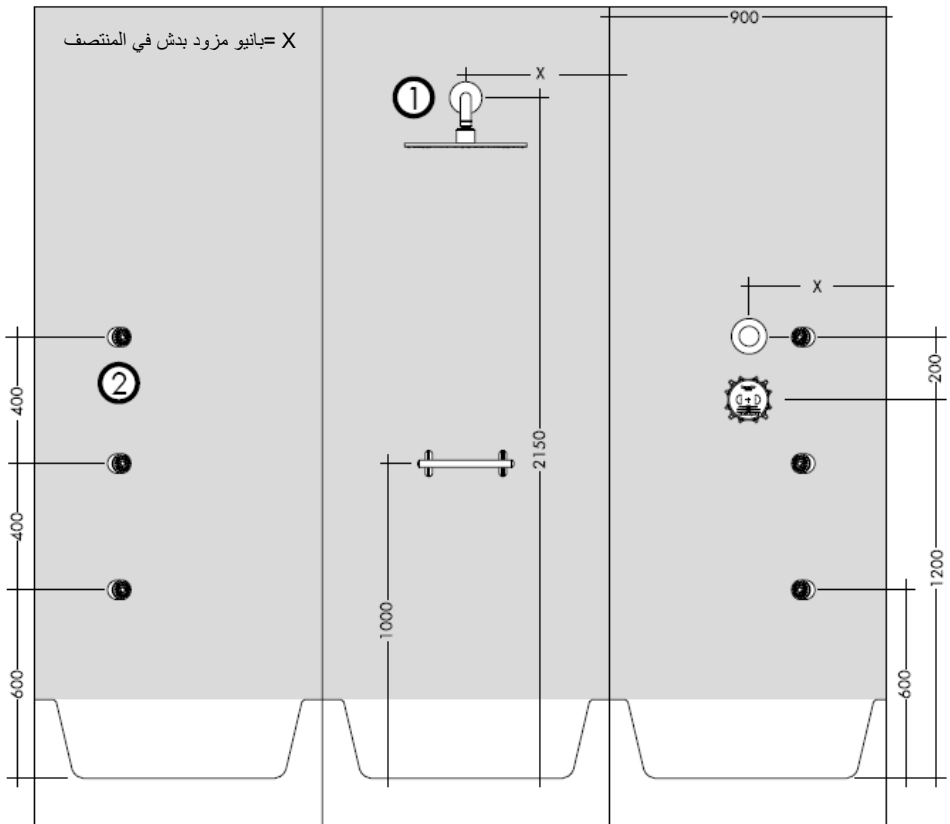
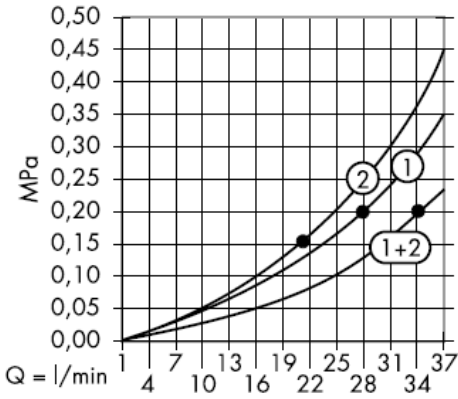

يجب تدعيم الجدار من أجل تثبيت ذراع الدش بإحكام.

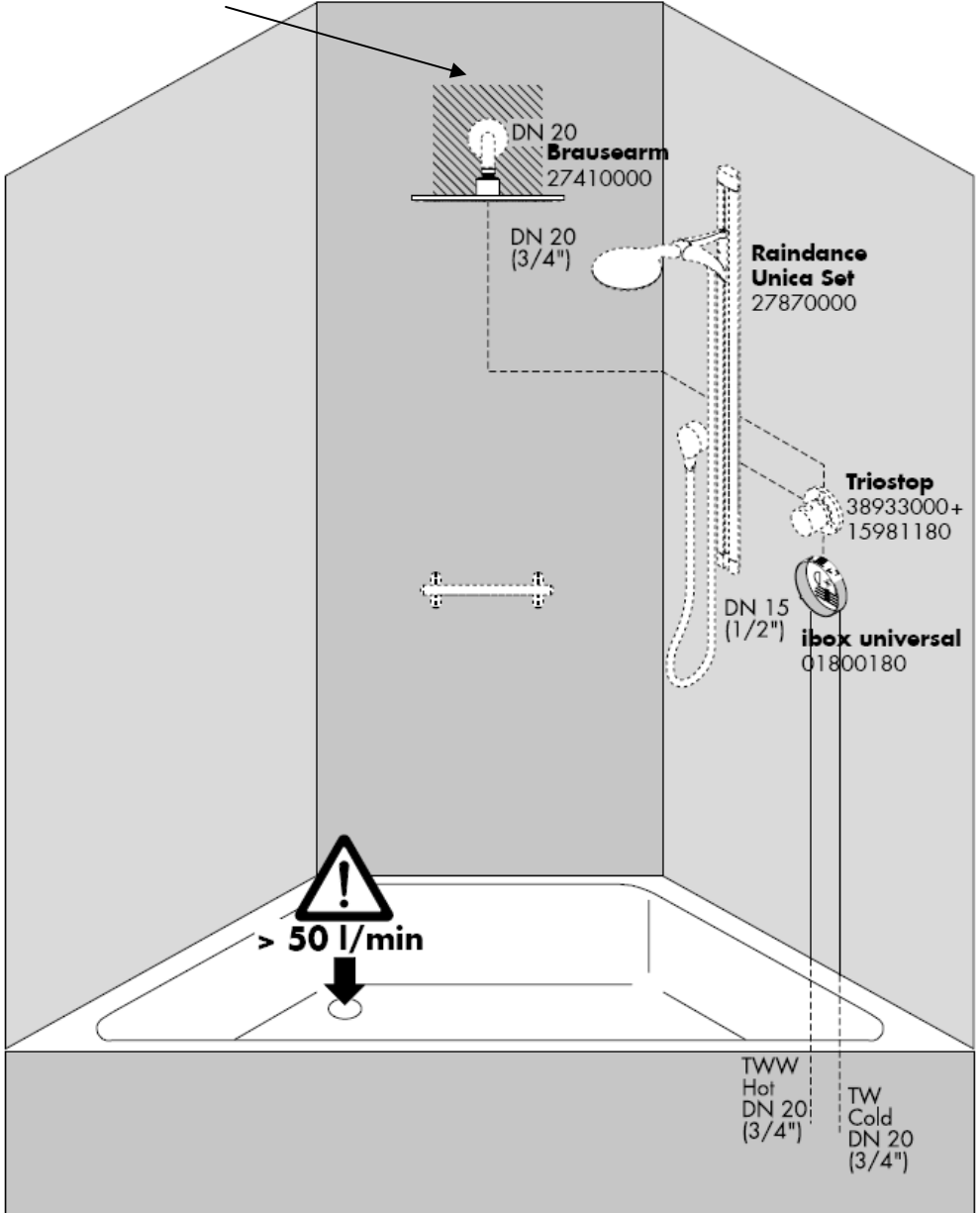

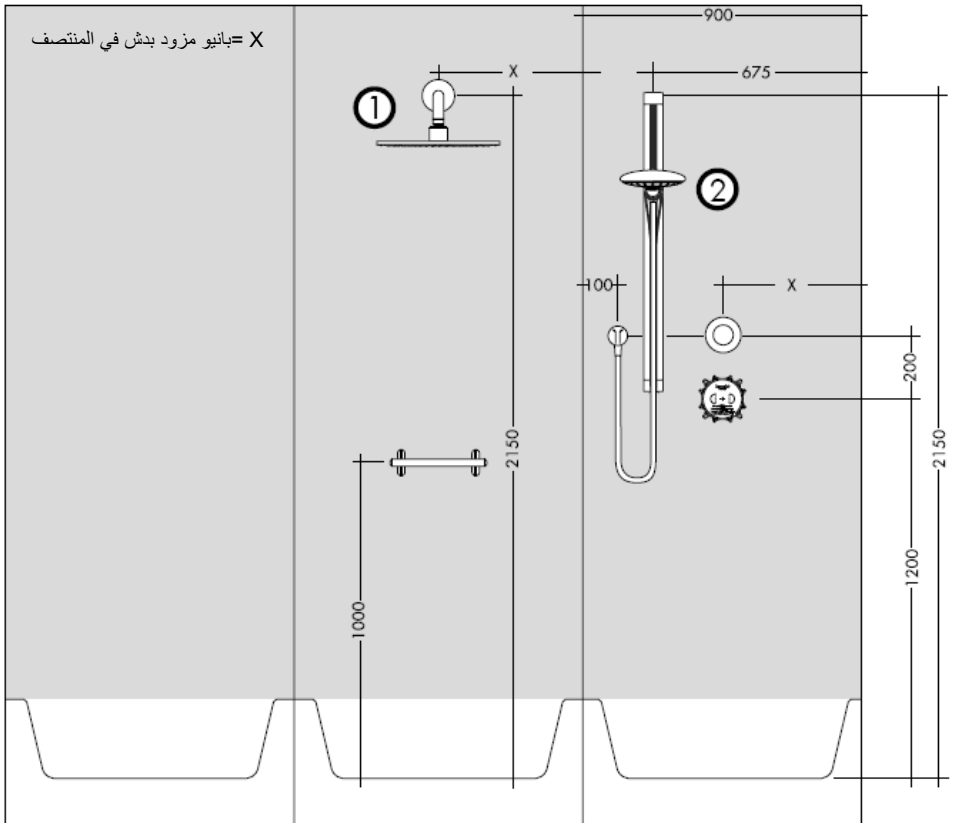
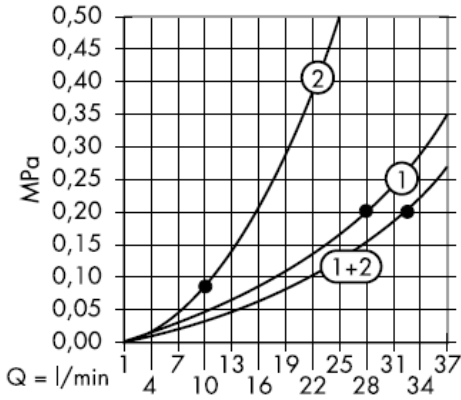

يجب تدعيم الجدار من أجل تثبيت ذراع الدش بإحكام.

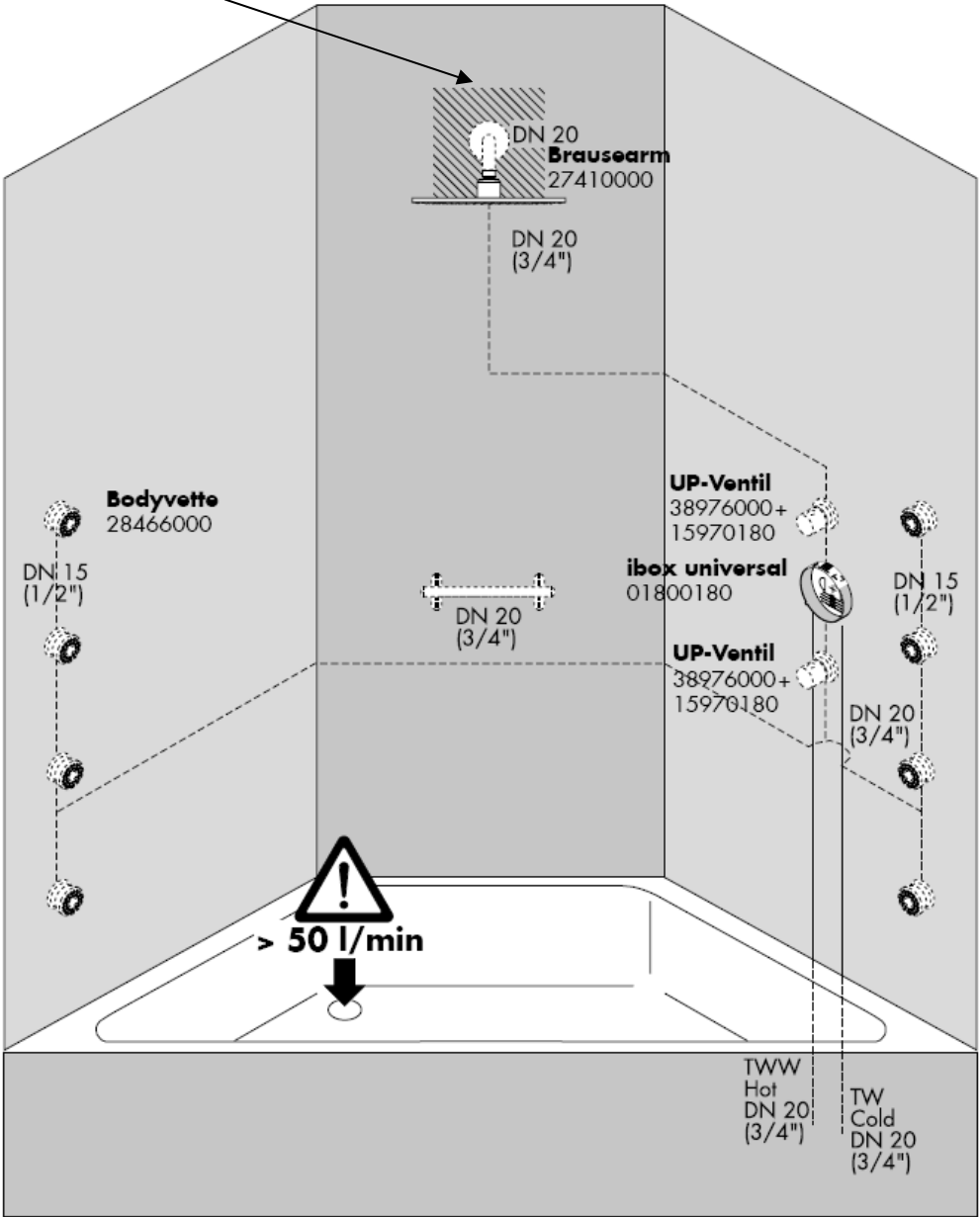

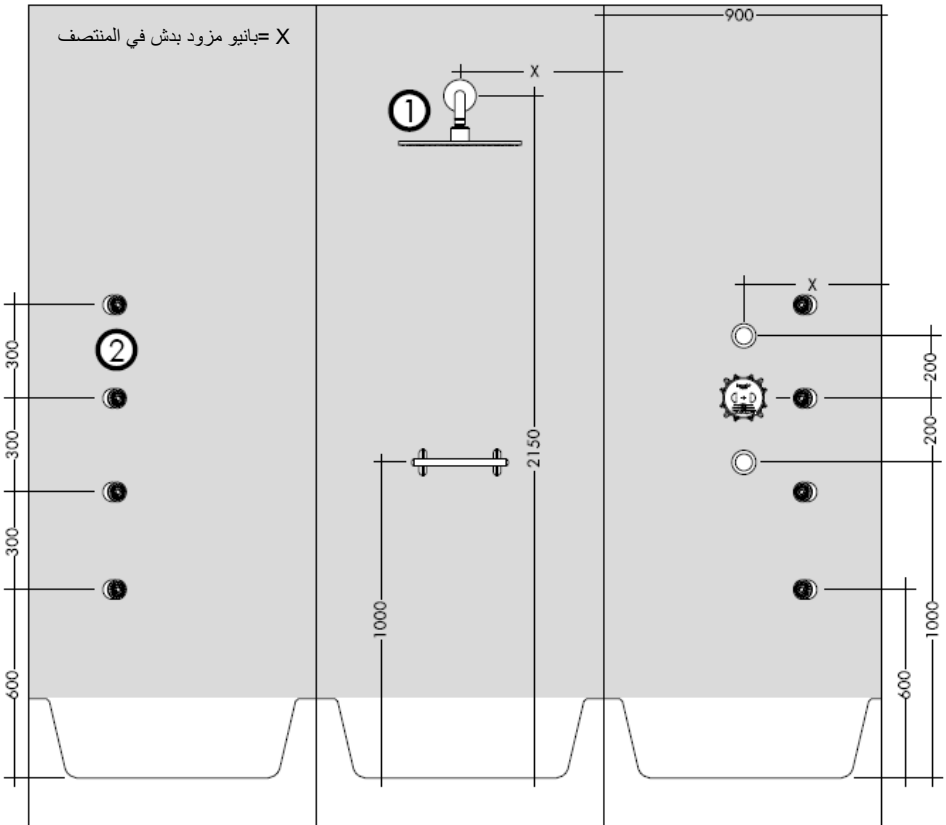
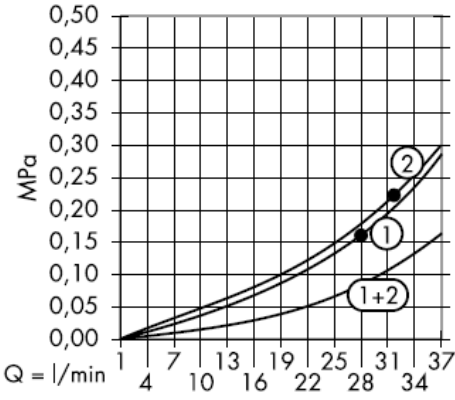

يجب تدعيم الجدار من أجل تثبيت ذراع الدش بالحكام.

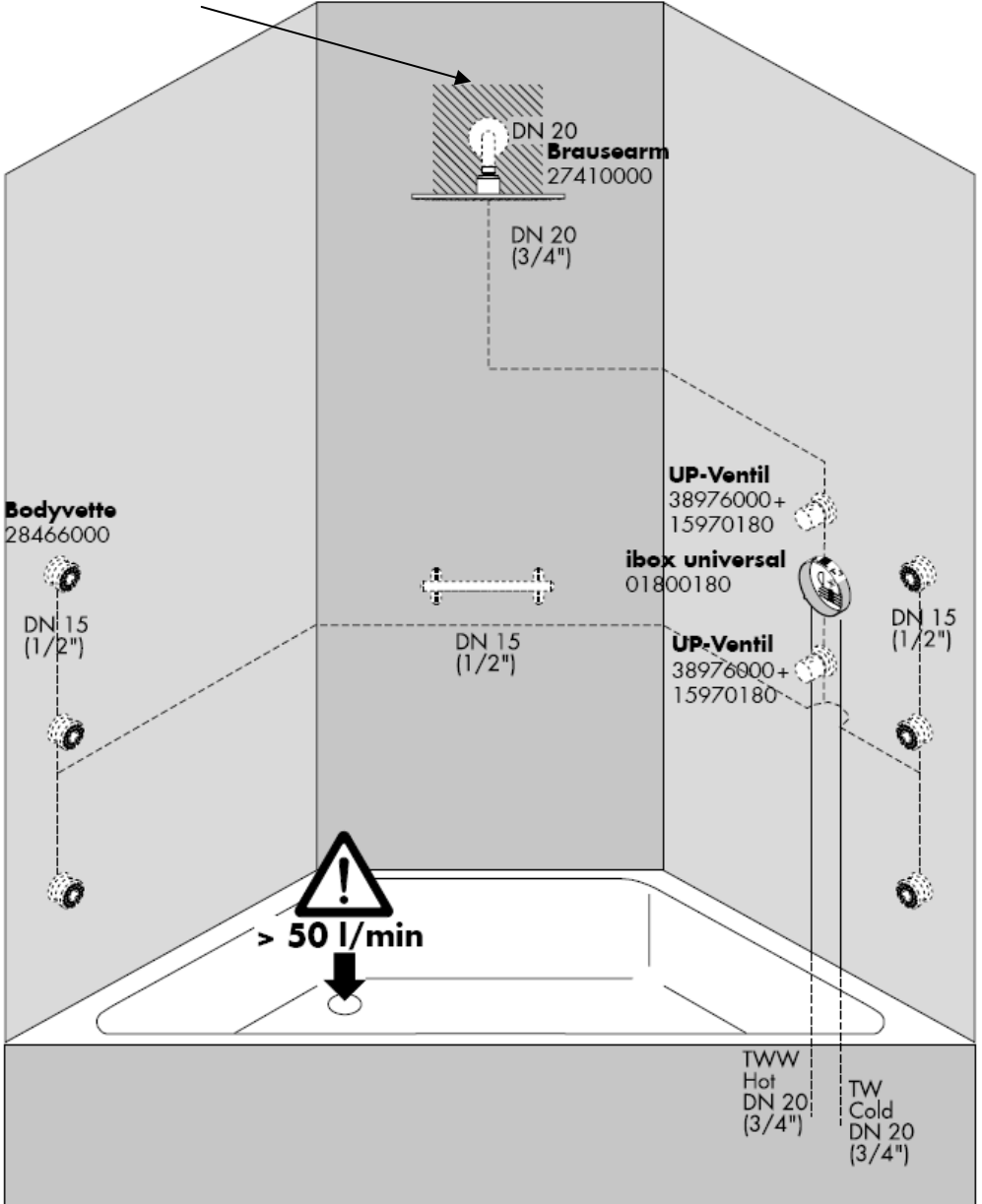

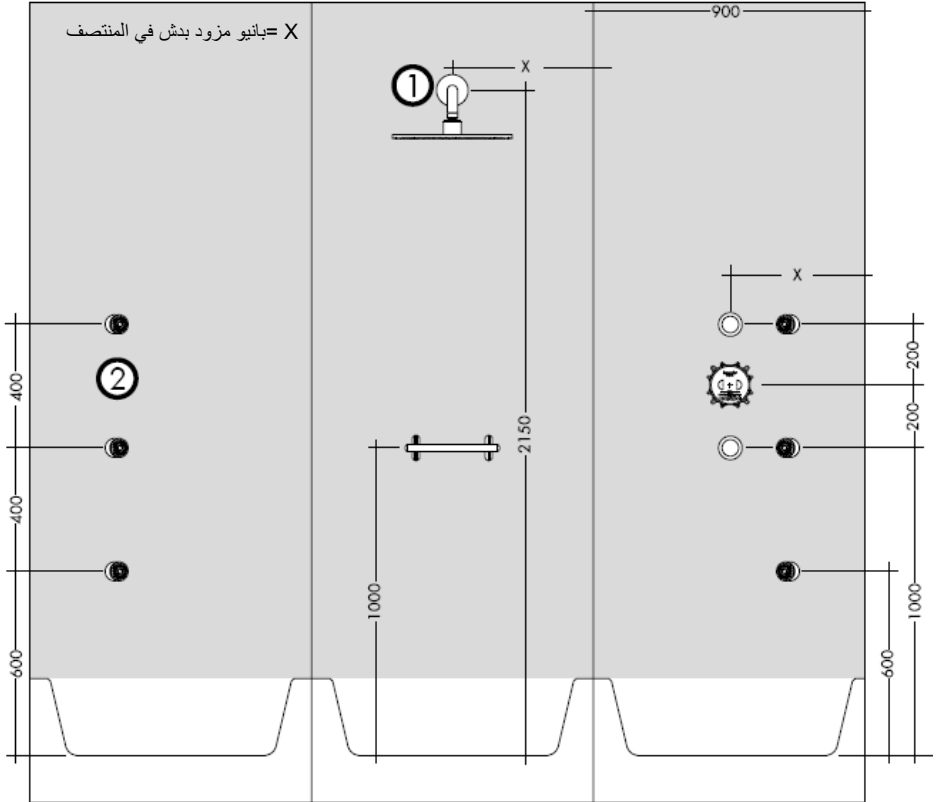
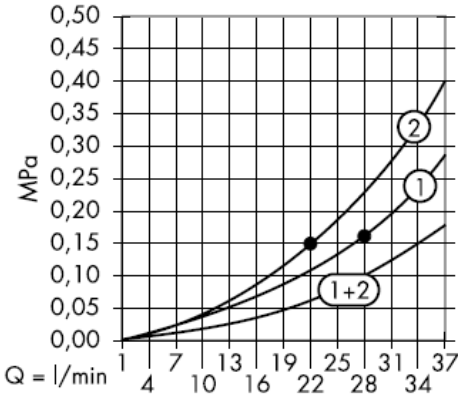

يجب تدعيم الجدار من أجل تثبيت ذراع الدش بإحكام.

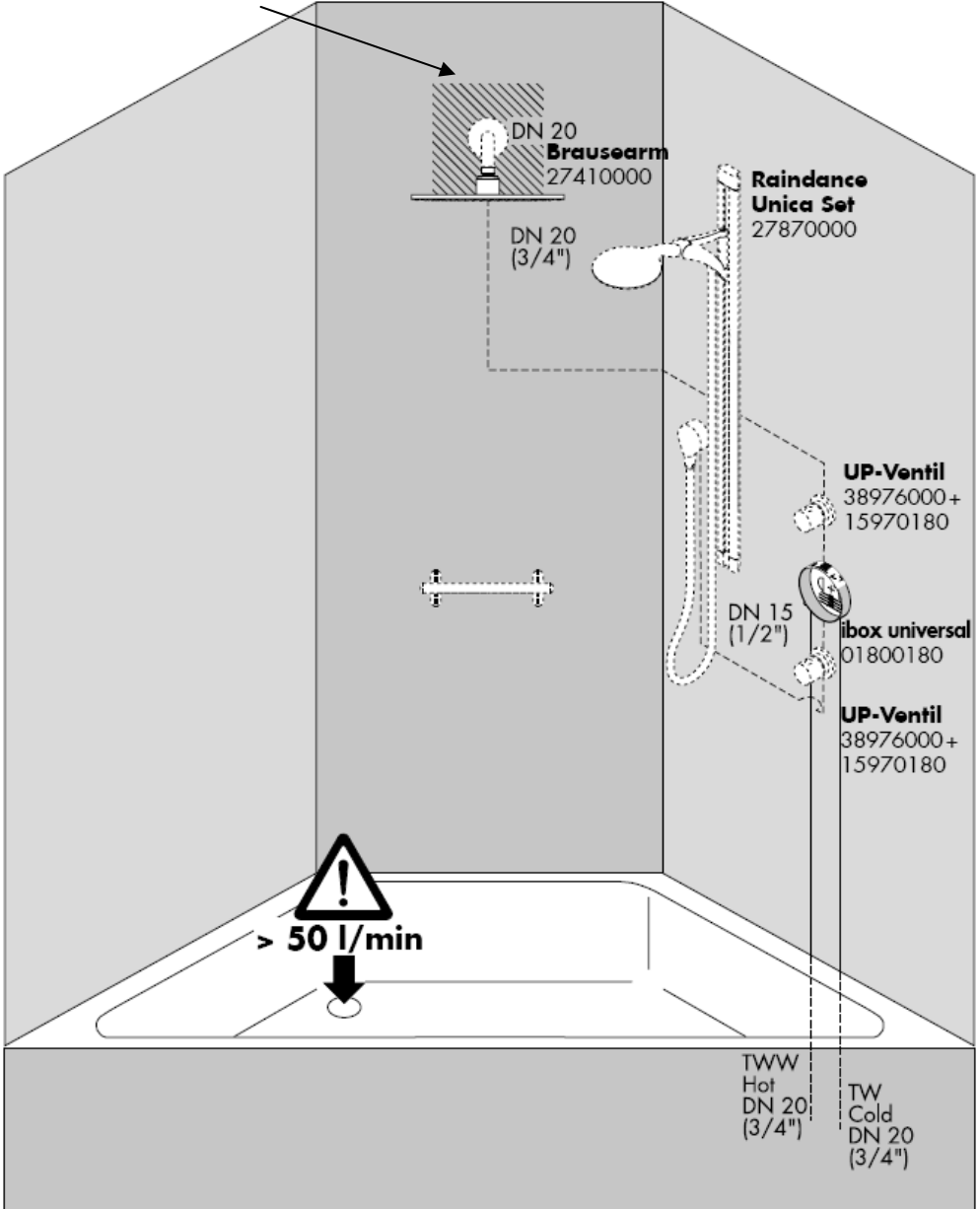

يجب تدعيم الجدار من أجل تثبيت ذراع الدش بالحكام.

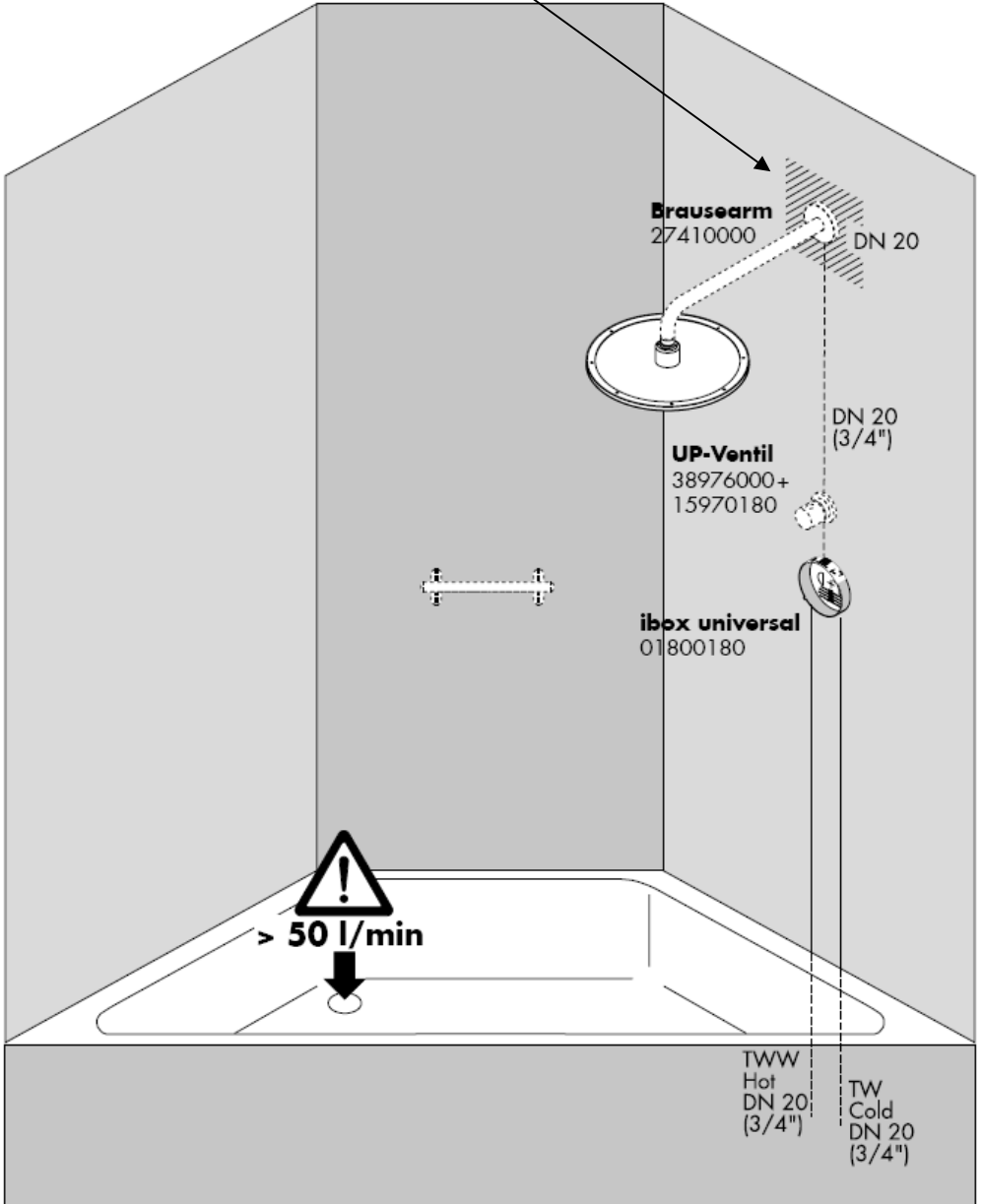

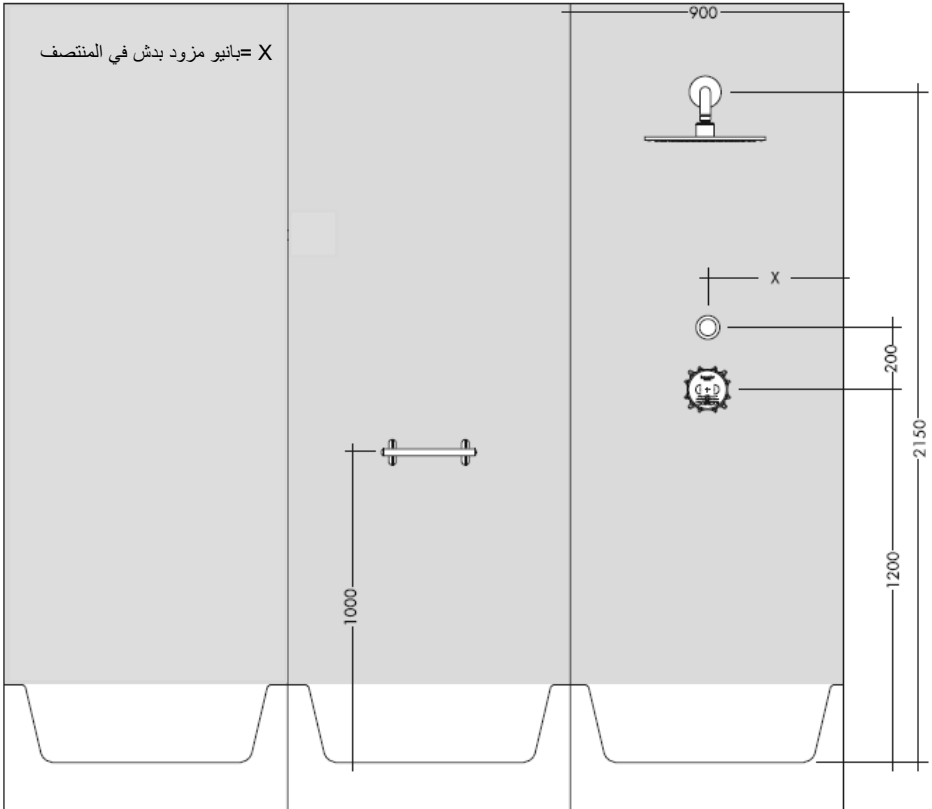
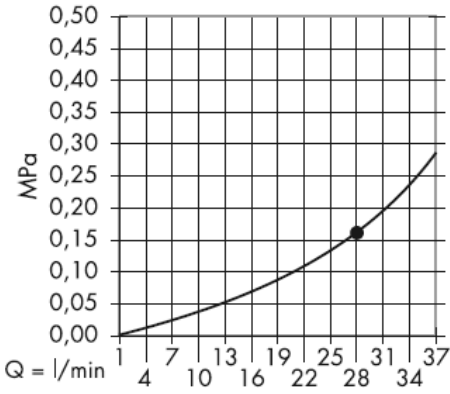

يجب تدعيم الجدار من أجل تثبيت ذراع الدش بإحكام.

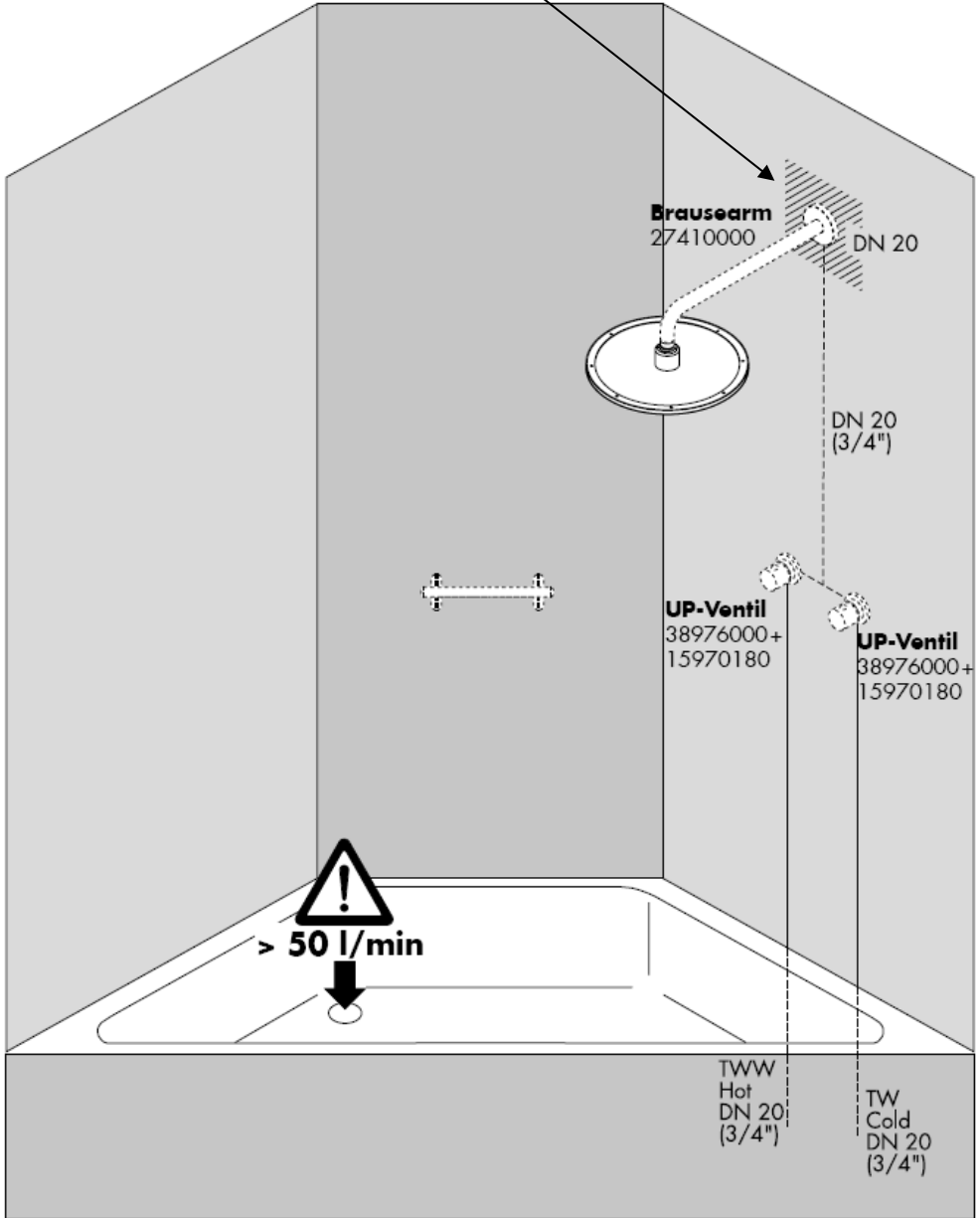

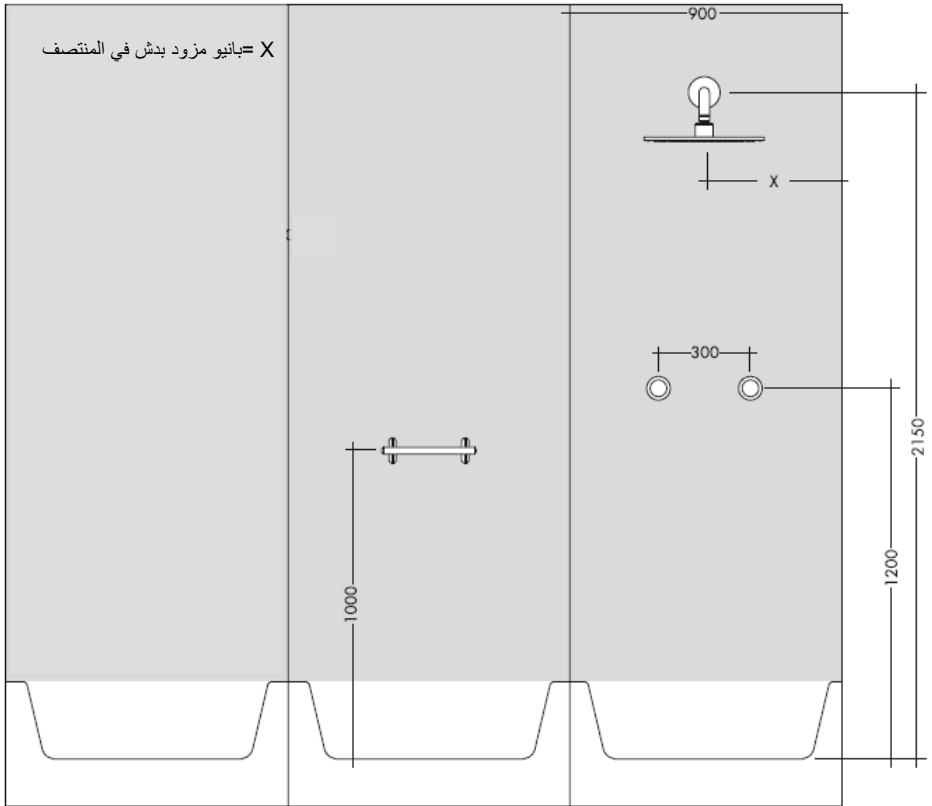
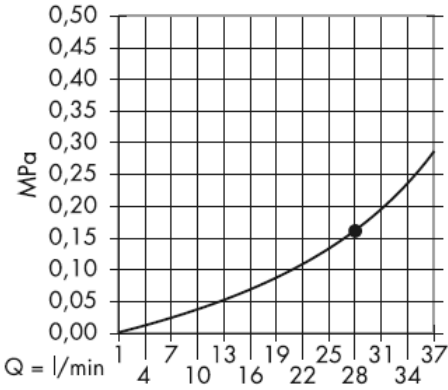

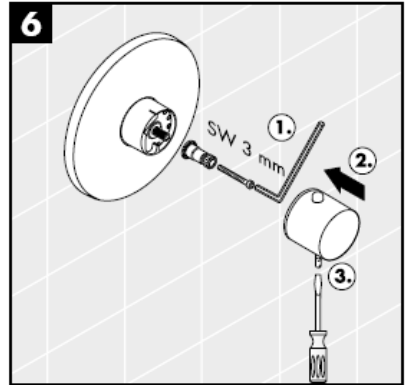
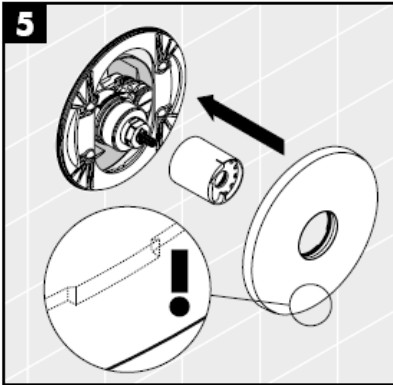
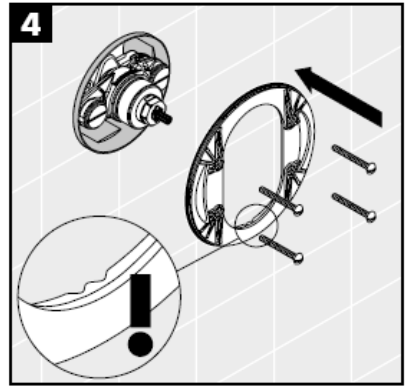
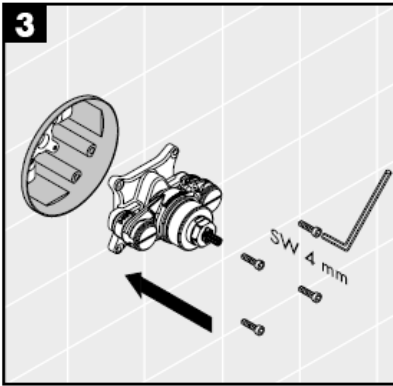
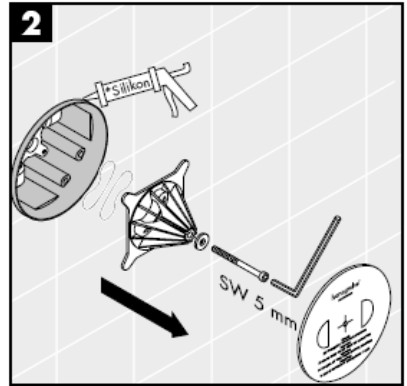
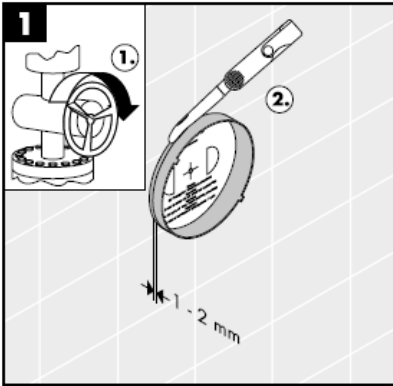

سيلكون (خالي من حمض الخليك!)

يمكن إجراء ضبط مسبق للحد الأقصى لدرجة الحرارة المرغوبة، على سبيل المثال بحد أقصى 42 بفضل وظيفة الأمان.

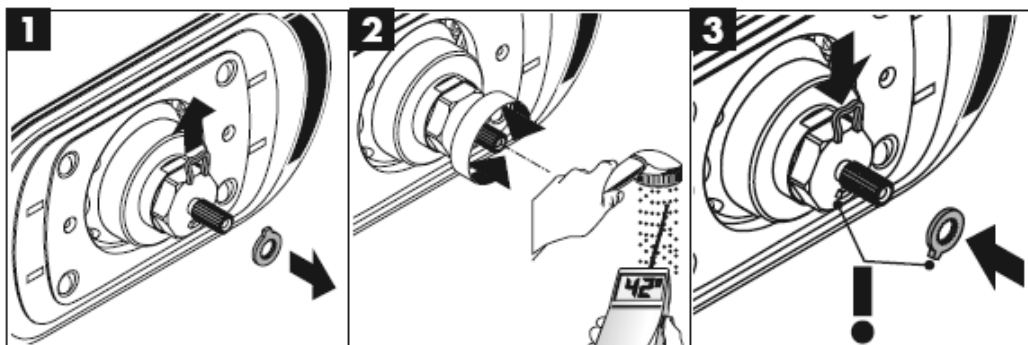

الضبط

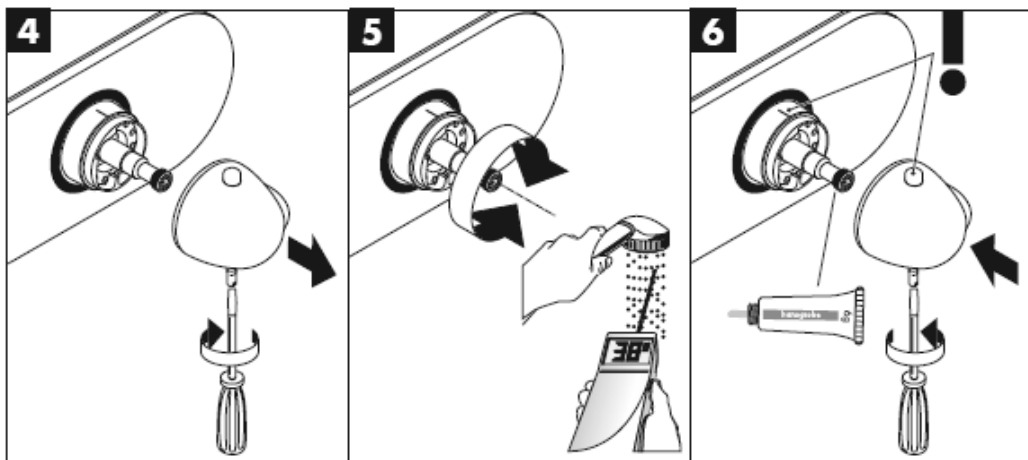



وزن الرشاش في حالة الإستخدام بالإضافة الى ذراع اترشاش يبلغ حوالي 10 كجم. لذلك يجب إستخدام المواد المناسبة في الحائط عند التركيب! المسامير الملولبة والدراسات المرفقة مخصصة فقط للحوائط المصمتة.

لا تستخدم سوى مواد الربط الملائمة للبناء بالطوب! المسامير الملولبة والأوتاد المرفقة مخصصة للمباني الطوبية الصلبة فقط.

يجب أن يكون الأداء من حيث حجز الفضلات ذا حجم مناسب.

الاستخدام الأمثل مضمون فقط مع مجموعة ثرموستات التدفق العالي من هانزجرهه.

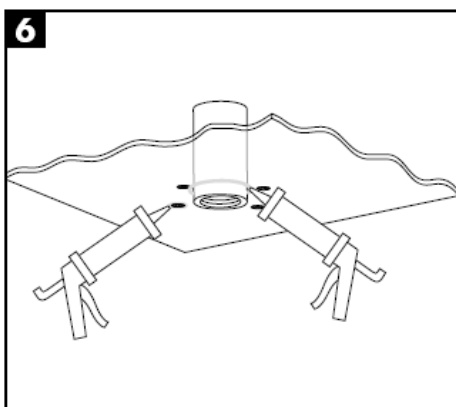
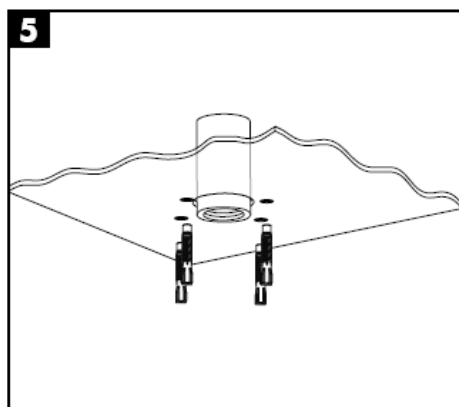
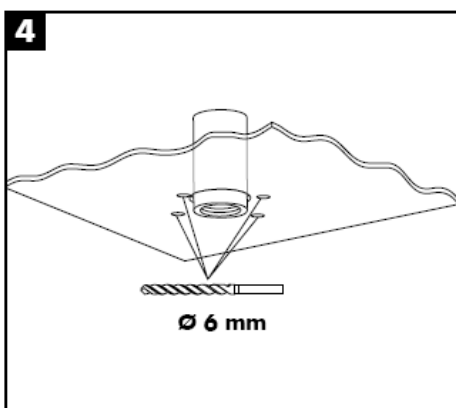
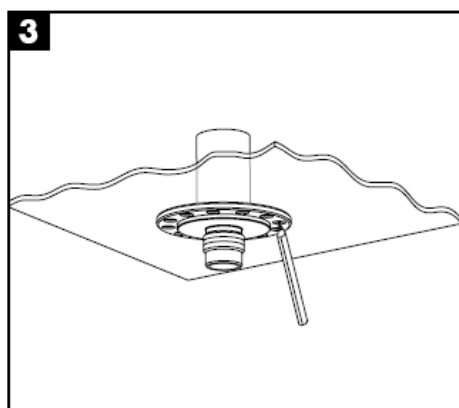
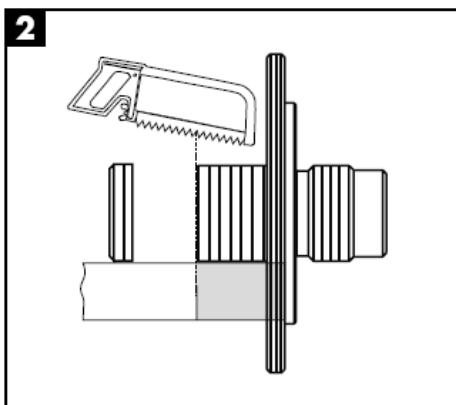
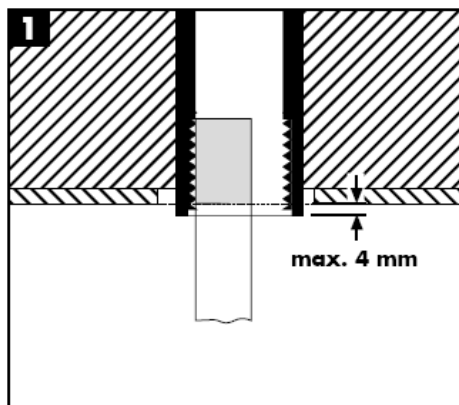

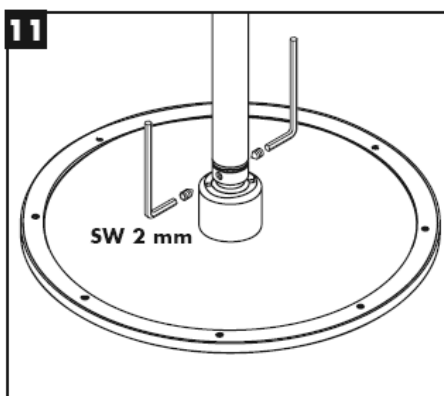
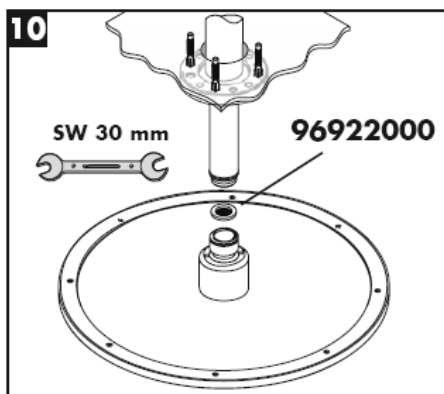
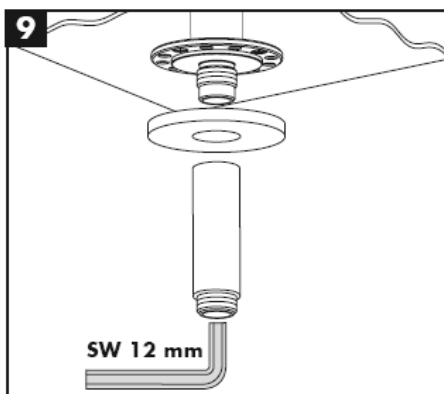
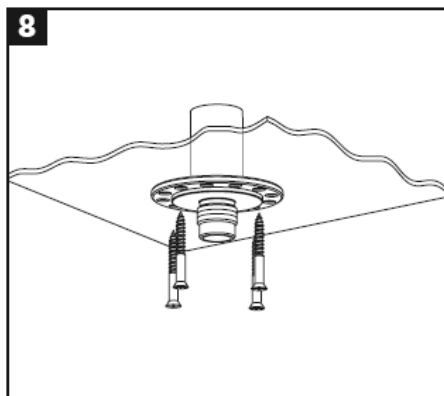
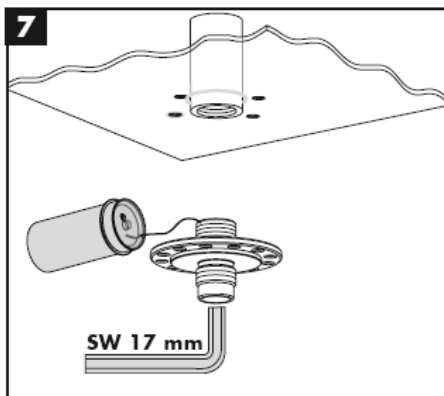

يجب إدخال الحلقة الشبكية لحماية الدش اليدوي من الأوساخ التي تحملها شبكة المواسير. حيث تؤدي الأوساخ الواردة إلى حدوث أعطال أو / وقد تتسبب في تلف أجزاء من من الدش، ومثل هذه الأعطال تلغى كافة المطالبات الخاصة بالمسؤولية أو الضمان.

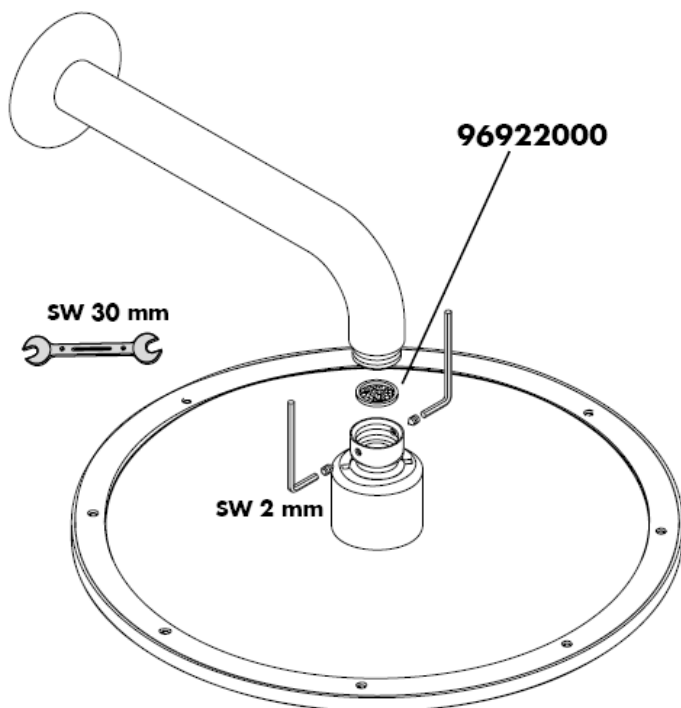

التثبيت

تنبيه! يجب تركيب الوصلة، وغمرها بالماء واختبارها وفقاً للمعايير السارية!

الضبط

يلزم إجراء تصحيح إذا اختلفت درجة الحرارة المقاسة عند نقطة البداية عن درجة الحرارة المحددة على المقياس. لضبط درجة الحرارة عليك القيام بما يلي:

تدوير مقبض الضبط إلى أن تصل درجة حرارة الماء الخارج من المخرج إلى 38 مئوية. إرخاء المسامير الملولب الموجود بمقبض الضبط. فك مقبض الضبط والتدوير إلى وضع 38 مئوية. إعادة توصيل مقبض الضبط وإحكام ربط المسامير الملولب (يرجى الرجوع إلى صفحة 22).

تجهيزة تحديد درجة الحرارة

ويتم الحد من درجة الحرارة من خلال ضبط الأمان عند 38 C م (100 F ف). عند الحاجة إلى درجة حرارة أعلى من ذلك، يمكن تخفي إيقاف الأمان من خلال الضغط على زر الأمان.

وظيفة الأمان

يمكن إجراء ضبط مسبق للحد الأقصى لدرجة الحرارة المرغوبة، على سبيل المثال بحد أقصى 42 بفضل وظيفة الأمان. راجع صفحة 21.

المواصفات الفنية

ضغط التشغيل: max. 1 MPa
 ضغط التشغيل الموصى به: 0,1 – 0,5 MPa
 ضغط الاختبار: 1,6 MPa
 (1 MPa = 147 PSI بار 10)
 درجة حرارة الماء الساخن: max.80° C
 درجة الحرارة الموصى بها للماء الساخن: 65° C
 معدل التدفق: ca.58 l/min 0,3 MPa

الصيانة

لا توجد صيانة خاصة للثرموستات. يجب فحص صمام عدم الرجوع بصفة منتظمة حسب المواصفة DIN EN 1717 وذلك طبقاً للوائح الوطنية أو الإقليمية (مرة واحد سنوياً طبقاً للمواصفة DIN 1988). في الوقت الحالي، الرجاء أيضاً فحص المرشح الموجود فوق المقياس الحراري (6.1 MTC). بعد تركيب منظم الحرارة (6 MTC)، من الضروري فحص حرارة المياه عند نقطة الخروج الموضحة ضمن المعلومات الموجودة أسفل العنوان "الضبط". قبل إجراء الضبط، الرجاء التحقق من استخدام مصدر المياه الساخنة وبلوغ الماء درجة الحرارة القصوة عند نقطة الخروج.

لضمان التشغيل السلس للثرموستات، من الضروري تحويله من وقت إلى آخر من أقصى سخونة إلى أقصى البرودة.

قطع الغيار راجع صفحة3

38391000	1	مقبض الثرموستات
96452000	2	طرف
97439000	3	جلبية وصل
96454000	4	مسمار التثبيت
96447000	5	لوحة الحامل
96633000	6	منظم حرارة
97367000	7	مرشح الاستساخات
96655000	8	صمام عدم الرجوع
13595000	9	وصلة إطالة 25 مم
13596000	10	وصلة إطالة 25 مم

العطل	السبب	العلاج والإصلاح
الماء قليل	-ضغط الإمداد ليس كافيًا -مرشح الاتساخات الخاص بالمنظم متسخ -سدادة مصفاة الدش متسخة	-افحص ضغط المواسير -قم بتنظيف مرشح الاتساخات -نظف سدادة المصفاة بين الدش والخرطوم
تدفق منعكس للمياه! الماء الساخن يندفع في ماسورة البارد أو العكس والخلاط مغلق. حرارة المياه لا تتوافق مع درجة الحرارة المضبوطة	-صمام منع الرجوع متسخ / تالف -لم يتم ضبط الترموستات	-قم بتغيير صمام منع الرجوع -اضبط الترموستات
تنظيم الحرارة غير ممكن	-درجة حرارة الماء الساخن منخفضة للغاية -منظم الحرارة متسخ أو عليه جير	-ارفع حد الماء الساخن إلى 42 – 65 درجة مئوية -تم تركيب الجزء الرئيسي من الخلاط بشكل خاطيء (ينبغي أن يكون البارد يمينًا، والساخن يسارًا) أو تم عكسه 180 درجة -زر الضغط الخاص بقتل الأمان لا يعمل
الياء تالف	-قم بتركيب الكنتلة بالعكس 180 درجة -قم بتنظيف الياء أو زر الضغط مع تشحيمهما بشكل خفيف، أو قم بتغييرهما إذا لزم الأمر -هناك جير على زر الضغط	-قم بتنظيف الياء أو زر الضغط مع تشحيمهما بشكل خفيف، أو قم بتغييرهما إذا لزم الأمر -قم بتنظيف الياء أو زر الضغط مع تشحيمهما بشكل خفيف، أو قم بتغييرهما إذا لزم الأمر

شهادة اختبار

	P-IX	DVGW	SVGW	WRSA	KIWA	ACS	NF
27070000						X	
27418XXX							
28420000						X	
28435XXX						X	

التنظيف

إنه سهل التنظيف، حيث يسقط الجير بسهولة شديدة من الأجزاء الناتئة.

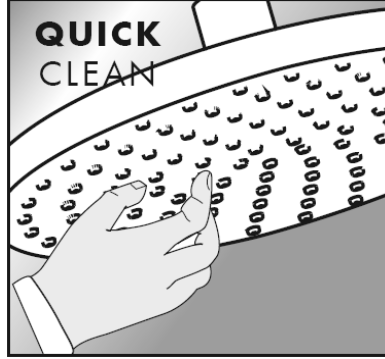

تعليمات التنظيف

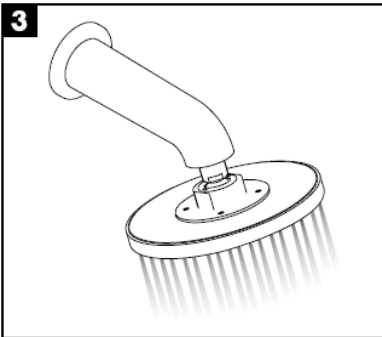
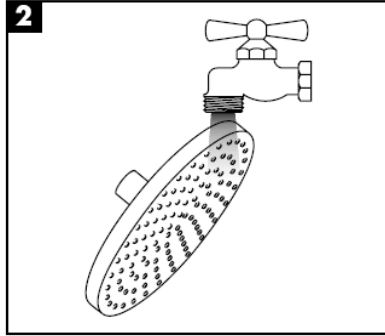
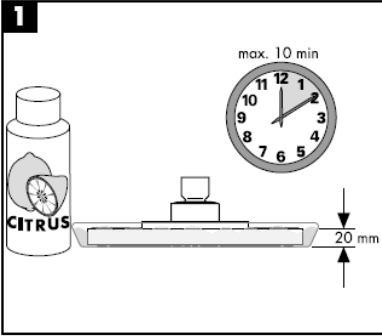

hansgrohe

Hansgrohe · Postfach 1145 · D-77761 Schiltach · Telefon +49 (0) 78 36/51-1282 · Telefax +49 (0) 7836/511440
E-Mail: info@hansgrohe.com · Internet: www.hansgrohe.com

01/2009
9.05170.04
عربي

Navodila za montažo



27418XXX

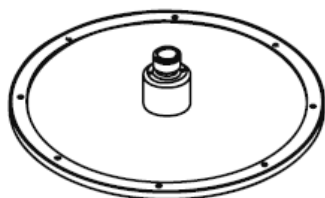

Raindance Royale AIR
28420000

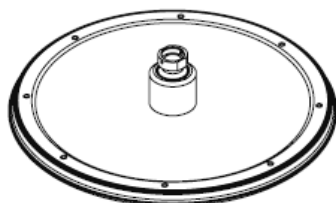

Raindance Royale Classic AIR
28435XXX

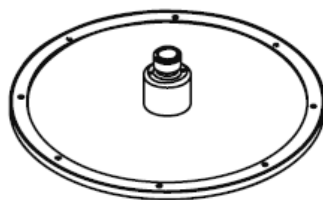

**Raindance Royale
High Flow Set**
27070000

hansgrohe

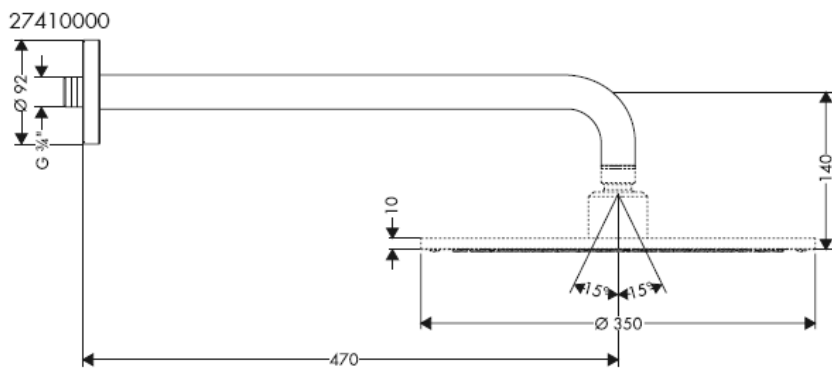
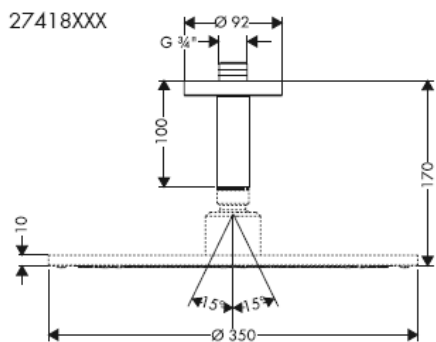
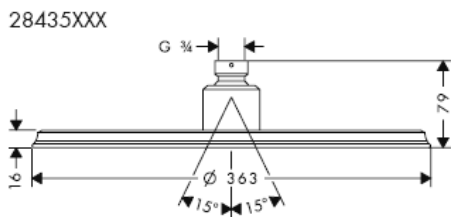
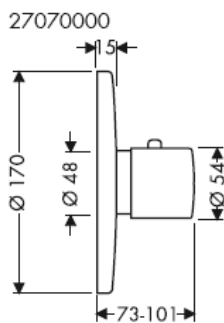
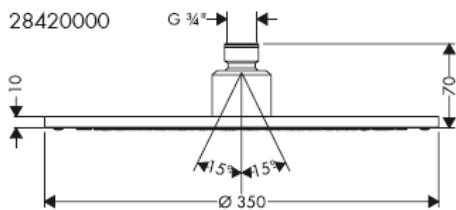

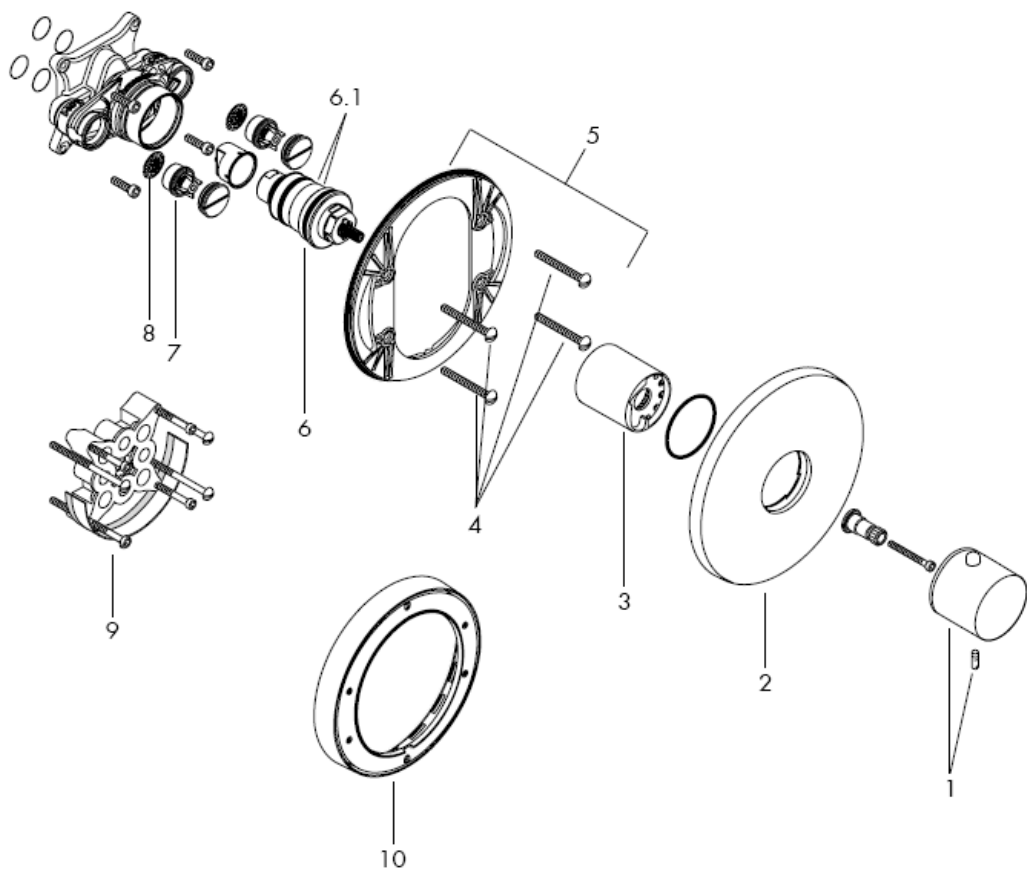

Mere kar najbolj prilagodite vzorcu ploščic.

Potrebno je ojačanje stene za pritržitev ročke za prho

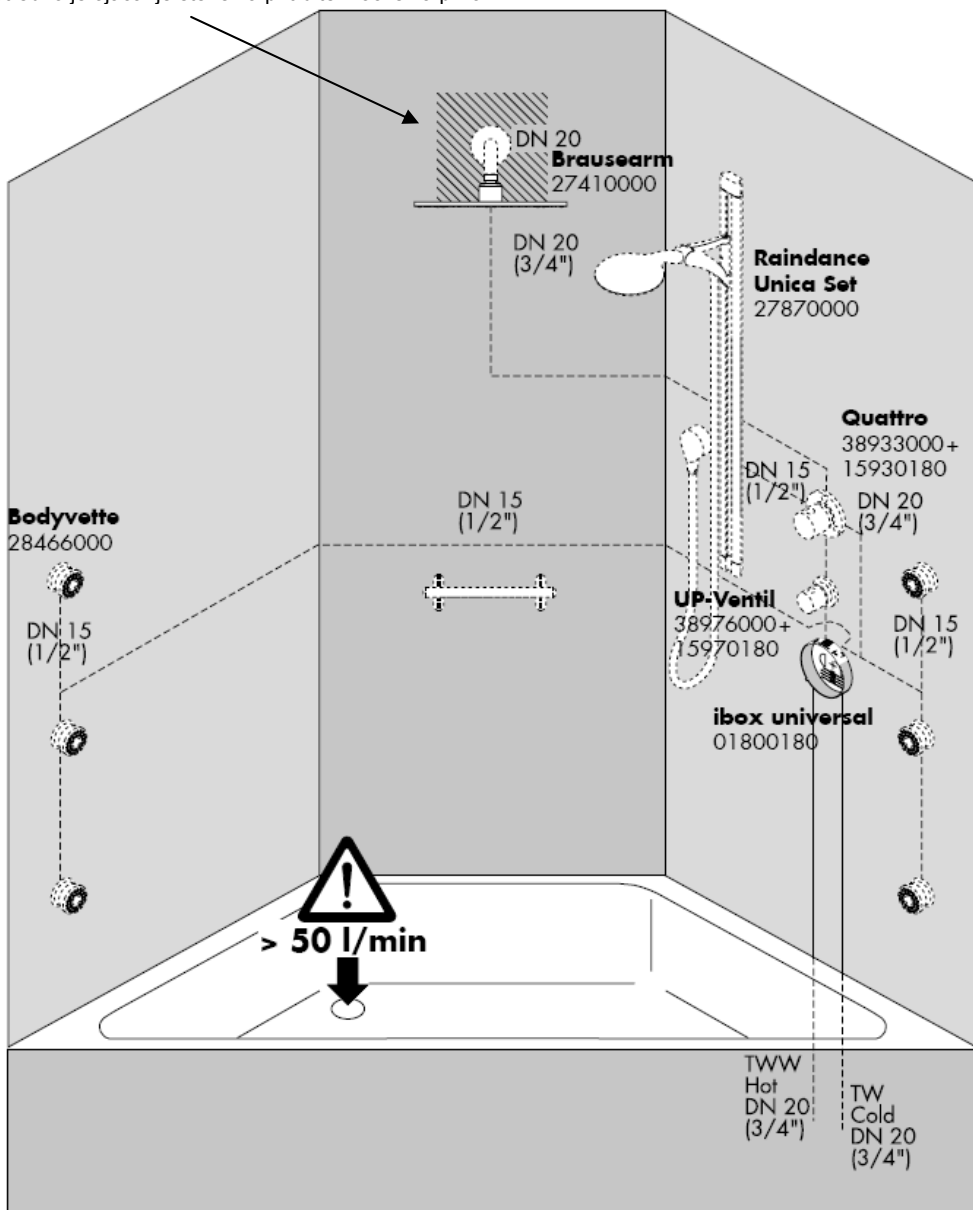

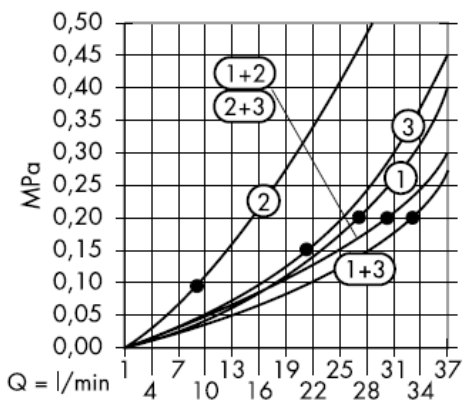

Od • je delovanje zagotovljeno.

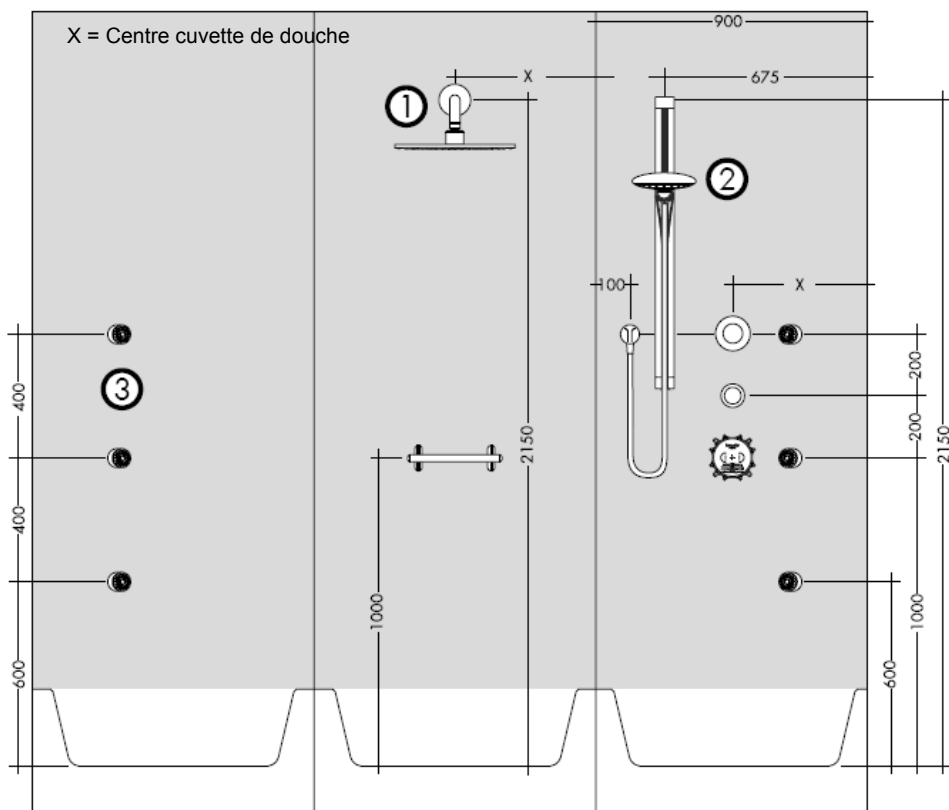

Potrebno je ojačanje stene za pritrnitev ročke za prho

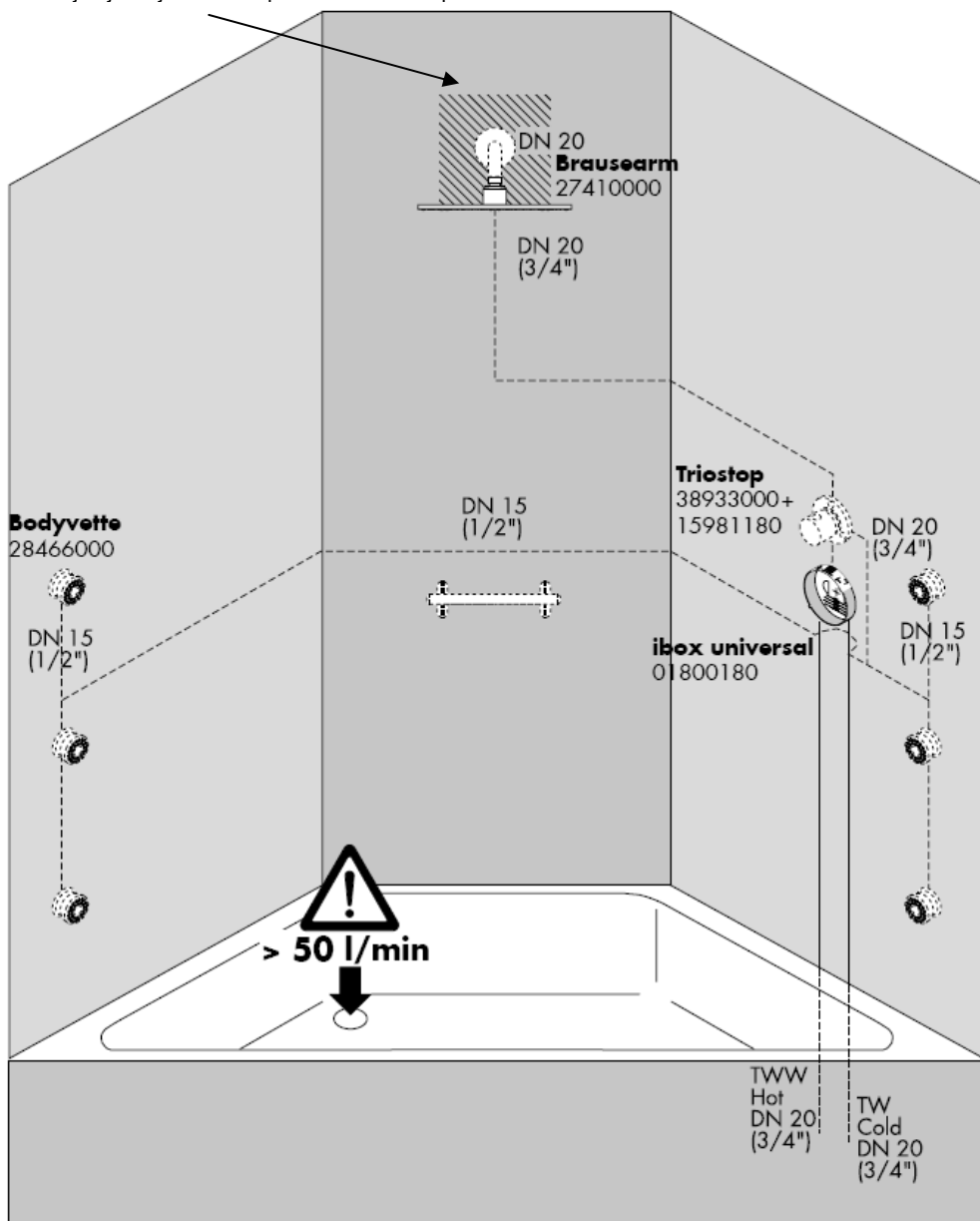

Potrebno je ojačanje stene za pritrnitev ročke za prho

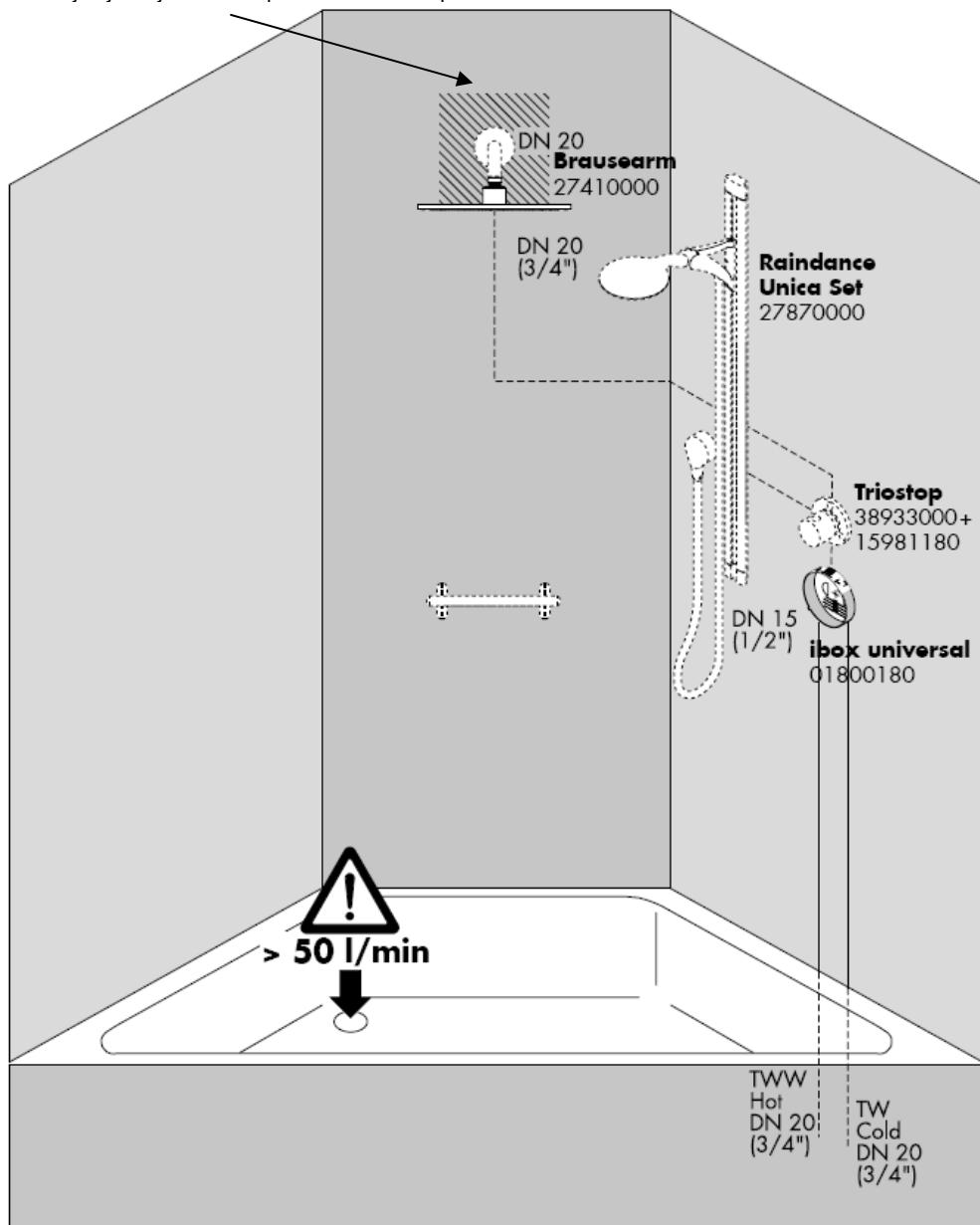

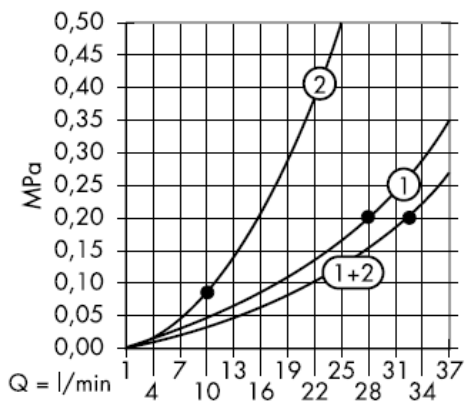

Od • je delovanje zagotovljeno.

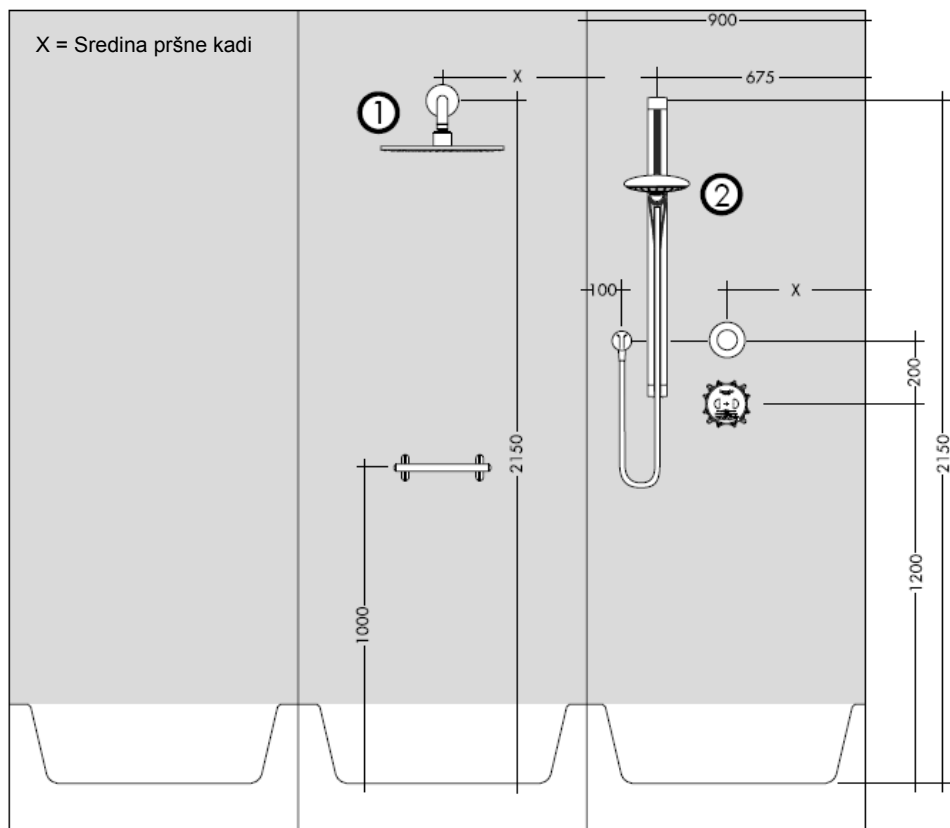

Potrebno je ojačanje stene za pritrnitev ročke za prho

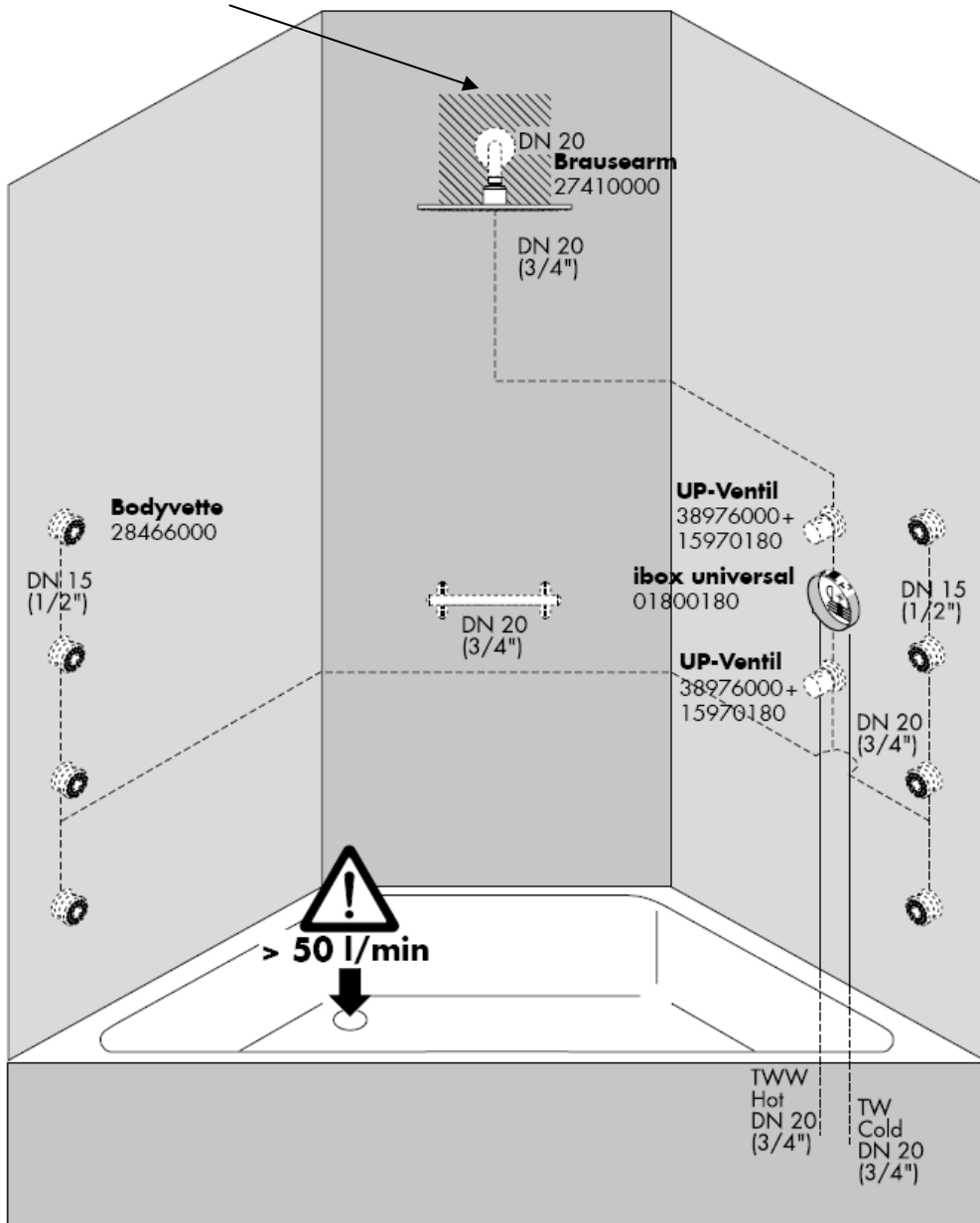

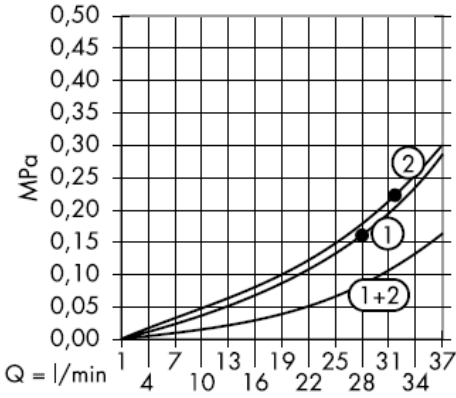

Od • je delovanje zagotovljeno.

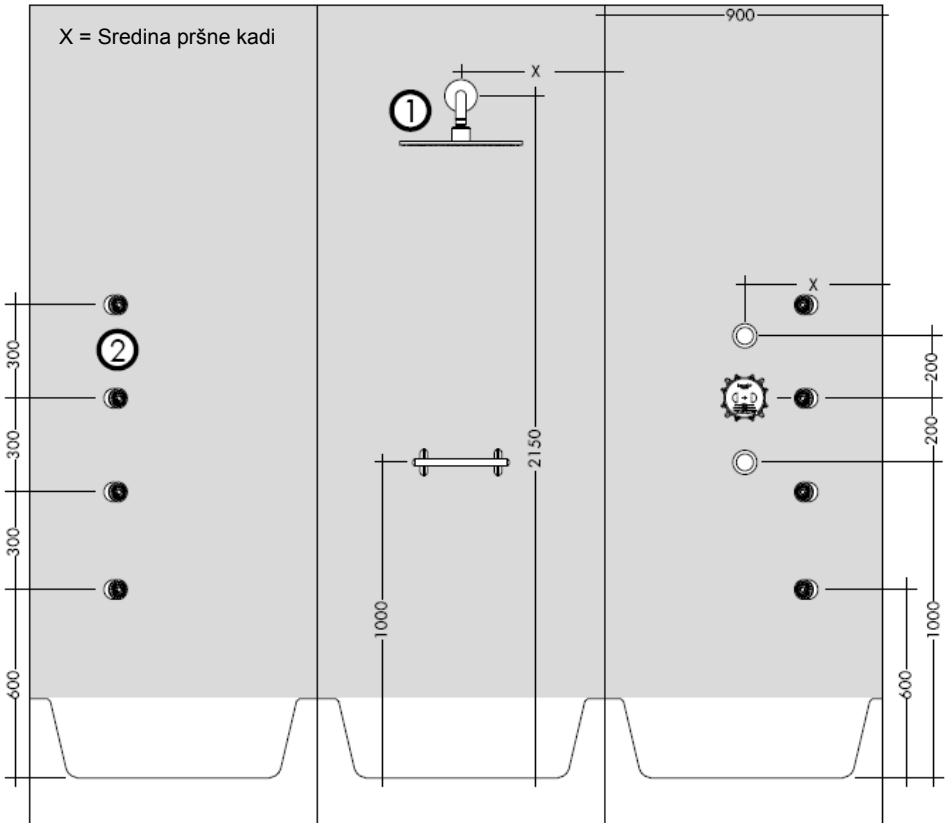

Potrebno je ojačanje stene za pritrnitev ročke za prho

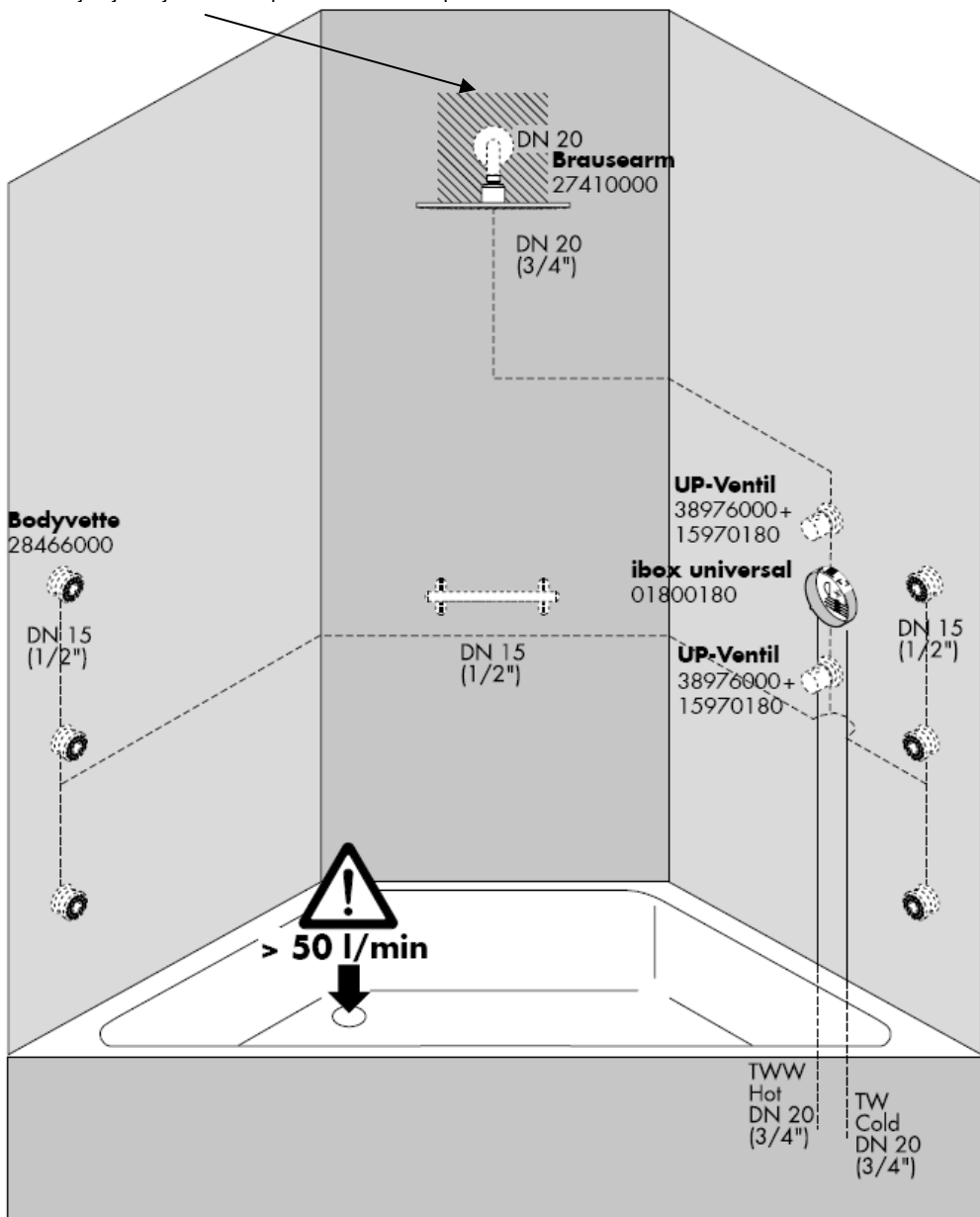

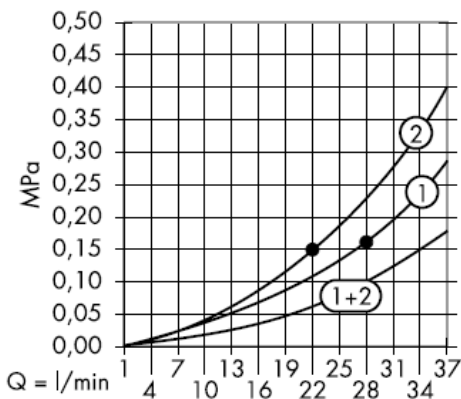

Od • je delovanje zagotovljeno.

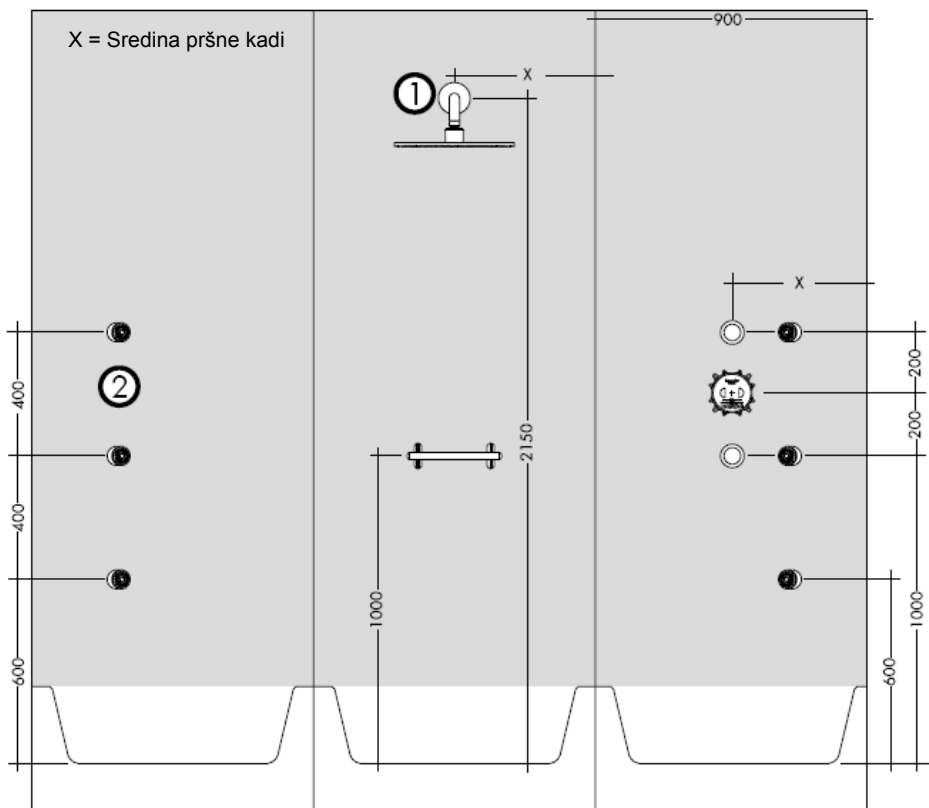

Potrebno je ojačanje stene za pritržitev ročke za prho

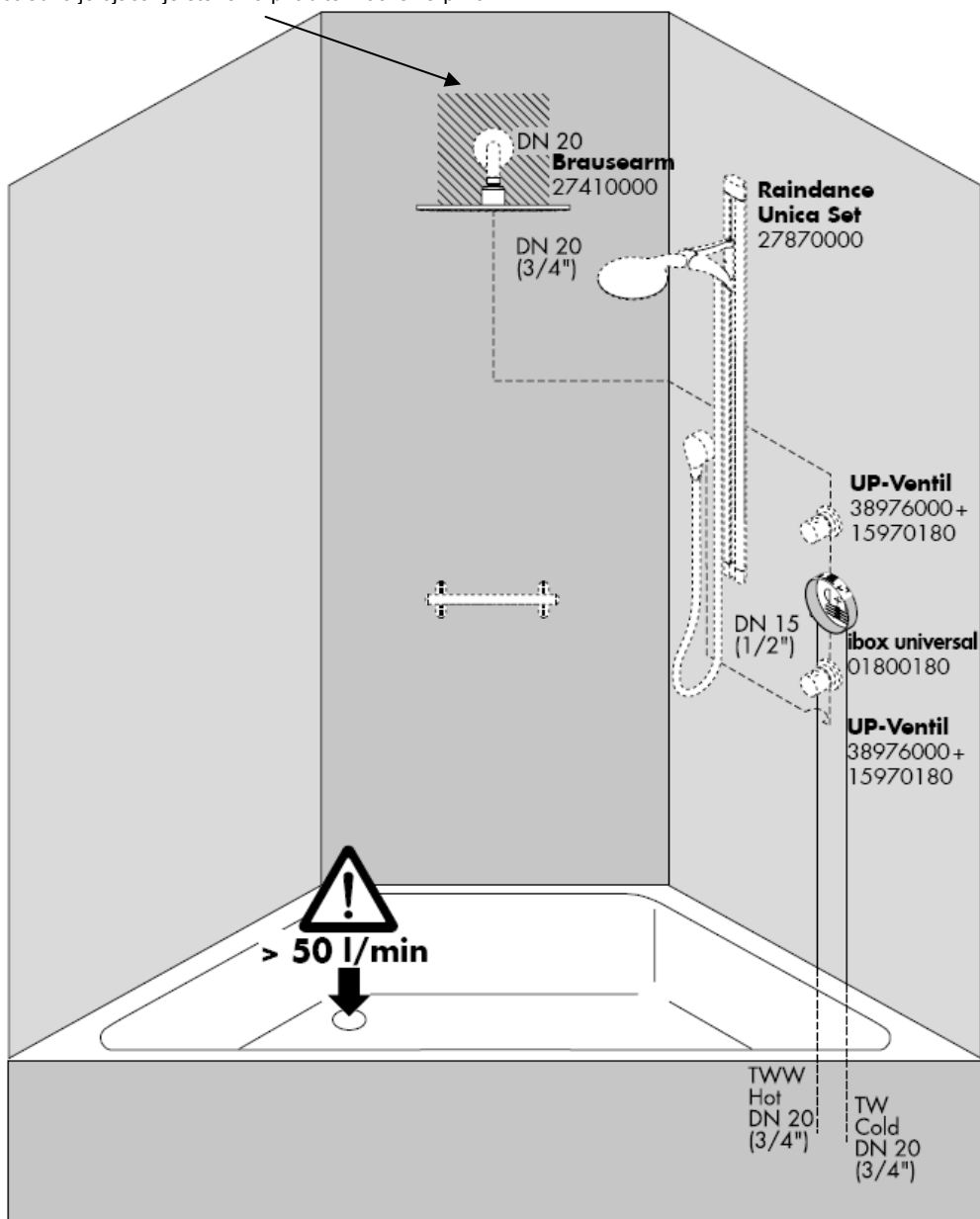

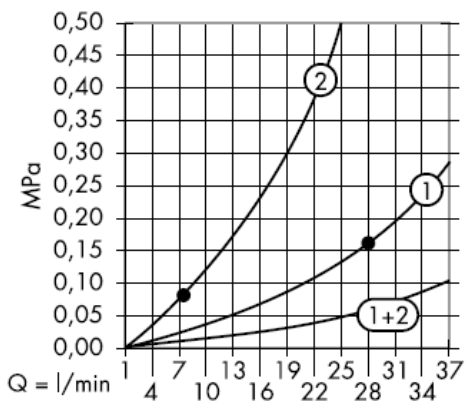

Od • je delovanje zagotovljeno.

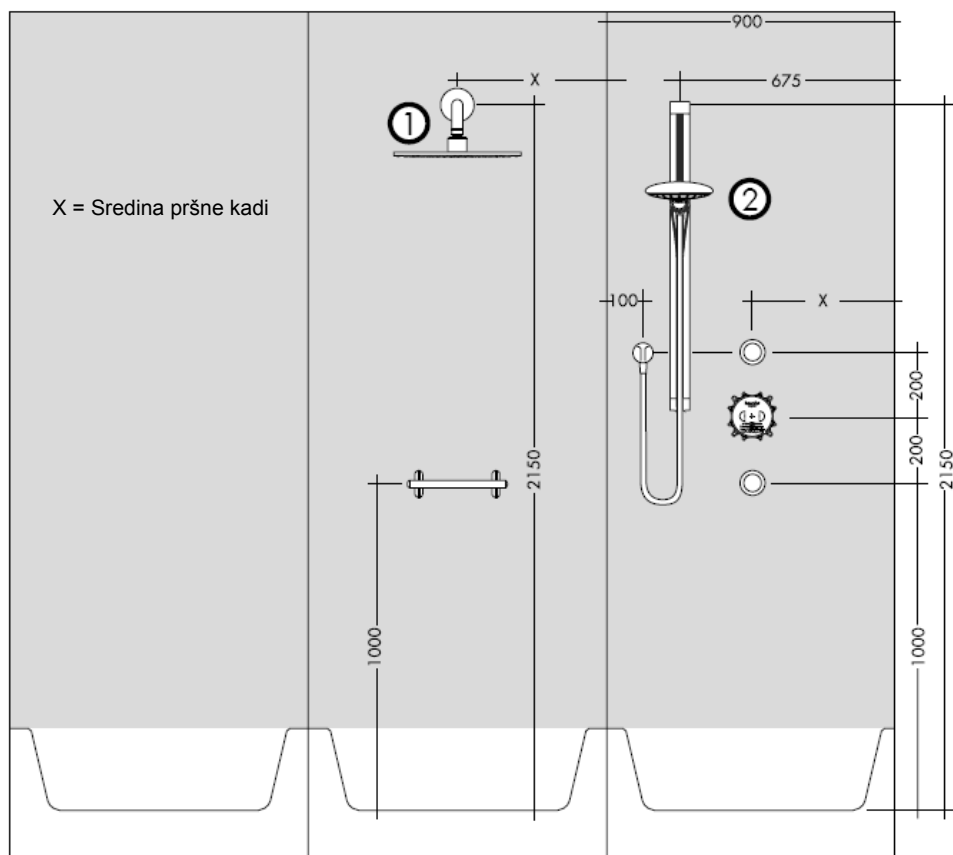

Potrebno je ojačanje stene za pritrnitev ročke za prho

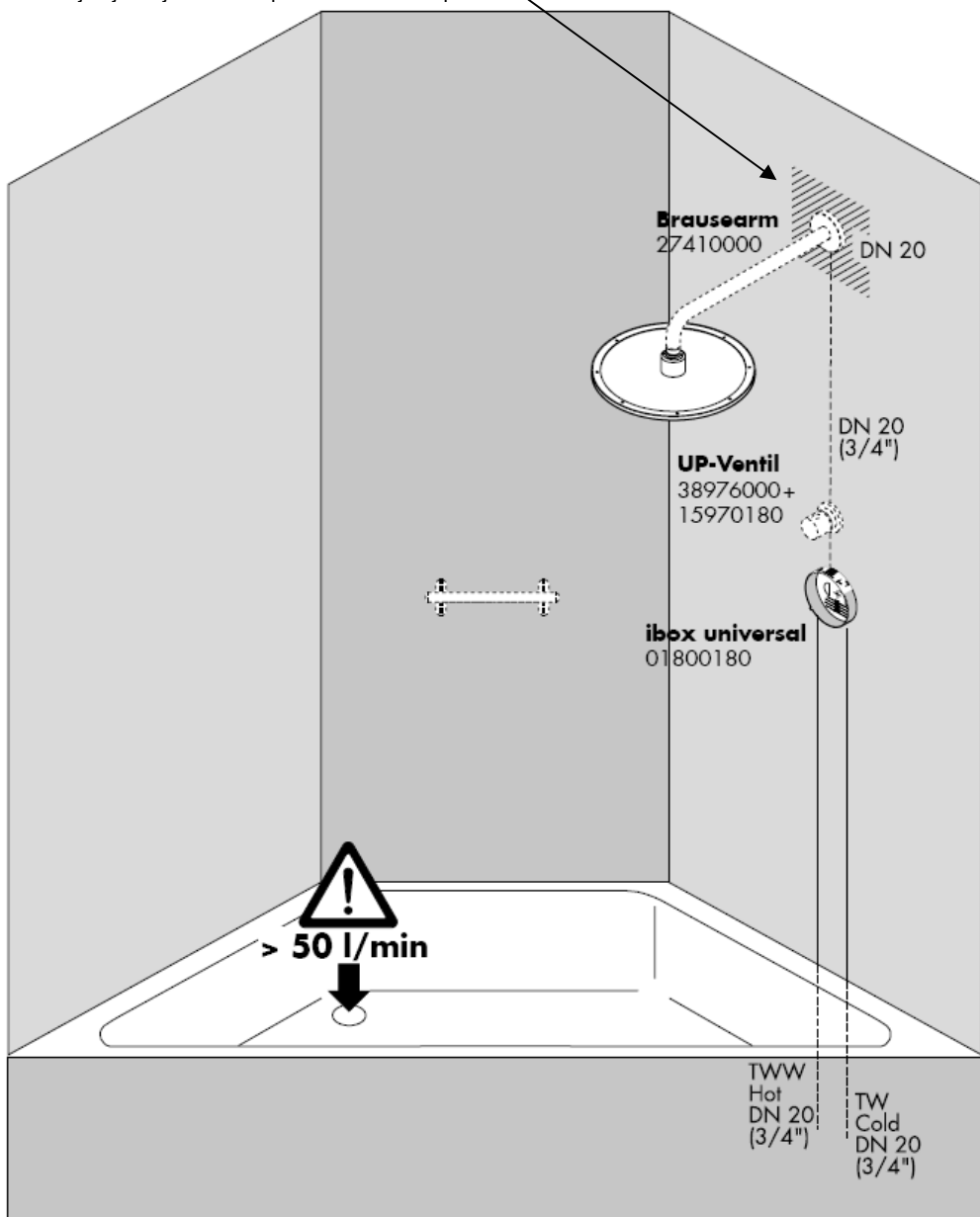

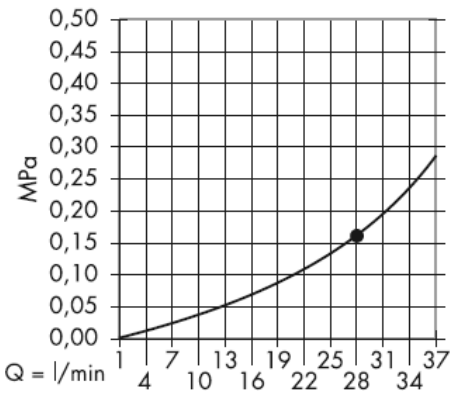

Od • je delovanje zagotovljeno.

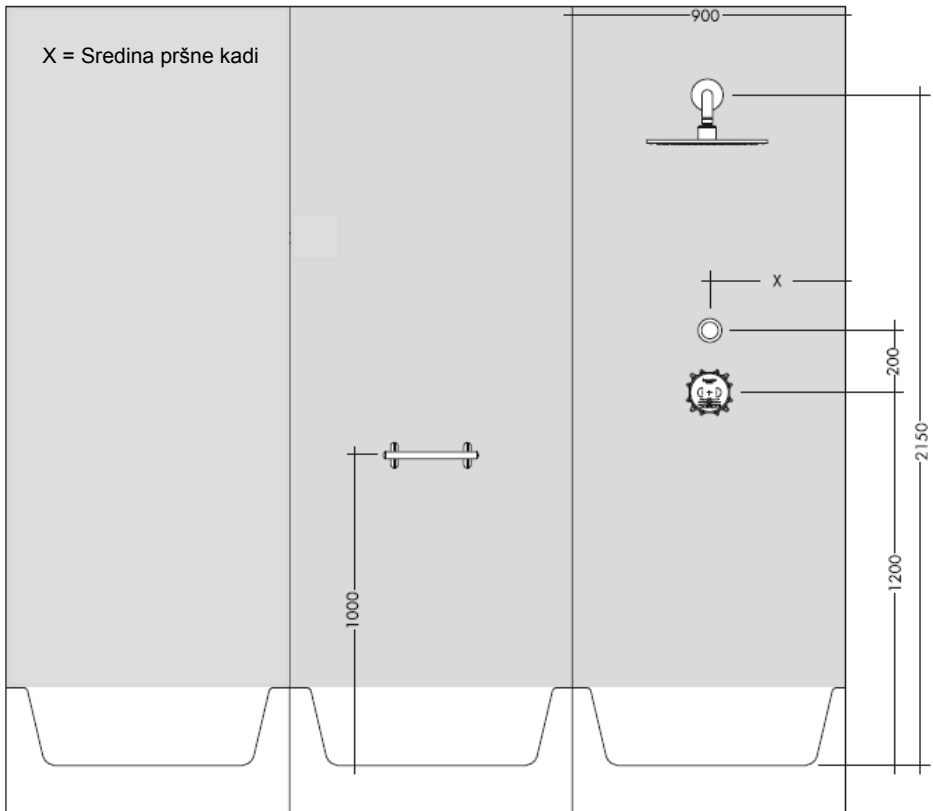

Potrebno je ojačanje stene za pritrnitev ročke za prho

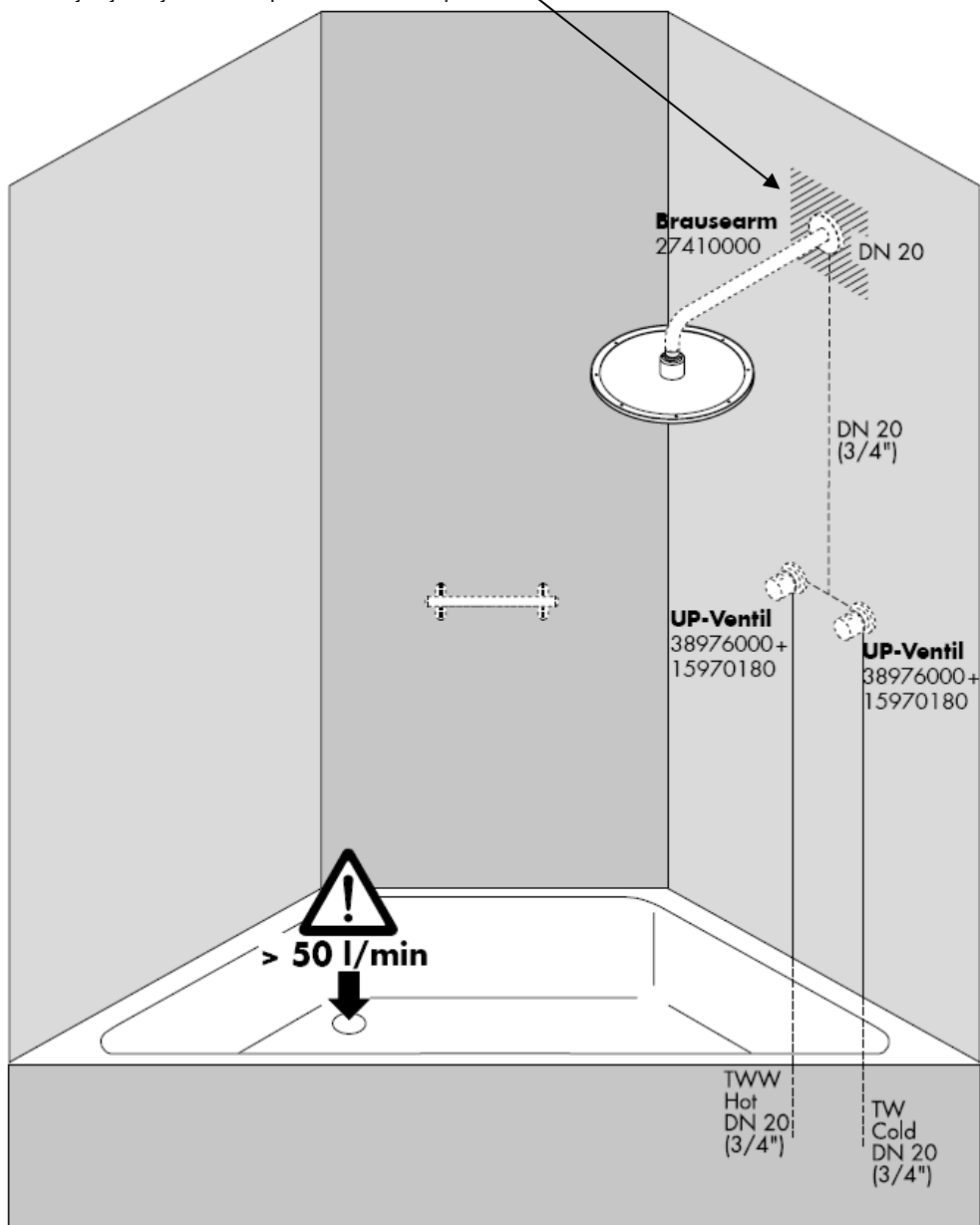

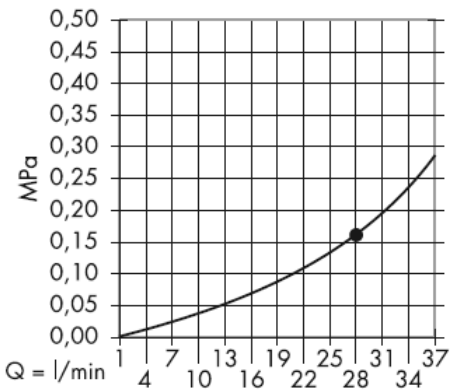

Od • je delovanje zagotovljeno.

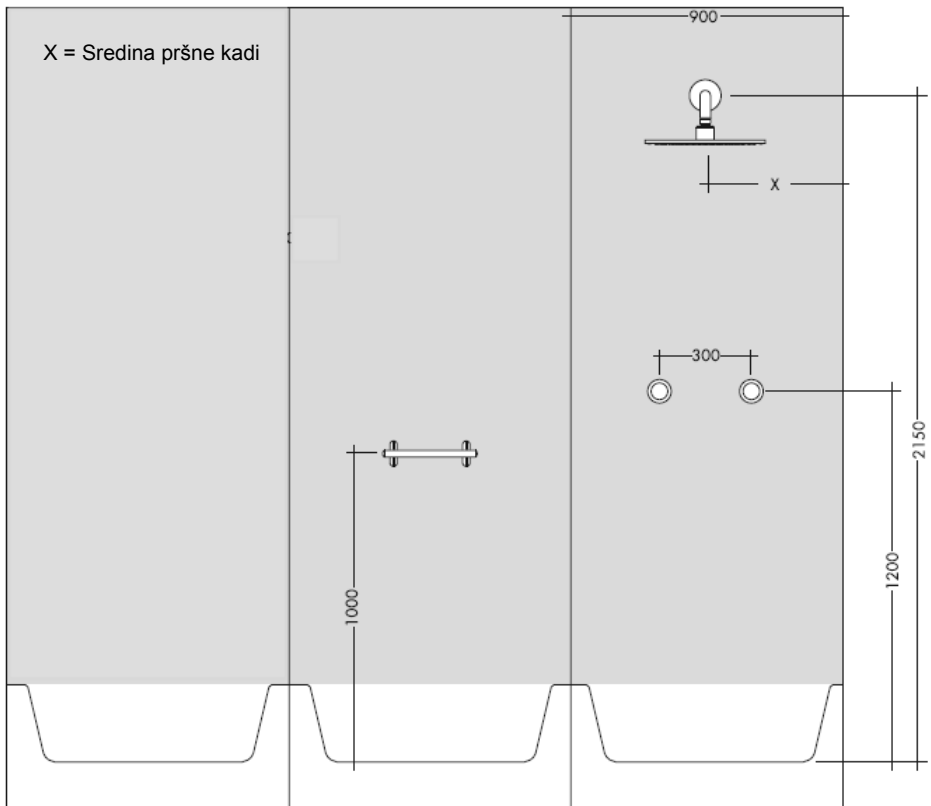

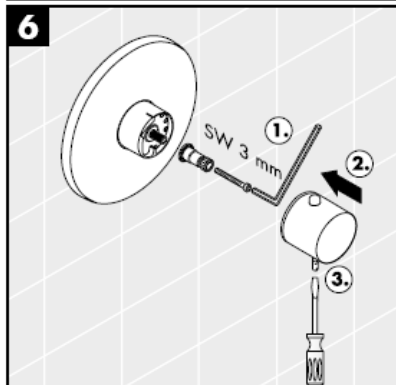
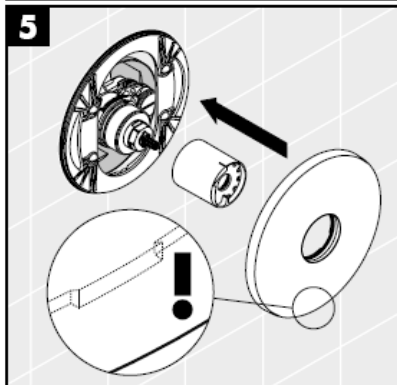
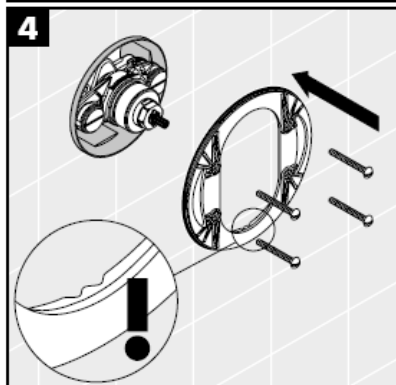
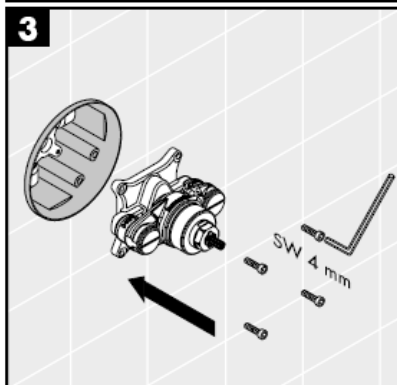
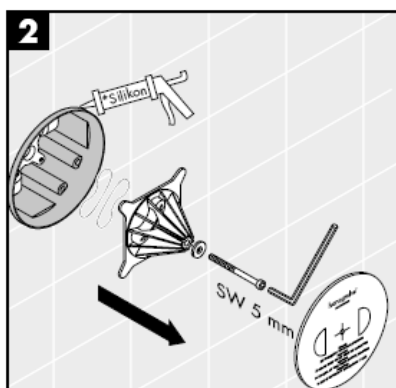
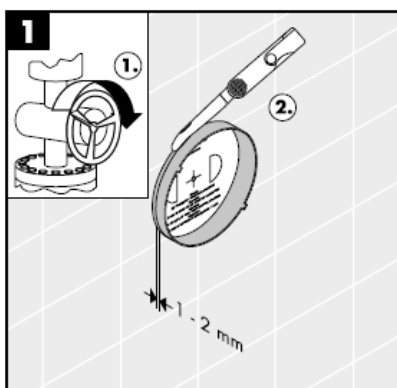

Silikon (brez očetne kisline)

Varnostna funkcija omogoča, da vnaprej nastavimo najvišjo želeno temperaturo npr. 42 C.

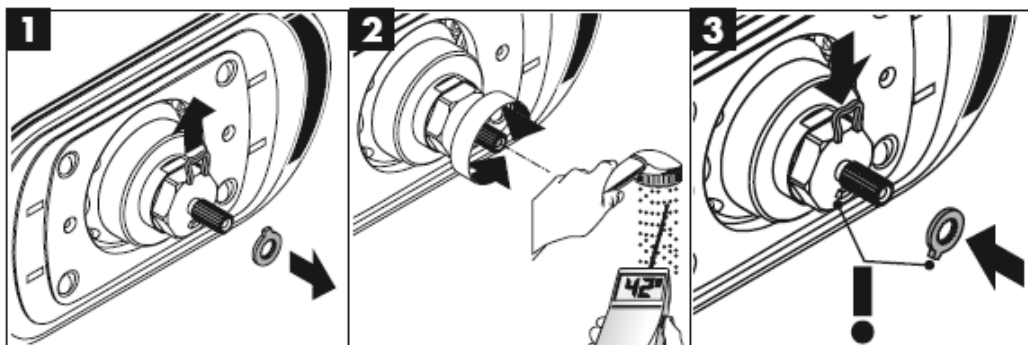

Nastavitev

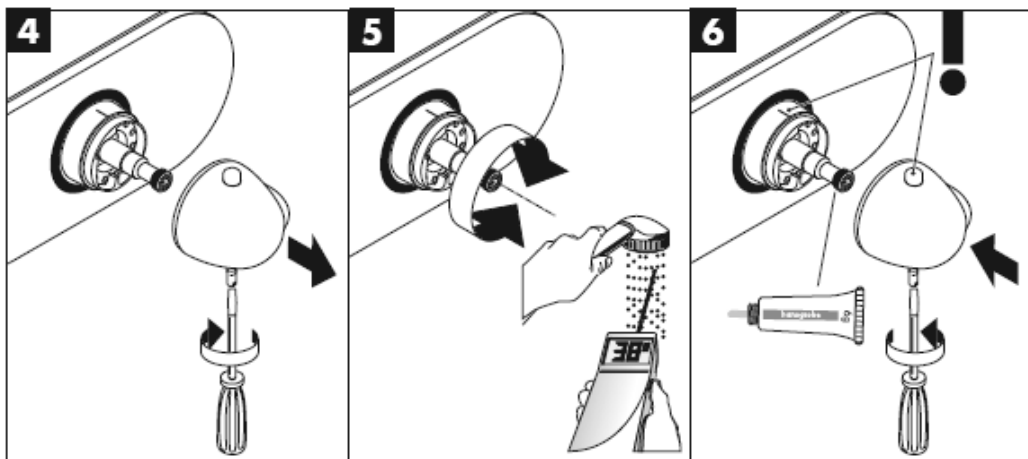



Ko je prha v uporabi, tehta skupaj z nosilcem ca. 10 kg. Zato je dovoljena le uporaba pritrditvenega materiala, ki je primeren za obstoječe zidovje! Priloženi vijaki in mozniki so primerni le za masivne zidove.

Uporabite lahko le pritrdilni material, primeren za opečnat zid! Priloženi vijaki in vložki so primerni samo za masiven zid.

Zmogljivost odtoka mora biti ustrezne velikosti.

Optimalno delovanje je zagotovljeno le v povezavi s High Flow termostati Hansgrohe.

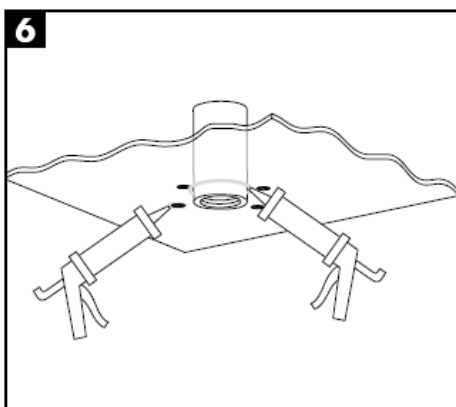
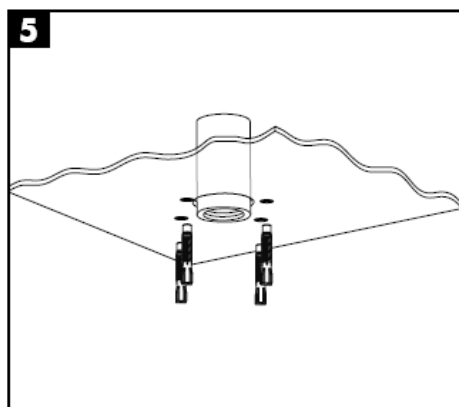
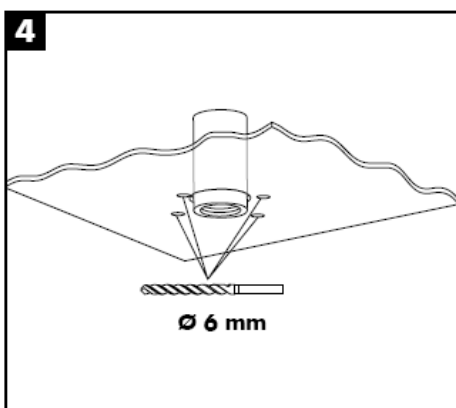
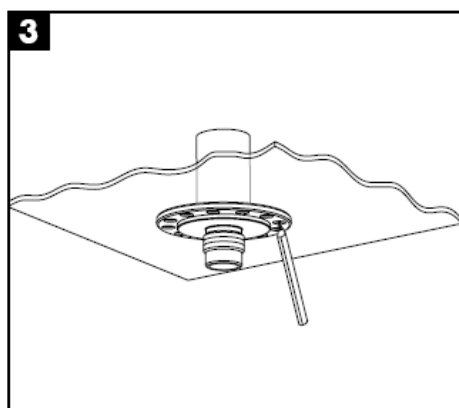
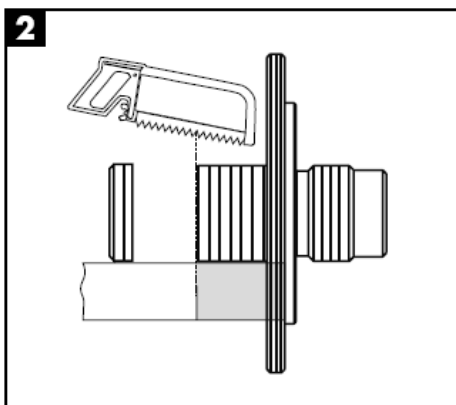
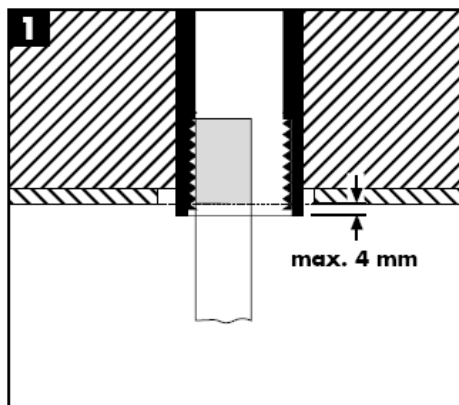

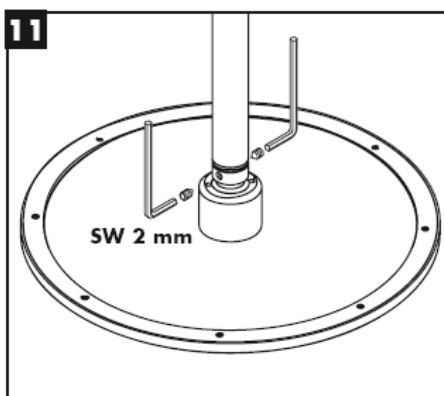
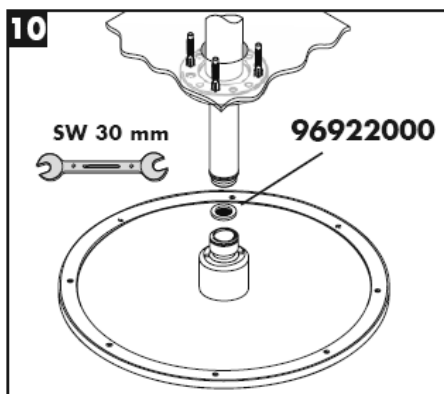
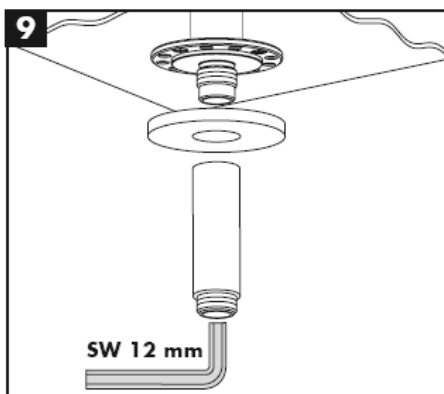
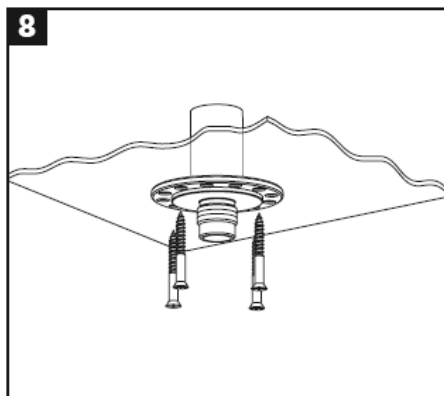
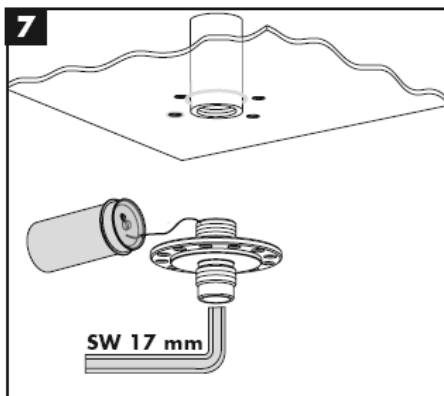

Filter, ki je priložen ročni prhi, je potrebno vgraditi, da prho zaščitimo pred umazanijo iz vodovodne napeljave. Umazanija lahko okvari ali poškoduje dele ročne prhe. Za tako nastalo škodo Hansgrohe ne odgovarja.

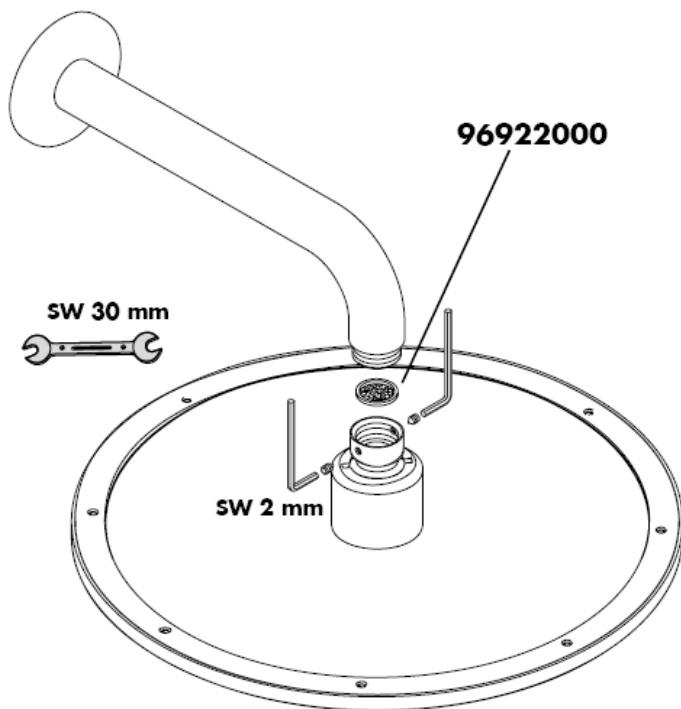

Montaža

Pozor! Armaturo je potrebno montirati, sprati in testirati v skladu z veljavnimi normami!

Nastavitev

Popravek je potreben, če se izmerjena temperatura pri izlivu razlikuje od na termostatu nastavljene temperature. Pri tem je treba upoštevati: Nastavitveno ročico obračajte, dokler temperatura vode na izlivu ni 38° C. Odvijte vijak na ročici, ročico odstranite in zavrtite do položaja 38° C. Ročico nataknite nazaj in zatisnite vijak (Glejte stran 22).

Omejitev temperature

Temperaturno območje je z varnostno zaporo omejeno na 38 °C (zaščita pred poparjenjem). Če želite višjo temperaturo, lahko zaporo prekoračite s pritiskom na varnostni gumb.

Varnostna funkcija .

Varnostna funkcija omogoča, da vnaprej nastavimo najvišjo želeno temperaturo npr. 42 °C. glejte stran 21.

Tehnični podatki

Delovni tlak: max. 1 MPa
Priporočeni delovni tlak: 0,1 – 0,5 MPa
Preskusni tlak: 1,6 MPa
(1 MPa = 10 bar = 147 PSI)
Temperatura tople vode: max. 80° C
Priporočena temperatura tople vode: 65° C
Pretok vode: ca. 58 l/min 0,3 MPa

Vzdrževanje

Termostati ne potrebujejo posebnega vzdrževanja. Delovanje protipovratnega ventila je potrebno v skladu z DIN EN 1717 in skladno z državnimi in regionalnimi določili (DIN 1988 enkrat letno) redno testirati. Ob tej priložnosti preverite tudi filtre, ki se nahajajo na enoti za uravnavanje MTC (6.1). Po montaži MTC-enote (6) nujno preverite temperaturo izliva, kot je to opisano pod točko "Justiranje". Pred tem nujno preverite, da je oskrba s toplo vodo vključena in da je maksimalna temperatura tople vode na mestu odvzema na voljo.

Da bi zagotovili gladko delovanje enote za uravnavanje, je potrebno termostat občasno nastaviti popolnoma na toplo in popolnoma na mrzlo.

Rezervni deli glejte stran 3

1	Termostatska ročka	38391000
2	Rozeta	96452000
3	Obojka	97439000
4	Nosilni vijaki	96454000
5	Nosilna rozeta	96447000
6	Enota za uravnavanje temperature	96633000
7	Filtrirna mrežica	97367000
8	Protipovratni ventil	96655000
9	Podaljšek 25 mm	13595000
10	Podaljšek 25 mm	13596000

Slovenski

Napaka	Vzrok	Pomoč
Malo vode	-Nezadosten oskrbovalni tlak -Filter enote za uravnavanje je umazan -Filtrirna mrežica prhe je umazana	-Preverite tlak v ceveh -Očistite filtre -Očistite filtrirno mrežico med prho in gibko cevjo
Križni tok, toplo vodo ob zaprti armaturi potiska v cevi mrzle vode ali obratno	-Protipovratni ventil je umazan/pokvarjen	-Zamenjajte protipovratni ventil
Temperatura vode pri izlivu ne ustreza temperaturi, ki ste jo nastavili.	-Termostat ni bil justiran -Prenizka temperatura tople vode	-Justirajte termostat -Povišajte temperaturo tople vode na 42 °C do 65 °C
Uravnavanje temperature ni mogoče	-Enota za uravnavanje temperature je umazana ali poapnena -Vgradite funkcijski blok za 180 obrnjeno	-Pri novi inštalaciji je osnovni del napačno priključen (moralo bi biti: mrzlo desno, toplo levo) ali vgrajen z zasukom za 180°. -Gumb varnostne zapore ne deluje
Pokvarjena vzmet	-Očistite in rahlo namastite oz. po potrebi zamenjajte vzmet oz. gumb -Gumb je poapnen	-Očistite in rahlo namastite oz. po potrebi zamenjajte vzmet oz. gumb -Očistite in rahlo namastite oz. po potrebi zamenjajte vzmet oz. gumb

Preskusni znak

	P-IX	DVGW	SVGW	WRSA	KIWA	ACS	NF
27070000						X	
27418XXX							
28420000						X	
28435XXX						X	

Čiščenje

Preprosto čisto: apnenec se z lahkoto podrgne z vozličkov.

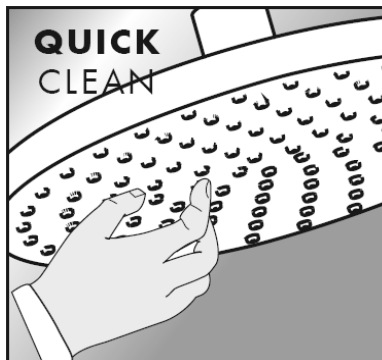

Navodila za nego

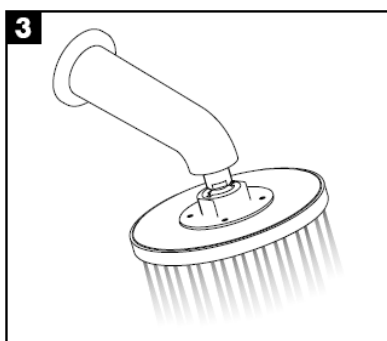
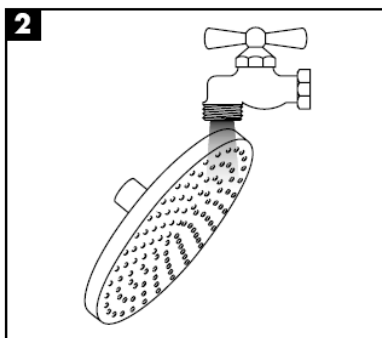
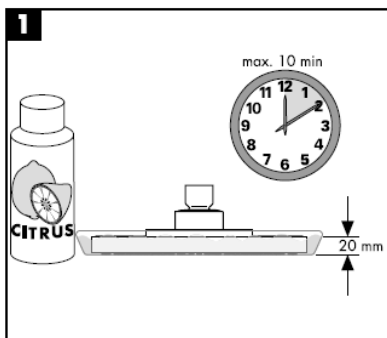

hansgrohe

Paigaldusjuhend



27418XXX

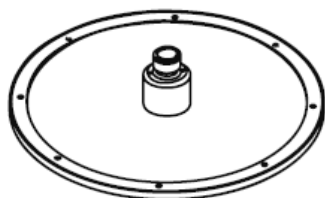

Raindance Royale AIR
28420000

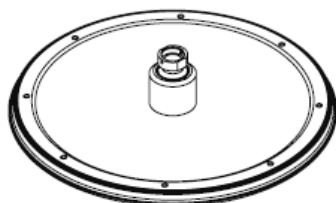

Raindance Royale Classic AIR
28435XXX

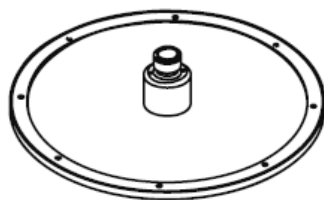

**Raindance Royale
High Flow Set**
27070000

hansgrohe

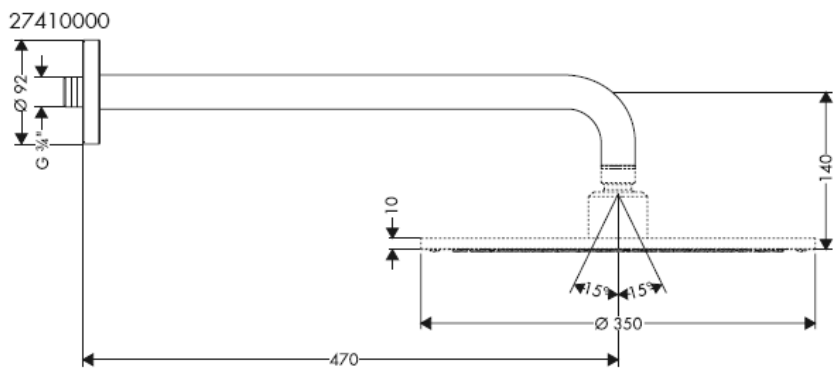
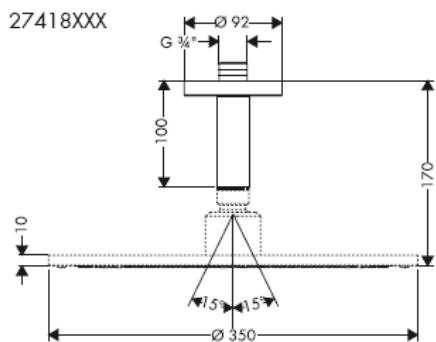
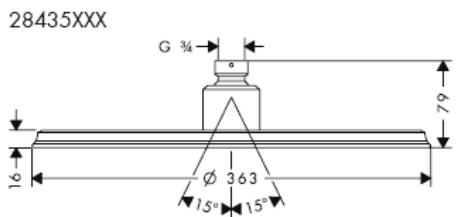
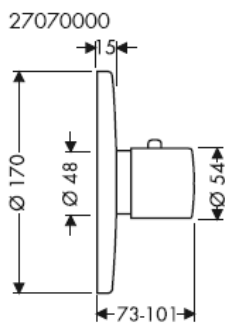
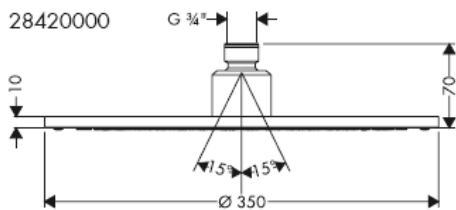

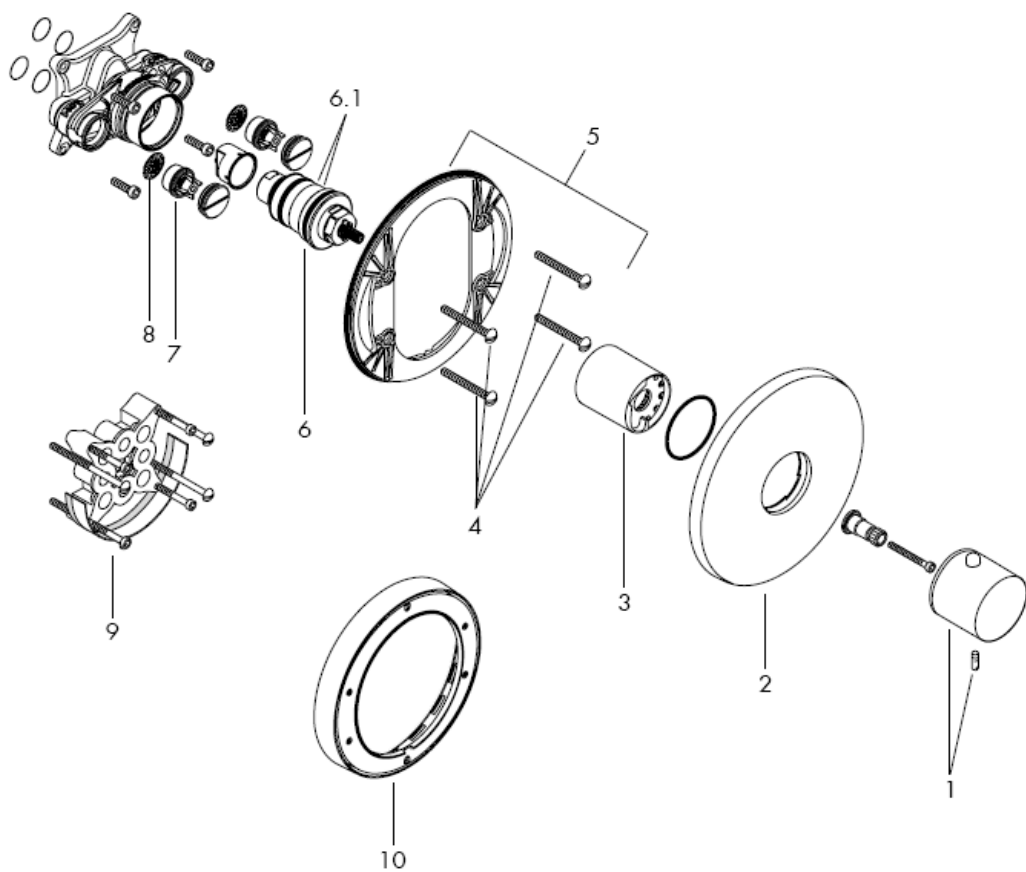

Mõõtude puhul arvestage võimalusel plaatide asetusega.

Vajalik seinatugevdus dušikinnituse jaoks

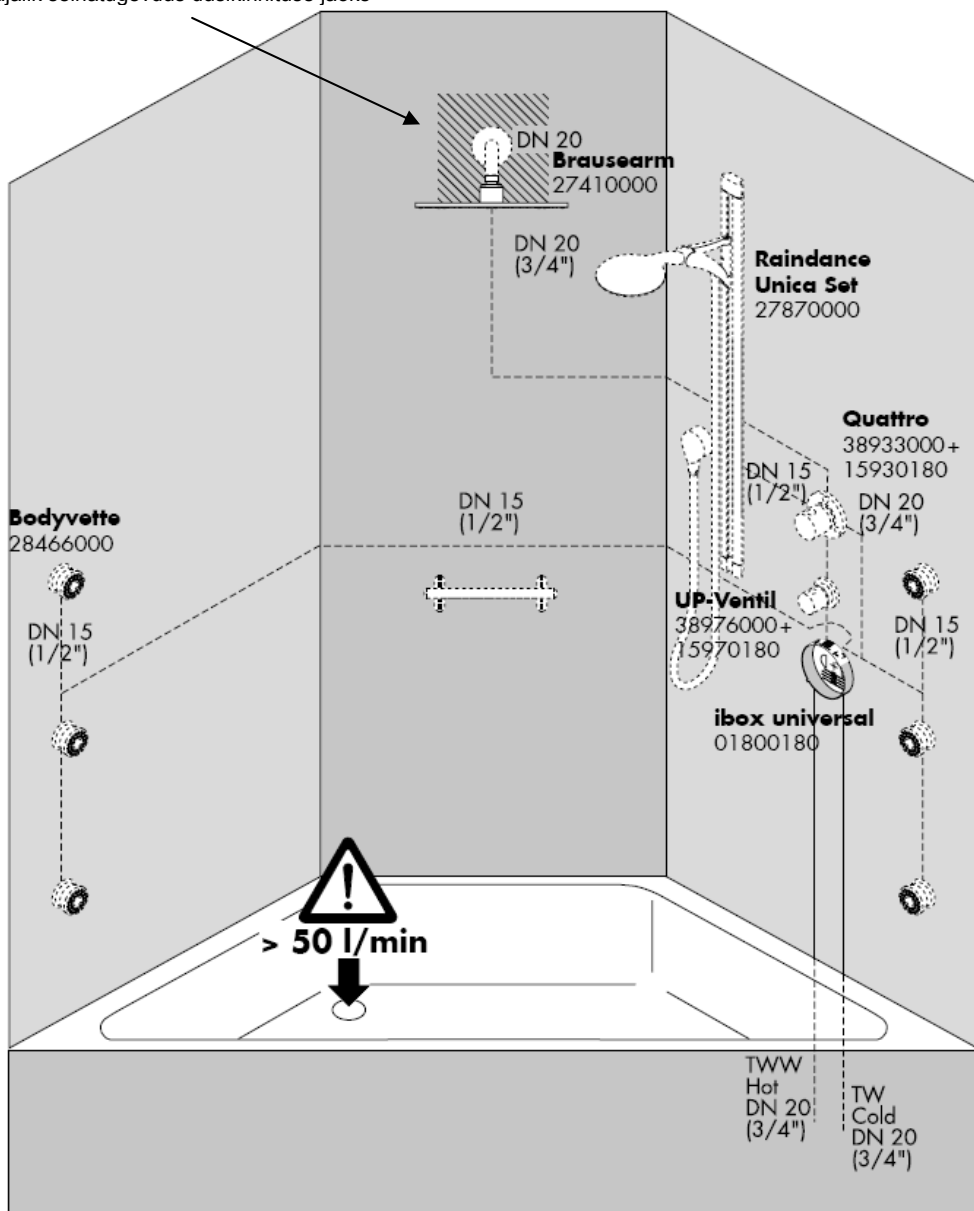

Alates • on funktsioneerimine garanteeritud

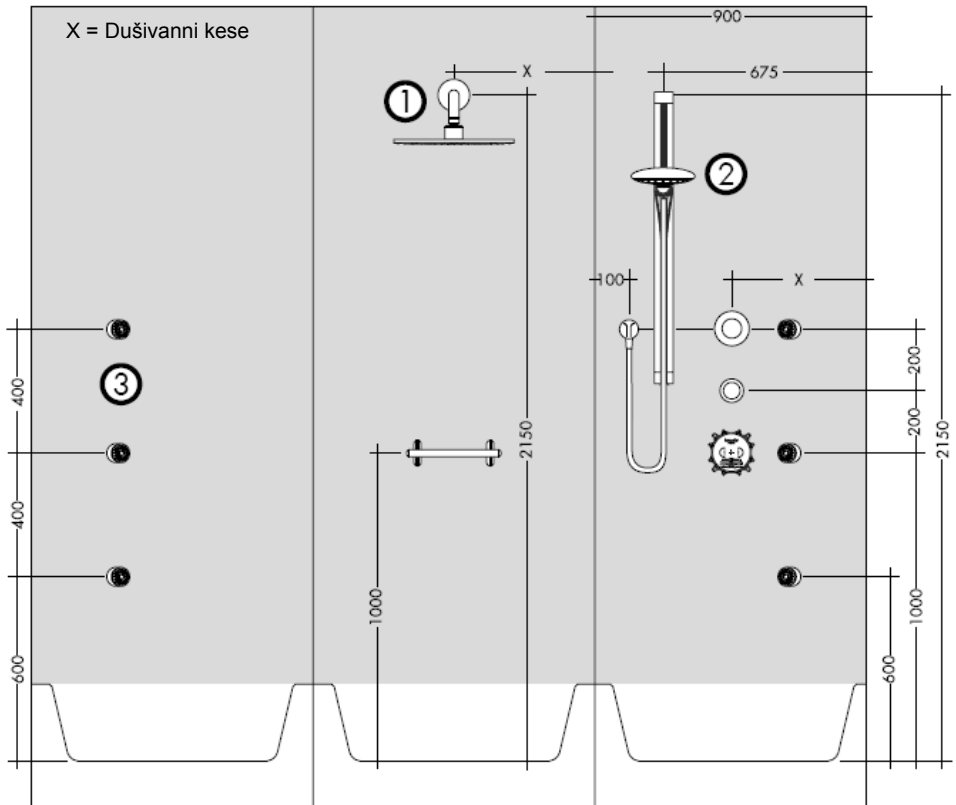
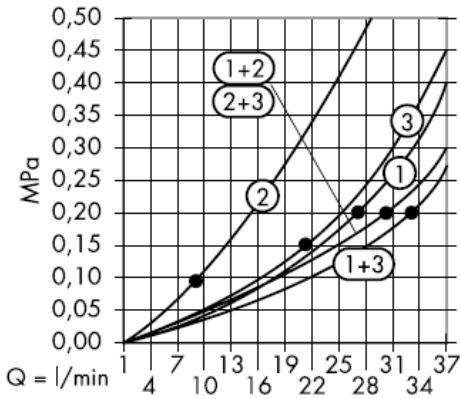

Vajalik seinatugevdus dušikinnituse jaoks

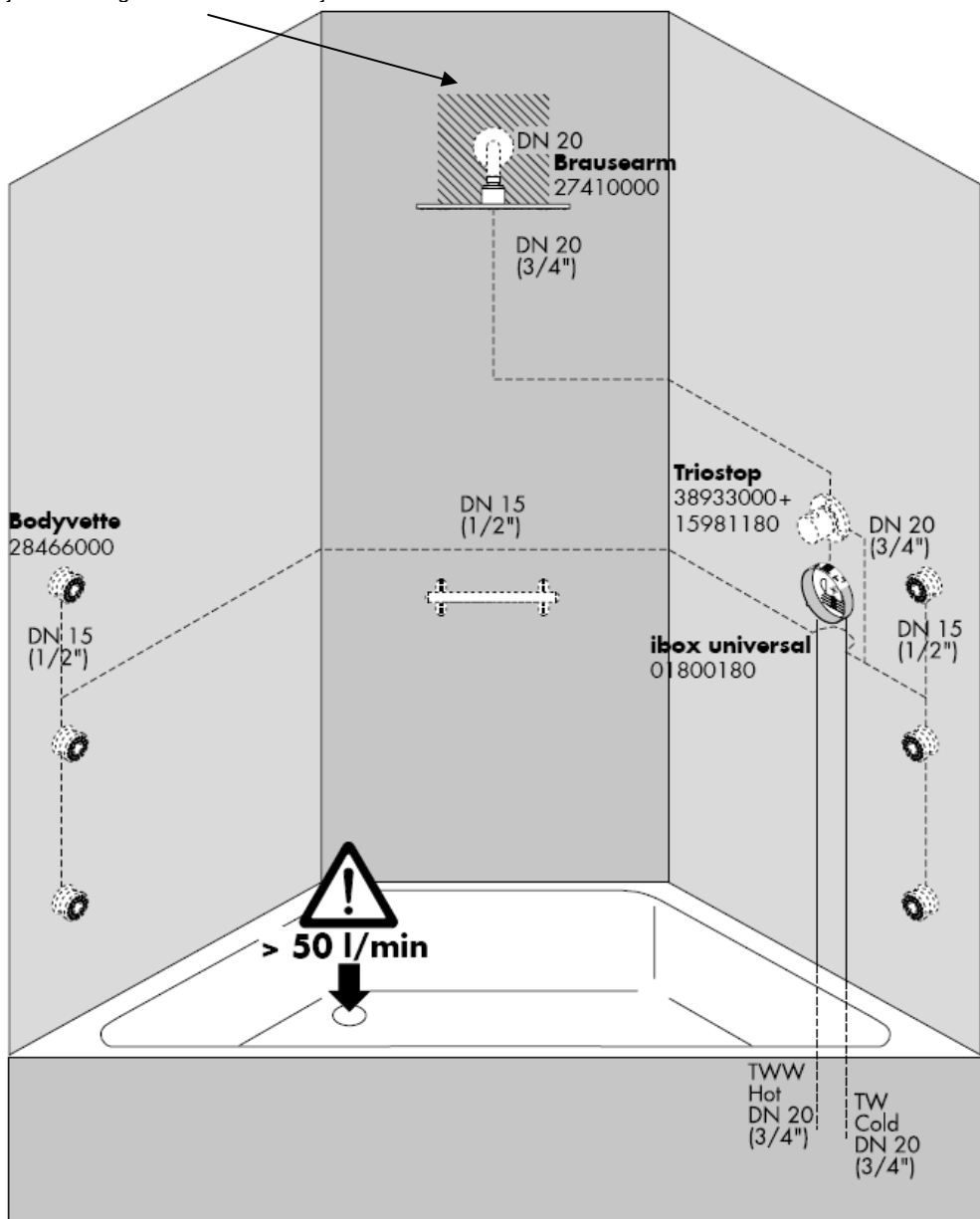

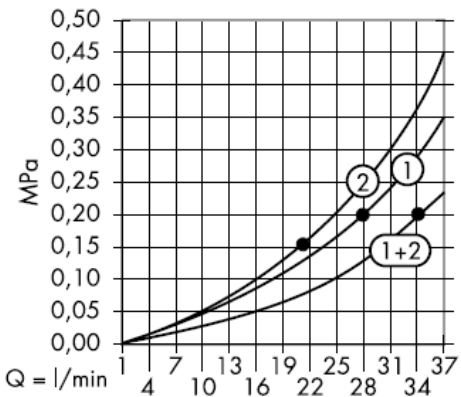

Alates • on funktsioneerimine garanteeritud

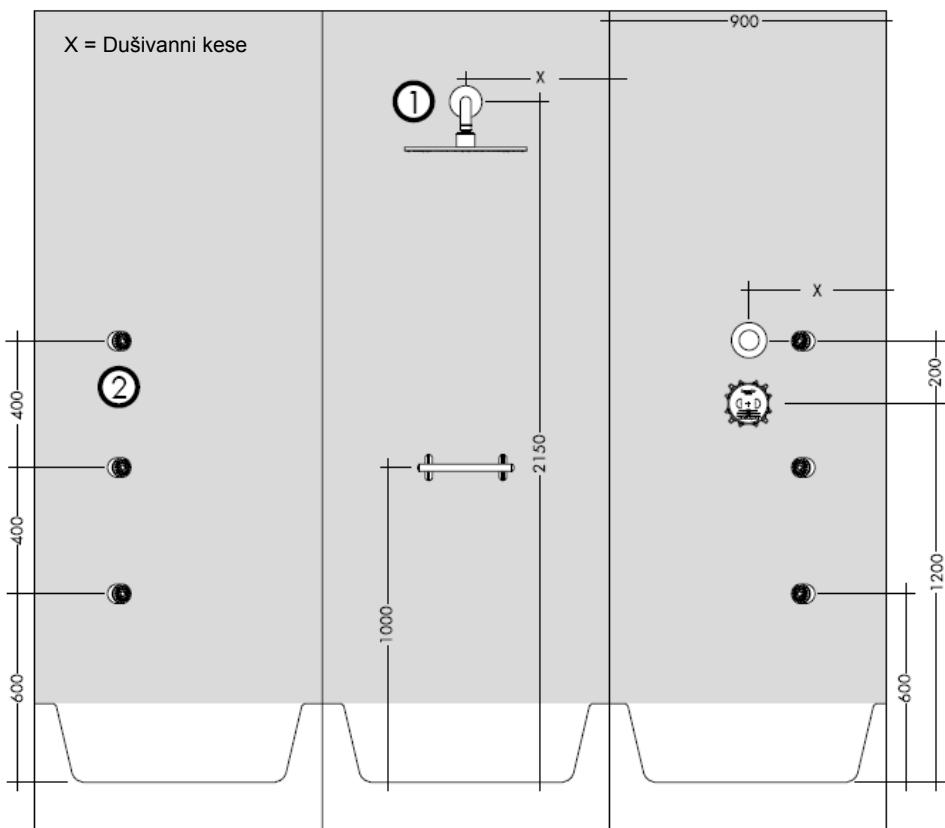

Vajalik seinatugevdus dušikinnituse jaoks

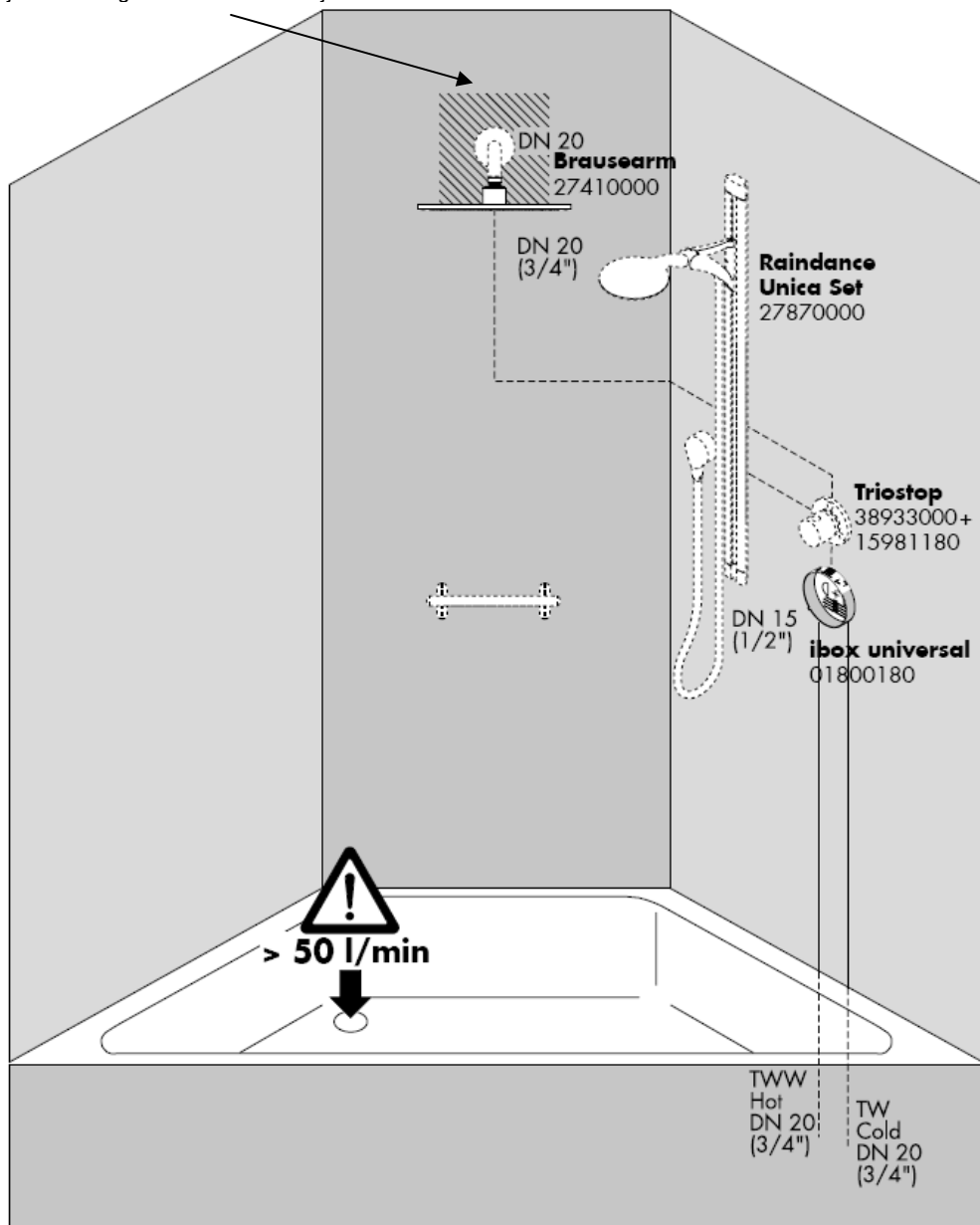

Alates • on funktsioneerimine garanteeritud

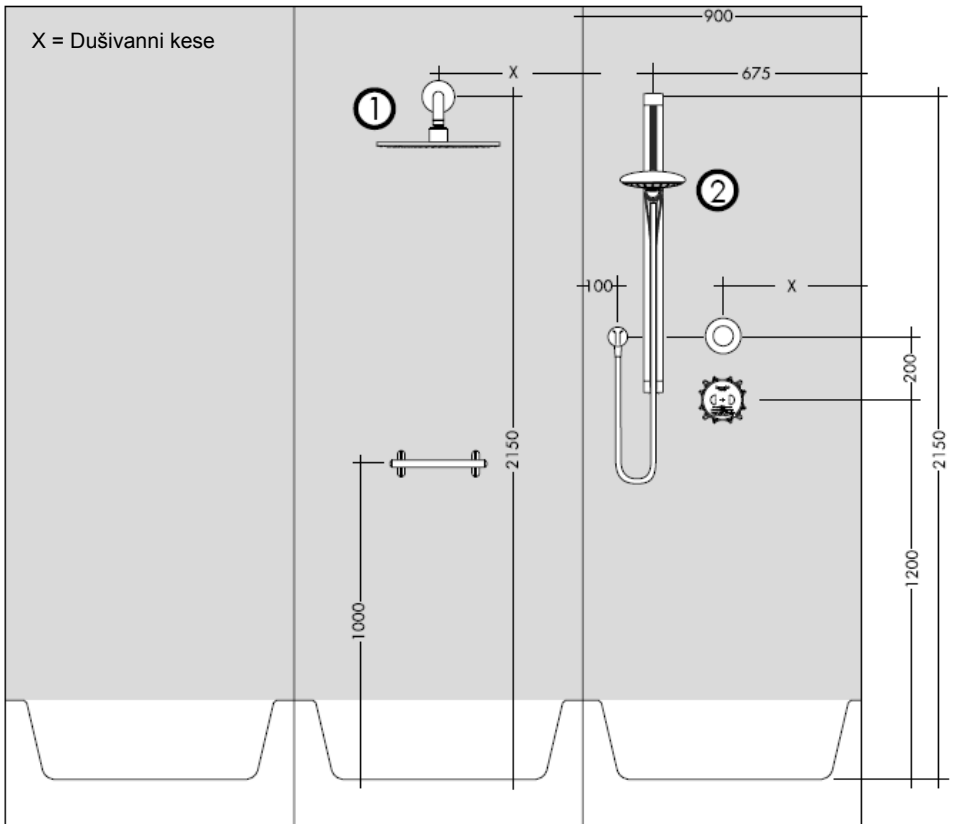
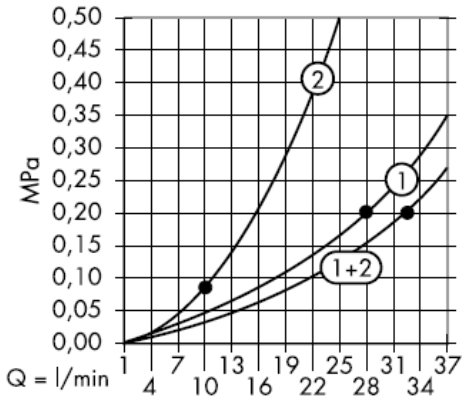

Vajalik seinatugevdus dušikinnituse jaoks

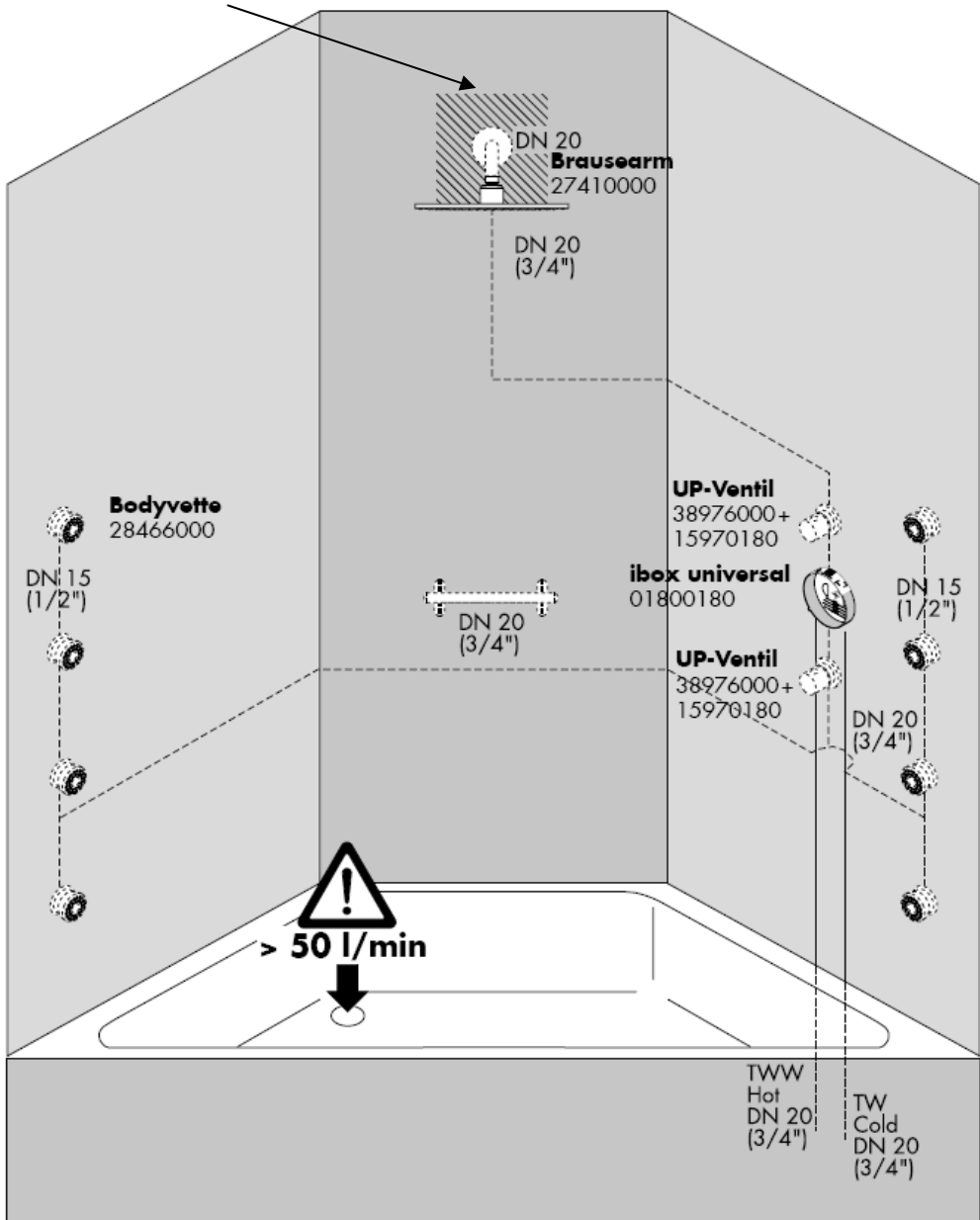

Alates • on funktsioneerimine garanteeritud

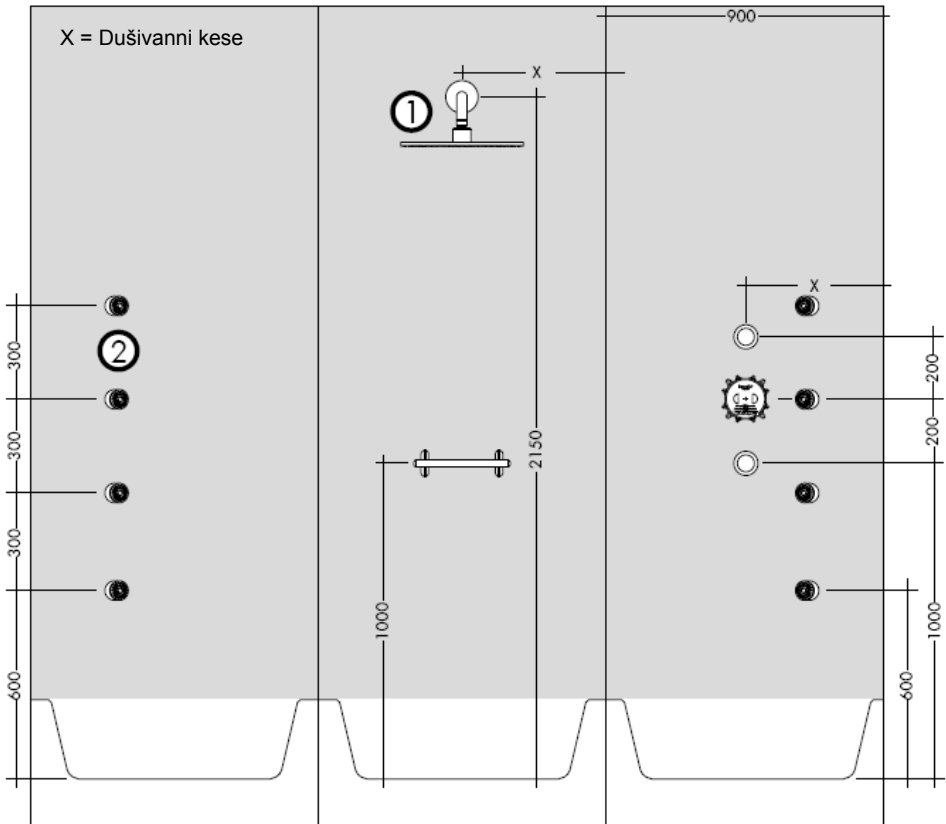
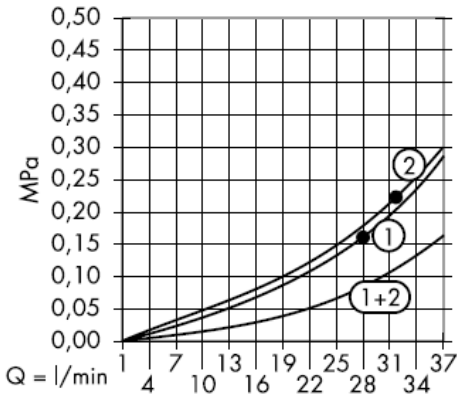

Vajalik seinatugevdus dušikinnituse jaoks

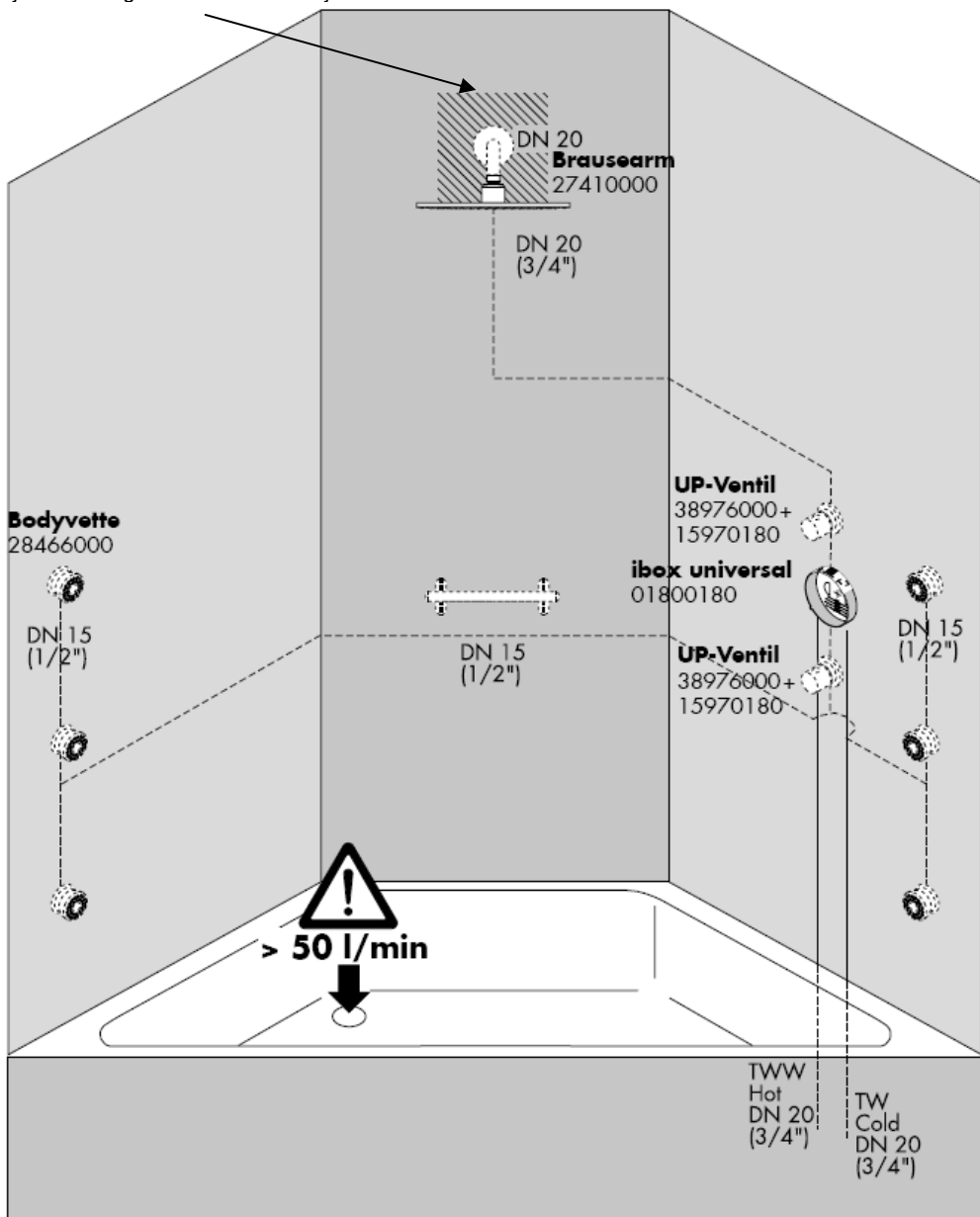

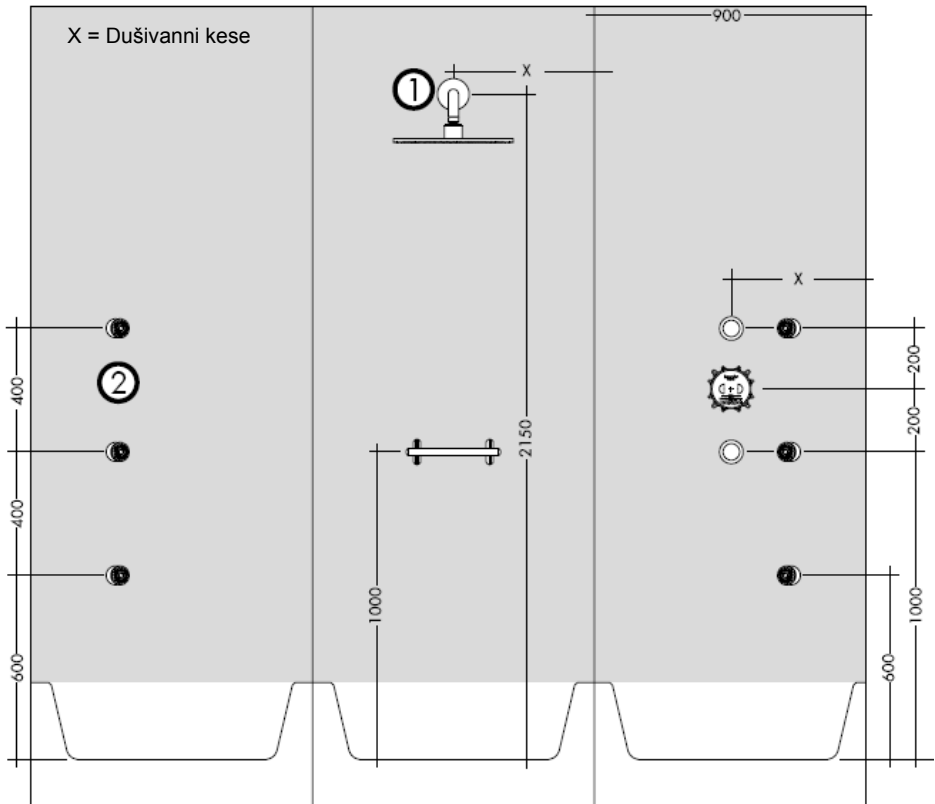
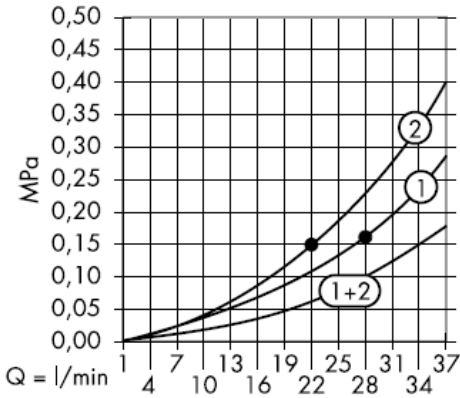

Vajalik seinatugevdus dušikinnituse jaoks

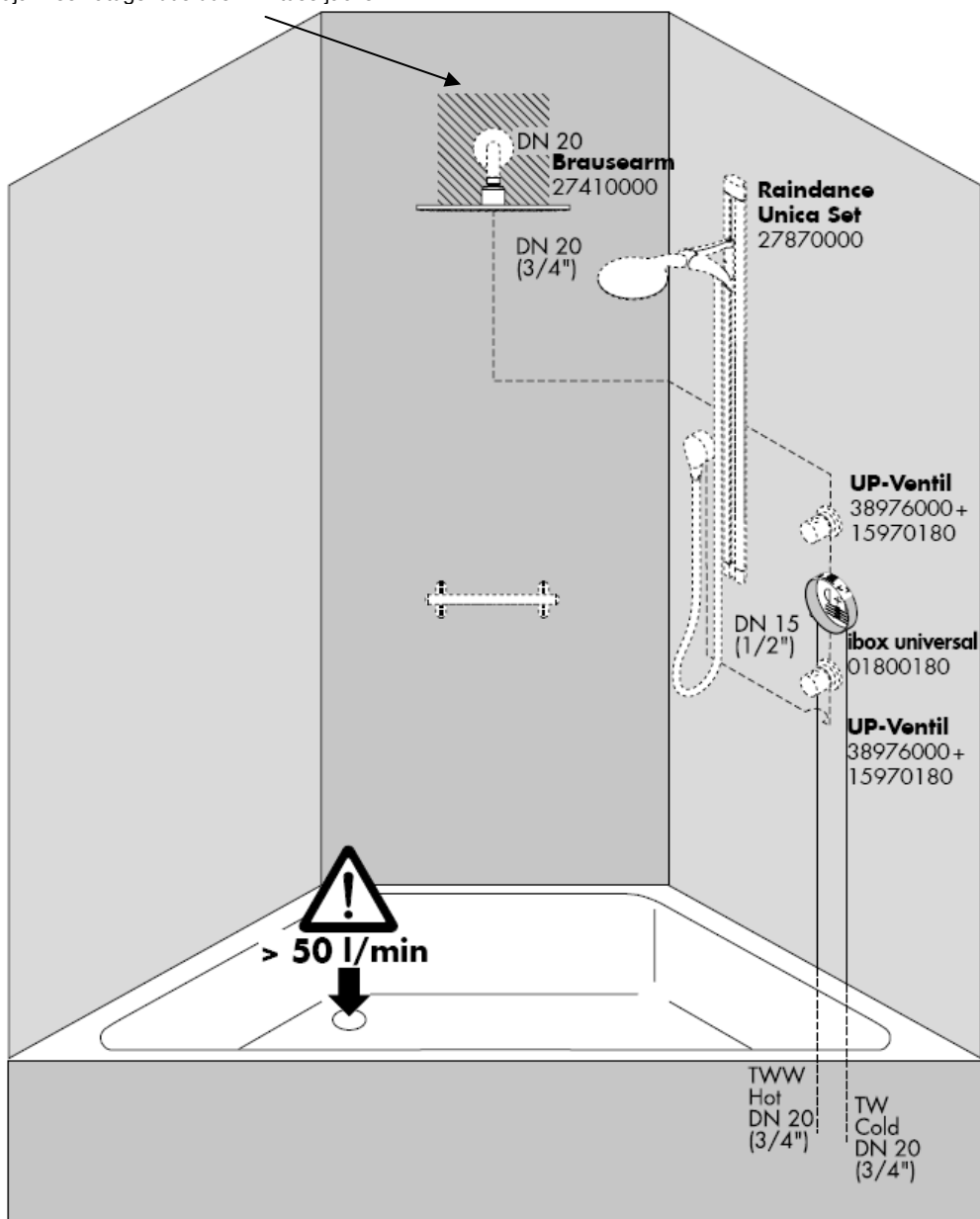

Vajalik seinatugevdus dušikinnituse jaoks

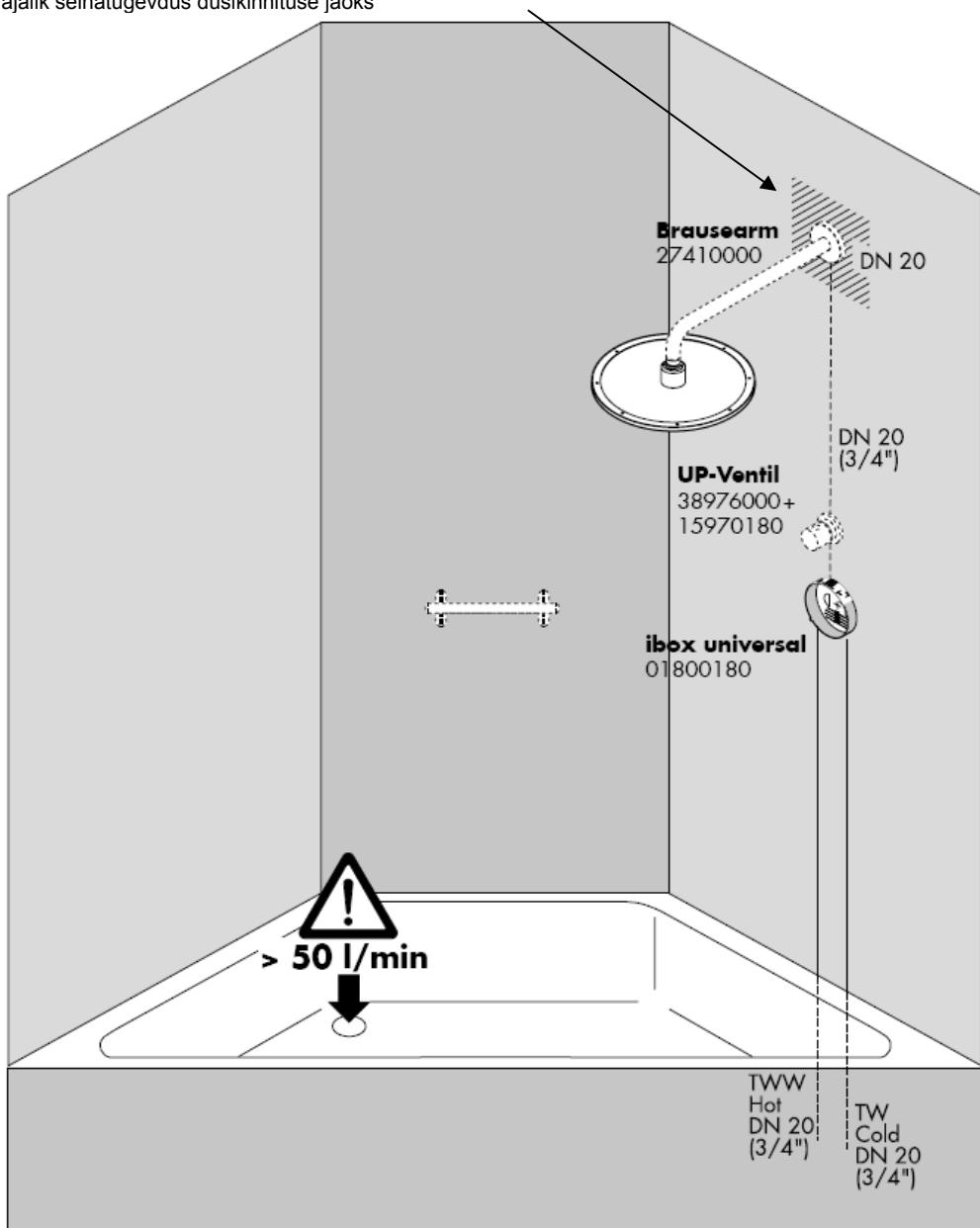

Alates • on funktsioneerimine garanteeritud

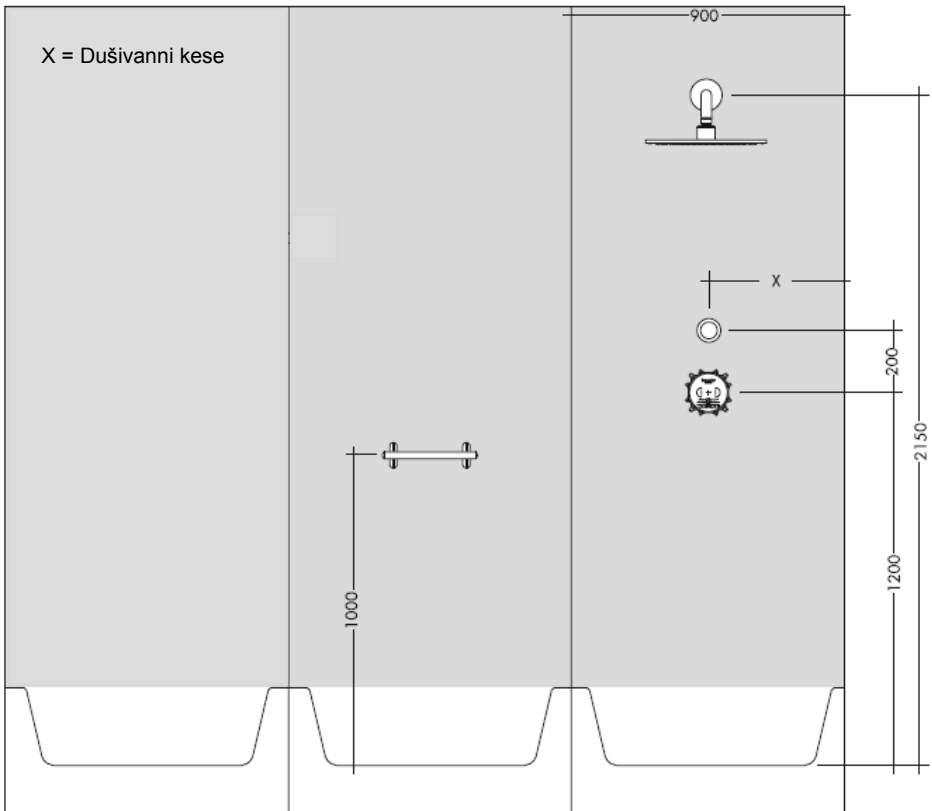
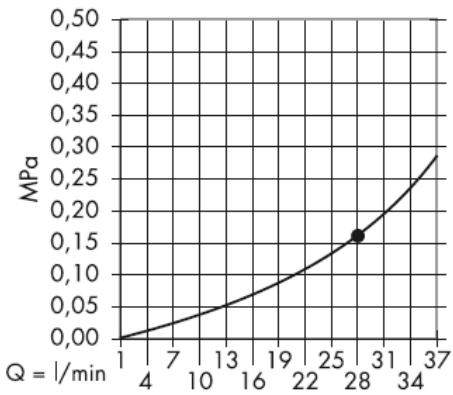

Vajalik seinatugevdus dušikinnituse jaoks

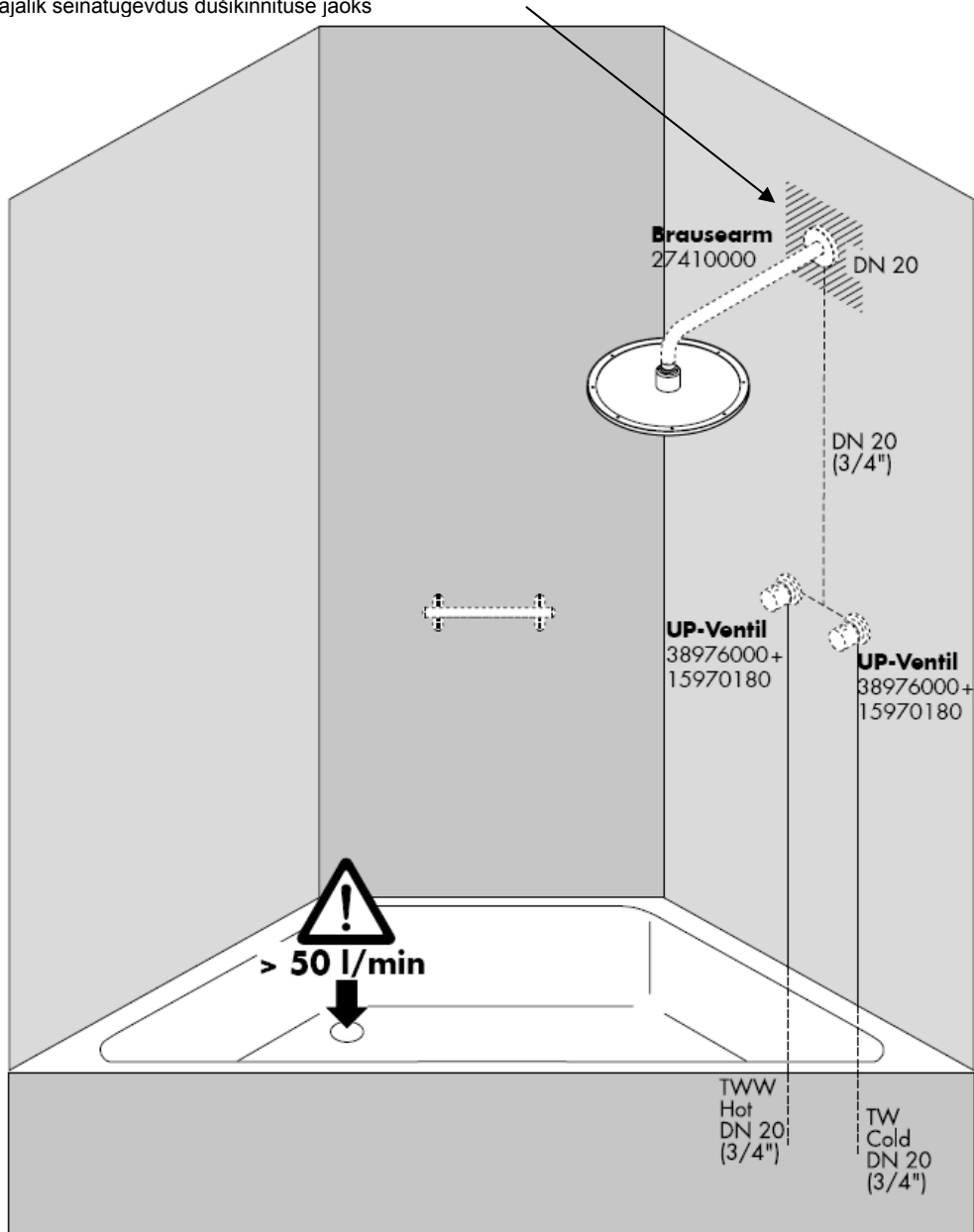

Alates • on funktsioneerimine garanteeritud

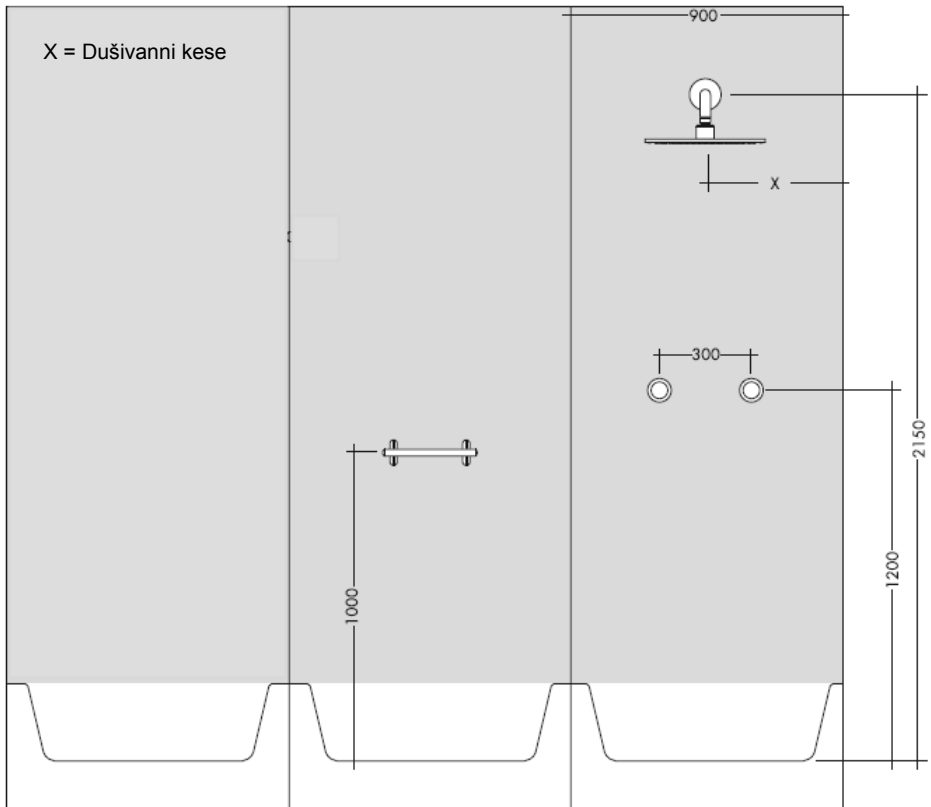
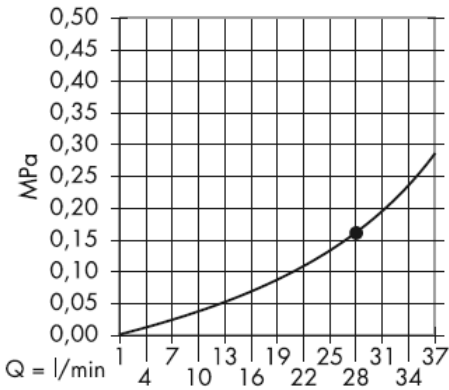

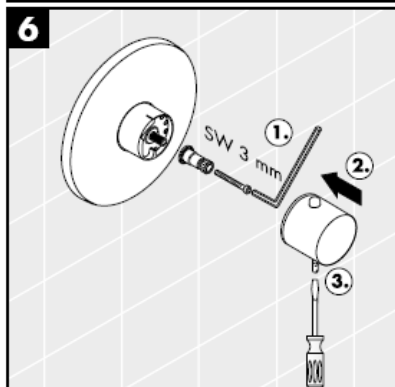
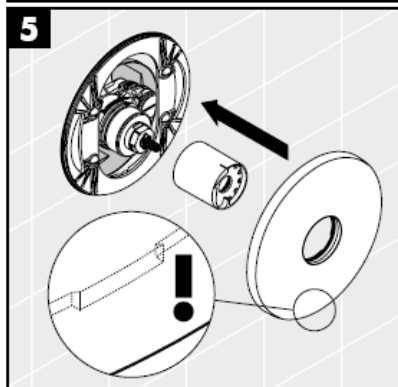
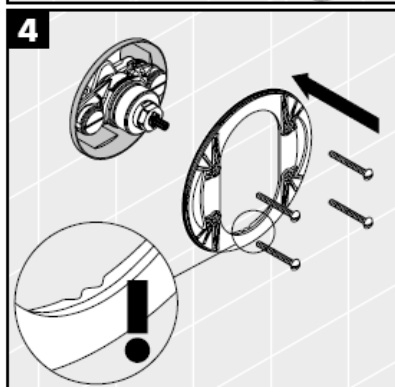
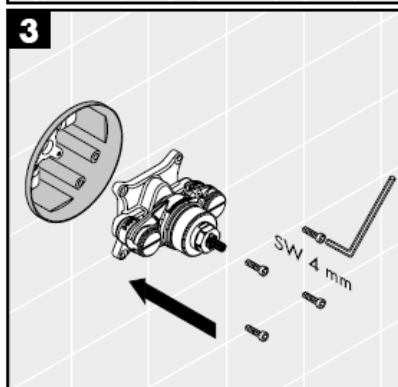
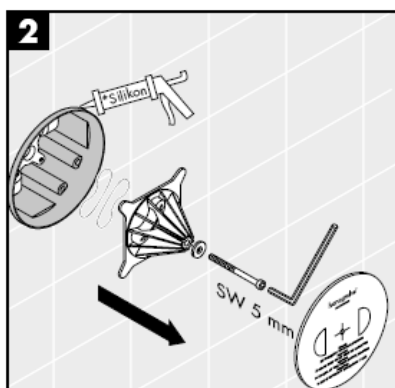
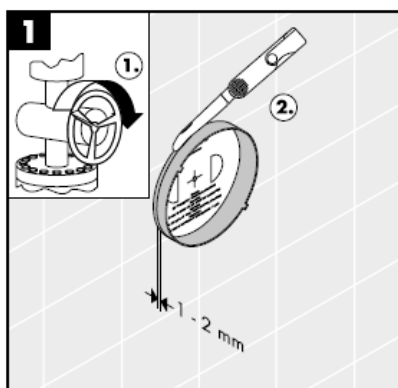

Silikon (äädikhappeta!)

Tänu ohutusfunktsioonile on võimalik soovitud maksimaaltemperatuuri eelnevalt sisestada (nt maks. 42 C).

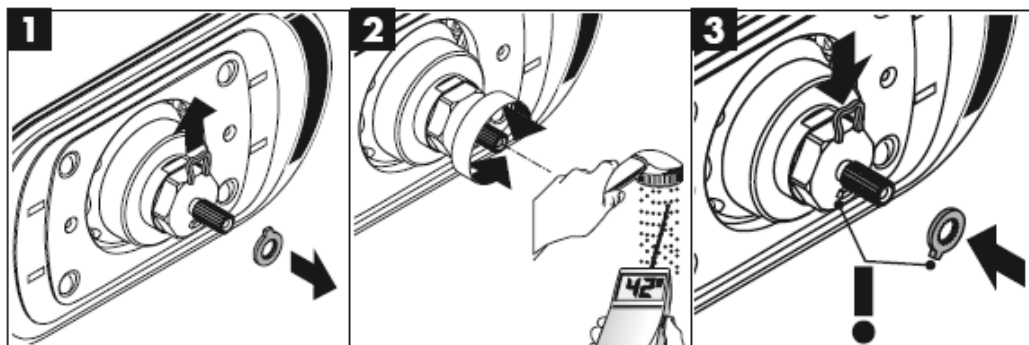

Reguleerimine

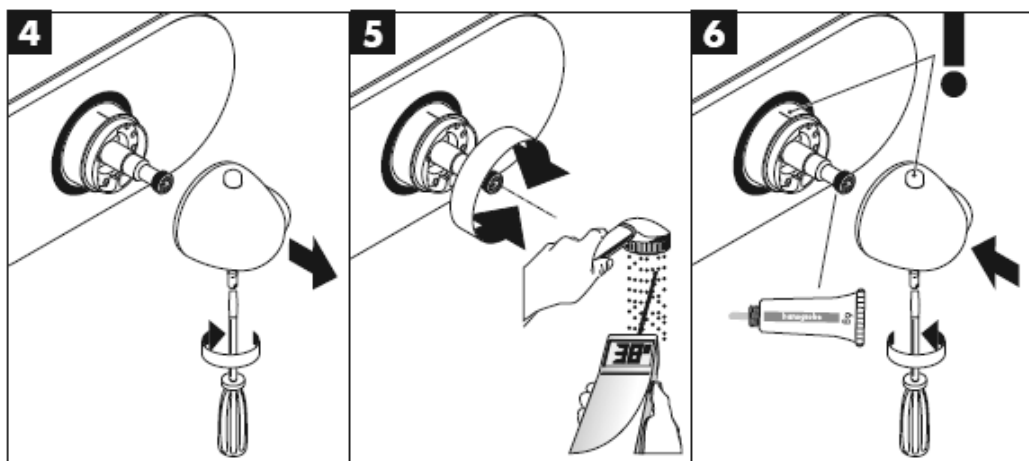



Kui dušš töötab, on selle kaal koos dušivarrega umbes 10 kg. Sellepärast võib kasutada ainult müüritise jaoks sobivat kinnitusmaterjali! Kaasasolevad kruvid ja tüüblid on ainult massiivse müüritise jaoks.

Kasutage ainult müüritise jaoks sobilikku kinnitusmaterjali! Kaasasolevad kruvid ja tüüblid on ette nähtud üksnes tavalisele müüritisele.

Äravoolu jõudlus peab olema piisav.

Optimaalne funktsioneerimine on garanteeritud ainult koos termostaatidega Hansgrohe High Flow.

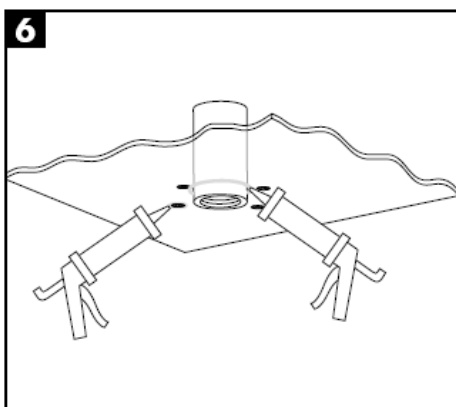
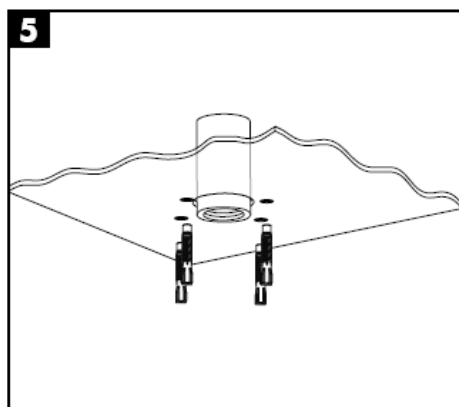
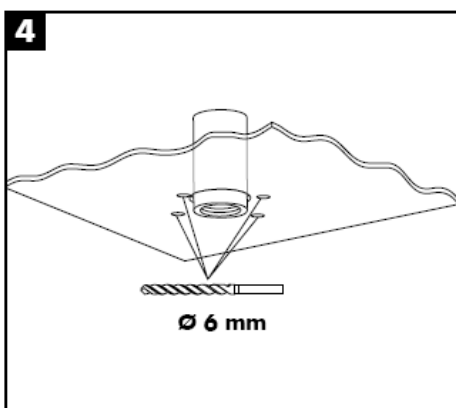
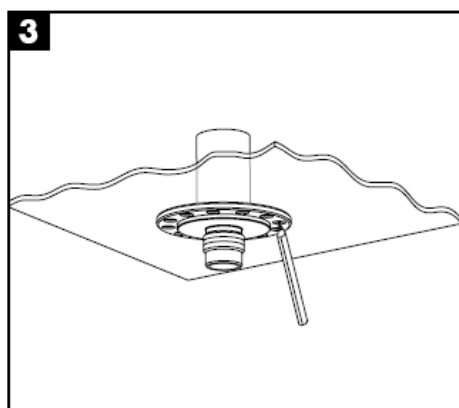
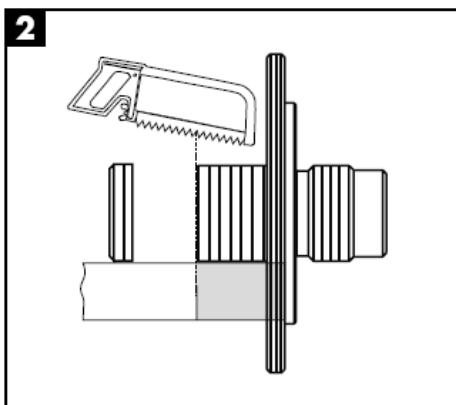
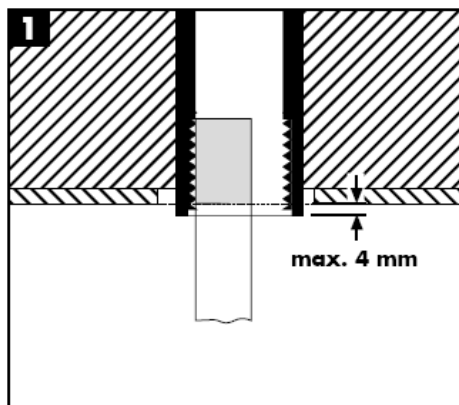

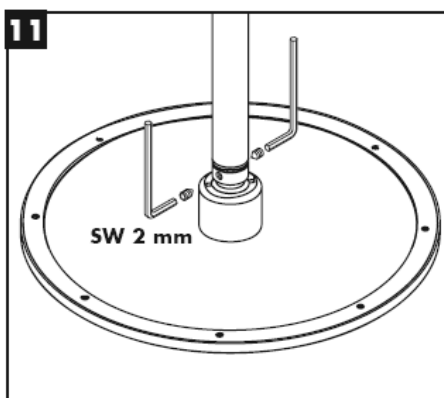
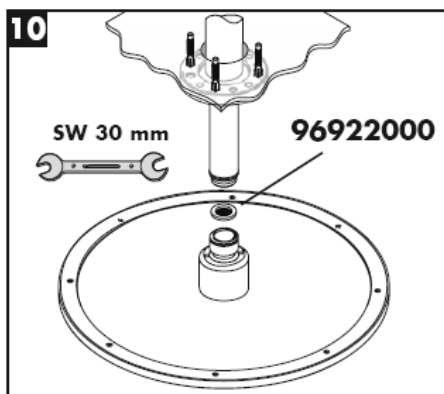
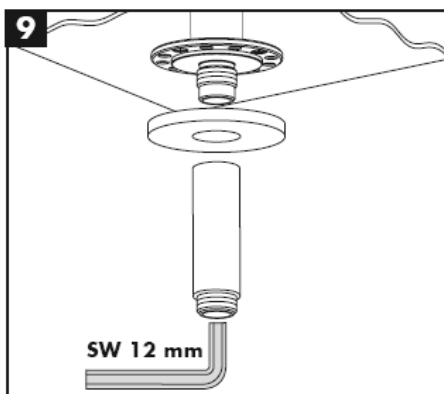
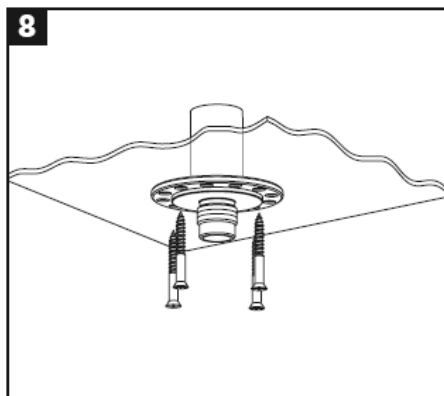
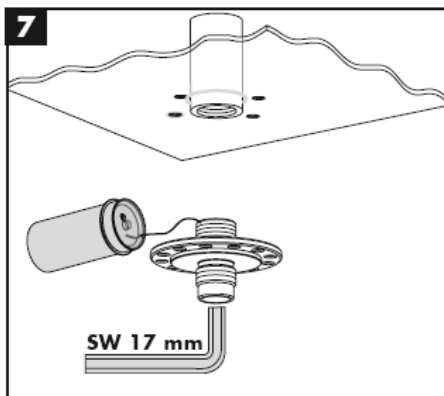

Kaitsmaks dušši torust tuleva mustuse eest, on vaja paigaldada dušiga kaasasolev mustusesõel. Sissetulev mustus võib funktsioneerimist kahjustada ja/või rikkuda duši detaile. Sellest tulenevate kahjude eest Hansgrohe ei vastuta.

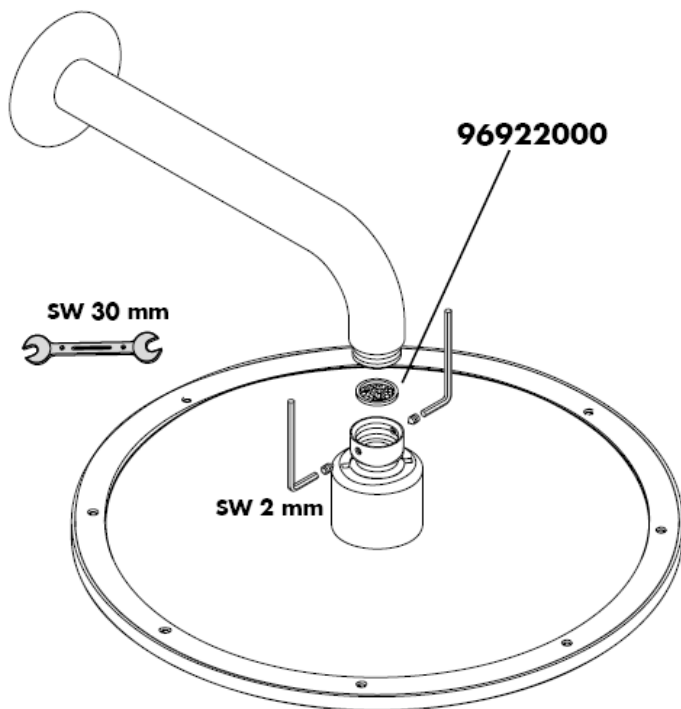

Paigaldamine

Tähelepanu! Segisti paigaldamine, loputamine ja kontroll peab toimuma vastavalt kehtivatele normidele!

Reguleerimine

Kui väljavoolu temperatuur erineb termostaati sisestatust, on tarvis seda reguleerida. Selleks pöörake skaalaga pidet, kuni väljavoolu vesi on 38 C. Eemaldage pideme kruvi, pöörake paigaldusnupp 38 C peale. Asetage pide peale ja kruvide kinni (vt lk 22).

Temperatuuri piirang

Turvatõkesti temperatuuripiirang on 38 C (põletuse oht). Kui soovite kõrgemat temperatuuri, on võimalik ohutusnupu sissevajutamisega 38 C piirang ületada.

Turvafunktsioon

Tänu ohutusfunktsioonile on võimalik soovitud maksimaaltemperatuuri eelnevalt sisestada (nt maks. 42 C). vt lk 21.

Tehnilised andmed

Töörõhk	max. 1 MPa
Soovitatav töörõhk:	0,1 – 0,5 MPa
Kontrollsurve:	1,6 MPa
(1 MPa = 10 baari = 147 PSI)	
Kuuma vee temperatuur:	max.80° C
Soovitatav kuuma vee temperatuur:	65° C
Läbivool:	ca.58 l/min 0,3 MPa

Hooldus

Termostaadid ei vaja eri hooldust. Tagasilöögiklappide toimimist tuleb kooskõlas riiklike ja regionaalsete määrustega regulaarselt kontrollida vastavalt standardile DIN EN 1717 (DIN 1988 - kord aastas). Kontrollige sel puhul ka mustusefiltreid, mis asuvad MTC-regulaatori (6.1) peal. MTC-regulaatori paigaldamise järel kontrollige kindlasti ka väljavoolava vee temperatuuri, nagu kirjeldatud teema "Reguleerimine" all. Vaadake kindlasti enne järele, kas kuum vesi on sisse lülitatud ning kas maksimaalselt kuum vesi on veevõtukohal saadaval.

Termostaadi hea toimimise tagamiseks on tarvis termostaat keerata aeg-ajalt päris kuuma ja päris külma peale.

Varuosad vt lk 3

1	termostaadiga pide	38391000
2	äärrik	96452000
3	hülss	97439000
4	kinnituskruvid	96454000
5	alusplaat	96447000
6	termoregulaator	96633000
7	filter	97367000
8	tagasilöögiklapp	96655000
9	pikendus 25 mm	13595000
10	pikendus 25 mm	13596000

Estonia

Rike	Põhjus	Lahendus
Vähe vett	-Surve ebapiisav -Regulaatori filter on määrduanud -Duši sõeltihend must	-Kontrollige vee survet torudes (kui pump on installeeritud, kontrollige kas pump töötab) -Puhastage filtrid -Puhastage duši ja vooliku vaheline sõeltihend
Ristvool, soe vesi surutakse suletud segisti korral külmaveetoru või vastupidi, kui segisti on suletud	-Tagasilöögiklapp määrduanud/katki	-Tagasilöögiklapp välja vahetada
Väljavoolava vee temperatuur ei vasta seatud temperatuurile	-Termostaati pole reguleeritud -Sooja vee temperatuur liiga madal	-Reguleerige termostaati -Tõstke sooja vee temperatuuri 42 C kuni 65 C
Termoregulatsioon pole võimalik	-Enota za uravnavanje temperature je umazana ali poapnena -Paigaldage funktsiooniblokk 180 pöördega	-Uuel paigaldusel põhikorpuse valesi ühendatud (peab olema külm paremal, soe vasakul) või 180 pööratud -Ohutusnupp ei tööta
Vedru on vigastatud või veaga	-Puhastage ning määrige kergelt vedru või nuppu, vajadusel vahetage ära -Ohutusnupp on lupjunud	-Puhastage ning määrige kergelt vedru või nuppu, vajadusel vahetage ära -Puhastage ning määrige kergelt vedru või nuppu, vajadusel vahetage ära

Kontrollsertifikaat

	P-IX	DVGW	SVGW	WRSA	KIWA	ACS	NF
27070000						X	
27418XXX							
28420000						X	
28435XXX						X	

Puhastamine

Lihtsalt puhas: lupja saab nappudelt lihtsalt maha hõõruda.

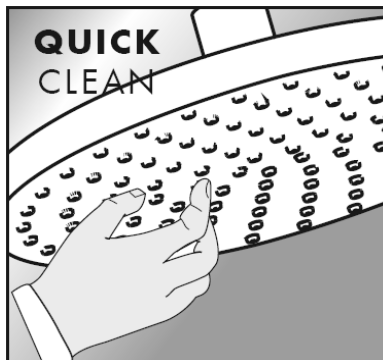

Hooldusjuhend

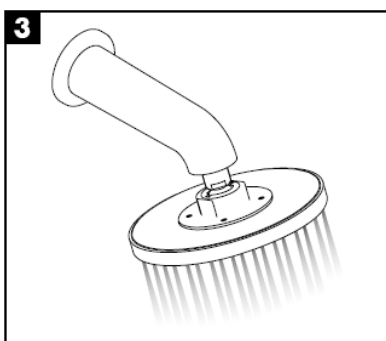
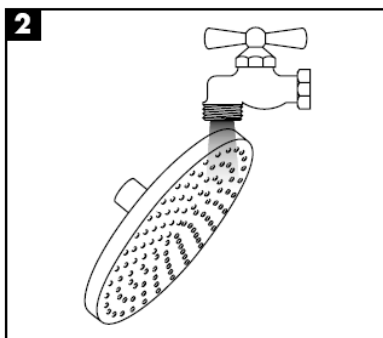
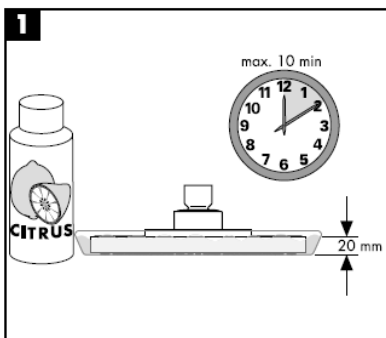

hansgrohe

Montāžas instrukcija



27418XXX

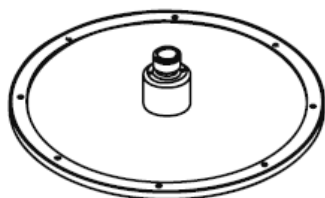

Raindance Royale AIR
28420000

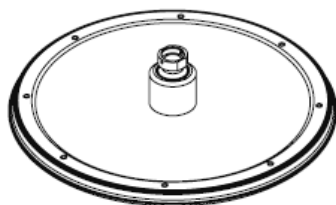

Raindance Royale Classic AIR
28435XXX

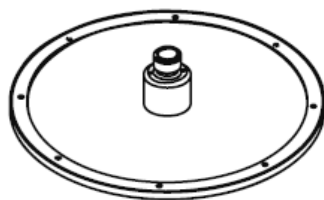

**Raindance Royale
High Flow Set**
27070000

hansgrohe

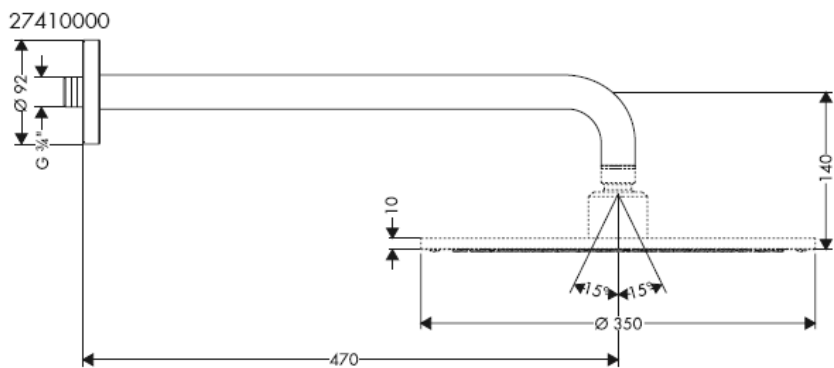
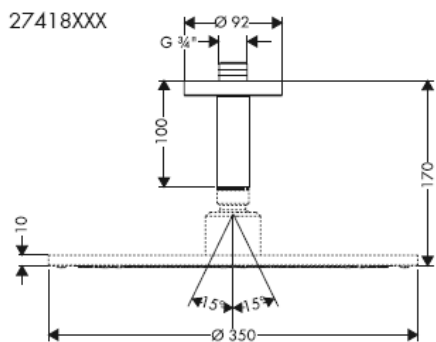
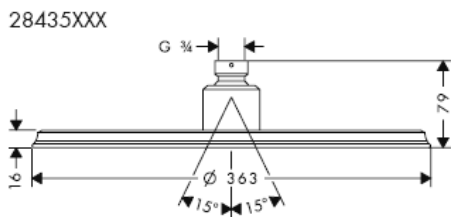
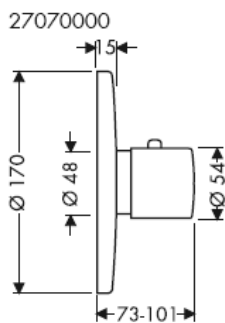
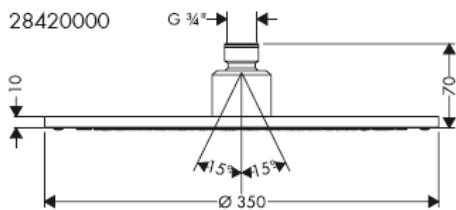

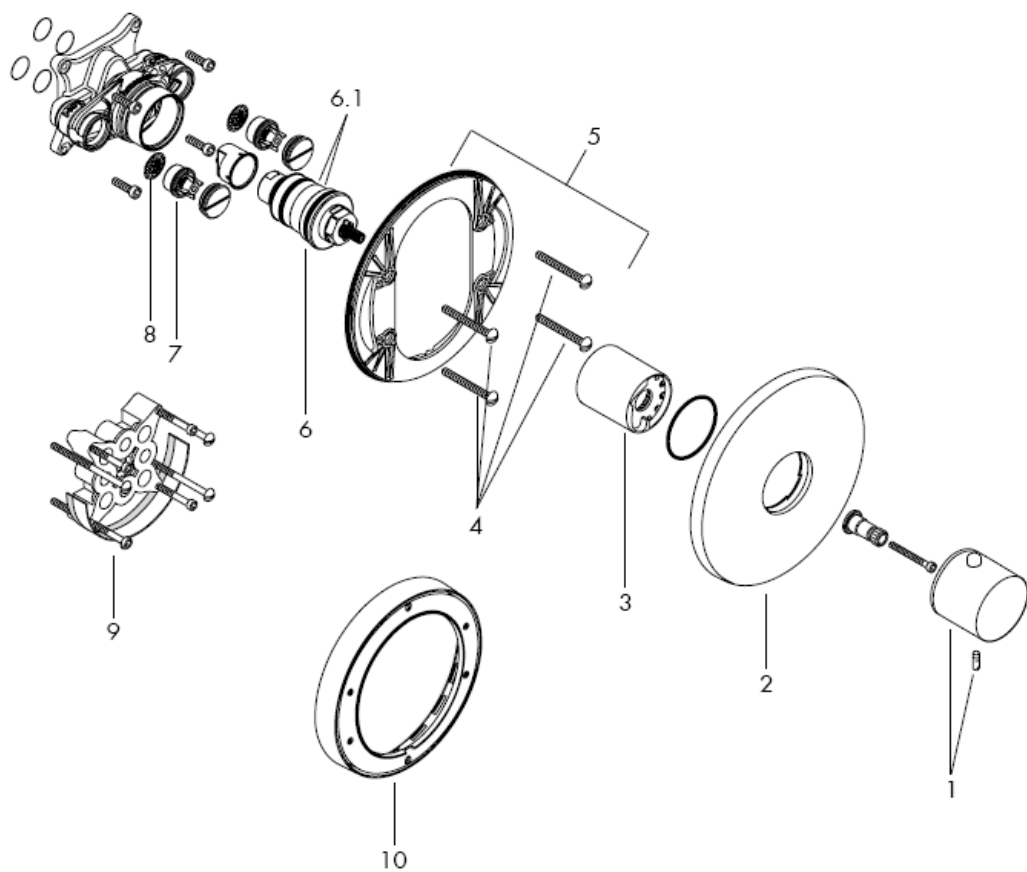

Izmērus pēc iespējas pielīdzināt fīžu rakstam.

Dušas klausulei nepieciešams sienas stiprinājums

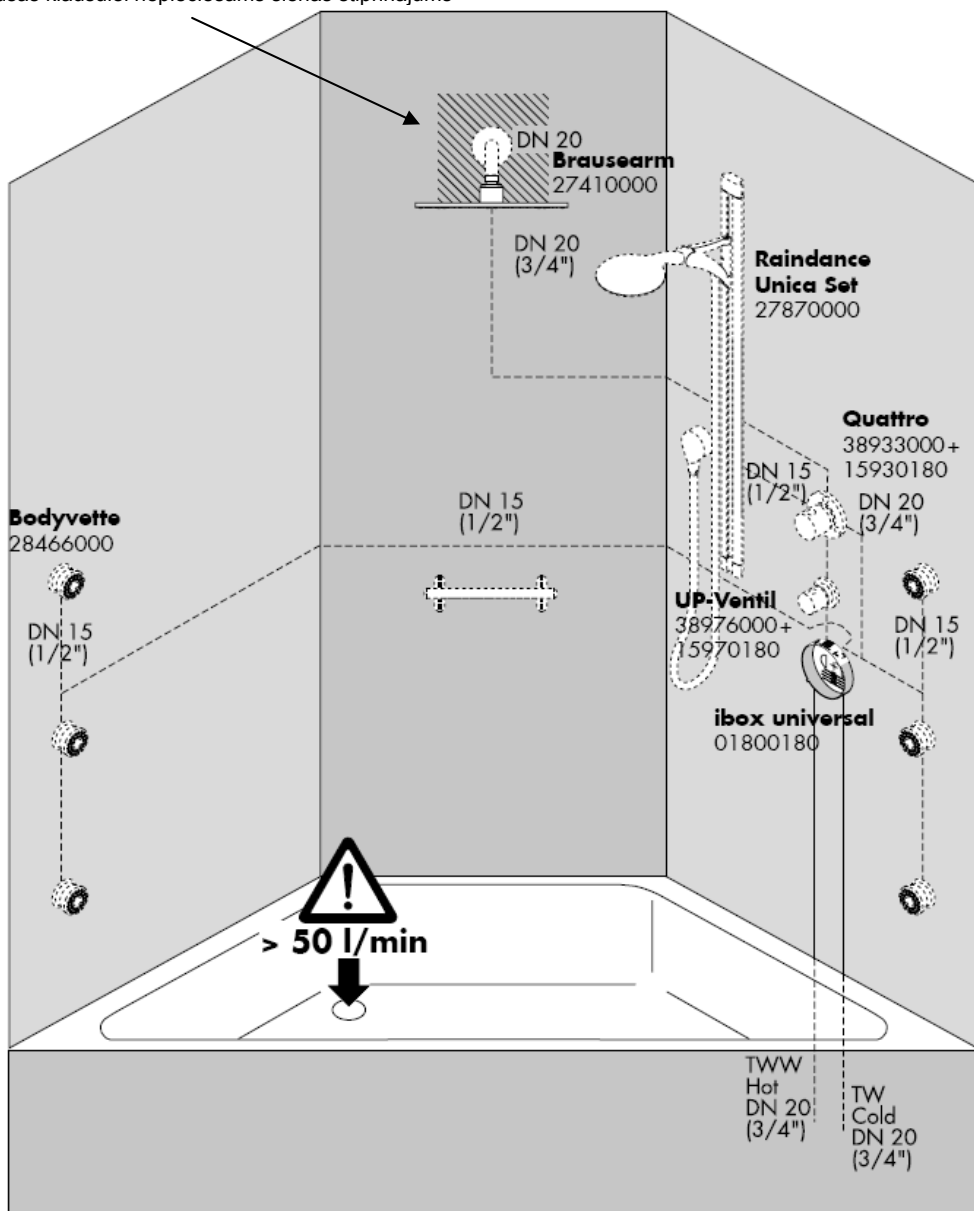

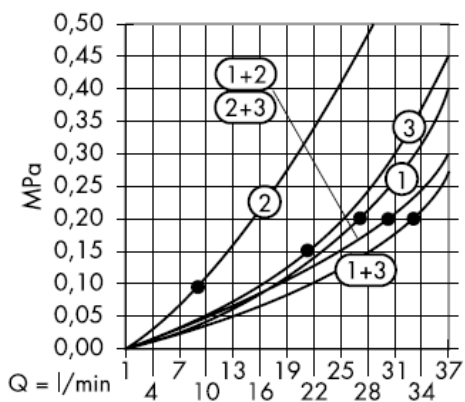

No • funkcija nodrošināta

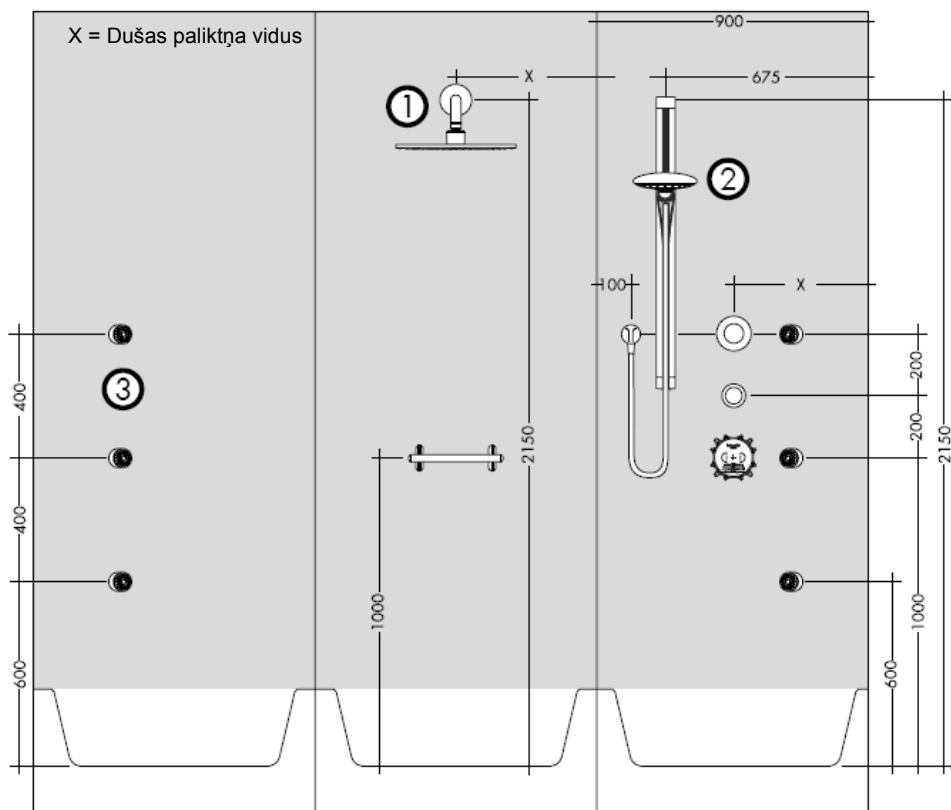

Dušas klausulei nepieciešams sienas stiprinājums

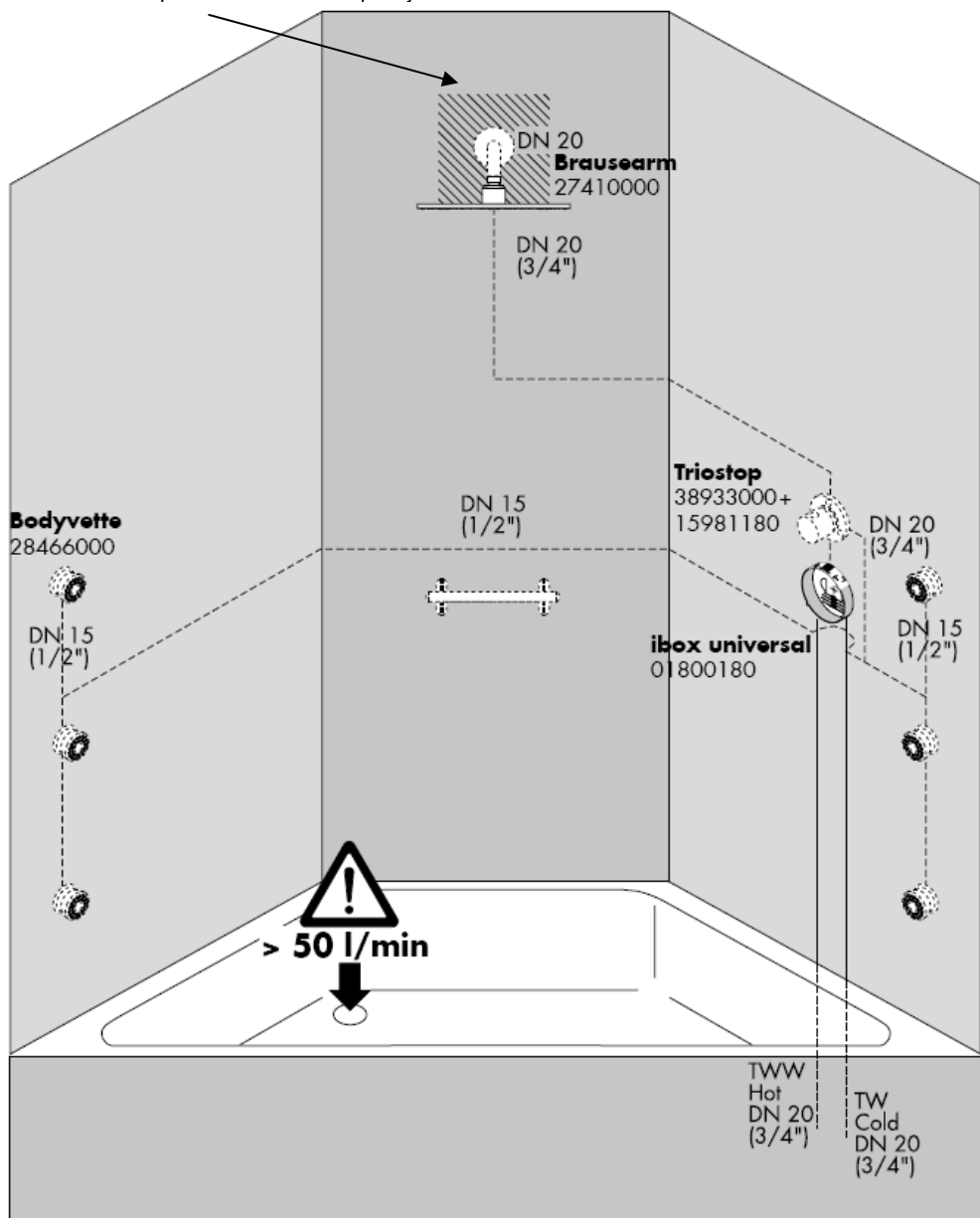

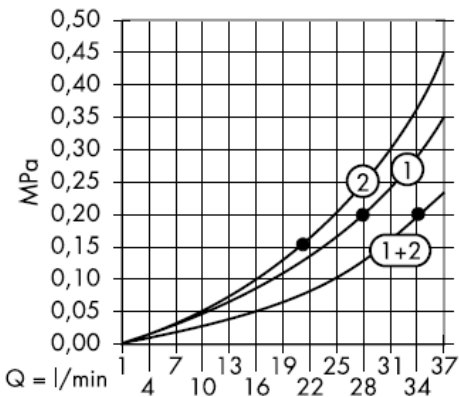

No • funkcija nodrošināta

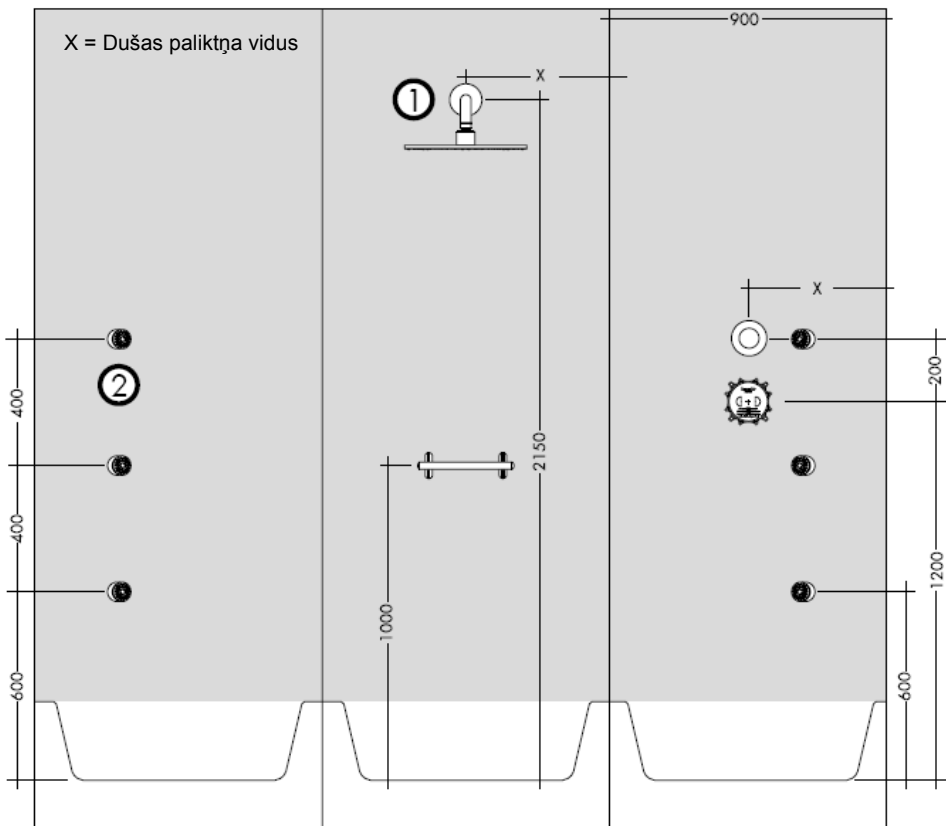

Dušas klausulei nepieciešams sienas stiprinājums

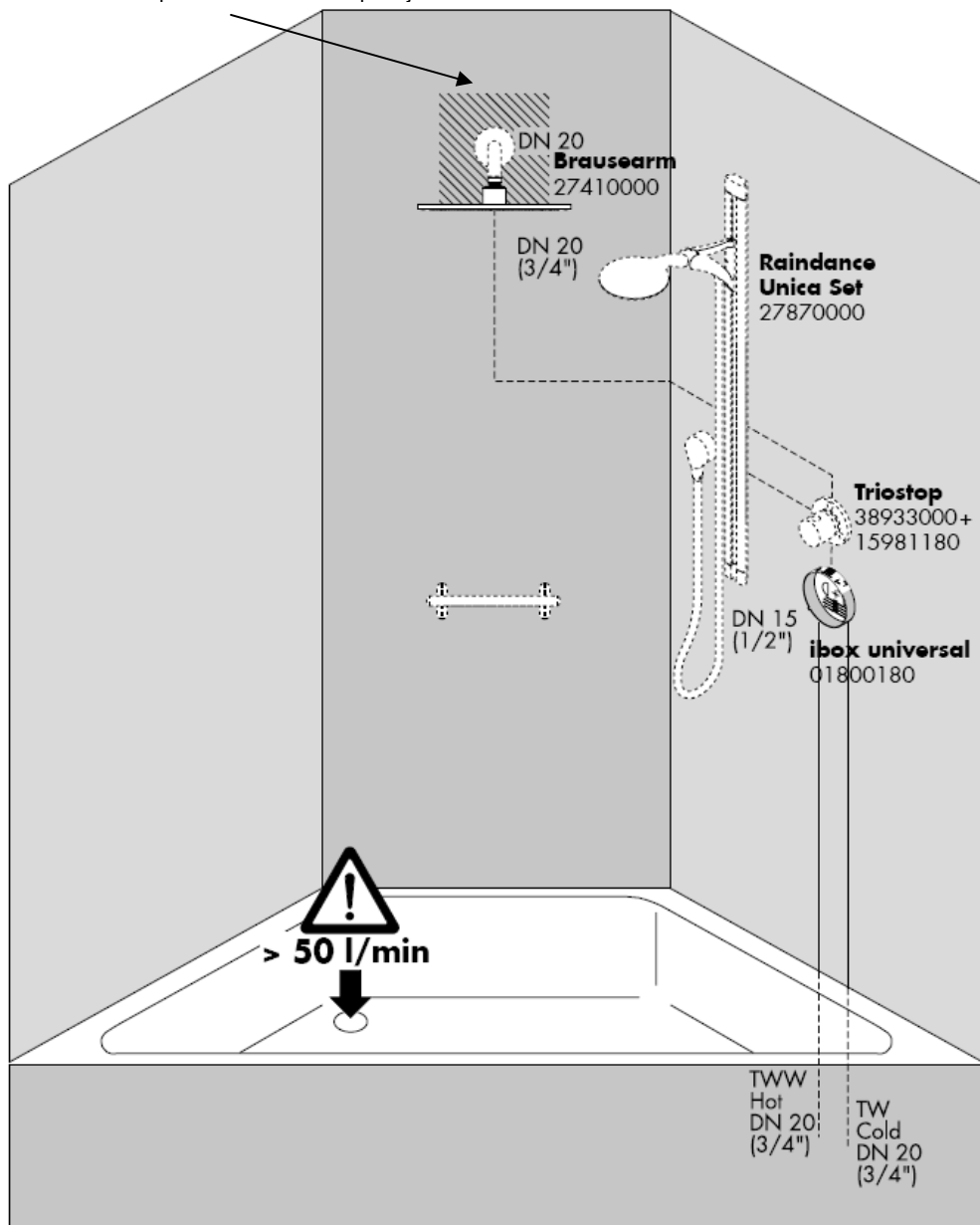

Dušas klausulei nepieciešams sienas stiprinājums

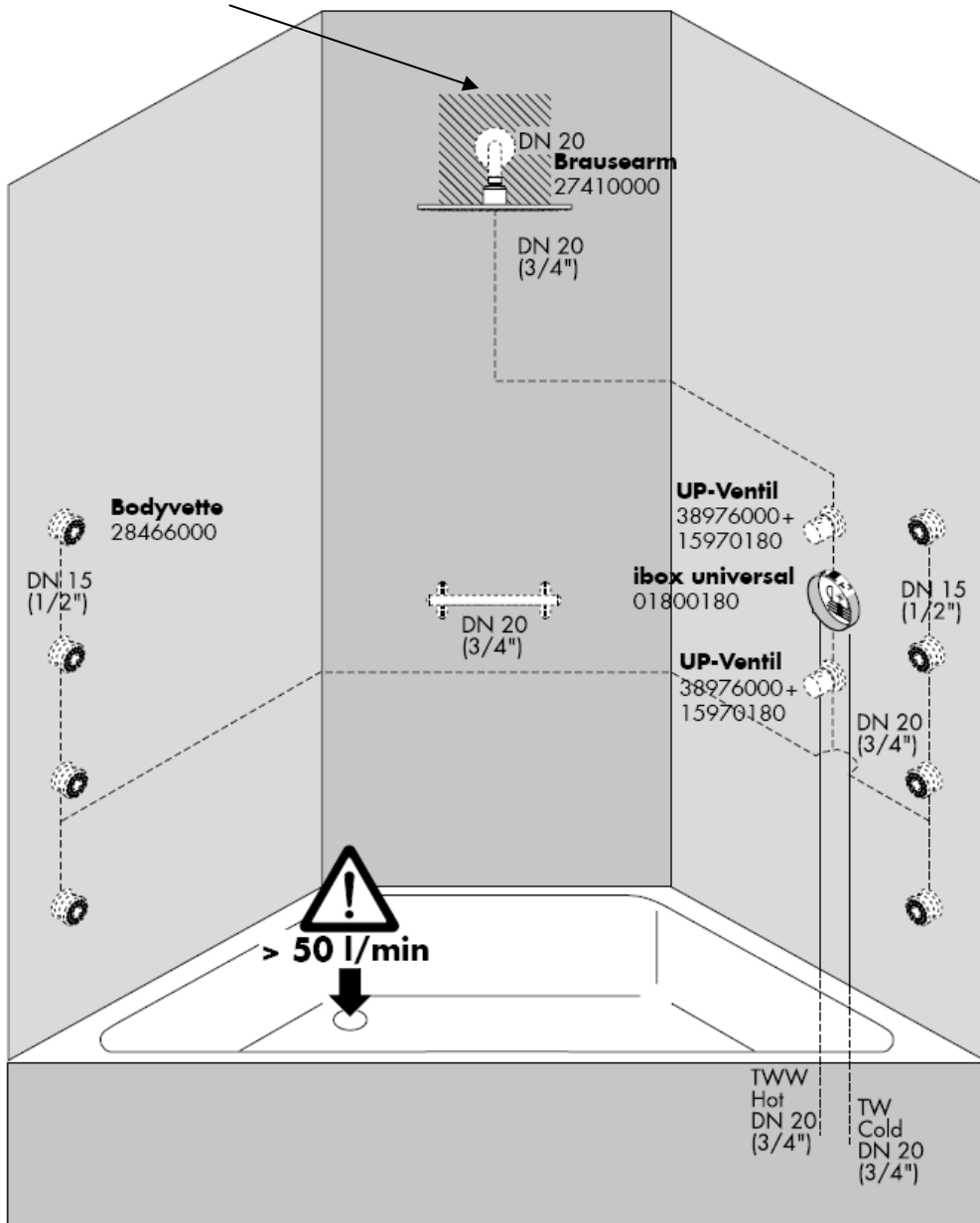

No • funkcija nodrošināta

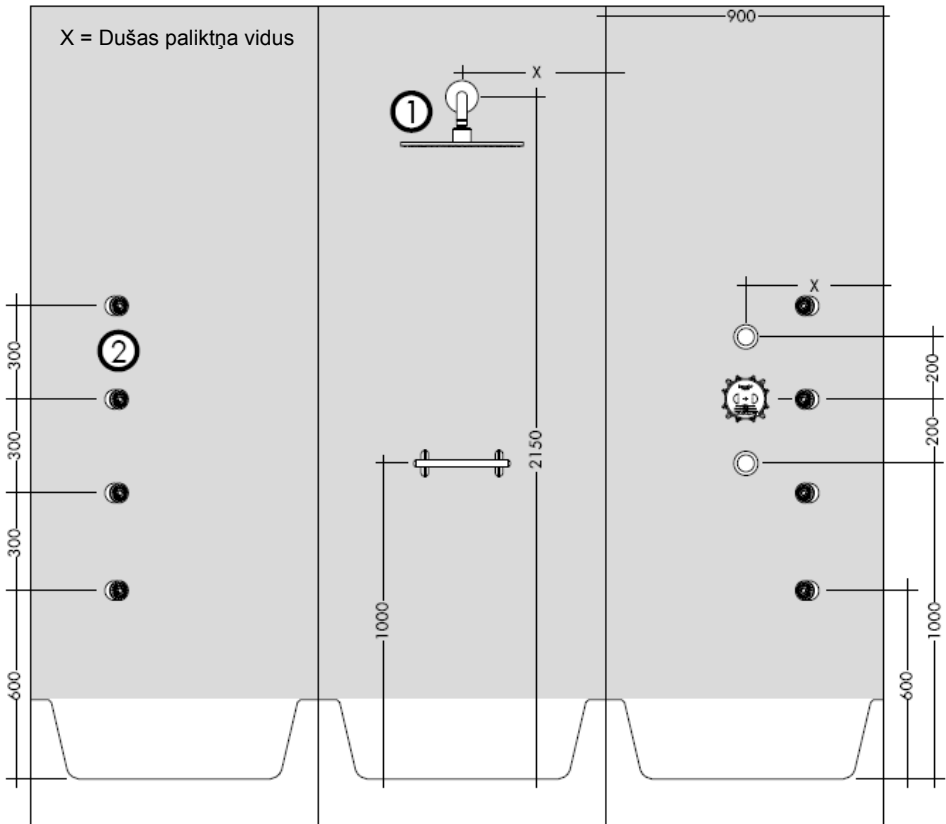
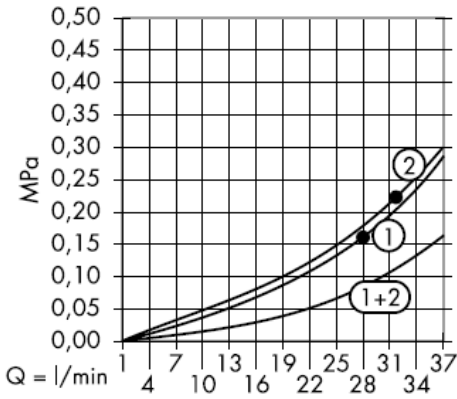

Dušas klausulei nepieciešams sienas stiprinājums

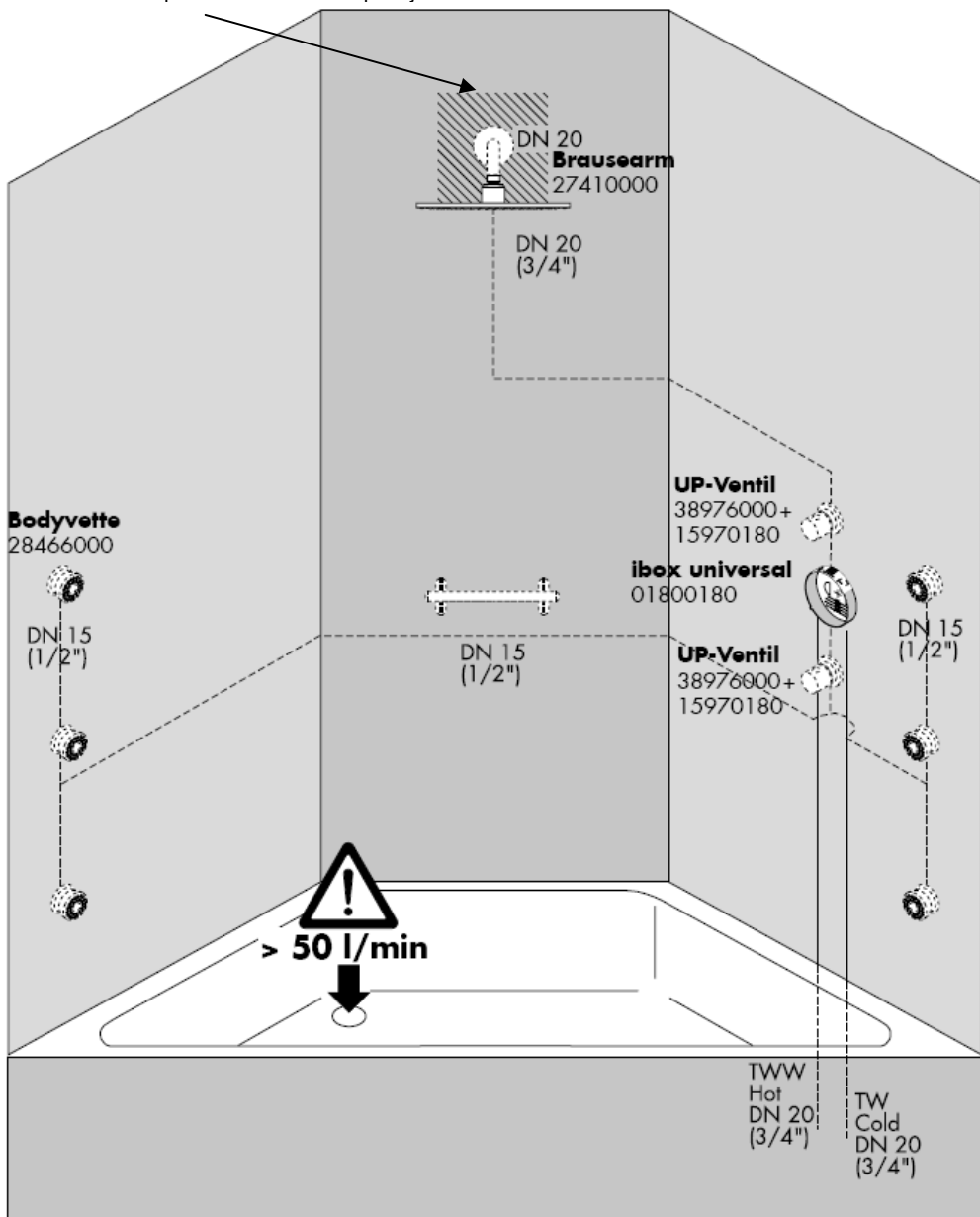

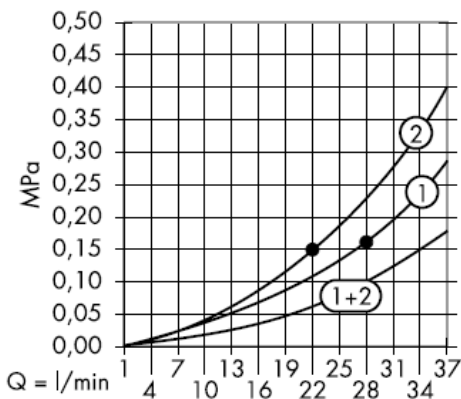

No • funkcija nodrošināta

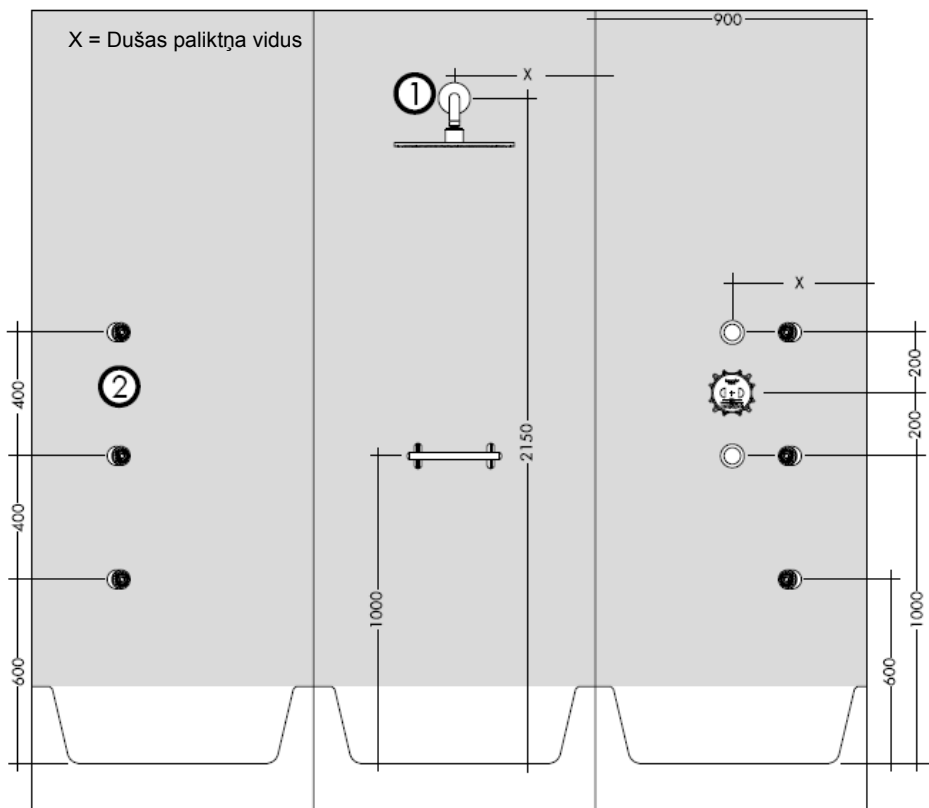

Dušas klausulei nepieciešams sienas stiprinājums

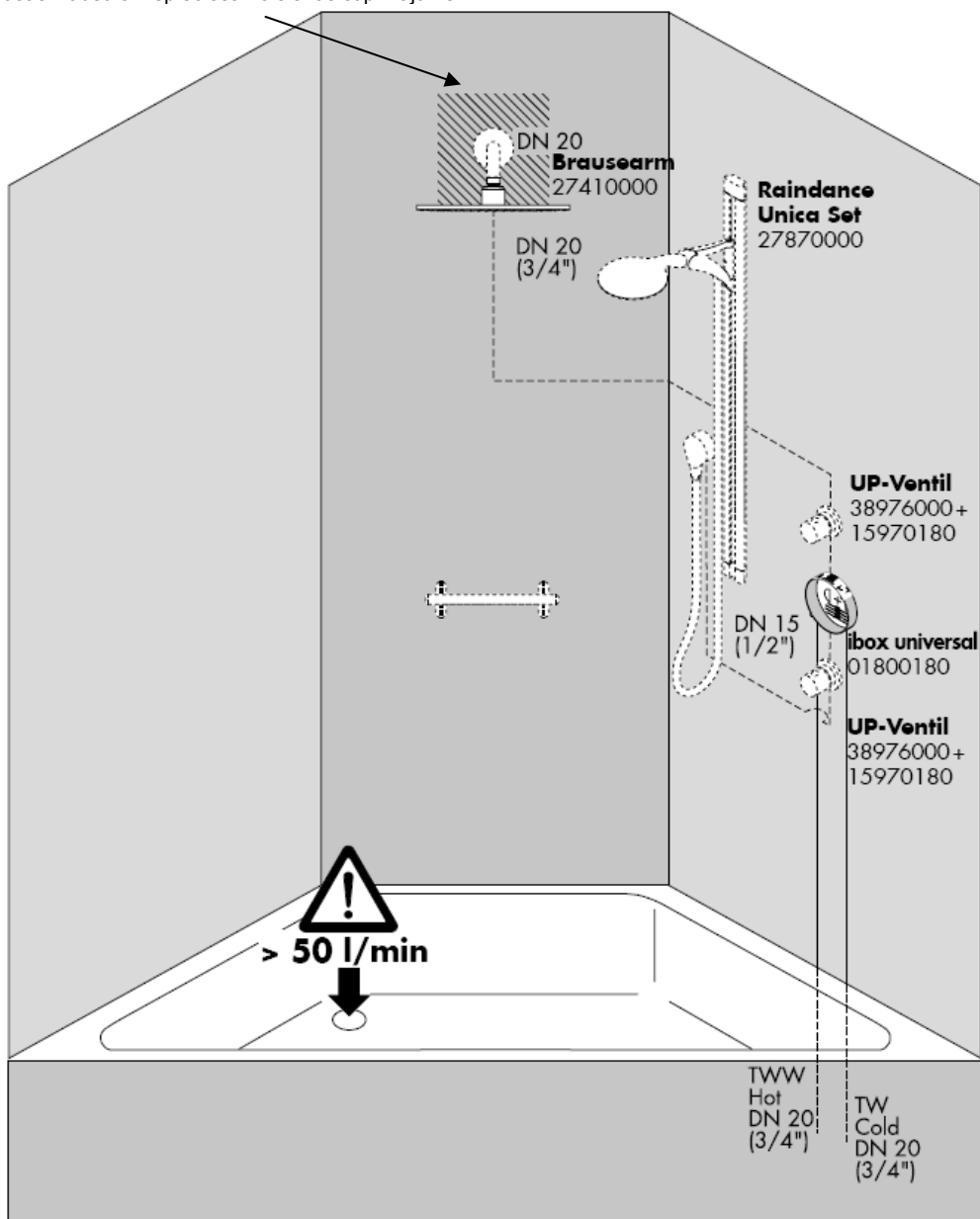

Dušas klausulei nepieciešams sienas stiprinājums

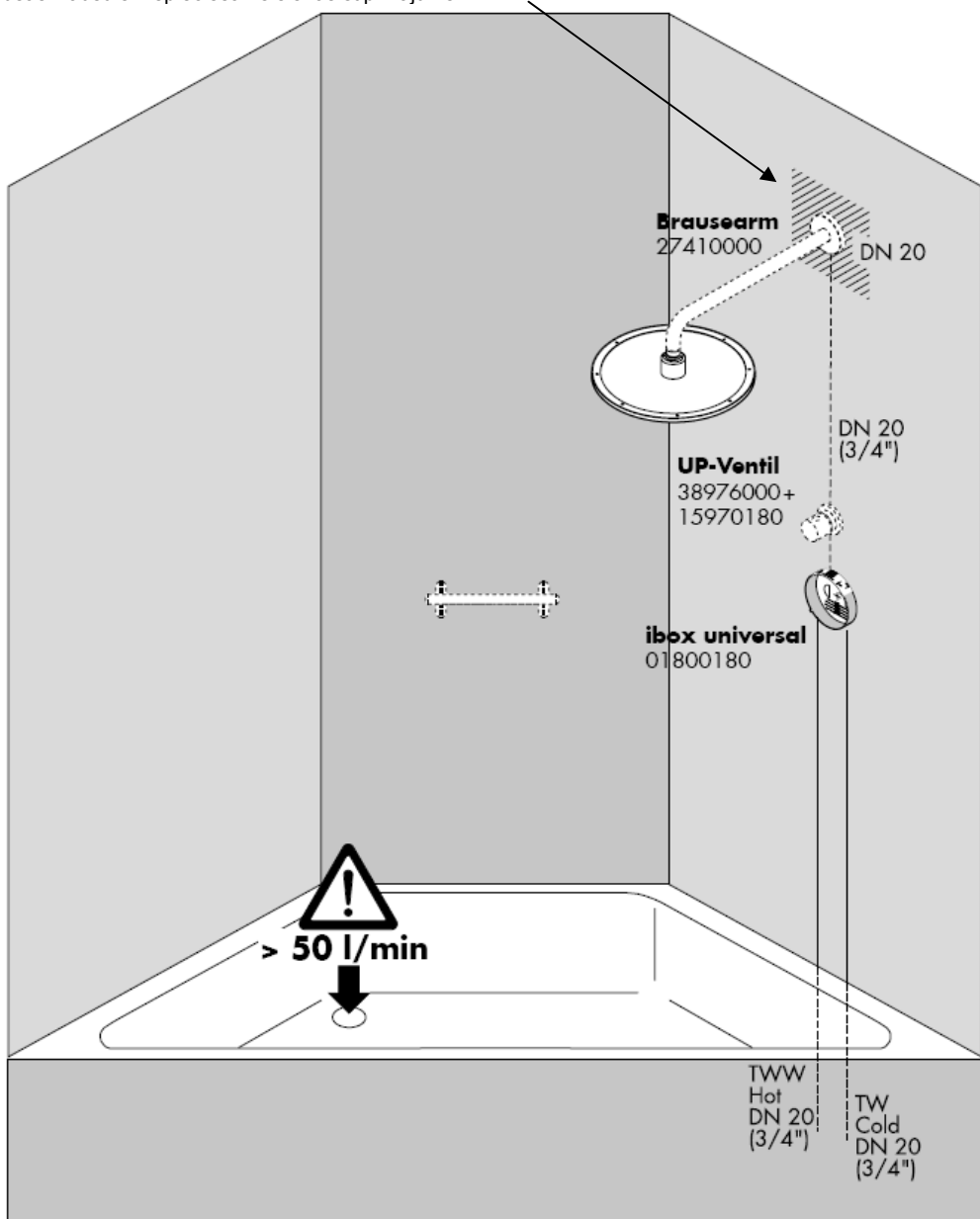

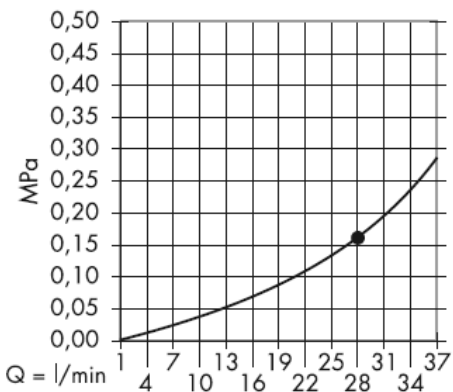

No • funkcija nodrošināta

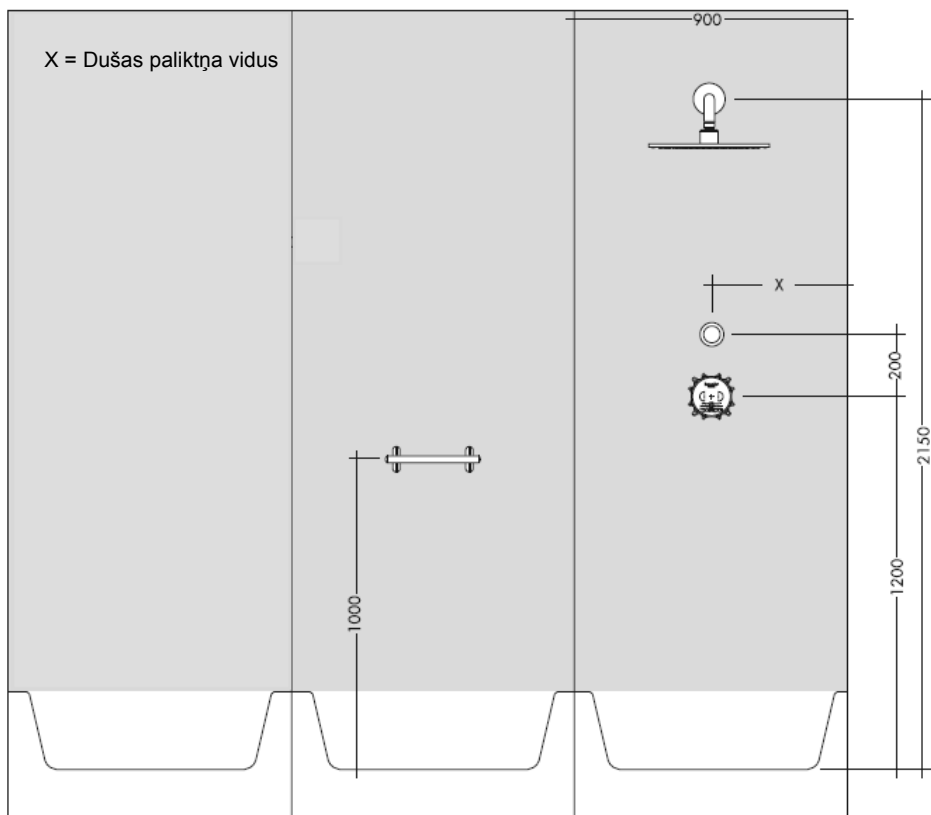

Dušas klausulei nepieciešams sienas stiprinājums

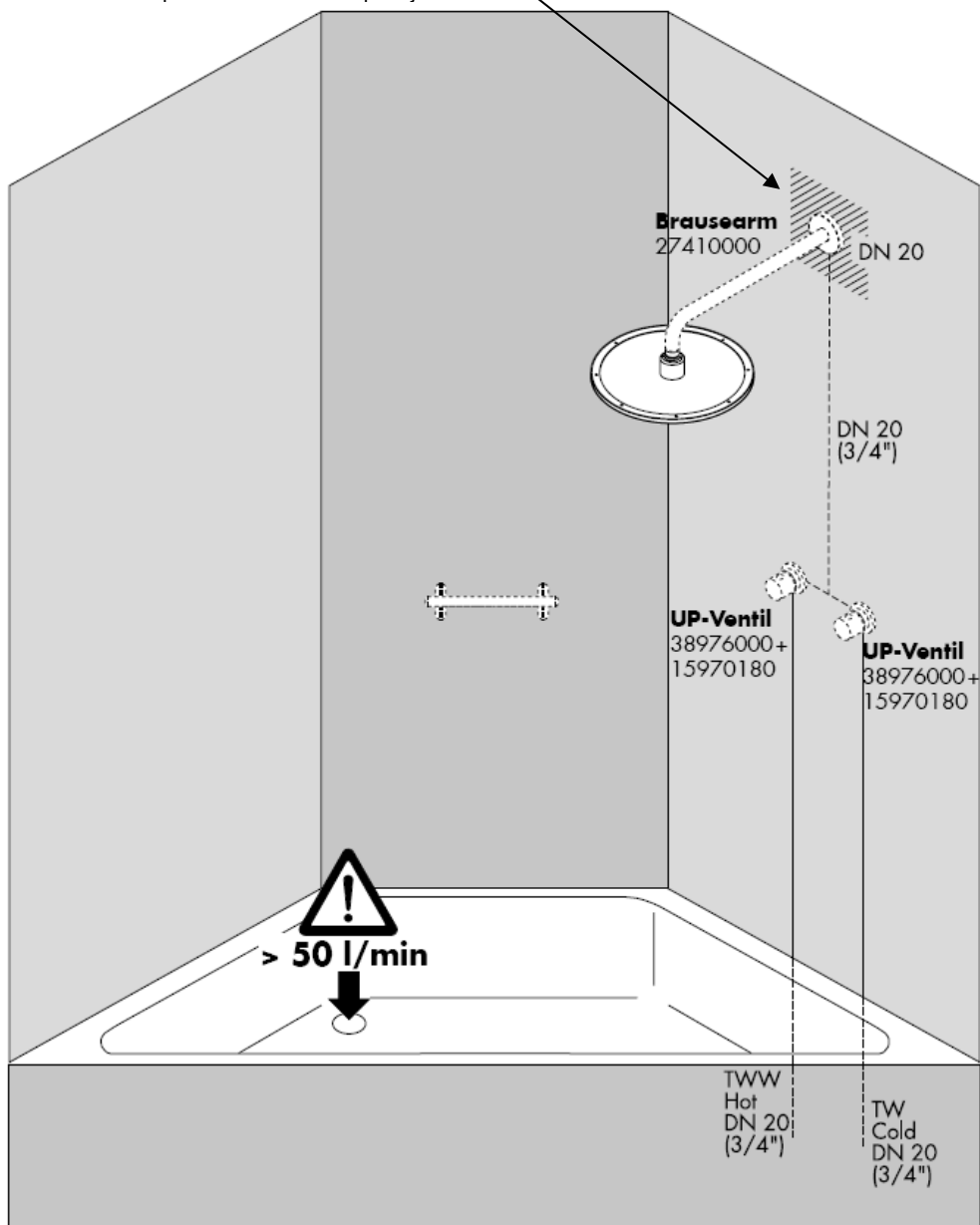

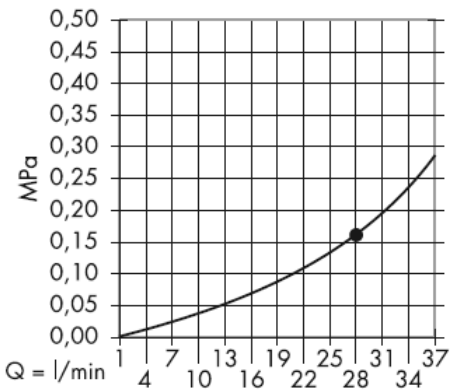

No • funkcija nodrošināta

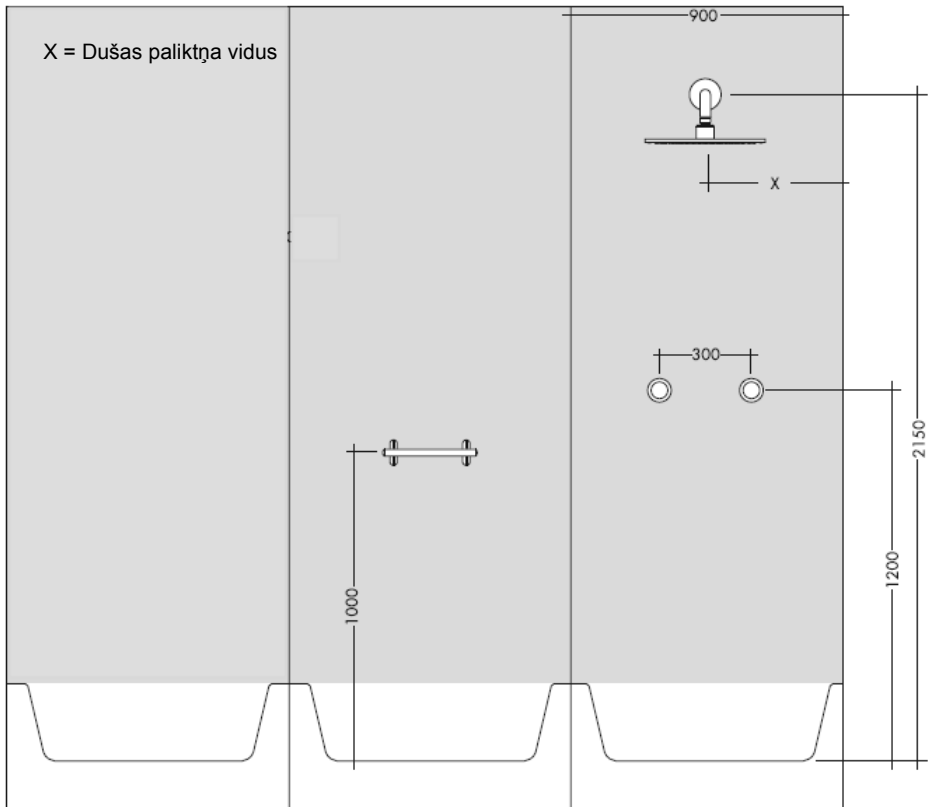

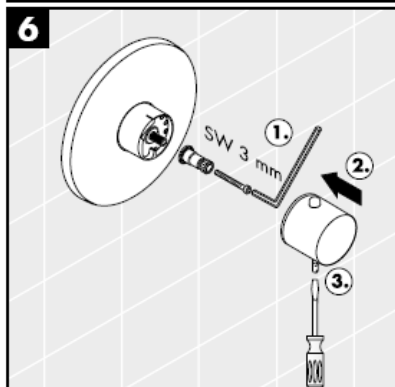
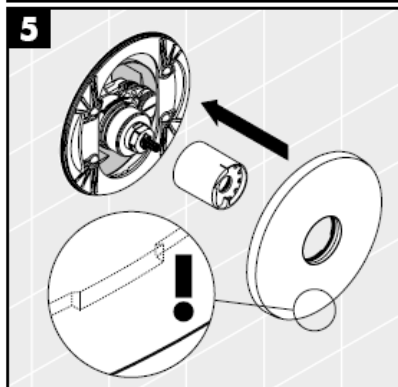
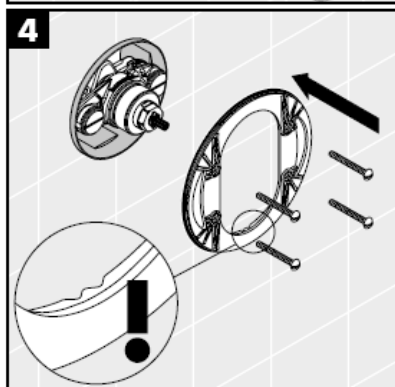
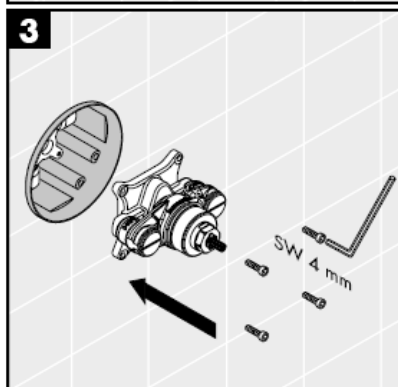
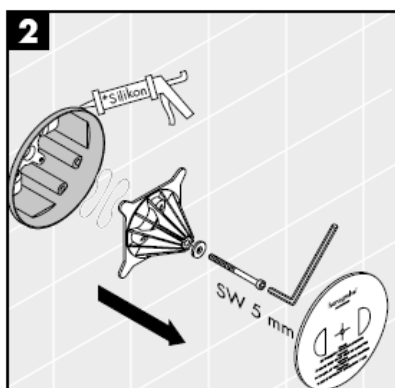
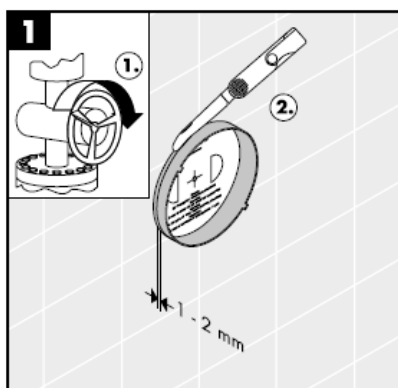

Silikon (etiškābi nesaturošs!)

Pateicoties drošības funkcijai, vēlamo augstāko temperatūru, piem., maks. 42 C, var iestatīt jau iepriekš.

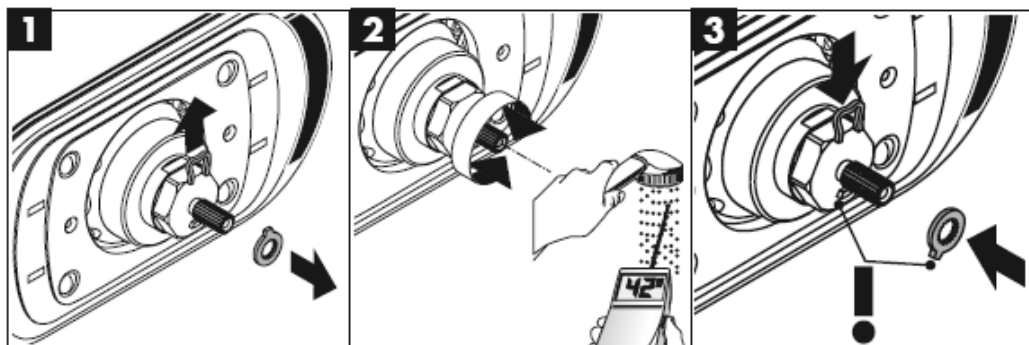

Ieregulēšana

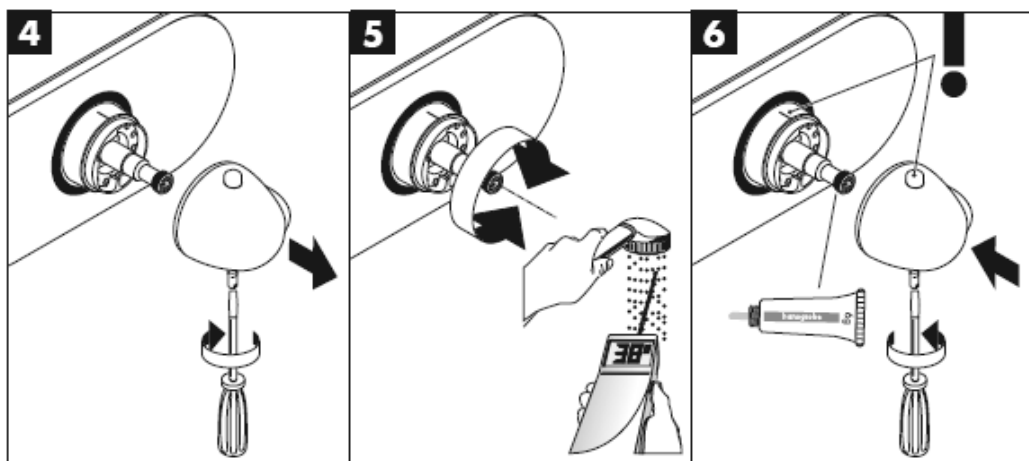



Ja duša darbojas, tad svars kopā ar dušas plecu ir apm. 10 kg. Tāpēc to drīkst izmantot tikai ar mūrniecības darbiem piemērotu nostiprināšanas materiālu! Pievienotās skrūves un aizturtaņas ir paredzētas tikai masīviem mūrniecības darbiem.

Izmantot drīkst tikai mūrim piemērotus stiprinājumus! Komplektā esošās skrūves un dībeļi ir paredzēti tikai masīvam mūrim.

Noplūdei jānodrošina pietiekama ūdens caurplūde.

Optimāla funkcija tiek garantēta tikai tad, ja tiek izmantoti Hansgrohe "High Flow" termostati.

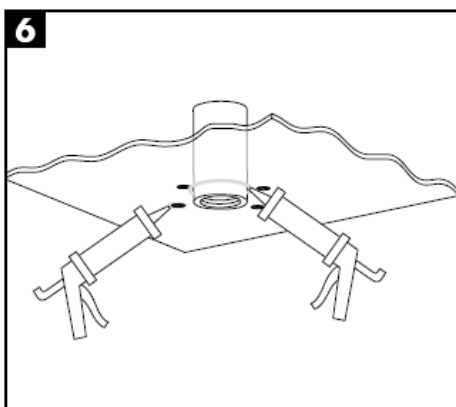
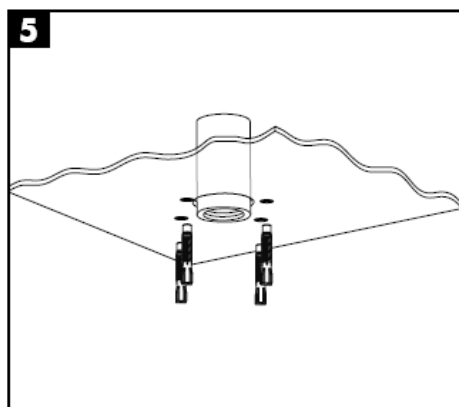
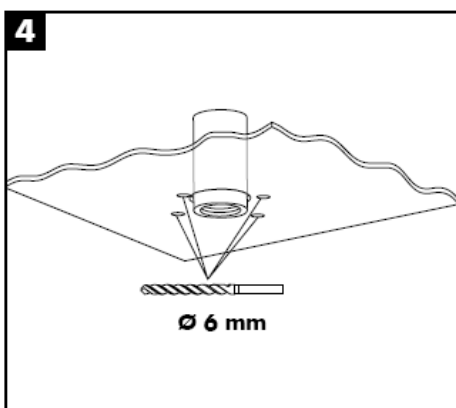
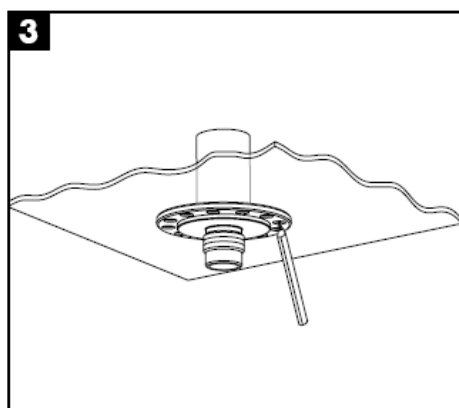
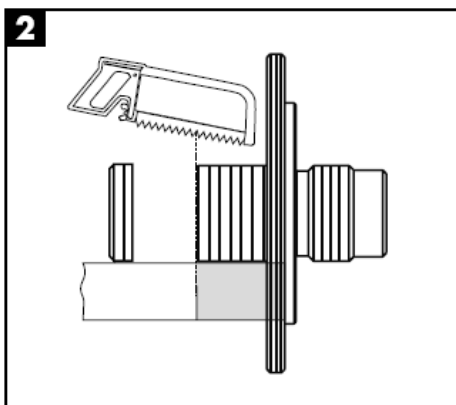
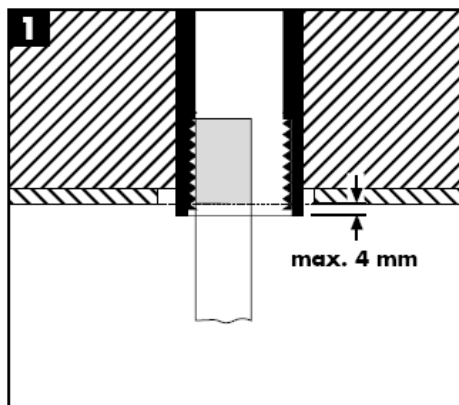

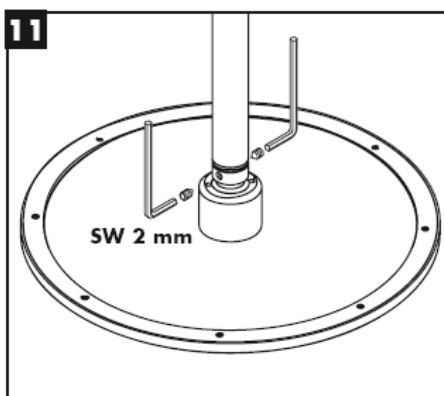
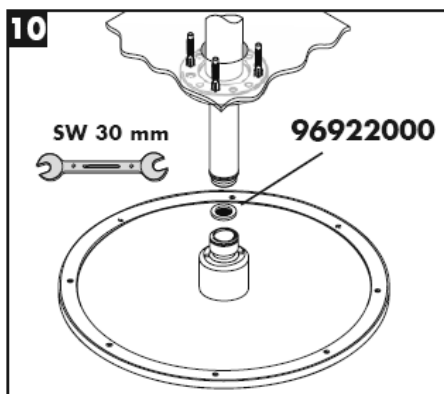
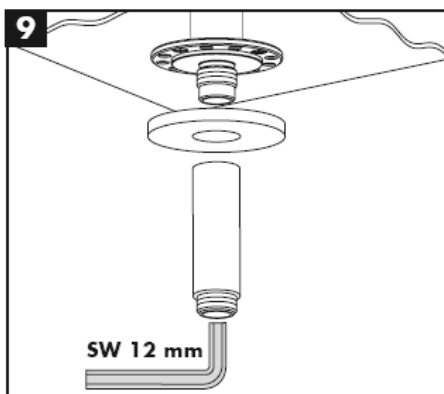
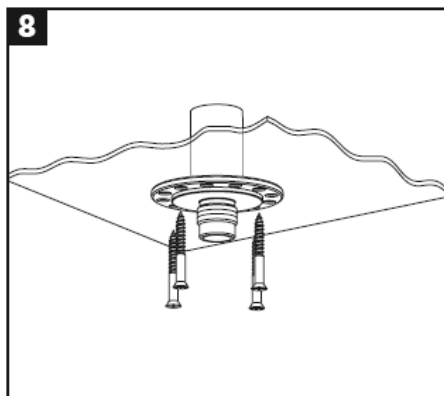
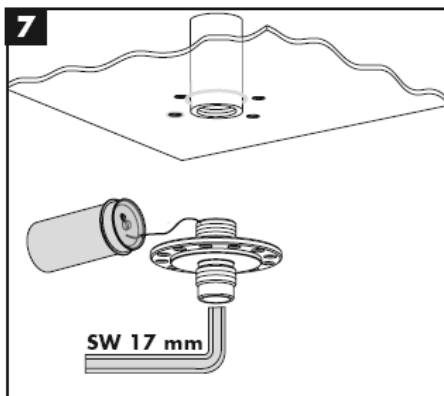

Jāiemitē dušas komplektā esošais filtrs, lai novērstu netīrumu ieplūšanu no ūdens vada. Ieskalotie netīrumi var traucēt dušas funkciju un / vai arī izraisīt rokas dušas daļu bojājumus, par kuriem Hansgrohe nenes atbildību.

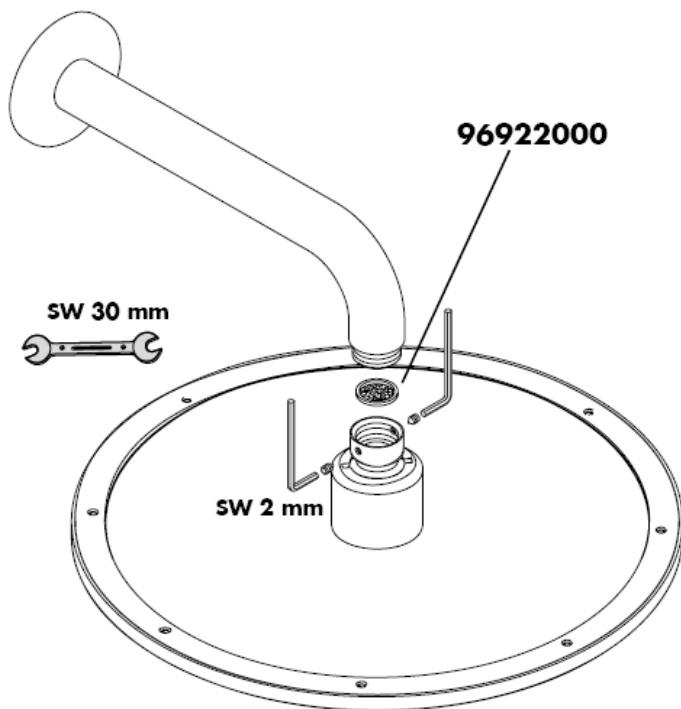

Montāža

Uzmanību! Armatūra jāuzstāda, jāizskalo un jāpārbauda atbilstoši spēkā esošajām normām!

Ieregulēšana

Korektūra ir nepieciešama gadījumā, ja ūdens temperatūra no maisītāja atšķiras no termostatā iestatītās temperatūras. Tādā gadījumā jārikojas sekojoši: rokturi ar temperatūras skalu griež tik ilgi, līdz ūdens iztecēšanas vietā ūdens sasniedzis 38 C. Atskrūvēt roktura skrūvēti, rokturi pavilkt atpakaļ un pagriezt līdz pozīcijai 38 C. Uzspraust rokturi un pievilkt skrūvi (skat. 22. lpp.).

Temperatūras ierobežošana

Speciāls drošības elements ierobežo temperatūras diapazonu līdz 38 C (aizsardzība pret apdedzināšanos). Ja ir nepieciešama augstāka temperatūra, iespiežot drošības pogu, 38 C bloķēšana tiek pārtraukta.

Drošības funkcija

Pateicoties drošības funkcijai, vēlamo augstāko temperatūru, piem., maks. 42 C, var iestatīt jau iepriekš. skat. lpp. 21.

Tehniskie dati

Darba spiediens: max. 1 MPa
 Ieteicamais darba spiediens: 0,1 – 0,5 MPa
 Pārbaudes spiediens: 1,6 MPa
 (1 MPa = 10 bar = 147 PSI)
 Karstā ūdens temperatūra: max. 80° C
 Ieteicamā karstā ūdens temperatūra: 65° C
 Caurteces intensitāte: ca. 58 l/min 0,3 MPa

Apkope

Termostatiem nav nepieciešama īpaša apkope. Regulāri jāpārbauda pretvārsta funkcija saskaņā ar DIN EN 1717 saistībā ar nacionālajiem vai vietējiem noteikumiem (DIN 1988 vienreiz gadā). Pārbaudiet arī filtrus, kas atrodas uz MTC regulatora (6.1). Pēc MTC regulatora (6) montāžas obligāti jāpārbauda ūdens temperatūra pēc principa, kas aprakstīts punktā "Ieregulēšana". Pirms tam obligāti pārbaudiet, vai ir pieslēgta karstā ūdens padeve un vai ūdens padeves vietā ir maksimāla karstā ūdens temperatūra.

Lai nodrošinātu regulatora nevainojamu darbību, termostatu laiku pa laikam jāiestata uz maksimāli aukstu un maksimāli karstu ūdeni.

Rezerves daļas skat. lpp. 3

1	Termostata rokturis	38391000
2	Rozete	96452000
3	uzmava	97439000
4	Fiksācijas skrūves	96454000
5	Balsta plāksne	96447000
6	Temperatūras regulators	96633000
7	Filtrs	97367000
8	Pretvārsts	96655000
9	Pagarinājums 25 mm	13595000
10	Pagarinājums 25 mm	13596000

Latviski

Traucējums	Iemesls	Bojājumu novēršana
Maz ūdens	-Problēmas ar ūdens apgādi -Netīrs regulatora filtrs -Netīrs dušas filtra blīvējums	-Pārbaudīt spiedienu ūdenvadā -Tīrīt filtrus -Iztīrīt filtra blīvējumu starp dušu un šļūteni
Ūdens sajaukšanās, karstais ūdens slēgtā stāvoklī tiek spiests aukstā ūdens cauruļvados un otrādi.	-Pretvārsts ir netīrs / bojāts	-Nomainīt pretvārstu
Ūdens temperatūra nesaskan ar iestatīto temperatūru	-Termostats nav pieregulēts -Pārāk zema ūdens temperatūra	-Pieregulēt termostatu -Paaugstināt karstā ūdens temperatūru no 42 C līdz 65 C
Nav iespējama temperatūras regulēšana	-Termoregulators ir aizkaļķojies vai netīrs -Pagrieziet par 180 iekšējo bloku	-Jaunas instalācijas gadījumā pamatelements ir nepareizi pieslēgts (jābūt: aukstais ūdens pa labi, karstais pa kreisi) vai ir pārgriezts par 180 . -Nestrādā sarkanā poga, kas pasargā pret apdedzināšanos
Bojāta atspere	-Iztīrīt un ieeļļot, ja nepieciešams, nomainīt atsperi vai pogu -Poga ir aizkaļķojusies	-Iztīrīt un ieeļļot, ja nepieciešams, nomainīt atsperi vai pogu -Iztīrīt un ieeļļot, ja nepieciešams, nomainīt atsperi vai pogu

Pārbaudes zīme

	P-IX	DVGW	SVGW	WRSA	KIWA	ACS	NF
27070000						X	
27418XXX							
28420000						X	
28435XXX						X	

Tīrīšana

Vienkārša tīrīšana: kalķis no izvirzījumiem ir viegli norubināms.

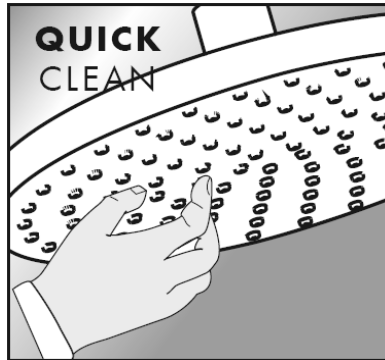

Kopšanas instrukcija

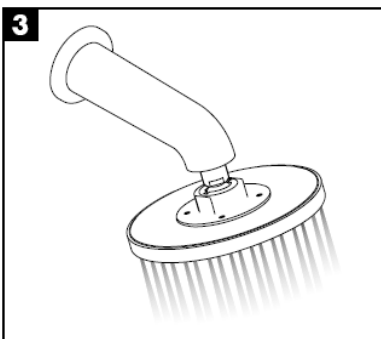
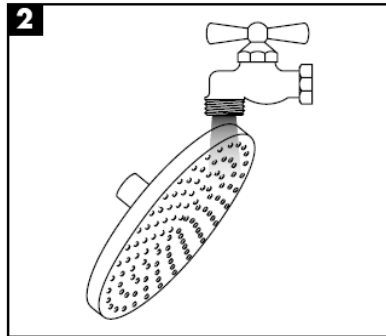
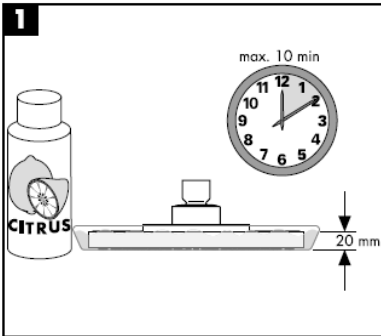

hansgrohe

Uputstvo za montažu



27418XXX

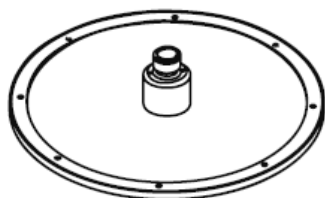

Raindance Royale AIR
28420000

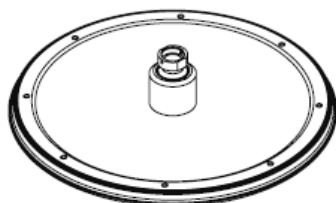

Raindance Royale Classic AIR
28435XXX

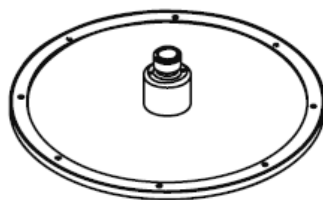

**Raindance Royale
High Flow Set**
27070000

hangrohe

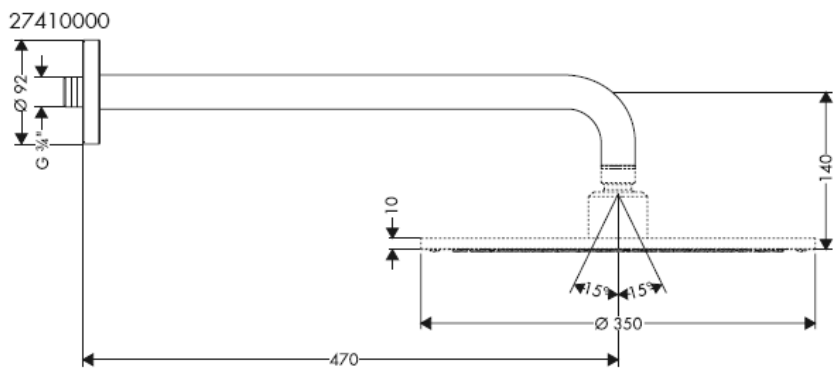
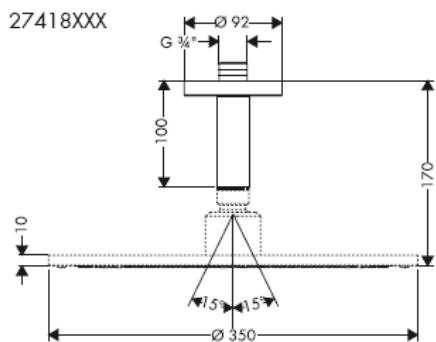
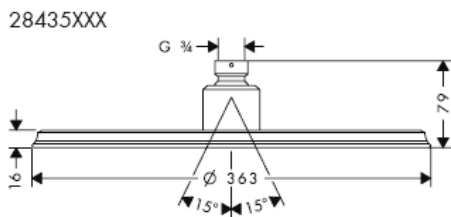
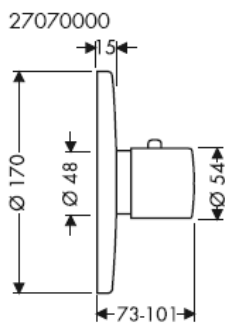
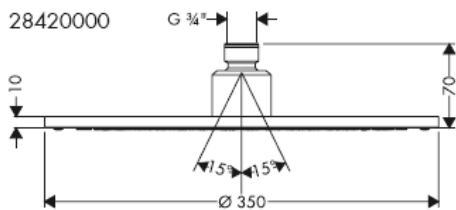

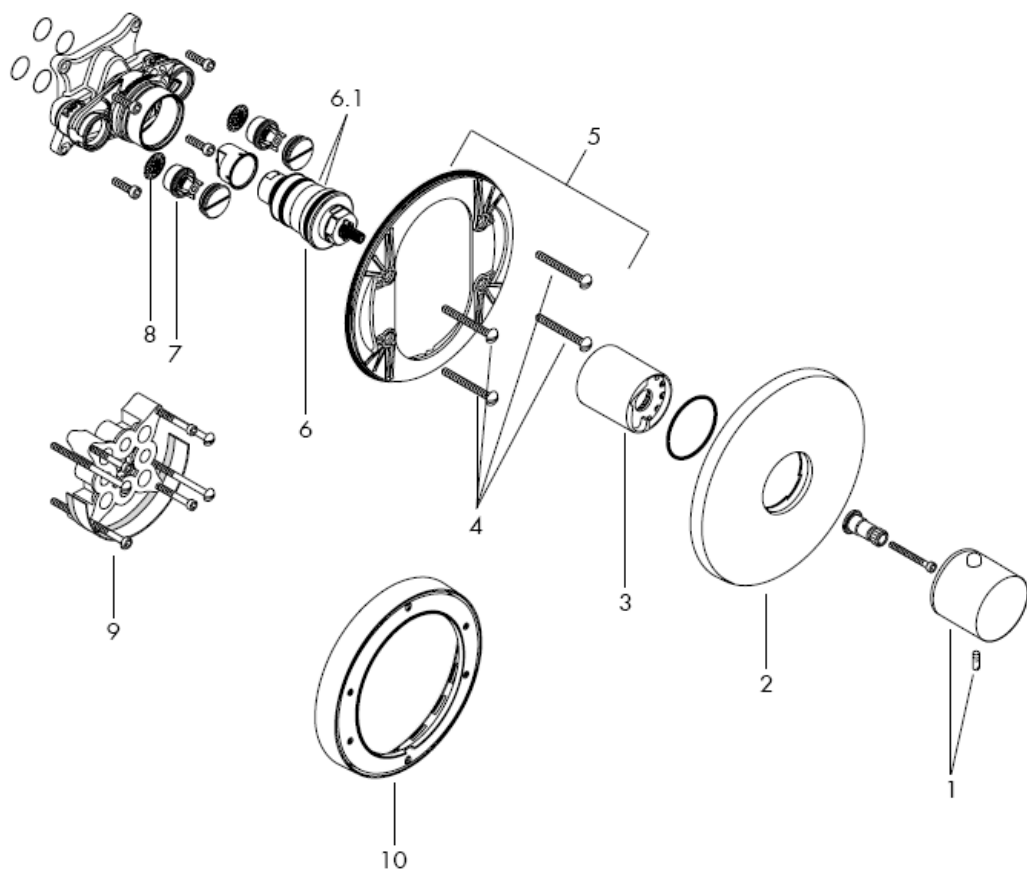

Prilagodite meru što je više moguće rasteru pločica.

Neophodno ojačanje zida za pričvršćenje ruke tuša

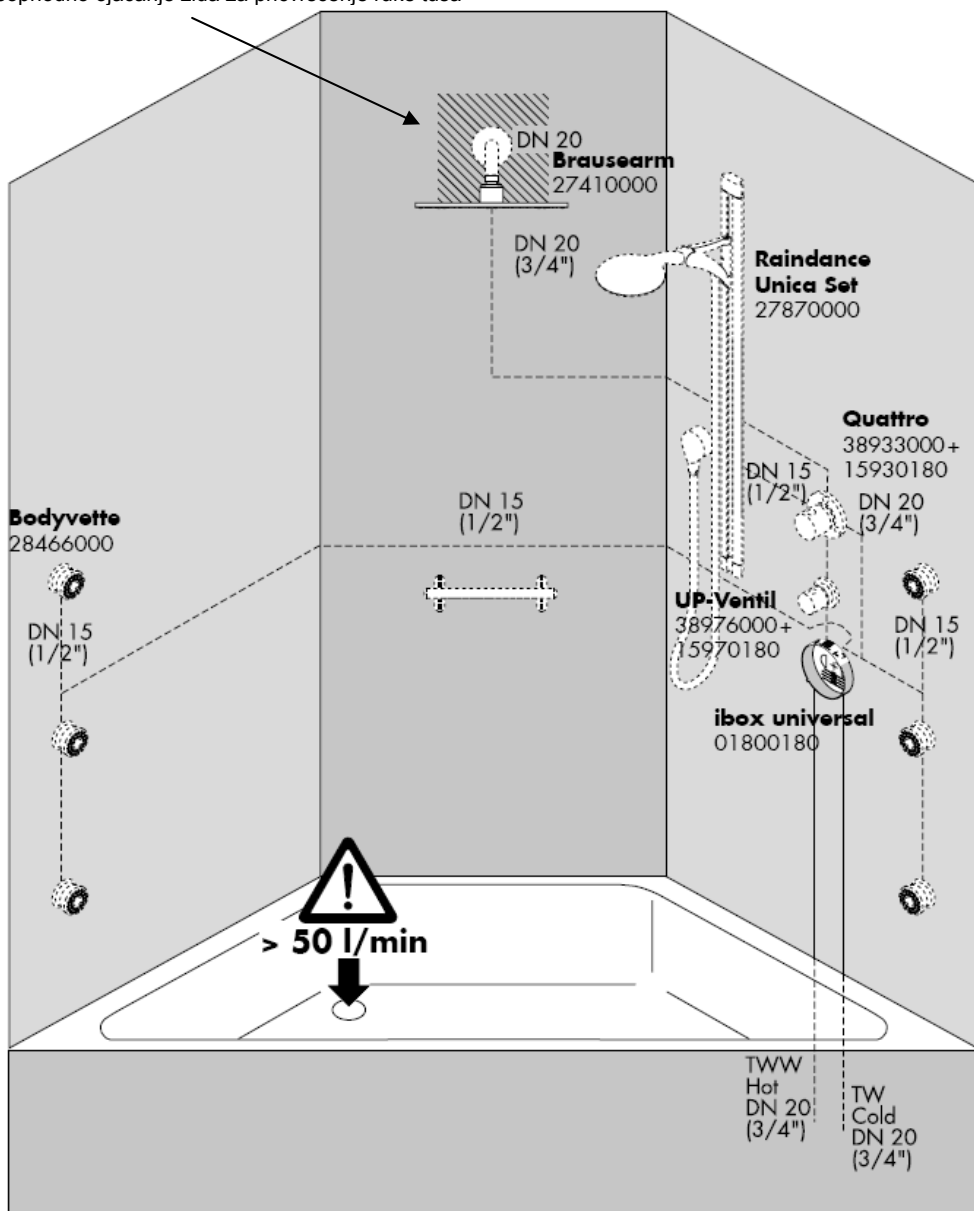

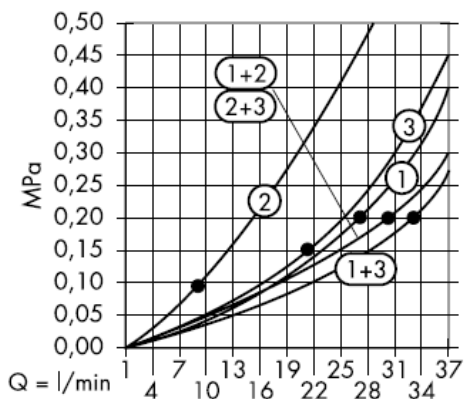

Od • je funkcija zagantovana.

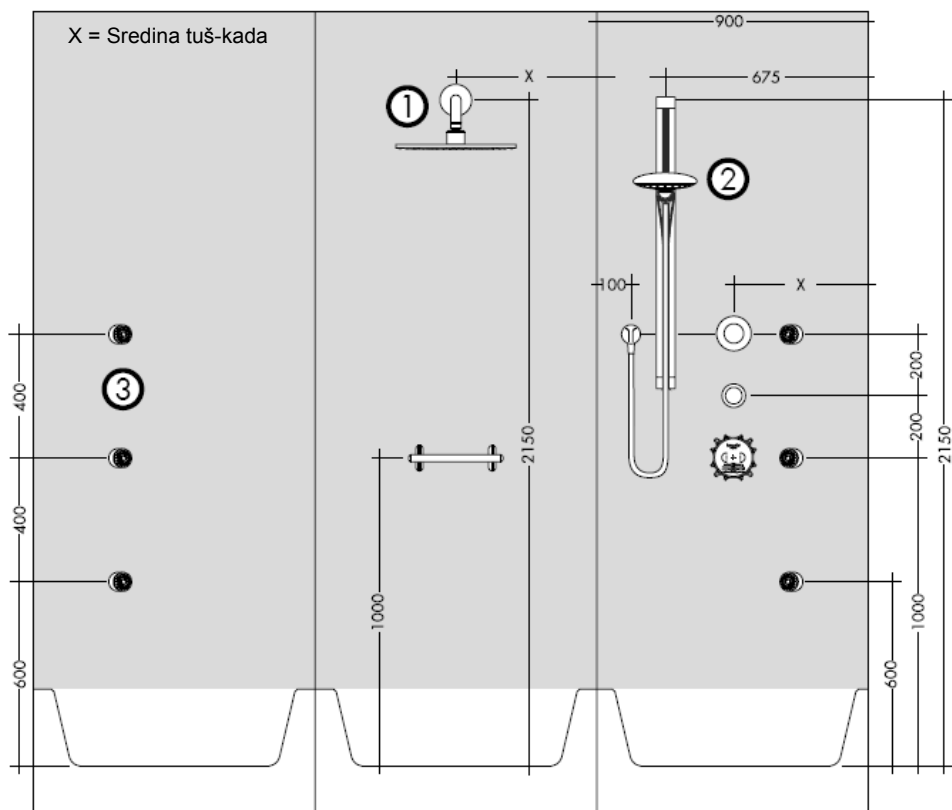

Neophodno ojačanje zida za pričvršćenje ruke tuša

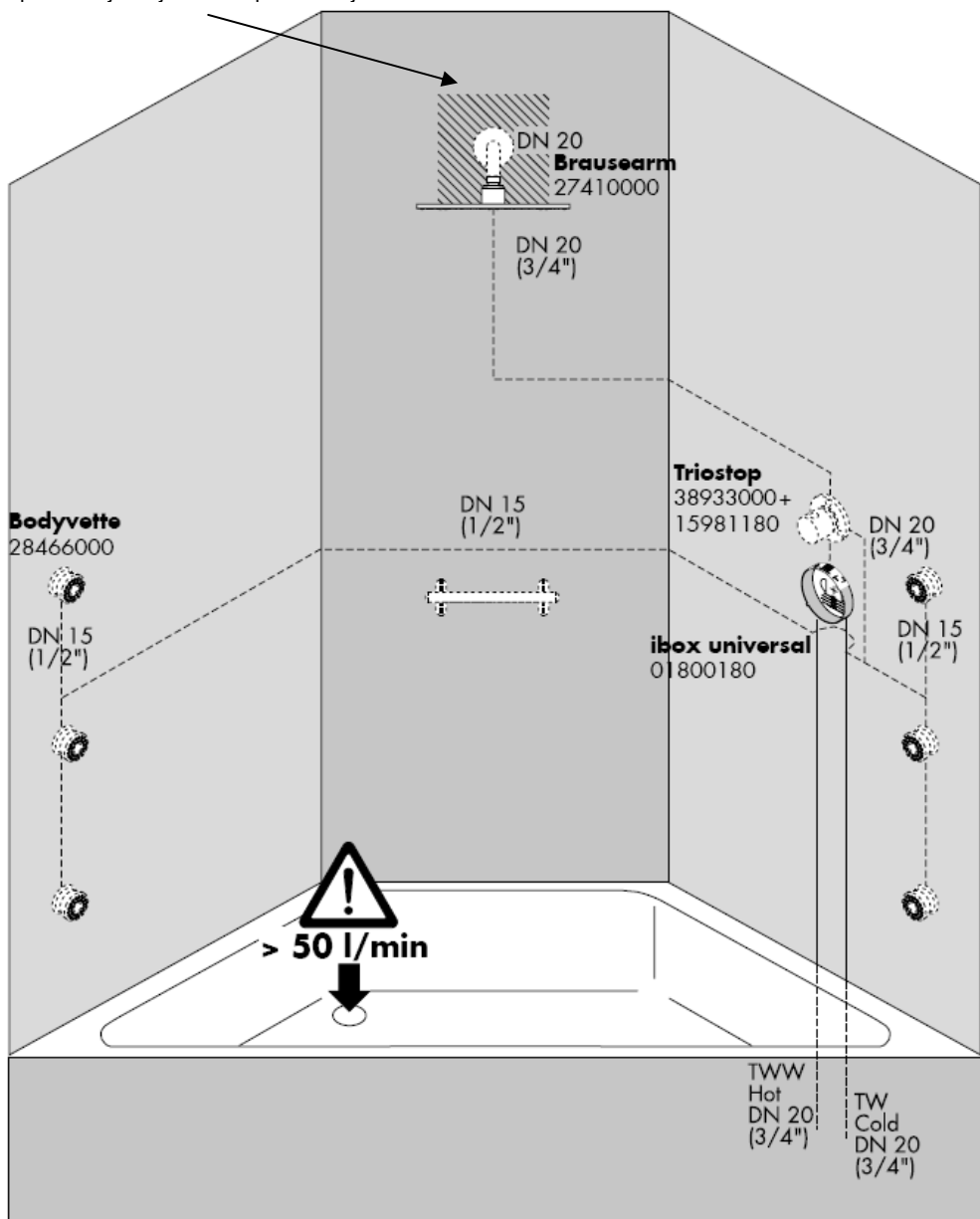

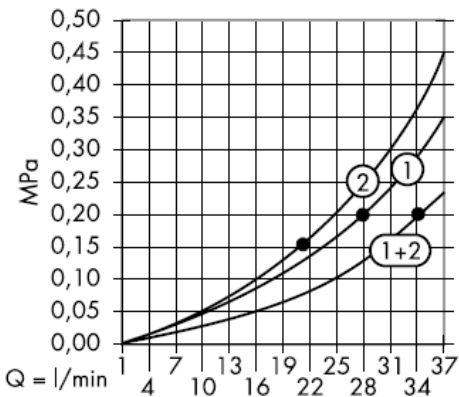

Od • je funkcija zagotovljena.

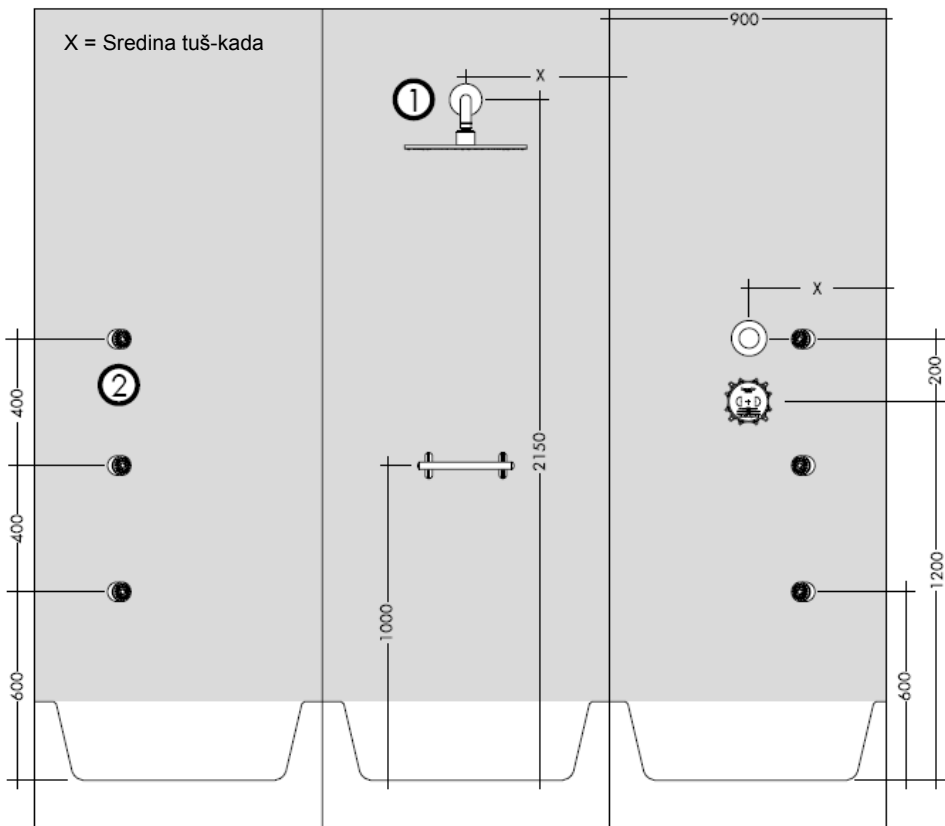

Neophodno ojačanje zida za pričvršćenje ruke tuša

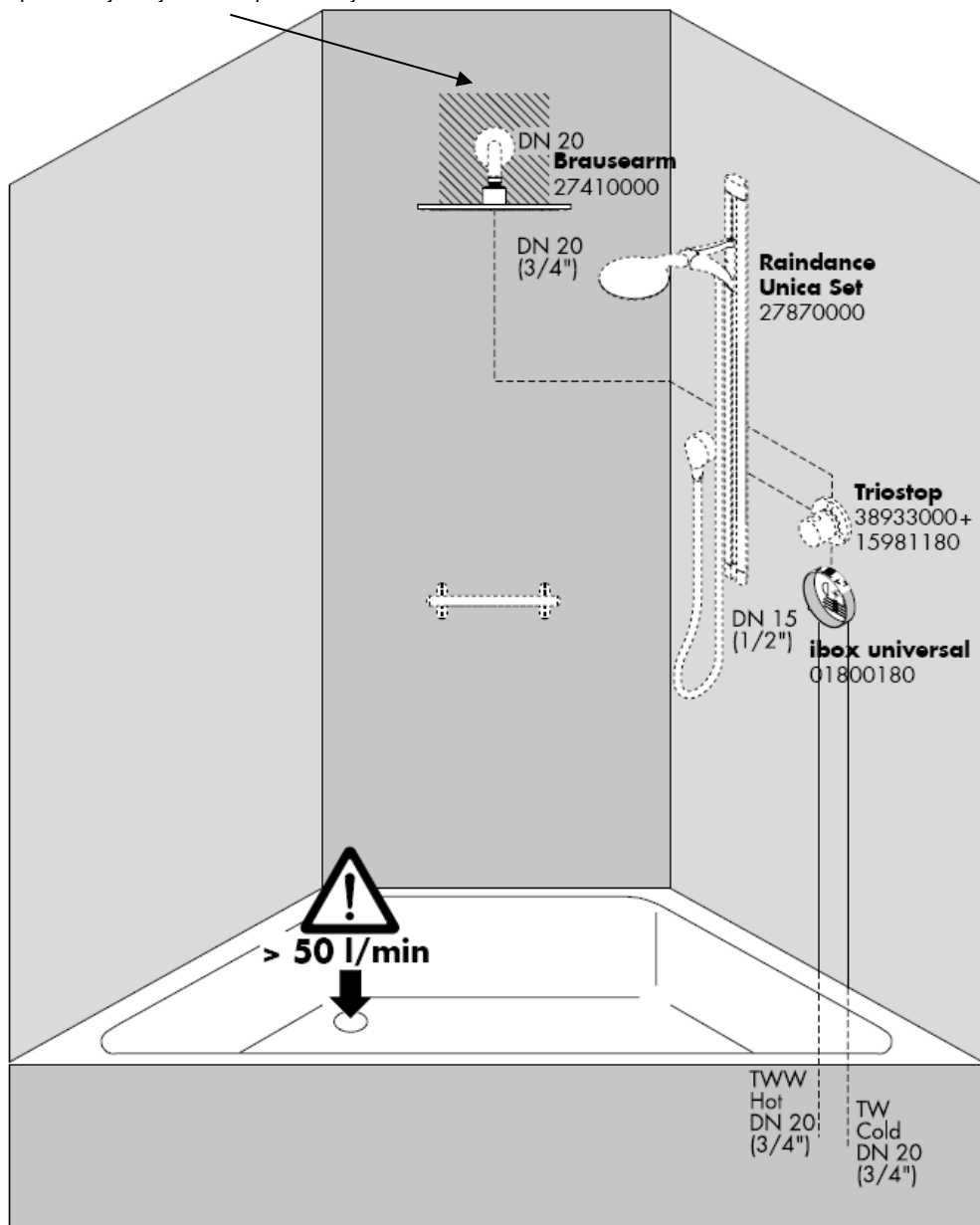

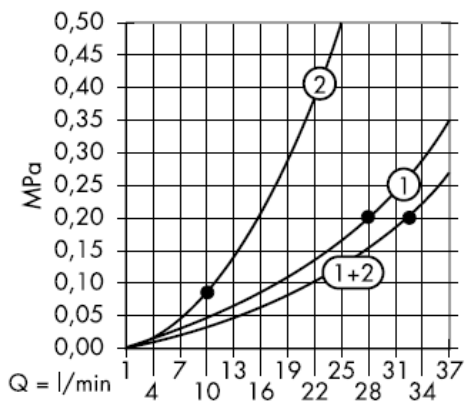

Od • je funkcija zagantovana.

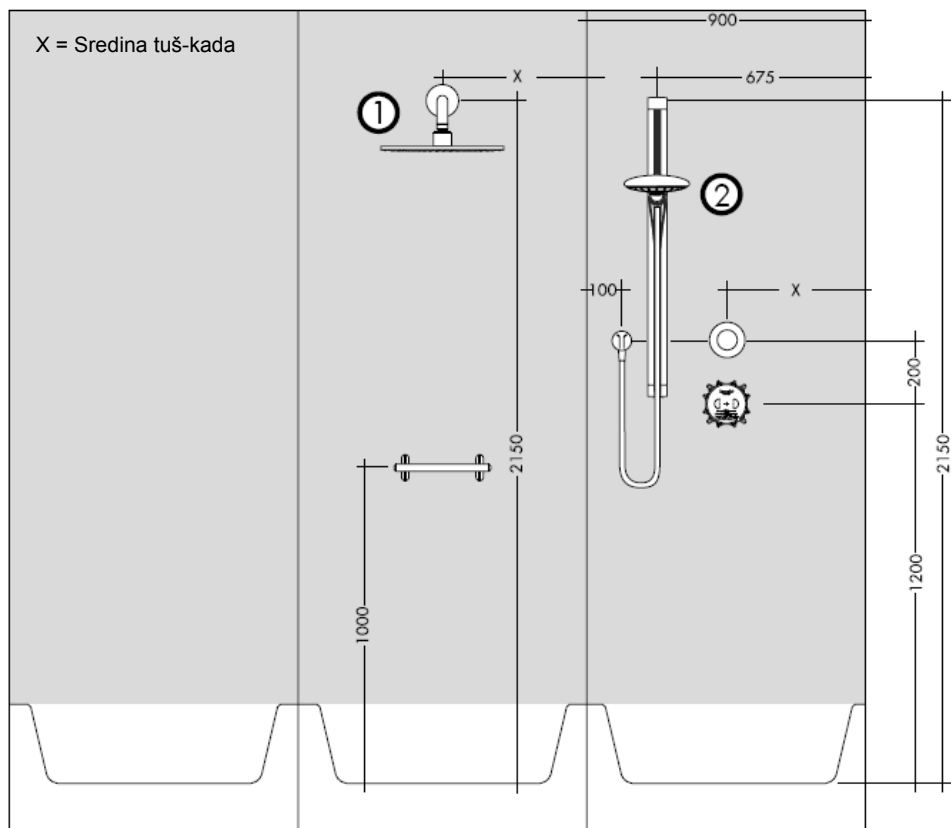

Neophodno ojačanje zida za pričvršćenje ruke tuša

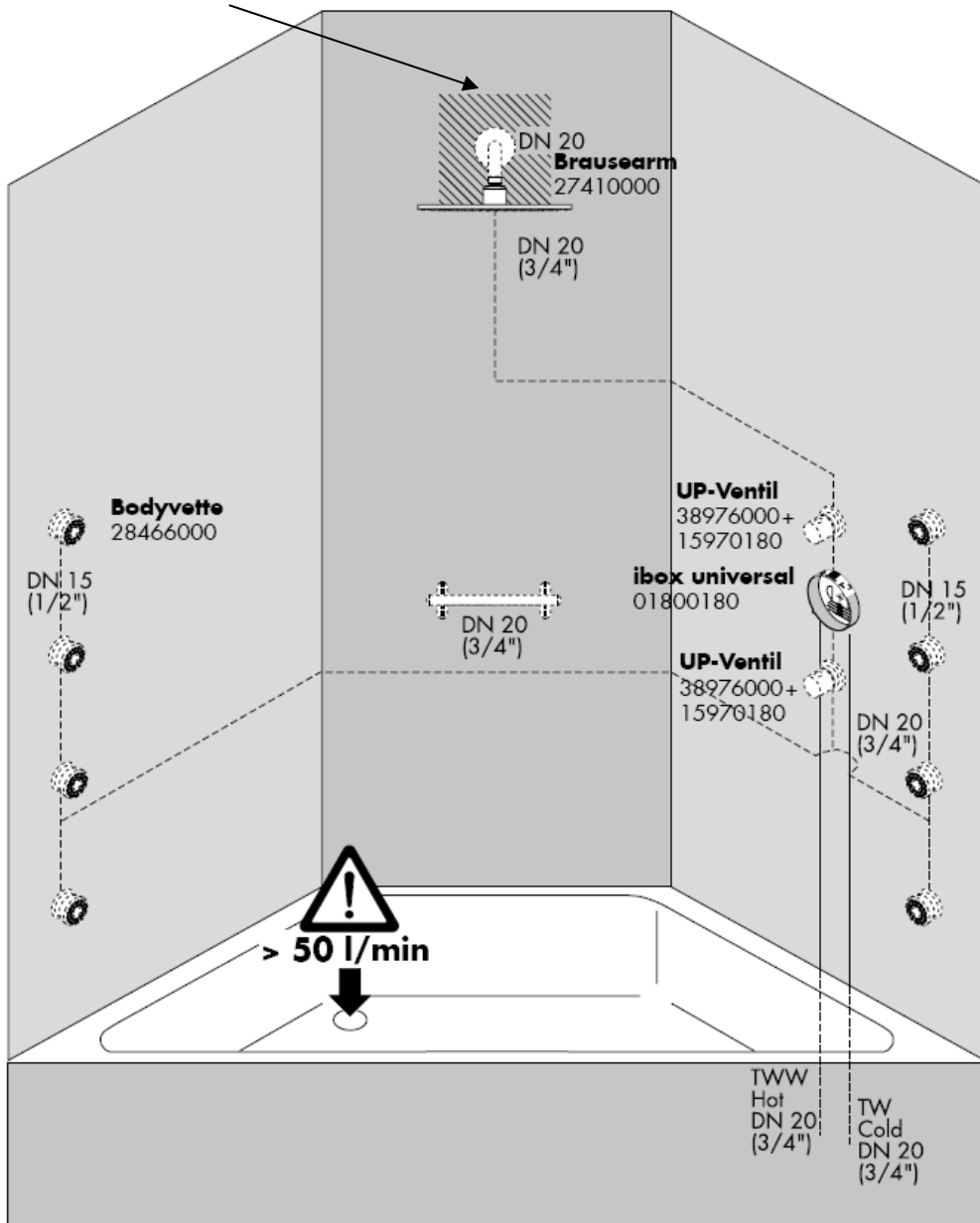

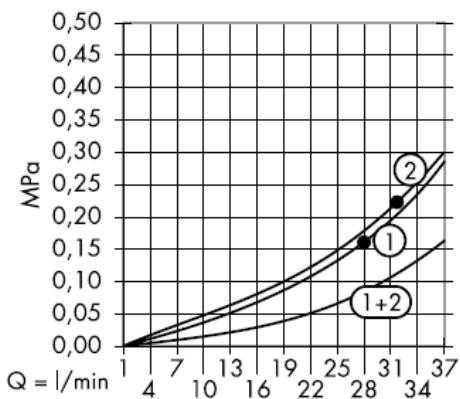

Od • je funkcija zagarantovana.

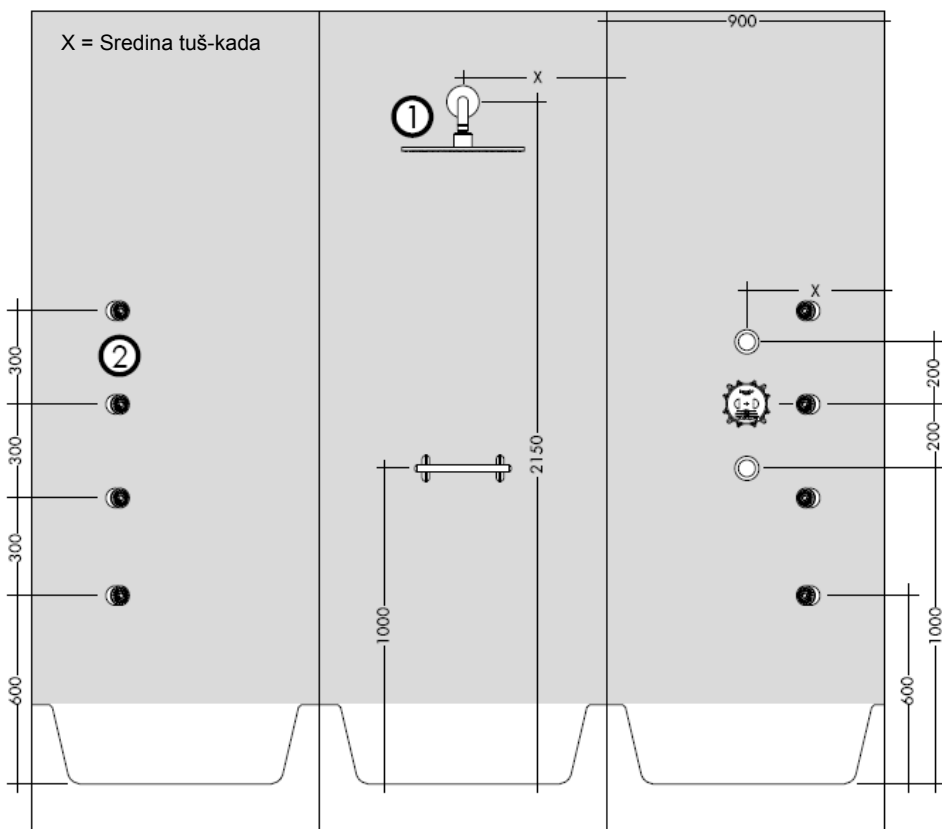

Neophodno ojačanje zida za pričvršćenje ruke tuša

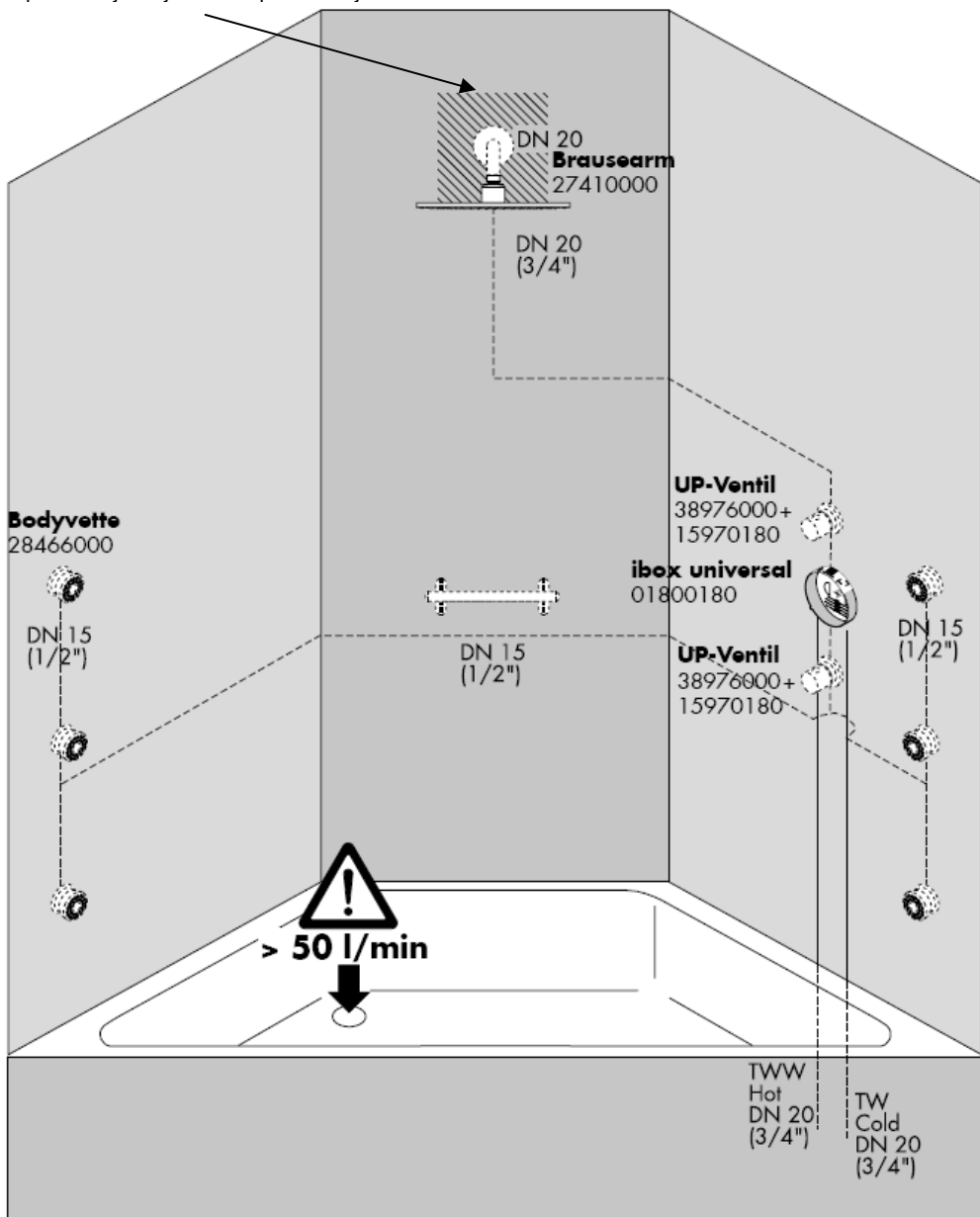

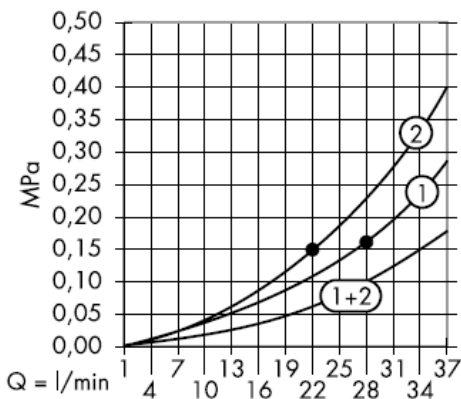

Od • je funkcija zagantovana.

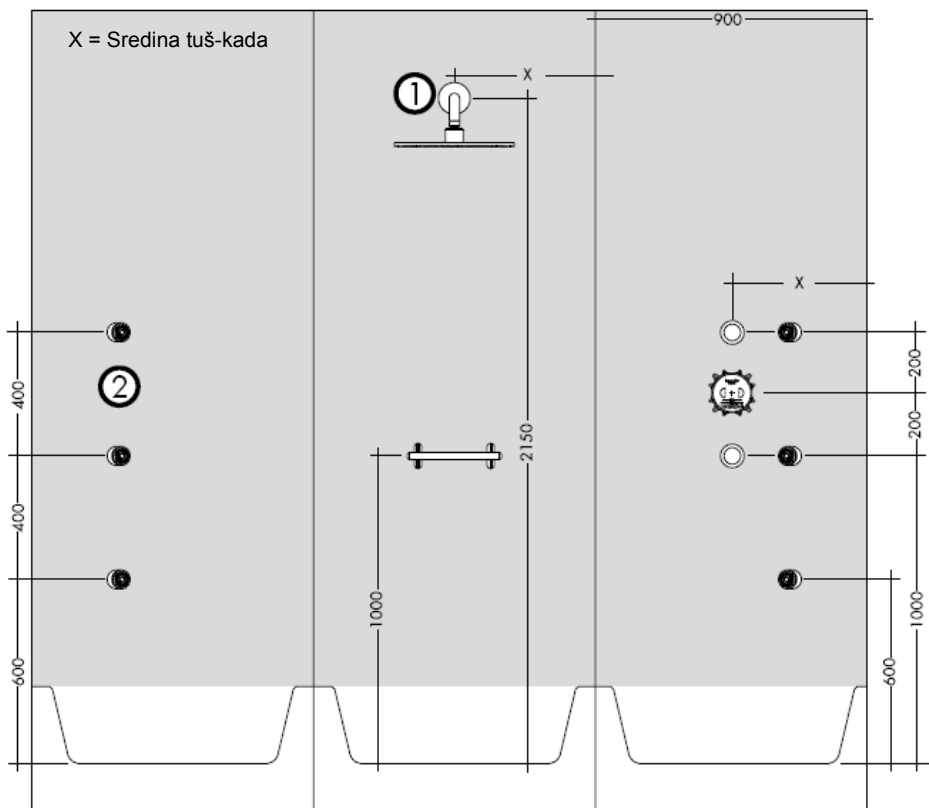

Neophodno ojačanje zida za pričvršćenje ruke tuša

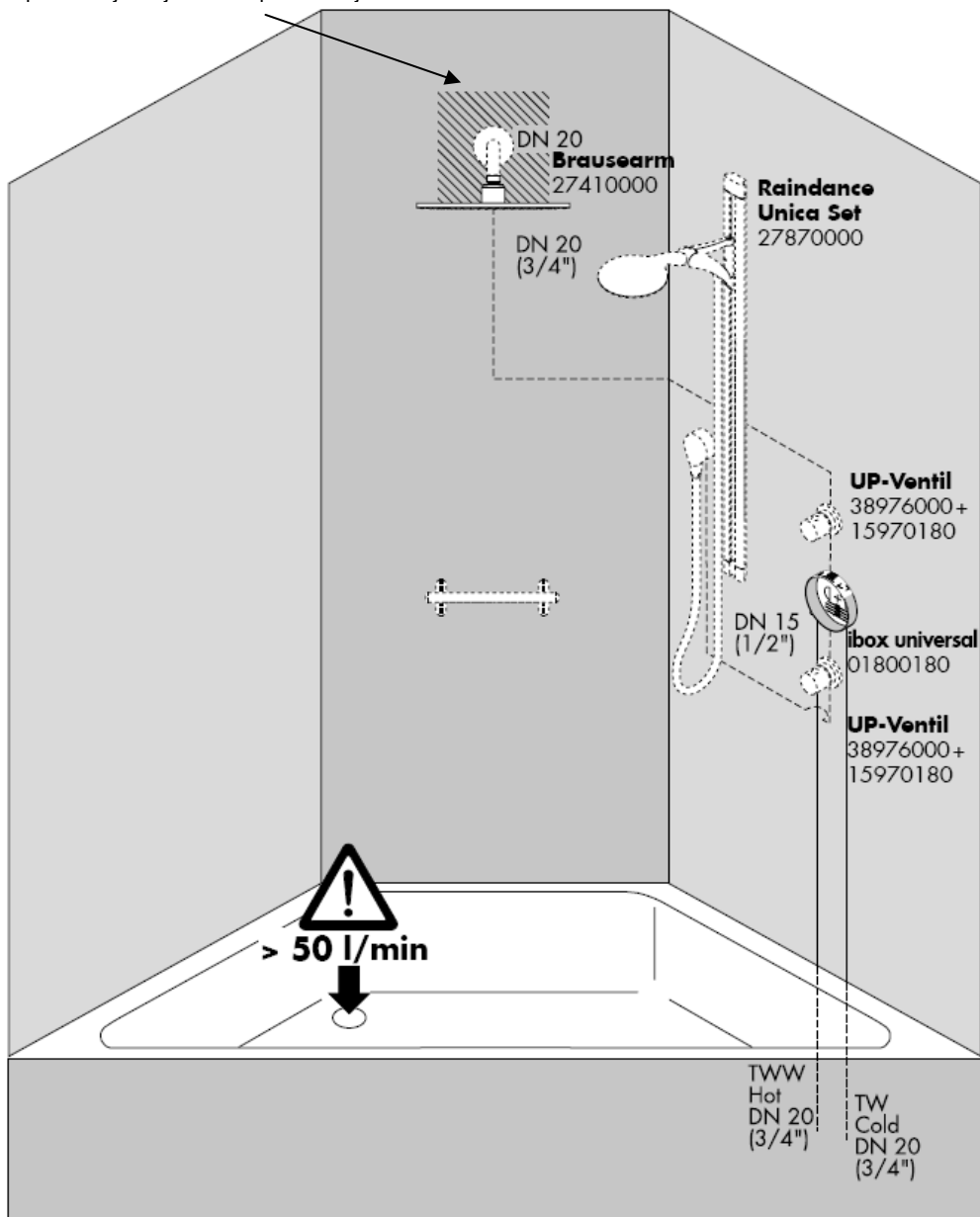

Neophodno ojačanje zida za pričvršćenje ruke tuša

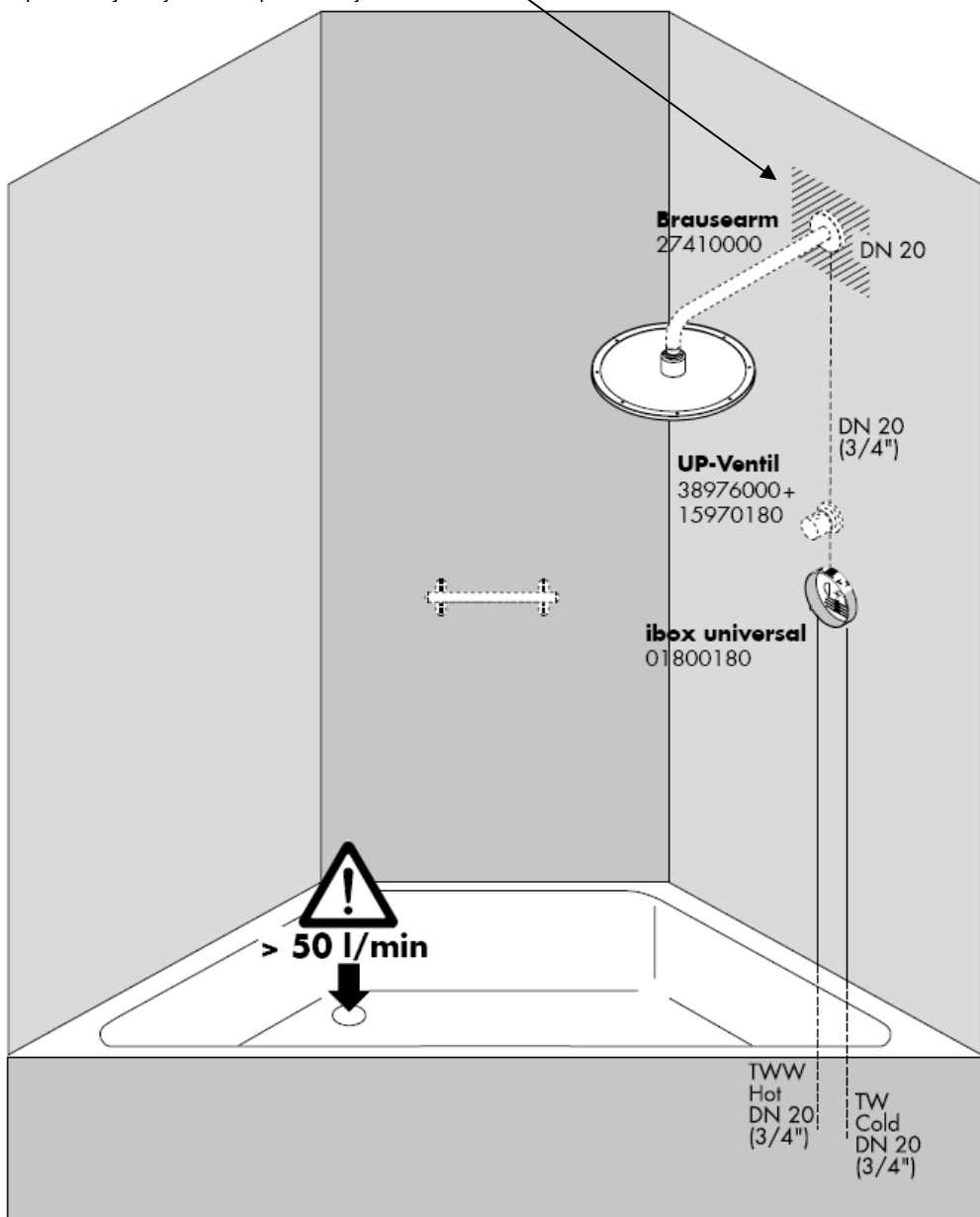

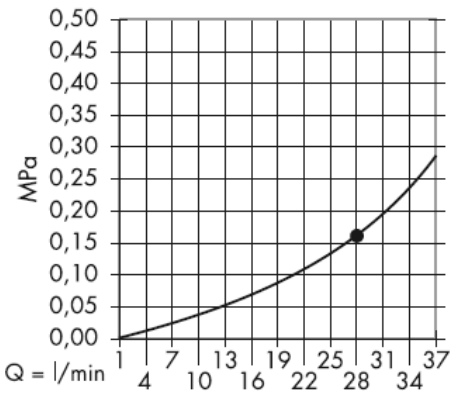

Od • je funkcija zagantovana.

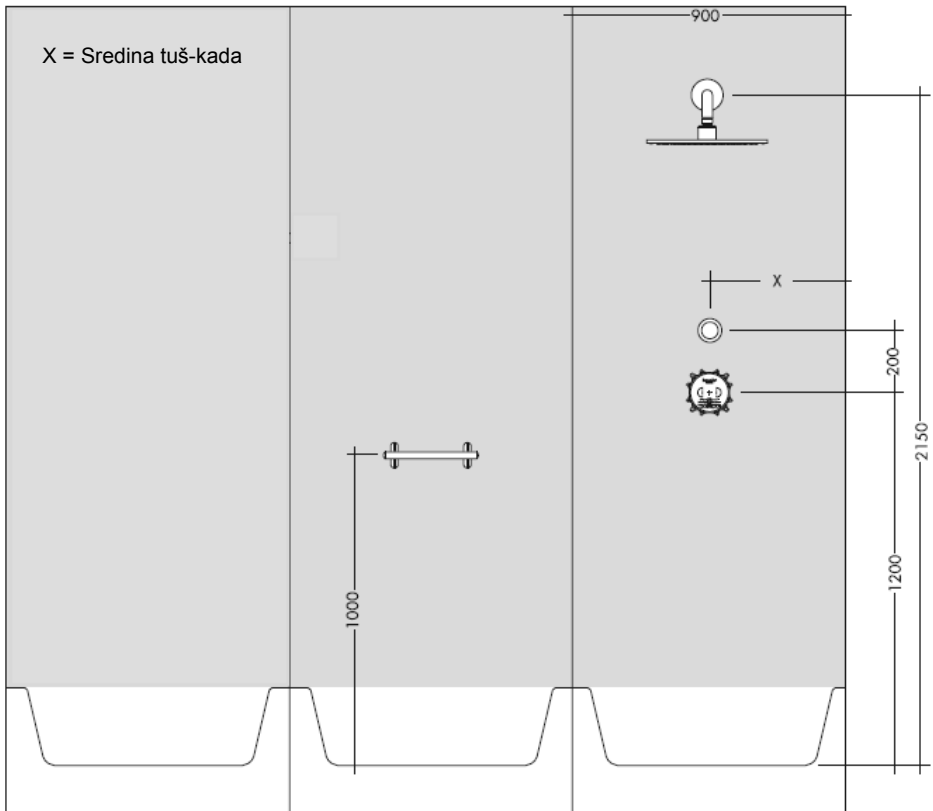

Neophodno ojačanje zida za pričvršćenje ruke tuša

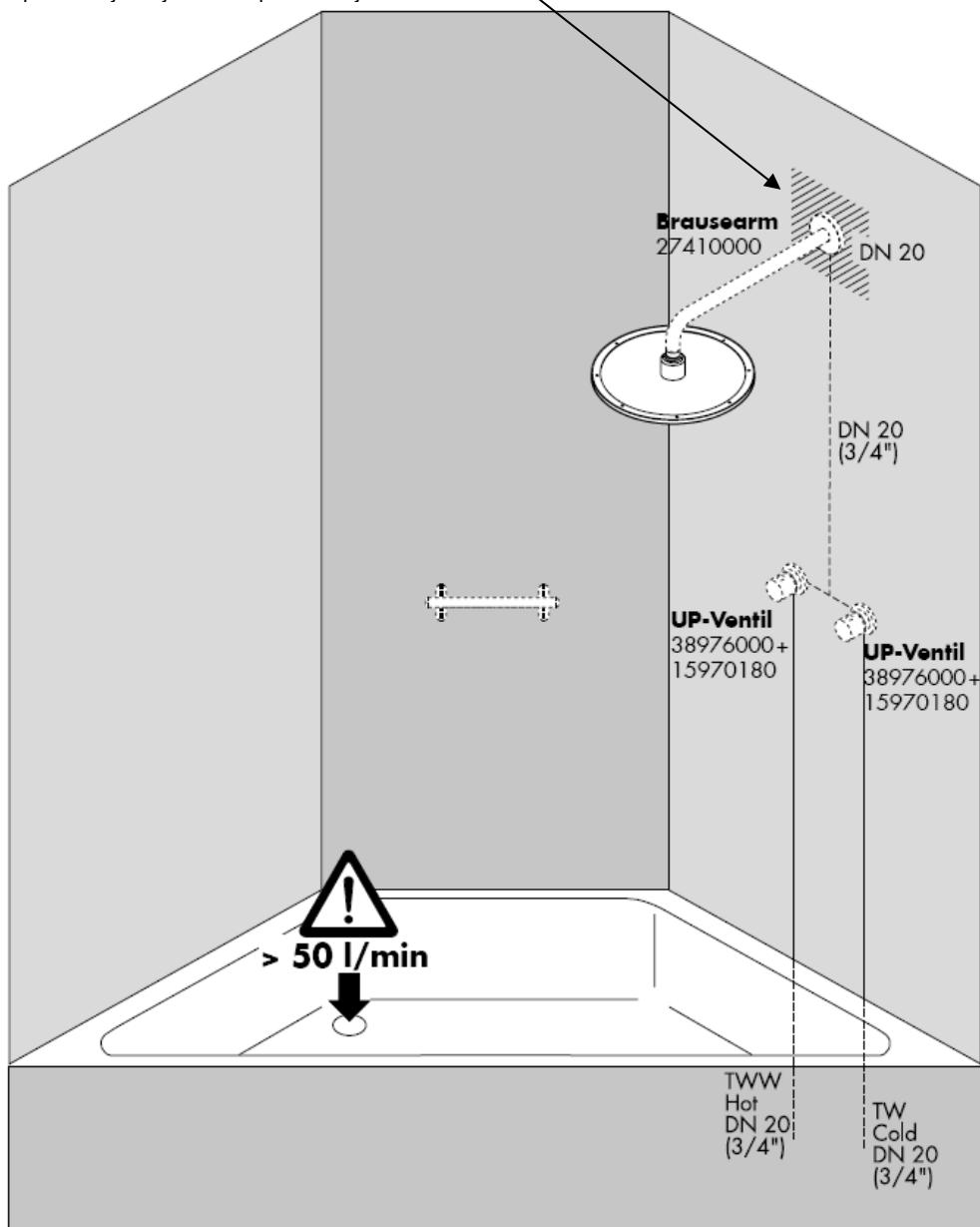

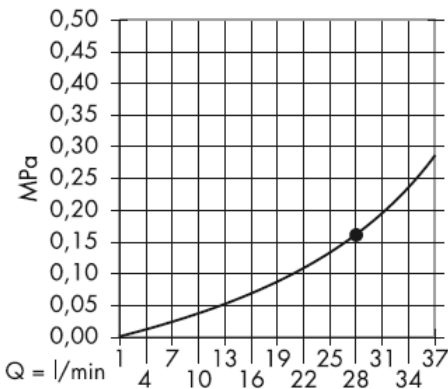

Od • je funkcija zagarantovana.

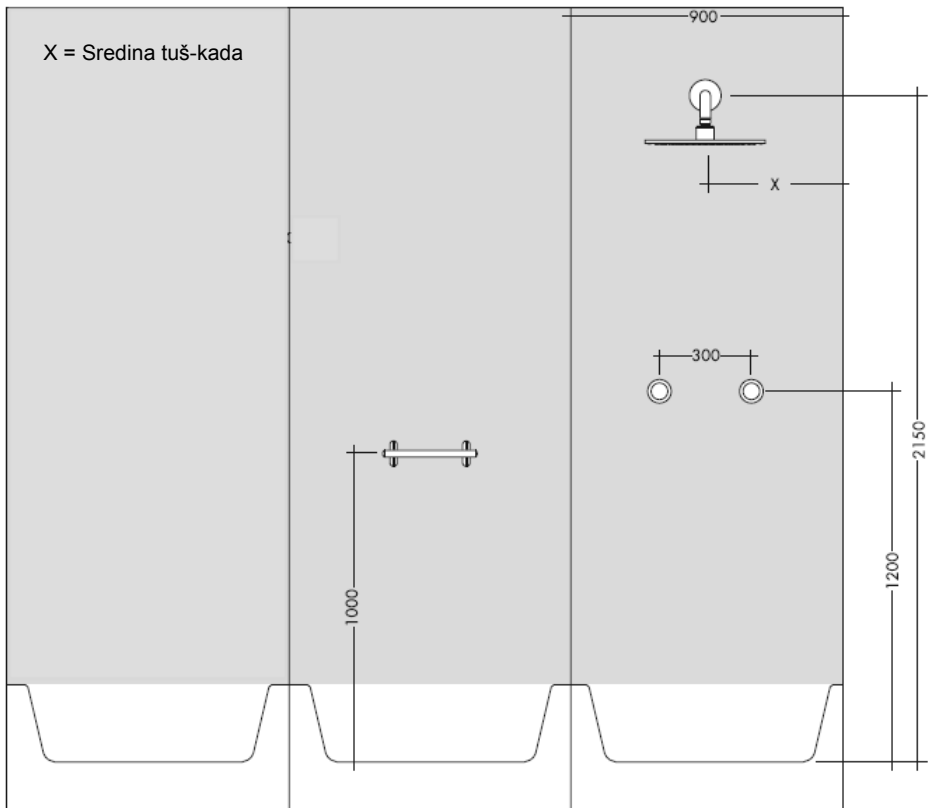

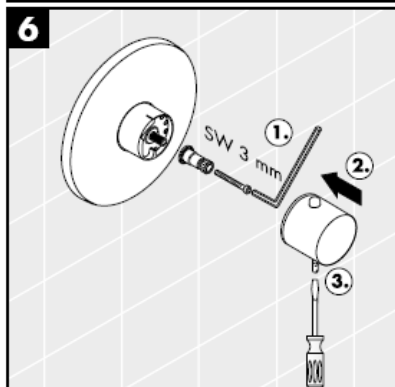
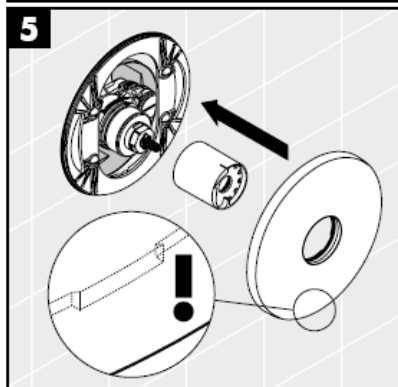
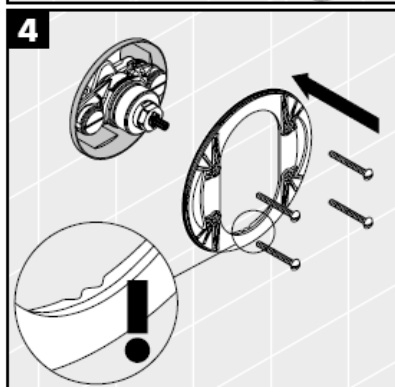
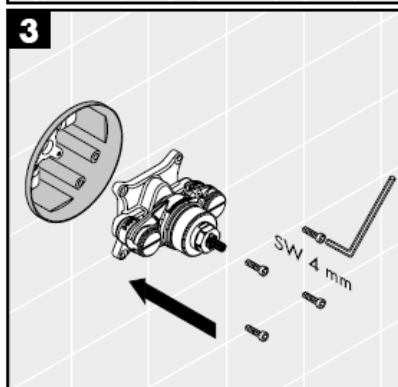
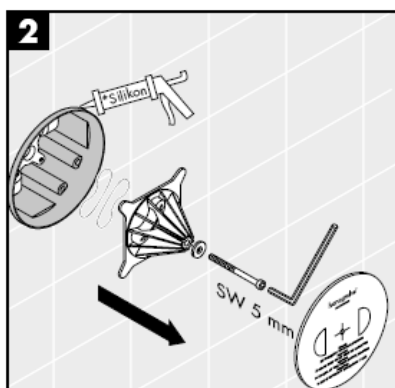
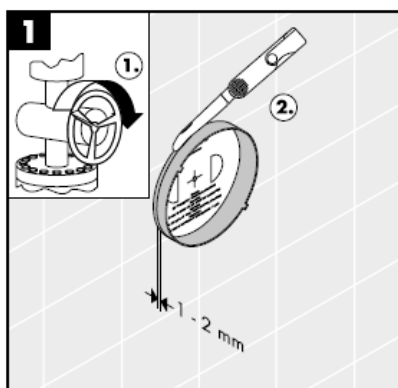

Silikon (ne sadži sirćetnu kiselinu!)

Zahvaljujuću Safety funkciji, može se podesiti željena maksimalna temperatura, npr. maks. 42 C.

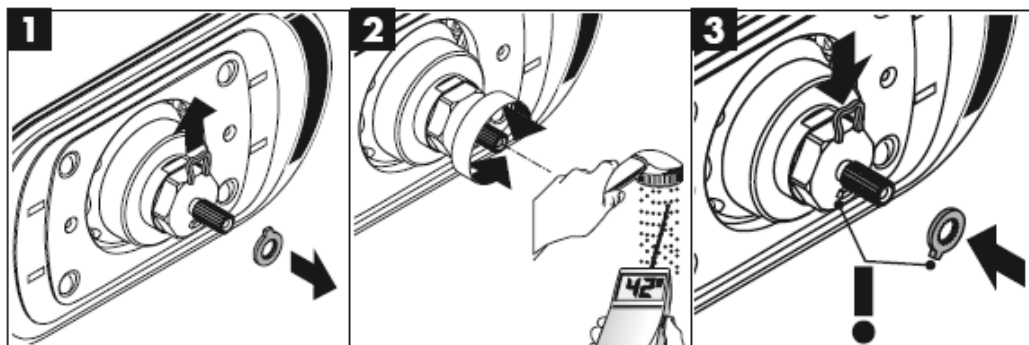

Podešavanje

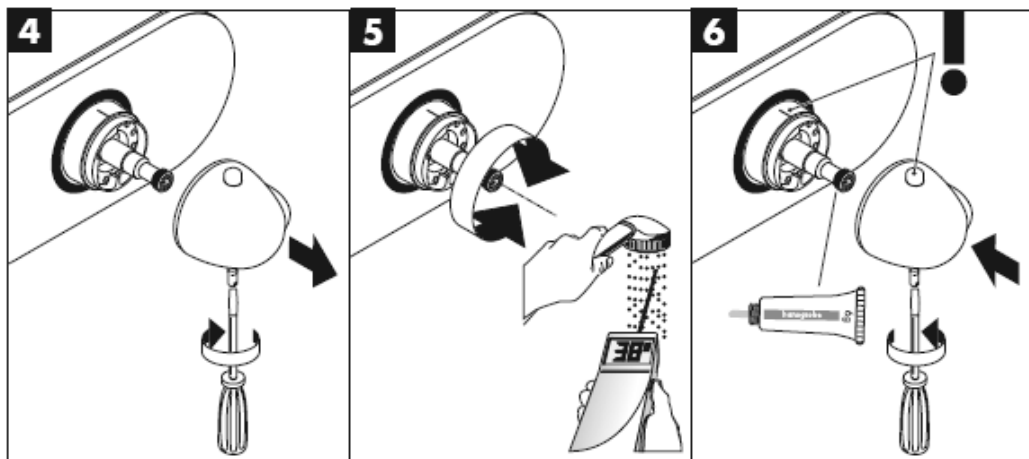



Tuš koji radi, zajedno sa nosačem tuša, težak je oko 10 kg. Zbog toga se sme koristiti samo materijal podesan za pričvršćivanje na postojeći zid! Priloženi zavrtnji i moždanici prikladni su samo za masivne zidove.

Smete koristiti jedino materijal prikladan za pričvršćivanje na postojeći zid. Priloženi zavrtnji i tiplovi prikladni su samo za masivne zidove.

Mora se predvideti dovoljan kapacitet odvoda.

Optimalna funkcija garantovana je samo u kombinaciji s Hansgrohe High Flow termostatima.

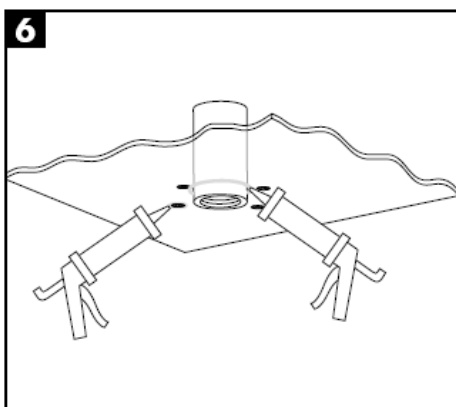
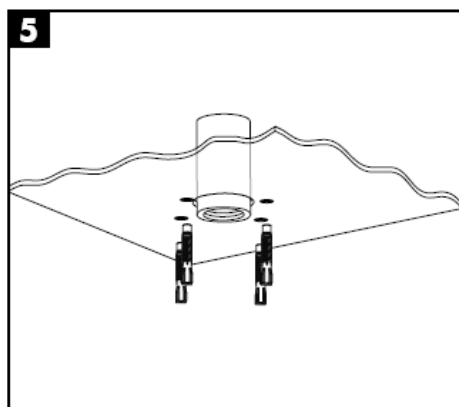
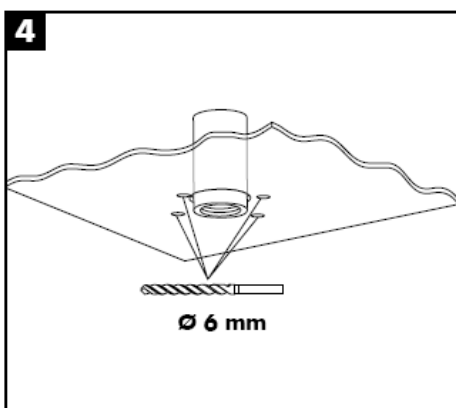
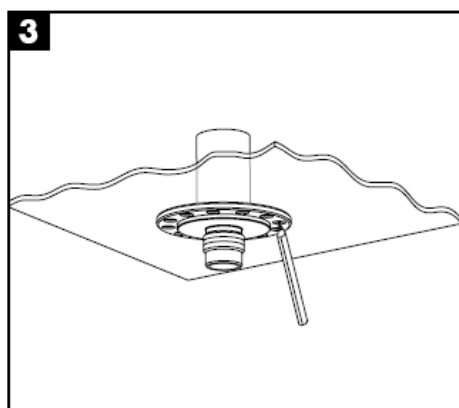
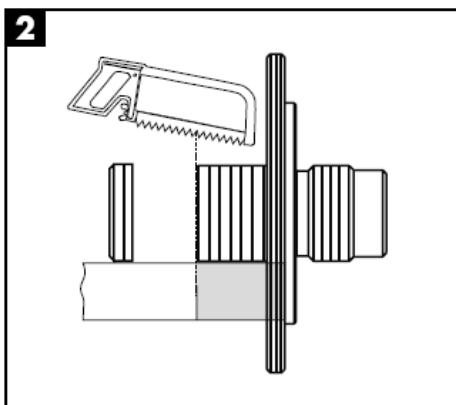
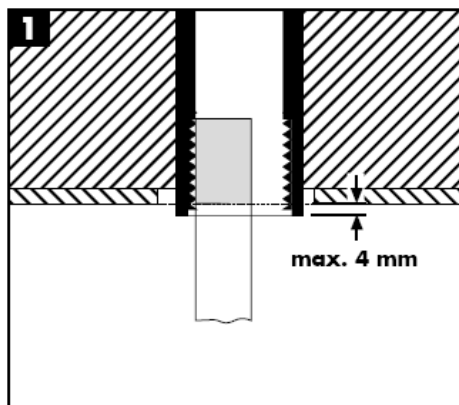

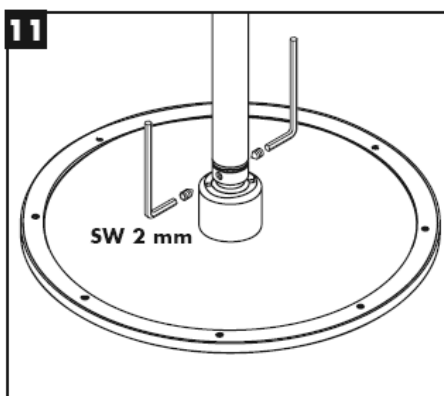
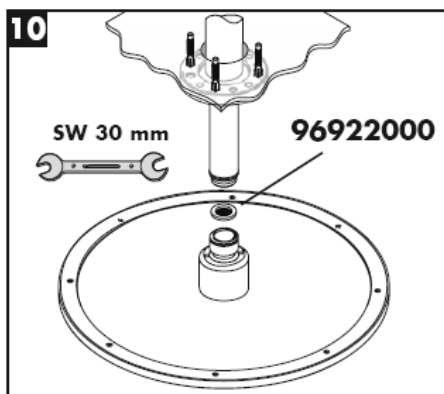
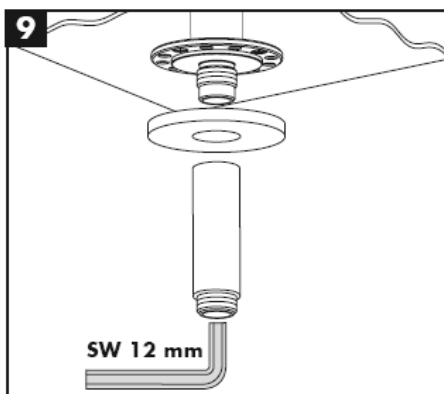
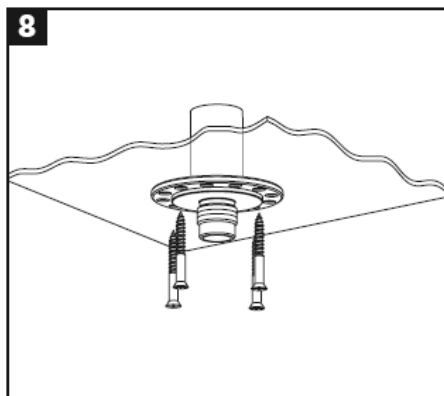
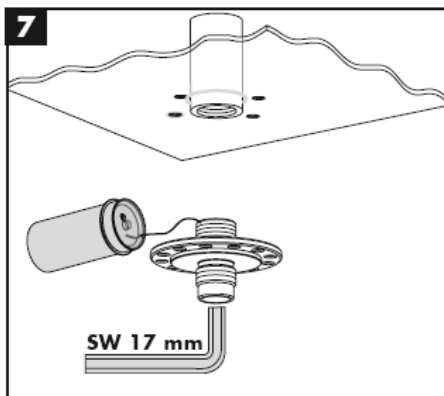

Obavezno ugradite mrežicu upakovanu s tušem, čime sprečavate ulazak prljavštine iz vodovoda. Prljavština može dovesti do delimičnog ili potpunog oštećenja delova tuša. Za eventualna oštećenja uzrokovana prljavštinom proizvođač Hansgrohe nije odgovoran.

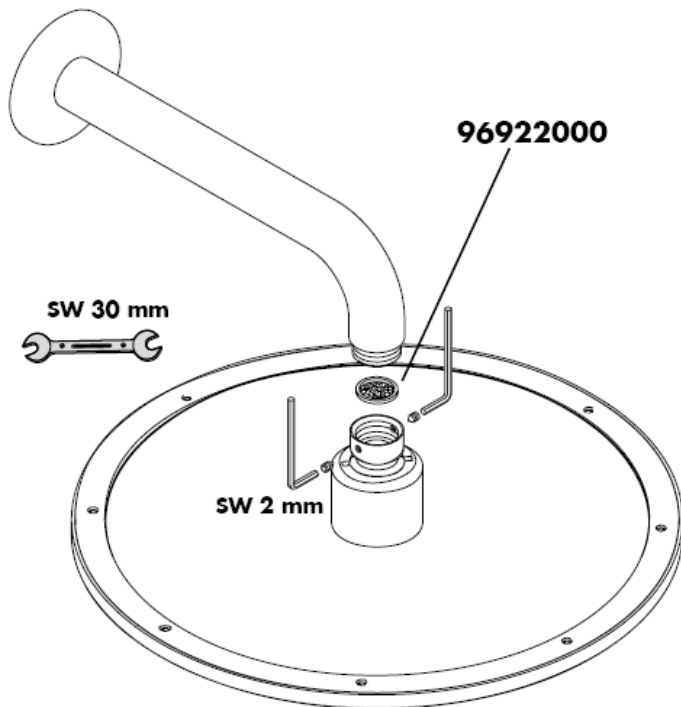

Montaža

Pažnja! Armatura mora biti postavljena, isprana i testirana prema važećim normama!

Podešavanje

Korekcija je neophodna ako izmerena temperatura odstupa od temperature koja je nameštena na termostatu. Pritom treba obratiti pažnju na sledeće:

Okrećite skalnu ručice sve dok ne počne izlaziti voda temperature 38 C. Odvratite zavrtnj ručice, povucite ručicu i okrenite je do pozicije 38 C. Zatim ponovno natakните ručicu i pričvrstite zavrtnj (vidi stranu 22).

Ograničavanje temperature

Temperaturu pomoću sigurnosne blokade možete ograničiti na 38 C (zaštita od opekotina vrućom vodom).

Ukoliko želite temperaturu višu od 38 C, pritiskom na dugme deaktivirate sigurnosnu blokadu.

Safety funkcija

Zahvaljujući Safety funkciji, može se podesiti željena maksimalna temperatura, npr. maks. 42 C. vidi stranu 21.

vidi stranu

Radni pritisak: max. 1 MPa
 Preporučeni radni pritisak: 0,1 – 0,5 MPa
 Probni pritisak: 1,6 MPa
 (1 MPa = 10 bar = 147 PSI)
 Temperatura vruće vode: max. 80° C
 Preporučena temperatura vruće vode: 65° C
 Protok vode: ca. 58 l/min 0,3 MPa

Održavanje

Nije potrebno posebno održavanje termostata. Ispravno funkcionisanje nepovratnog ventila se mora redovno proveravati prema standardu DIN EN 1717 i u skladu s važećim nacionalnim ili regionalnim propisima (DIN 1988 jednom godišnje). Takođe ispitajte ispravnost hvatača prljavštine koji se nalazi na MTC regulacionoj jedinici. (6.1). Posle instalacije MTC regulacione jedinice (6) obavezno proverite izlaznu temperaturu vode na slavini, kao što je opisano pod tačkom "Podešavanje". Pre toga svakako ispitajte da li je uključen sistem za snabdevanje toplom vodom i izlazi li na probnom mestu voda s maksimalnom temperaturom.

Kako bi se olakšala prohodnost i produžio vek trajanja regulacione jedinice, potrebno je s vremena na vreme podesiti termostat na položaje za maksimalno toplu i maksimalno hladnu vode.

Rezervni delovi vidi stranu 3

1	Ručica termostata	38391000
2	Rozeta	96452000
3	Čaura	97439000
4	Noseći zavrtnji	96454000
5	Noseća rozeta	96447000
6	Sistem za regulaciju temperature	96633000
7	Mrežica za hvatanje za prljavštine	97367000
8	Nepovratni ventil	96655000
9	Produžetak 25 mm	13595000
10	Produžetak 25 mm	13596000

Srpski

Smetnja	Uzrok	Pomoć
Nedovoljno vode	-Prenizak pritisak vode -Očistite mrežicu za hvatanje prljavštine regulacione jedinice -Mrežasta zaptivka tuša je prljava	-Ispitajte pritisak u cevima -Očistite mrežicu za hvatanje prljavštine ispred termostata i na regulacionoj jedinici -Očistite mrežastu zaptivku između tuša i crijeva
Ukršteni tok vode, kod zatvorene armature vruća voda ulazi u cev s hladnom vodom i obrnuto	-Nepovratni ventil je prljav / neispravan	-Zamenite nepovratni ventil
Temperatura na slavini se ne podudara s podešenom temperaturom	-Termostat nije podešen -Preniska temperatura tople vode	-Podesite termostat -Povećajte tempereturu vruće vode na 42-65 C
Regulisanje temperature nije moguće	-Regulator temperature je prljav ili obložen naslagama kamenca -Unutrašnji blok okrenite za 180 stepeni	-Pri ponovnoj instalaciji telo je pogrešno priključeno (potrebno je priključiti hladnu vodu desno, a vruću levo) ili je zakrenuto za 180 stepeni. -Dugme sigurnosnog prekida je van funkcije
Opruga je neispravna	-Očistite i podmažite oprugu, tj. dugme, u slučaju potrebe dugme možete zameniti novim -Dugme je začepljeno slojem kamenca	-Očistite i podmažite oprugu, tj. dugme, u slučaju potrebe dugme možete zameniti novim -Očistite i podmažite oprugu, tj. dugme, u slučaju potrebe dugme možete zameniti novim

Ispitni znak

	P-IX	DVGW	SVGW	WRSA	KIWA	ACS	NF
27070000						X	
27418XXX							
28420000						X	
28435XXX						X	

Čišćenje

Jednostavno čisto: Kamenac se sasvim lako skida sa izbočina.

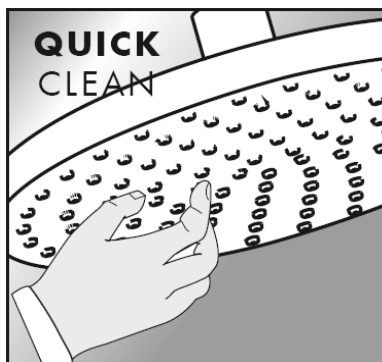

Uputstvo za održavanje

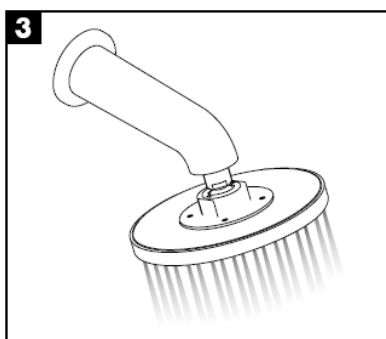
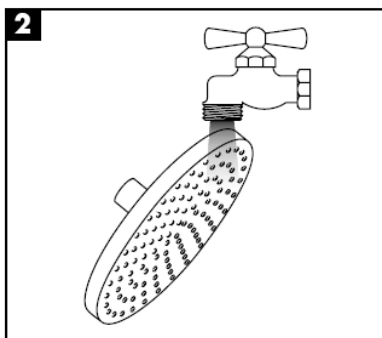
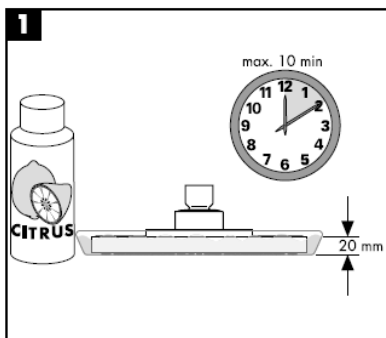

hansgrohe

Montasjeveiledning



27418XXX

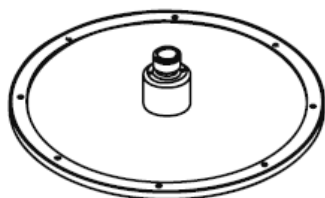

Raindance Royale AIR
28420000

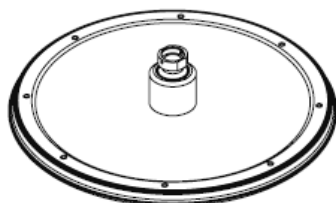

Raindance Royale Classic AIR
28435XXX

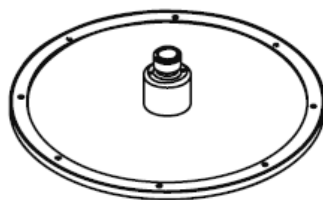

**Raindance Royale
High Flow Set**
27070000

hangrohe

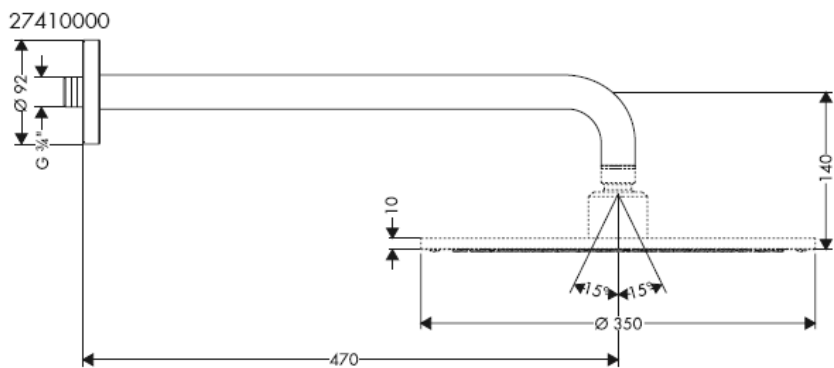
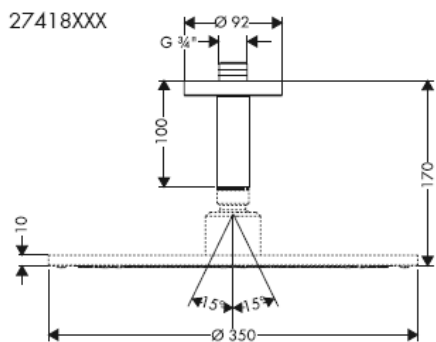
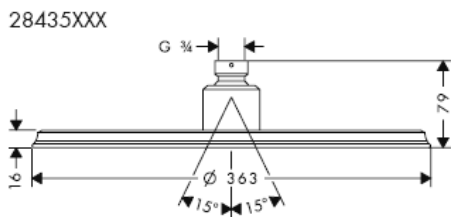
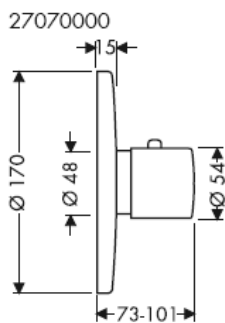
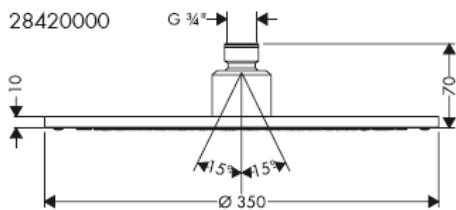

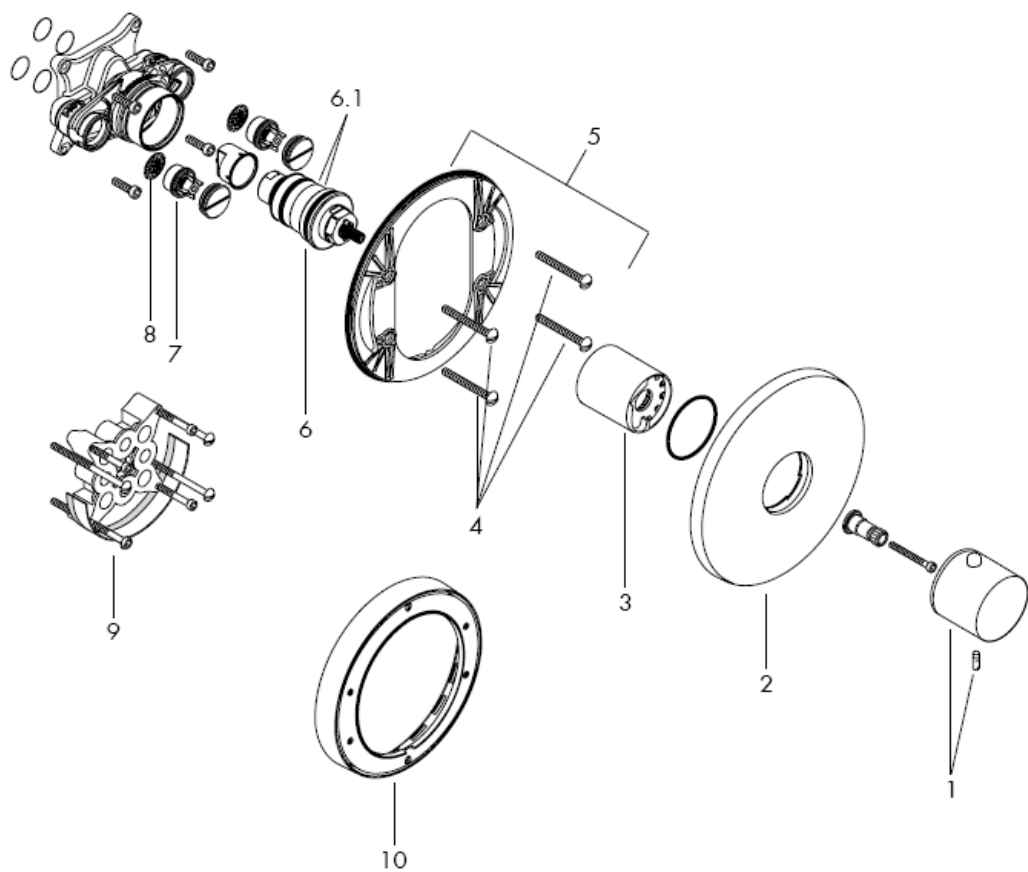

Hvis det er mulig tilpasses mål til fliseraster.

Nødvendig med veggforsterkning for dusjarmfeste

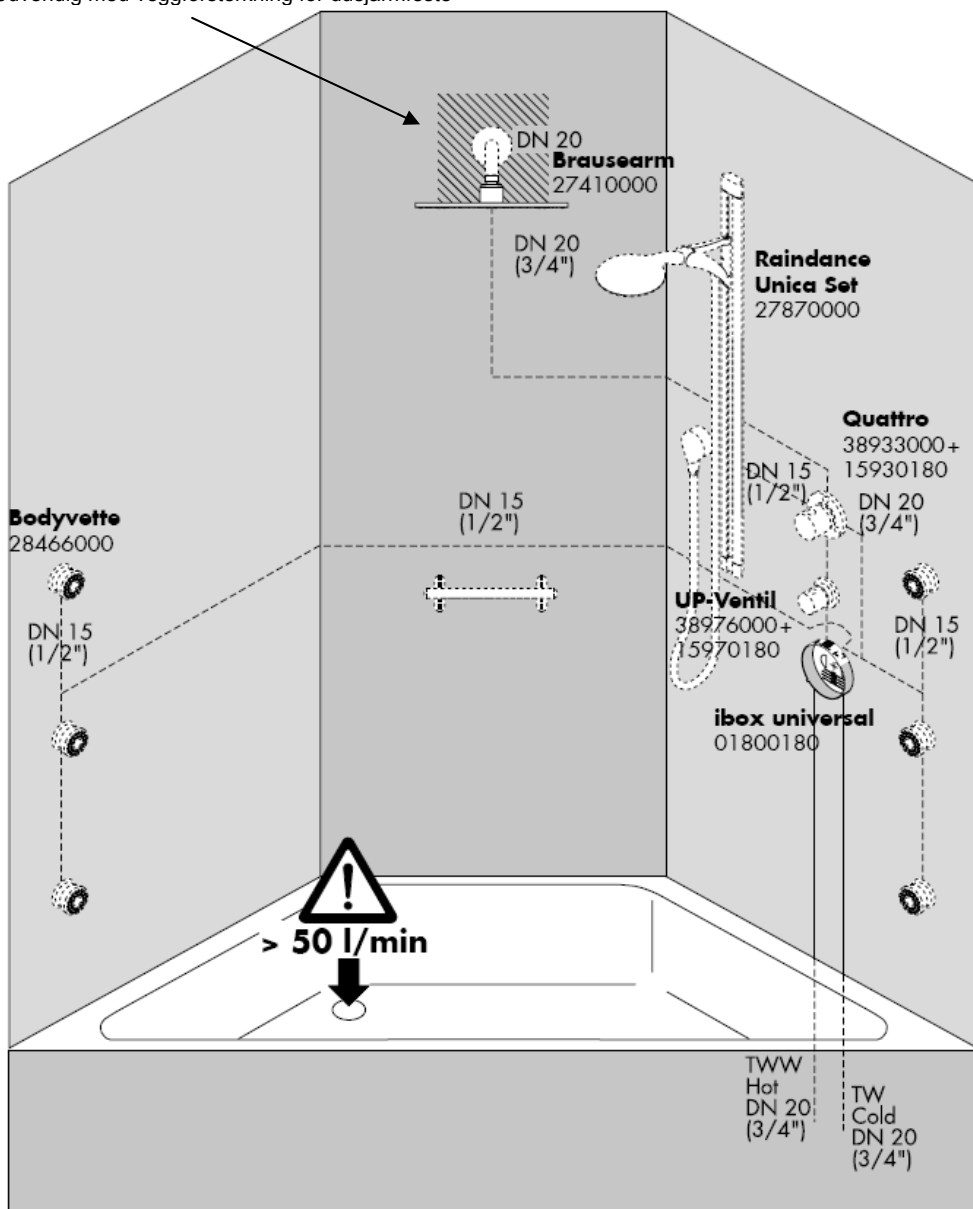

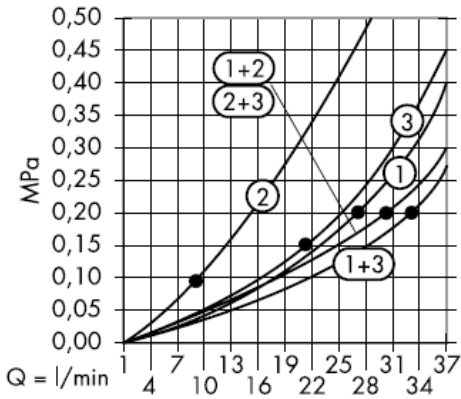

F.o.m. • er funksjonen garantert

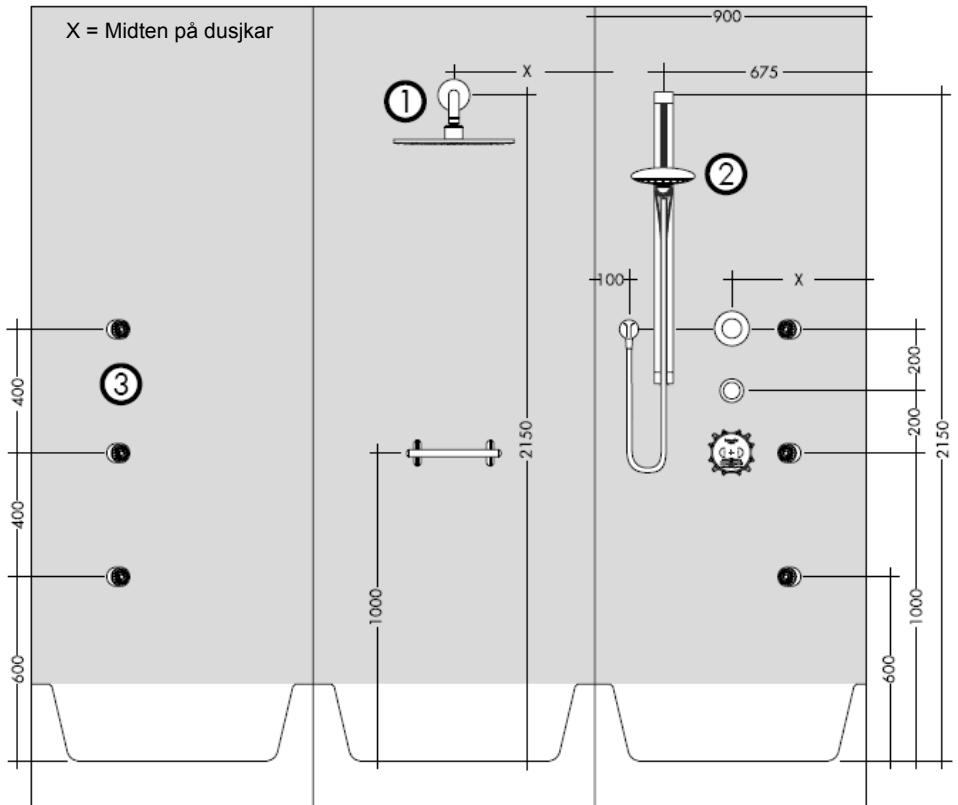

Nødvendig med veggforsterkning for dusjarmfeste

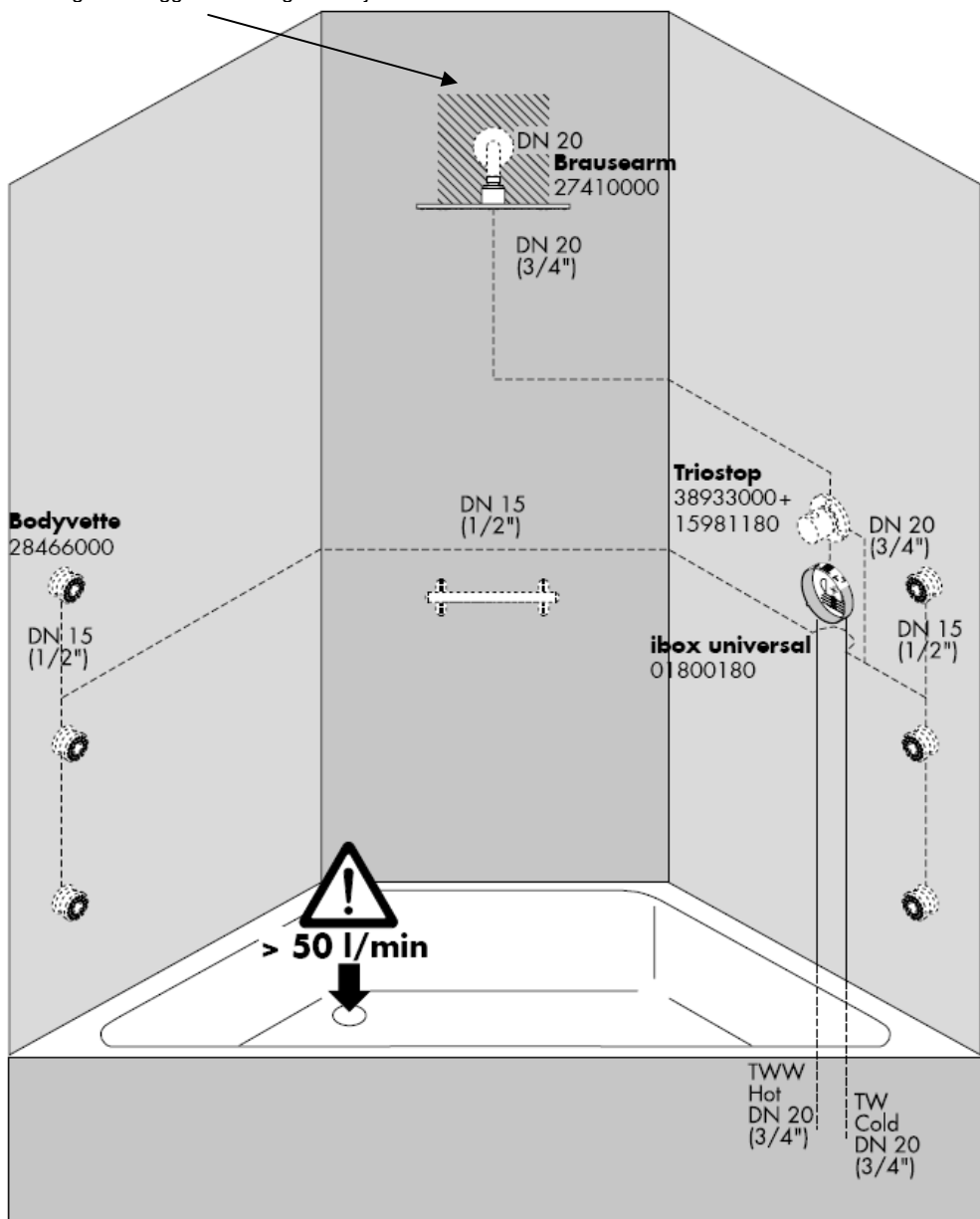

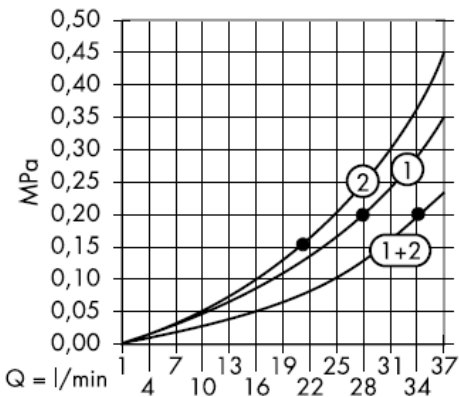

F.o.m. • er funksjonen garantert

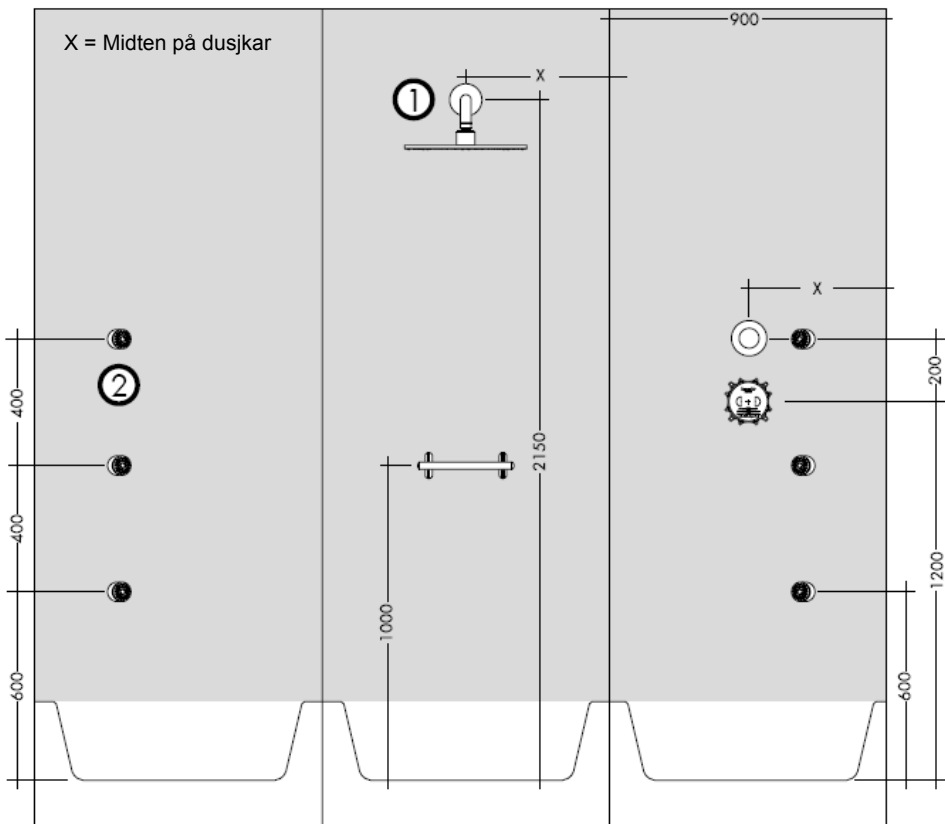

Nødvendig med veggforsterkning for dusjarmfeste

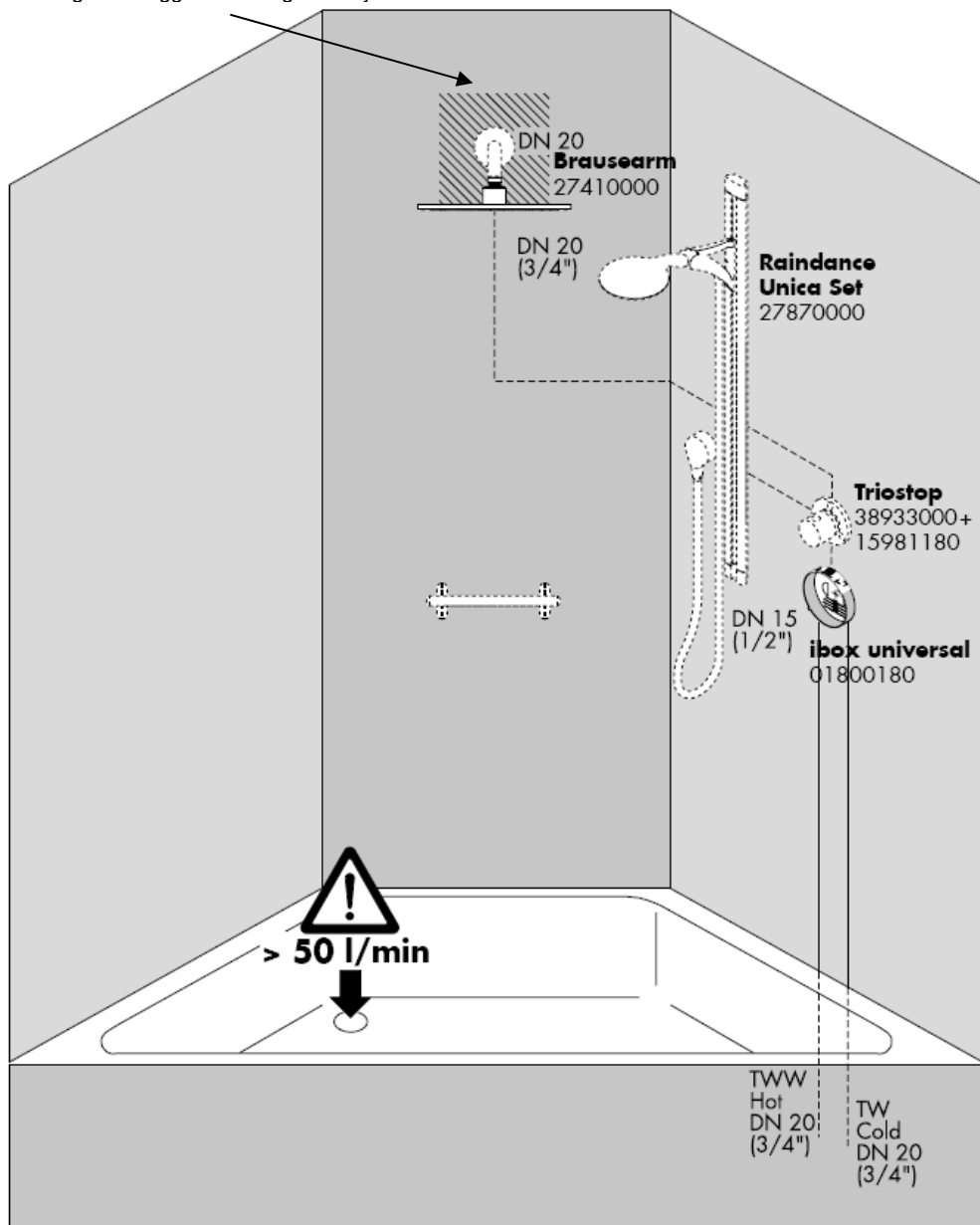

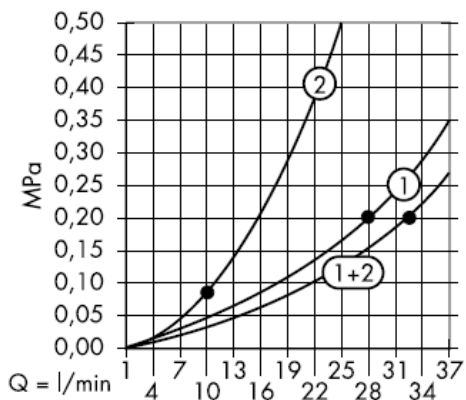

F.o.m. • er funksjonen garantert

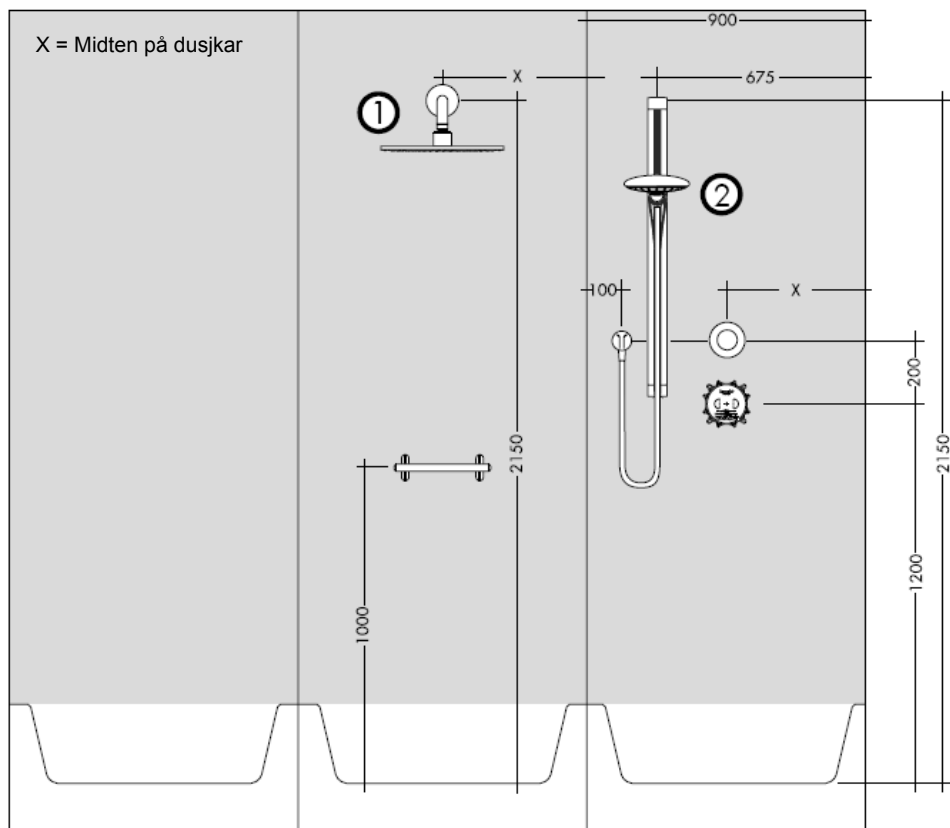

Nødvendig med veggforsterkning for dusjarmfeste

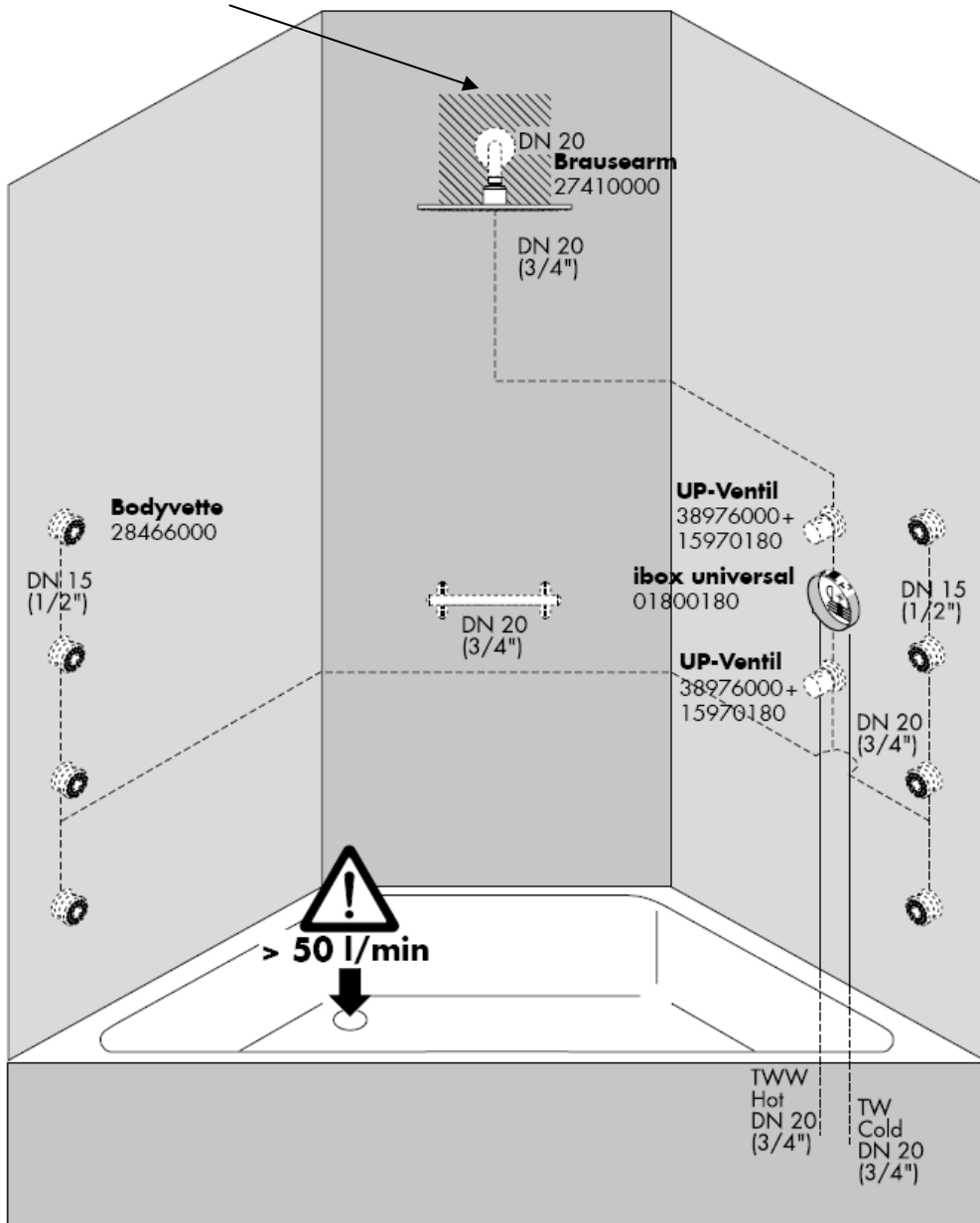

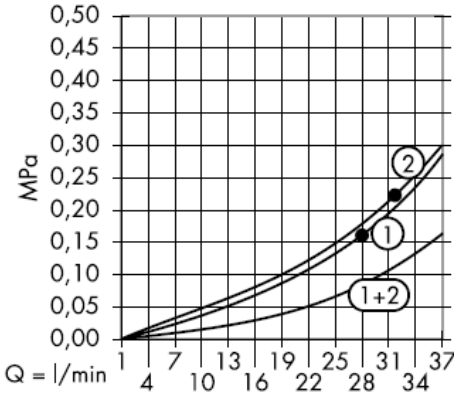

F.o.m. • er funksjonen garantert

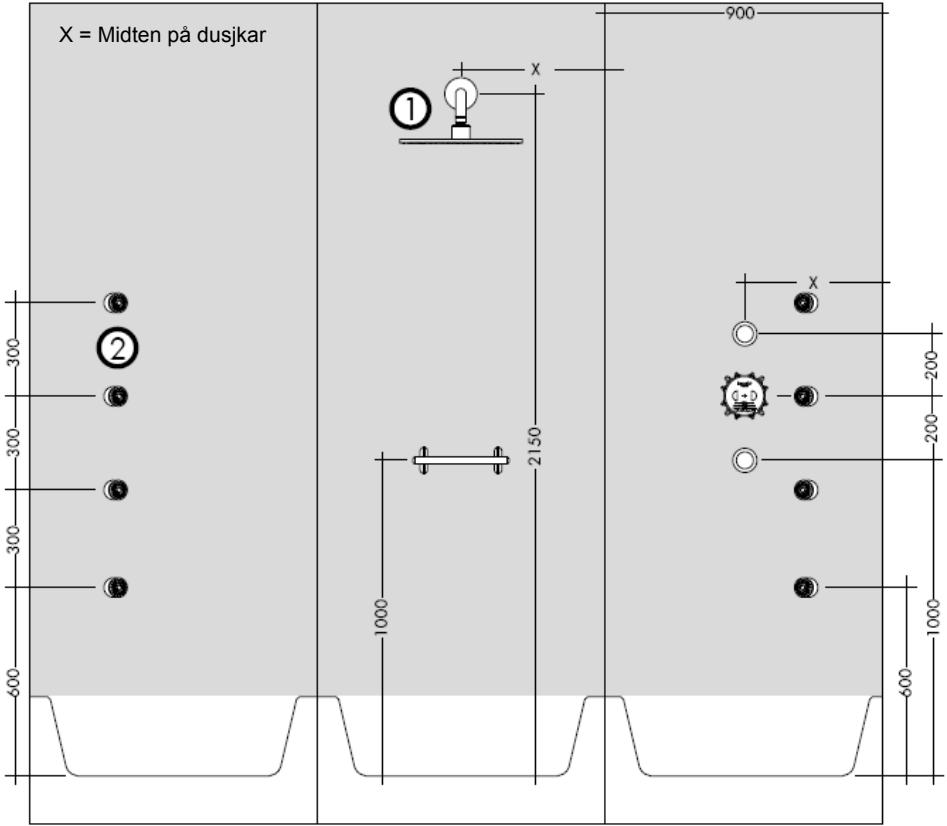

Nødvendig med veggforsterkning for dusjarmfeste

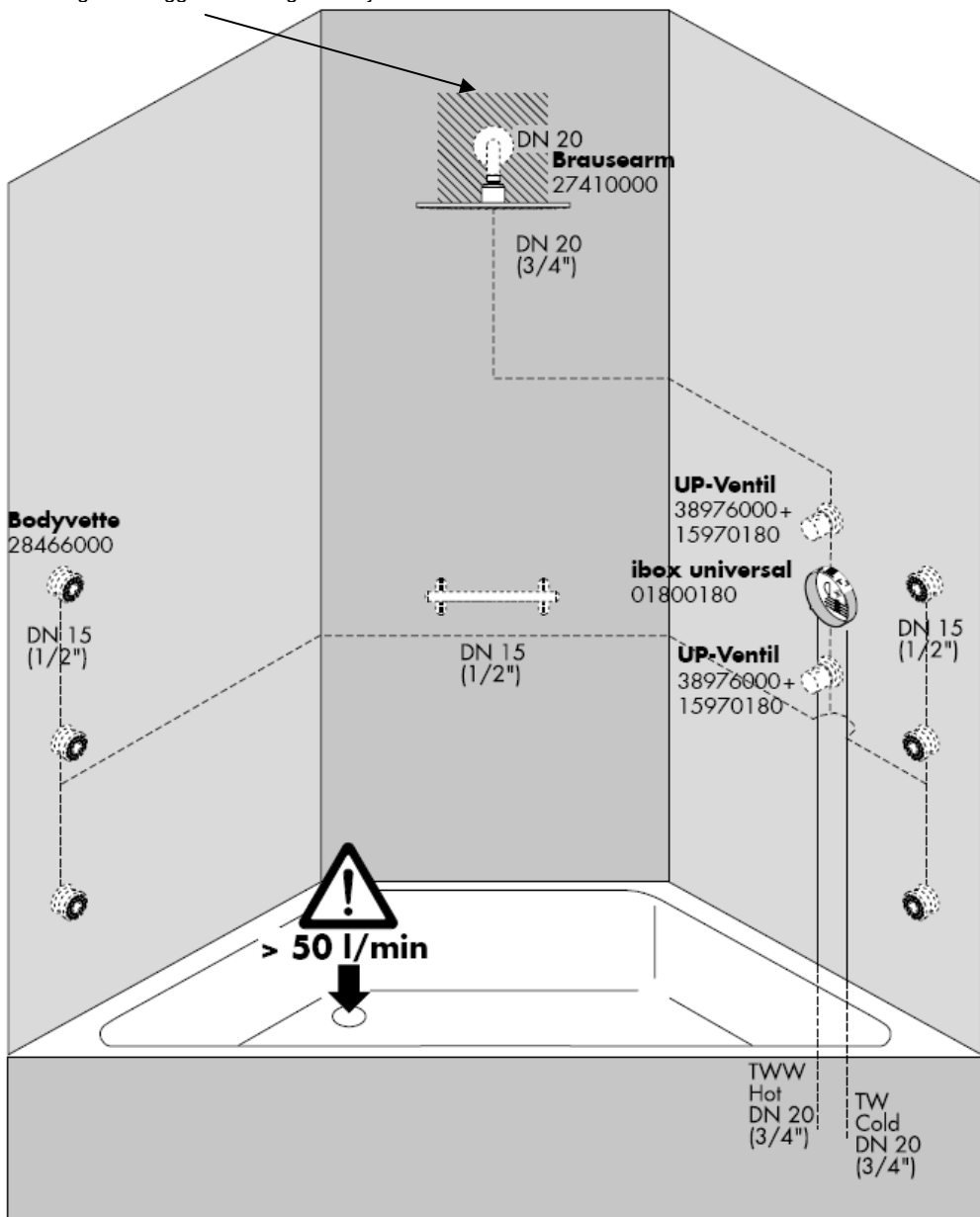

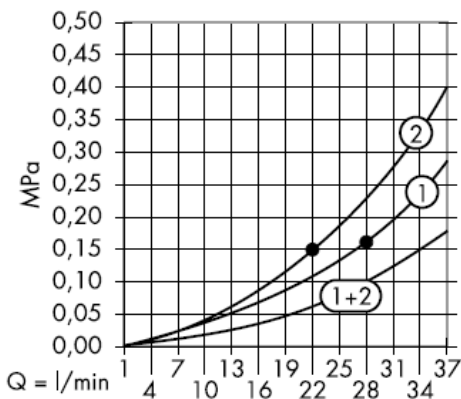

F.o.m. • er funksjonen garantert

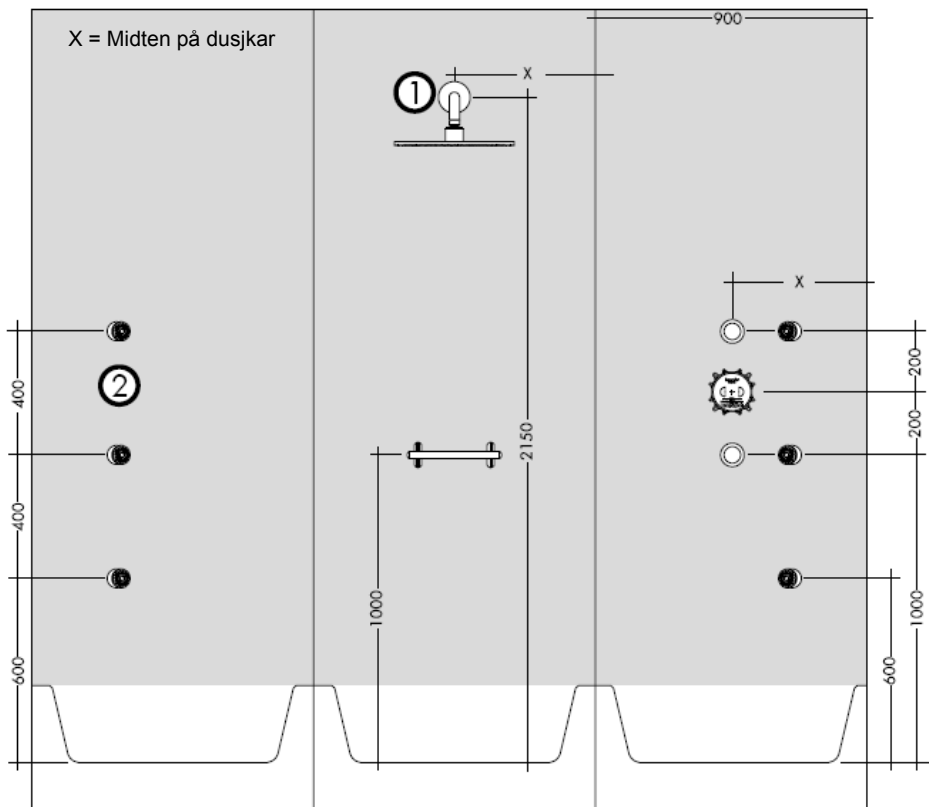

Nødvendig med veggforsterkning for dusjarmfeste

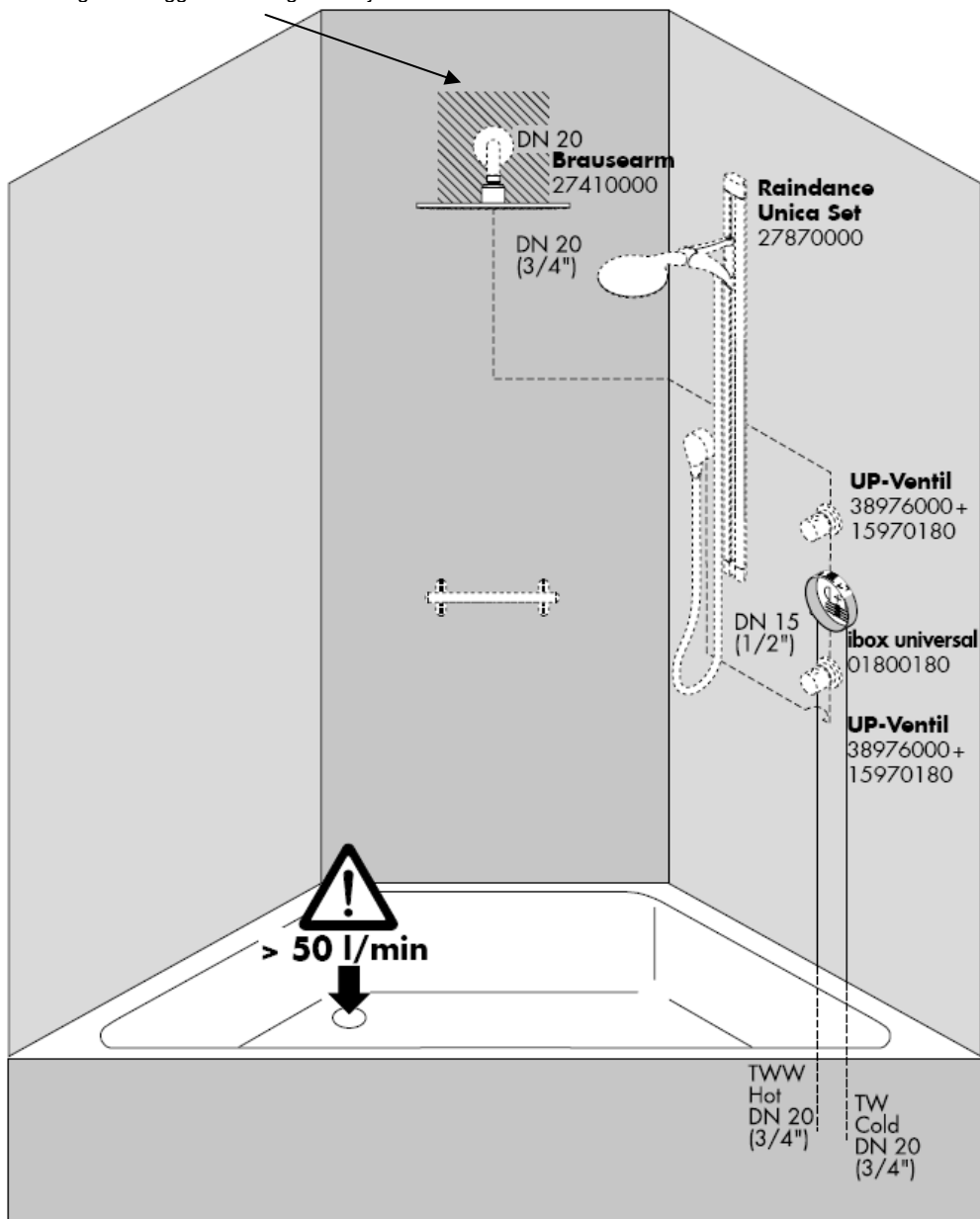

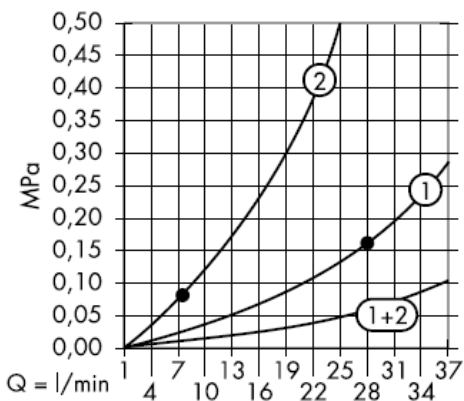

F.o.m. • er funksjonen garantert

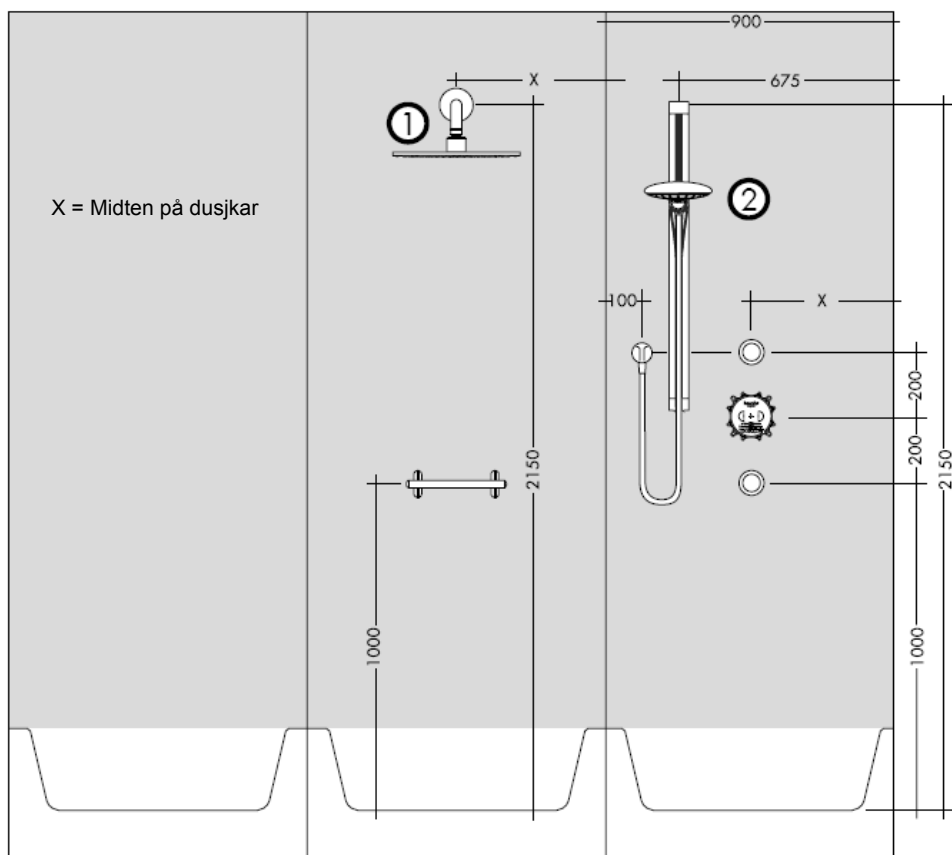

Nødvendig med veggforsterkning for dusjarmfeste

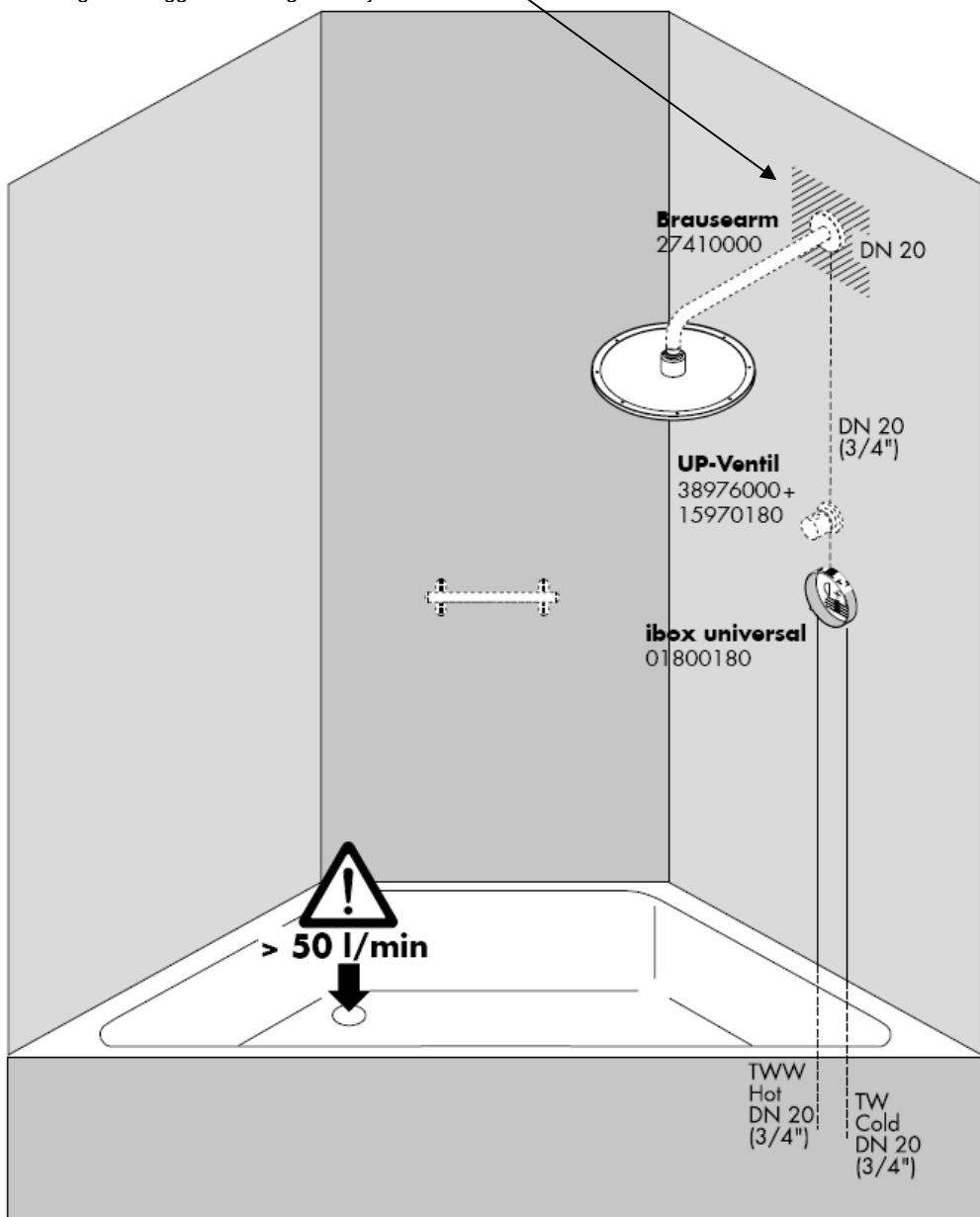

F.o.m. • er funksjonen garanterert

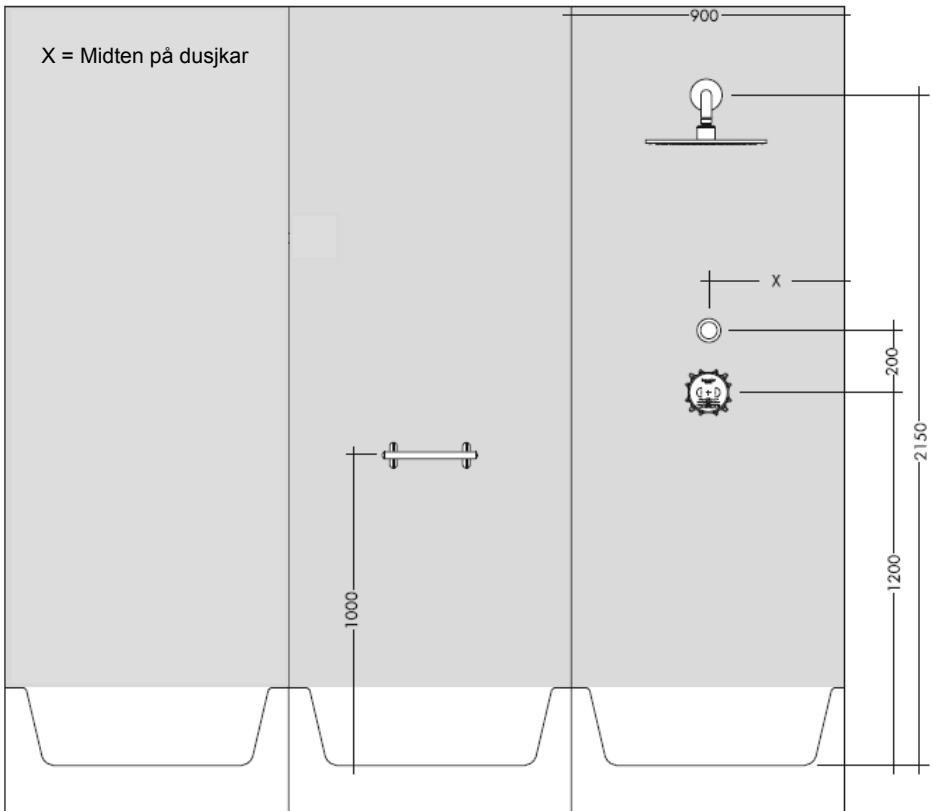
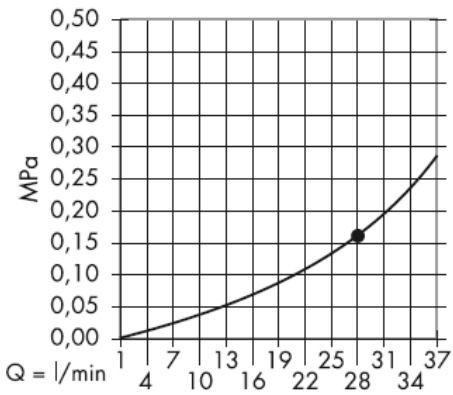

Nødvendig med veggforsterkning for dusjarmfeste

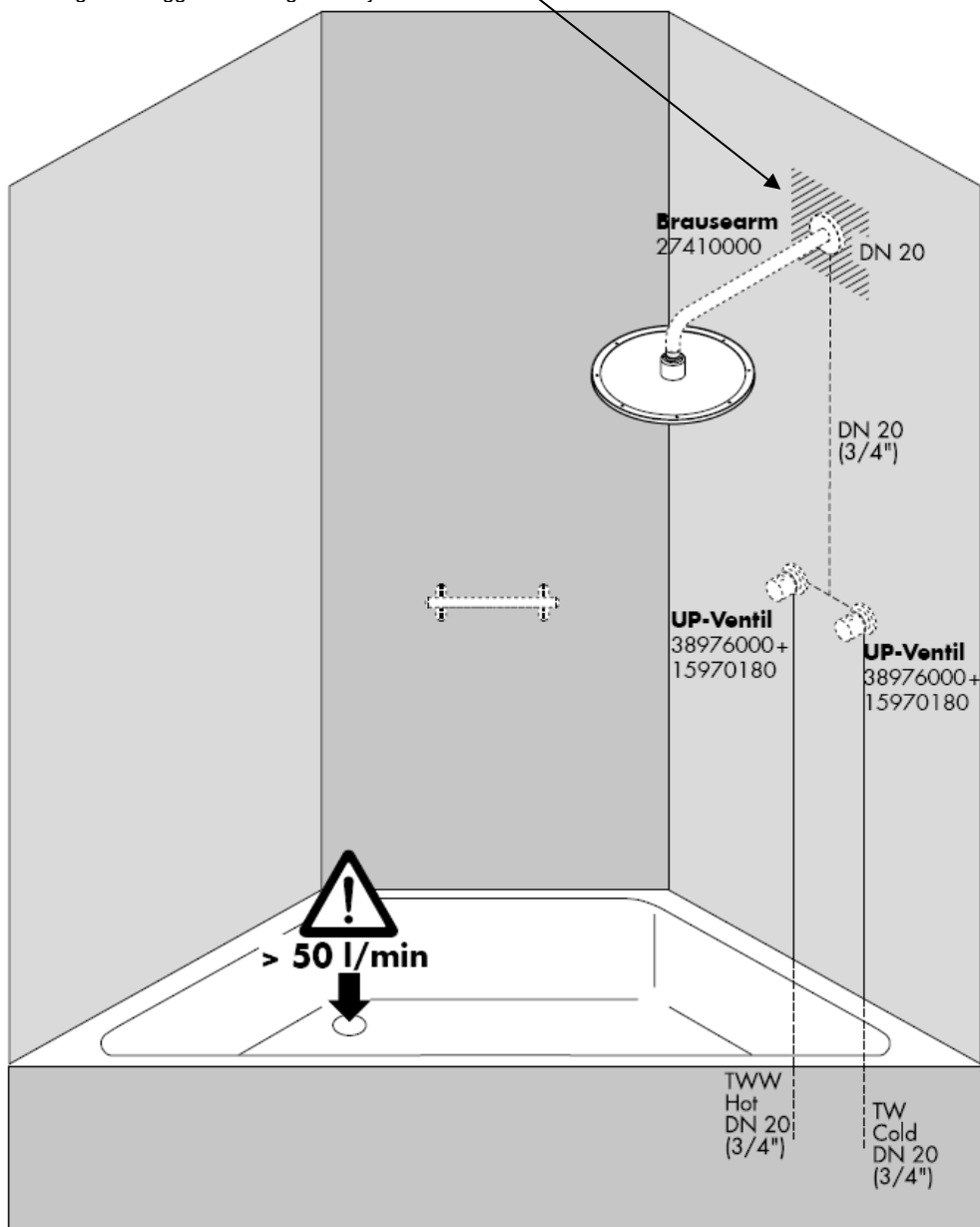

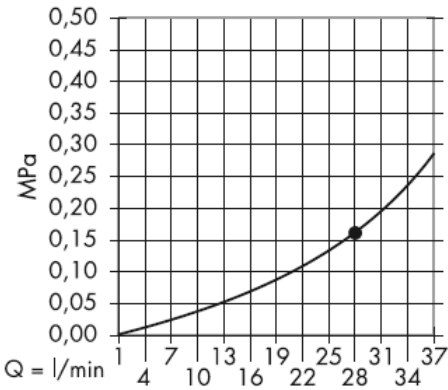

F.o.m. • er funksjonen garantert

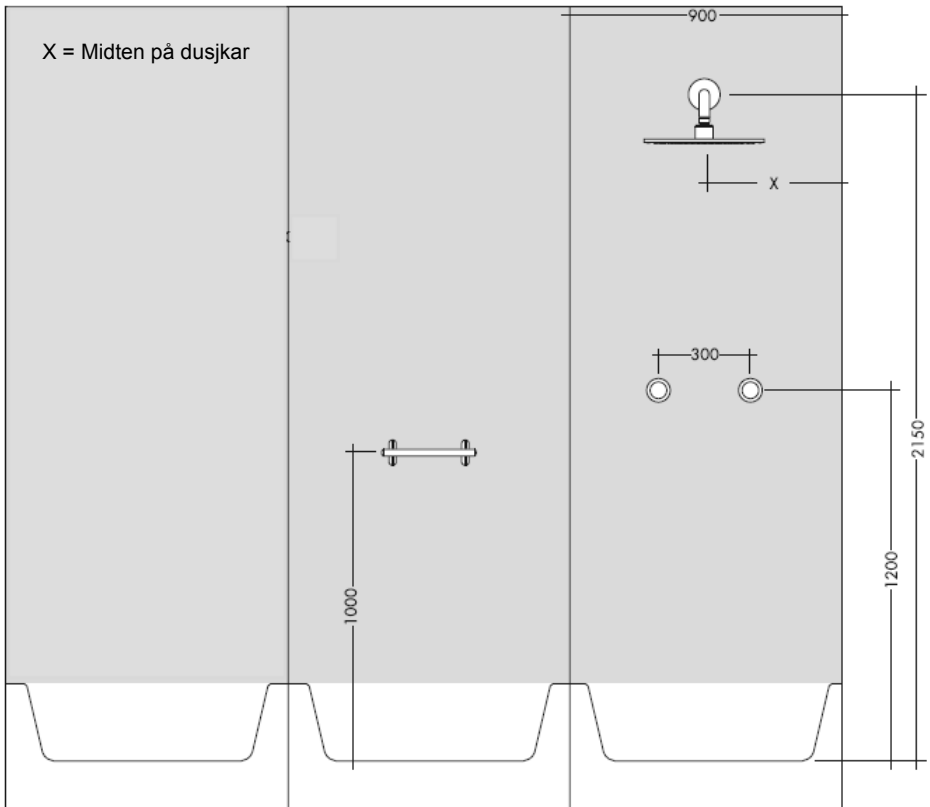

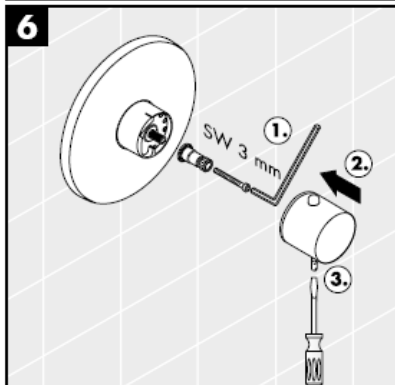
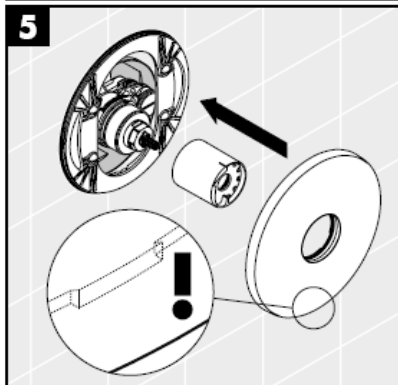
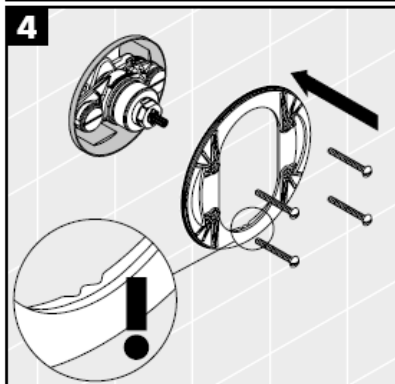
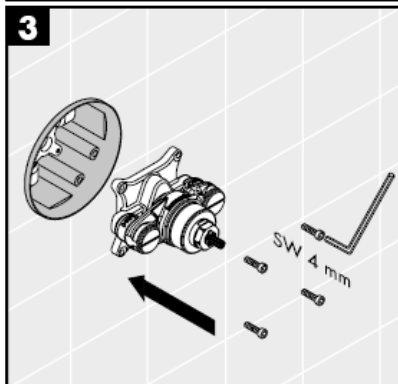
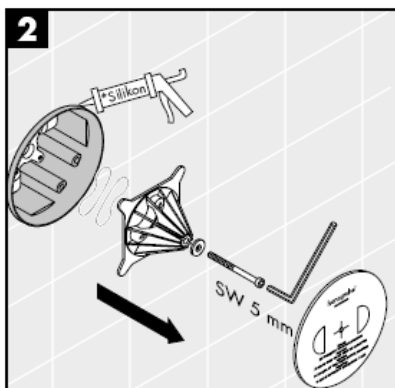
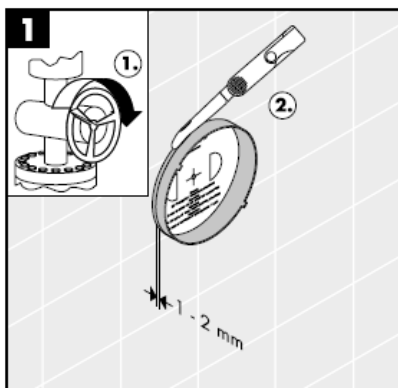

Silikon (uten eddiksyre)

Takket være egenskapen "Safety Function" kan det forhåndsinnstilles en ønsket maks. temperatur, f.eks. 42 C.

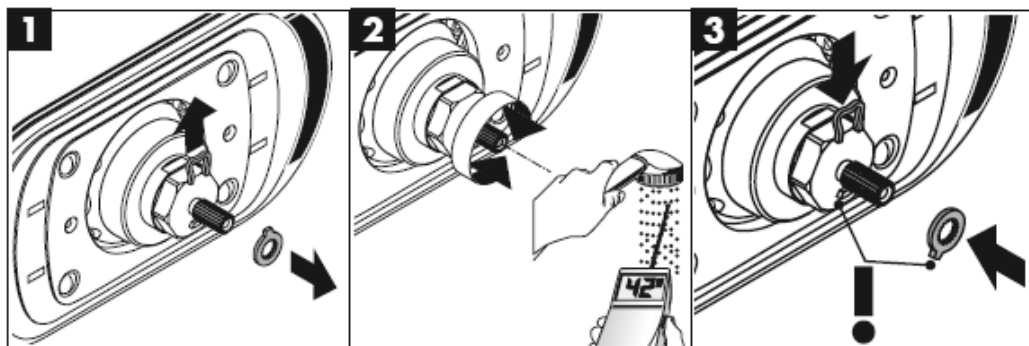

Justering

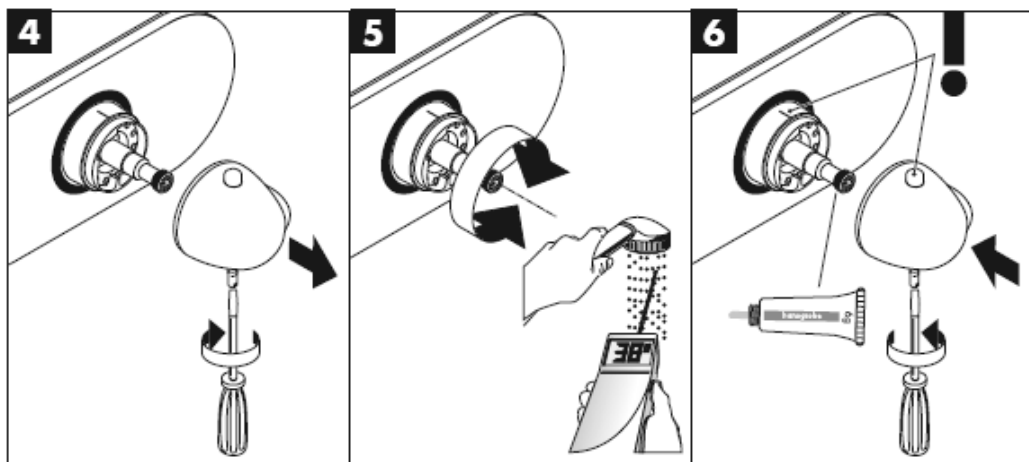



Når dusjen er i funksjon har den sammen med dusjarmen, en vekt på omtrent 10 kg. Derfor skal det kun brukes festematerial som er egnet for murverket! Medleverte skruer og plugg er egner seg kun for massivt murverk.

Det skal kun brukes festematerial som er egnet for murverket! Medleverte skruer og plugg er egner seg kun for massivt murverk.

Utløpsytelsen skal være tilstrekkelig dimensjonert.

Optimal funksjon garanteres kun i forbindelse med Hansgrohe High Flow termostater.

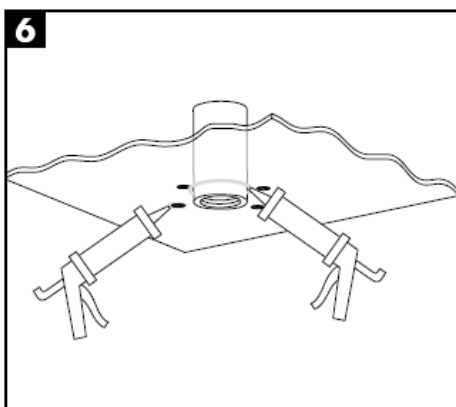
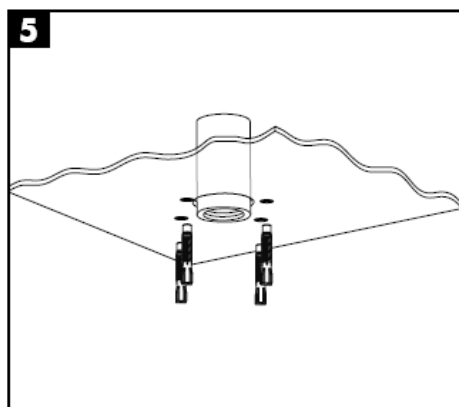
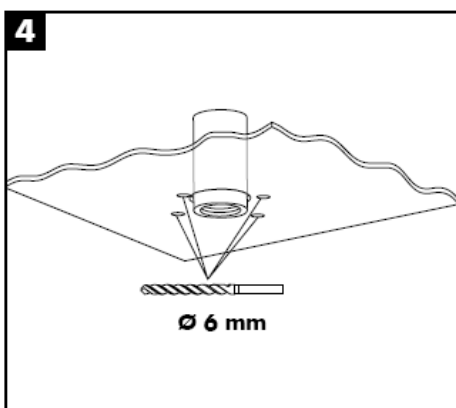
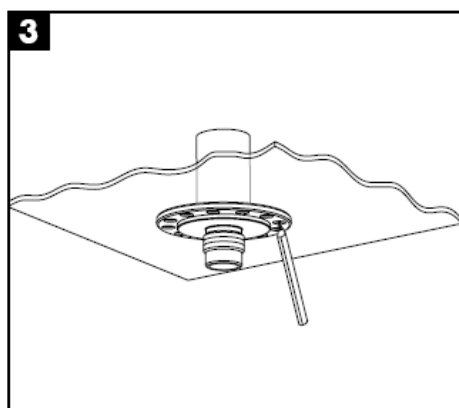
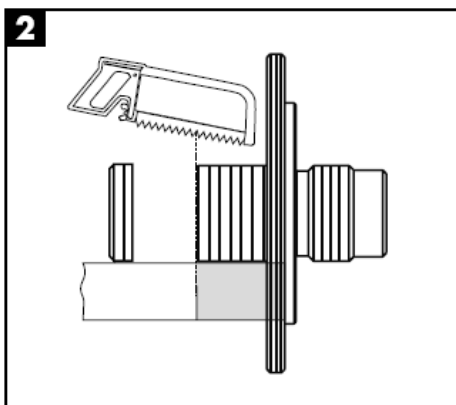
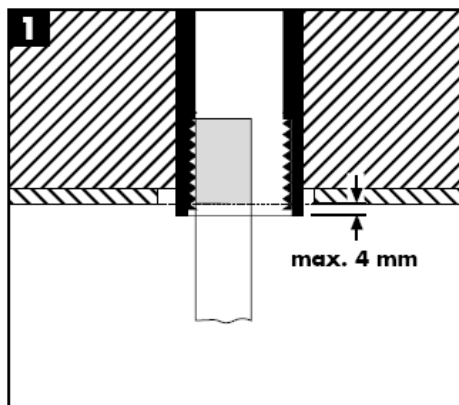

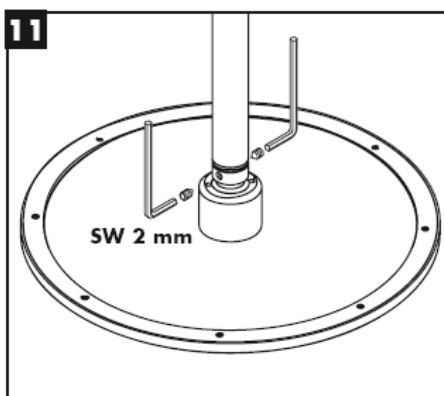
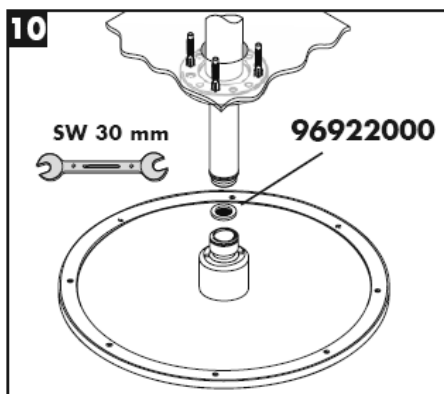
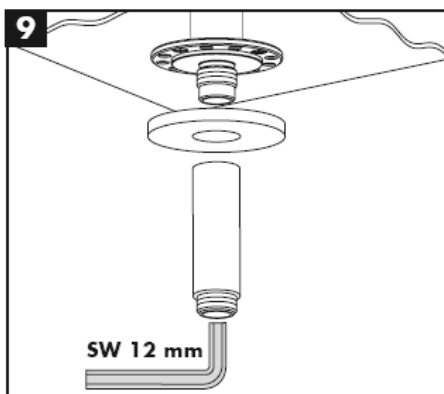
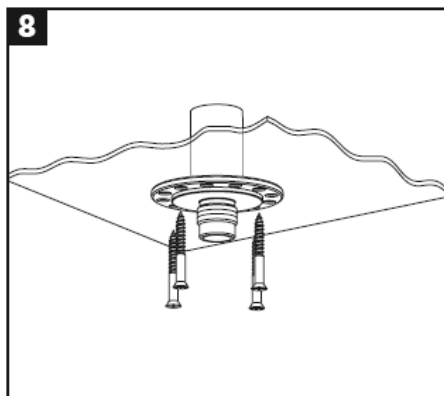
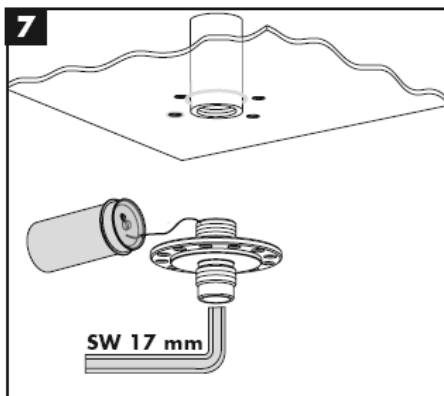

Silpakningen som er levert med dusjen skal bygges inn for å forhindre at smuss spyles inn fra ledningsnett. Innspylt smuss kan påvirke funksjonen negativt og/eller kan medføre skader på hånddusjens funksjonsdeler. Hansgrohe påtar seg inget ansvar for skader som resulteres av dette.

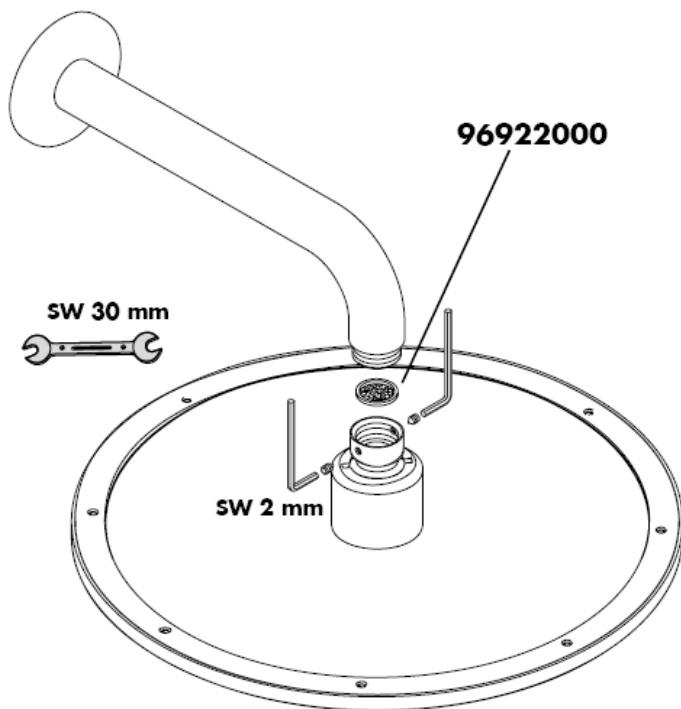

Montasje

Obs! Armaturen skal monteres iht. gyldige standarder. De skal spyles og sjekkes!

Justering

Det er nødvendig med korrektur når temperaturen målt ved uttaksstedet avviker fra temperaturen som er innstilt på termostaten. Her skal man passe på følgende: Skalegrep dreies inntil vann med 38 °C kommer ut av uttaksstedet. Grepskruen løsnes, grepet trekkes tilbake og dreies til stilling for 38 °C. Grep settes på igjen og grepskruen trekkes fast (se side 22).

Temperaturbegrensning

Temperaturområdet begrenses til 38 °C ved hjelp av sikkerhetssperringen. Ønsker man en høyere temperatur enn 38 °C kan sperringen deaktiveres ved trykk på sikkerhetsknappen.

Safety Function

Takket være egenskapen "Safety Function" kan det forhåndsinnstilles en ønsket maks. temperatur, f.eks. 42 °C. se side 21.

Tekniske data

Tekniske data	max. 1 MPa
Anbefalt driftstrykk:	0,1 – 0,5 MPa
Prøvetrykk	1,6 MPa
(1 Mpa = 10 bar = 147 PSI)	
Varmtvannstemperatur	max. 80° C
Anbefalt temperatur for varmt vann	65° C
Gjennomstrømningsytelse:	ca. 58 l/min 0,3 MPa

Vedlikehold

Termostater trenger ikke noe spesielt vedlikehold. Funksjonen til returløpssperringen skal iht. DIN EN 1717 og i samsvar med de nasjonale og lokale forskrifter sjekkes regelmessig (DIN 1988 en gang i året). Ved denne anledningen skal du også sjekke smussfangere som finns på MTC regulerings-enheten (6.1). Etter montering av MTC regulerings-enheten (6) skal utløpstemperaturen absolutt sjekkes som beskrevet under punkt "Justeringer". Sjekk i hvert tilfelle at vannforsyningen er slått på og at den maksimale varmtvannstemperaturen ligger opp til tappestedet.

For å holde regulerings-enheten bevegelig, skal termostaten stilles fra tid til annen på helt varmt og helt kaldt.

Service deler se side 3

1	Termostatgrep	38391000
2	Rosett	96452000
3	Hylse	97439000
4	Holder skruer	96454000
5	Holderrosett	96447000
6	Reguleringsenhet for temperatur	96633000
7	Smussfiltersil	97367000
8	Returløpssperre	96655000
9	Forlengelse 25 mm	13595000
10	Forlengelse 25 mm	13596000

Norsk

Feil	Årsak	Feilrettelse
Lite vann	-Forsyningstrykk er ikke tilstrekkelig -Smussfangersil til reguleringsheheten skitten. -Dusjens silpakning er skitten	-Ledningstrykk sjekkes -Smussfangersil rengjøres -Silpakning mellom dusj og slangen rengjøres
Kryssstrømning, varmt vann presses ved lukket armatur inn i kaldtvannsledning eller omvendt	-Returløpstopper skitten / defekt	-Returløpstopper byttes
Utløpstemperatur samsvarer ikke med innstilt temperatur	-Termostat ble ikke justert -For lav varmtvannstemperatur	-Termostat justeres -Varmtvannstemperatur økes til mellom 42 C og 65 C
Temperaturregulering er ikke mulig	-Reguleringsenhet for temperatur er skitten eller forkalket -Funksjonsblokk bygges inn 180 forvregt	-Ved nyinstallasjon: baseelement feilaktig tilkoblet (riktig: kaldt høyre, varmt venstre) eller bygd inn 180 forvregt -Trykknapp til sikkerhetssperren uten funksjon
Fjær defekt	-Fjær hhv. Trykknapp rengjøres og smøres lett inn, byttes hvis nødvendig -Kalk på trykknapp	-Fjær hhv. Trykknapp rengjøres og smøres lett inn, byttes hvis nødvendig -Fjær hhv. Trykknapp rengjøres og smøres lett inn, byttes hvis nødvendig

Prøvemerket

	P-IX	DVGW	SVGW	WRSA	KIWA	ACS	NF
27070000						X	
27418XXX							
28420000						X	
28435XXX						X	

Rengjøring

Simpelten ren: Ved å gnikke er det lett å fjerne kalk fra nuppene.

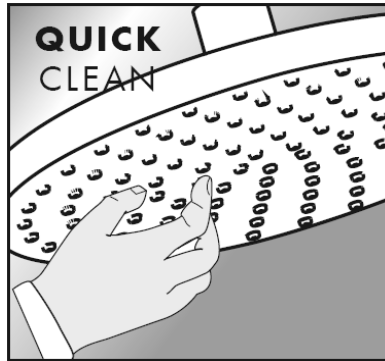

Stellveiledning

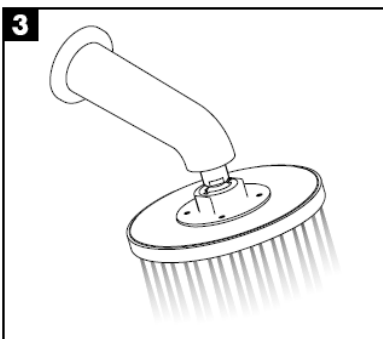
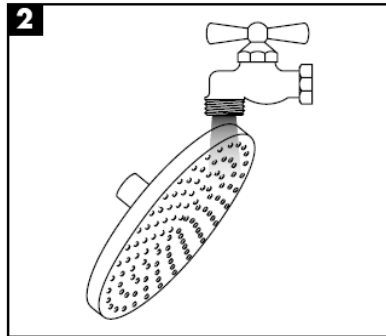
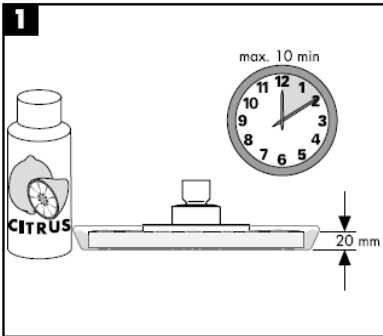

hansgrohe

РЪКОВОДСТВО ЗА МОНТАЖ



27418XXX

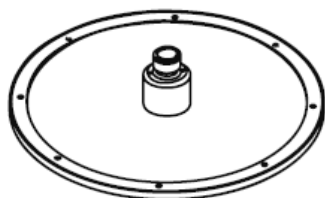

Raindance Royale AIR
28420000

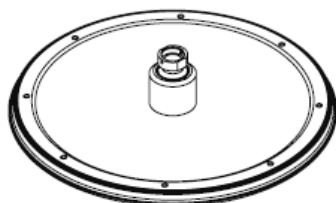

Raindance Royale Classic AIR
28435XXX

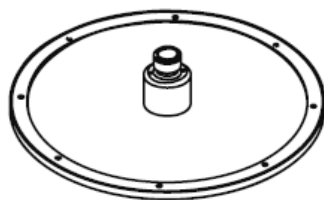

**Raindance Royale
High Flow Set**
27070000

hangrohe

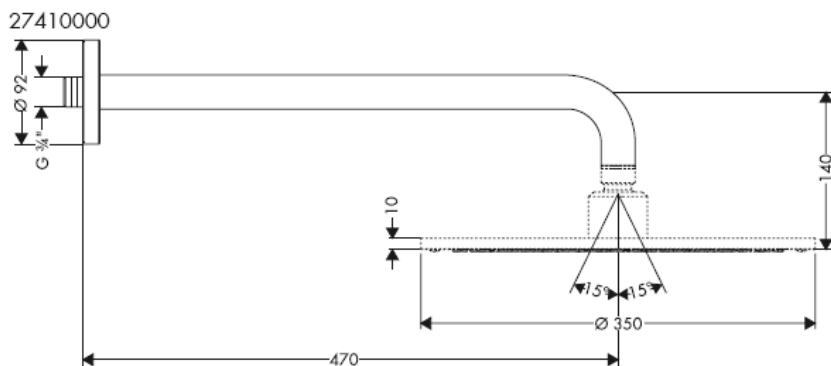
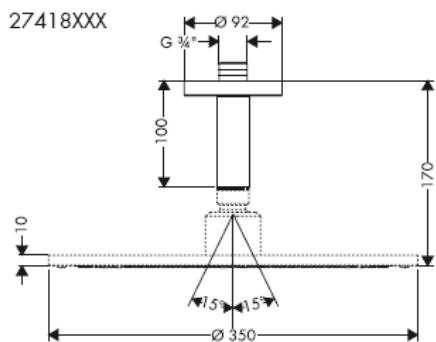
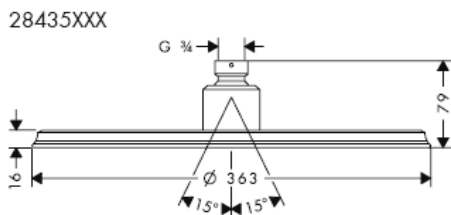
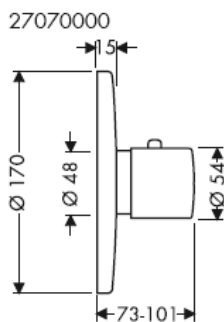
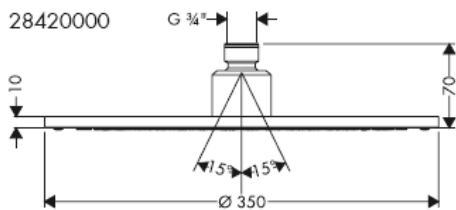

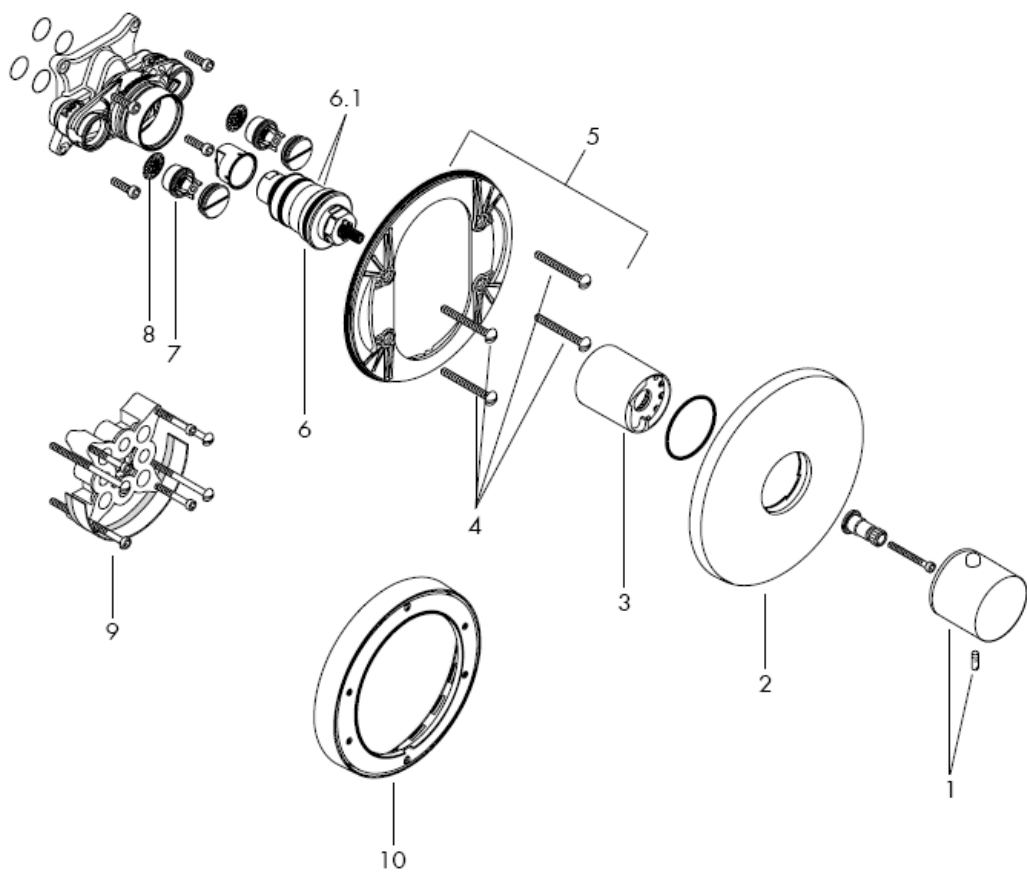

Изравнете по възможност към растера на плочките.

За закрепване на рамото на разпръсквателя е необходимо подсилване на стената.

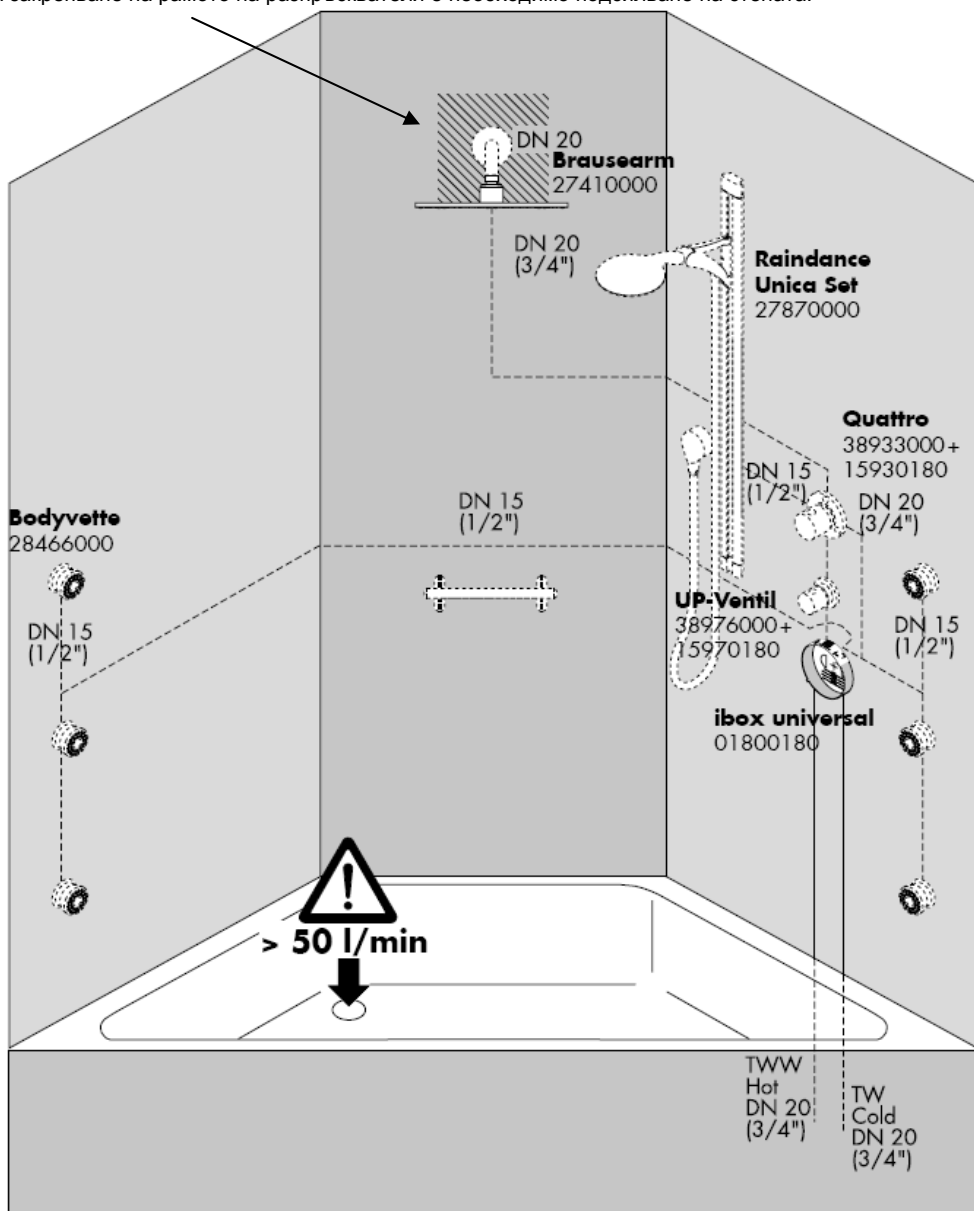

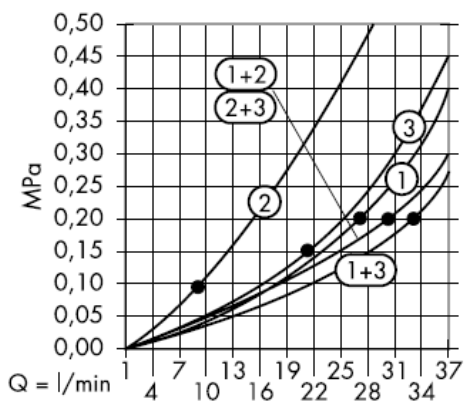

От • функцията е гарантирана.

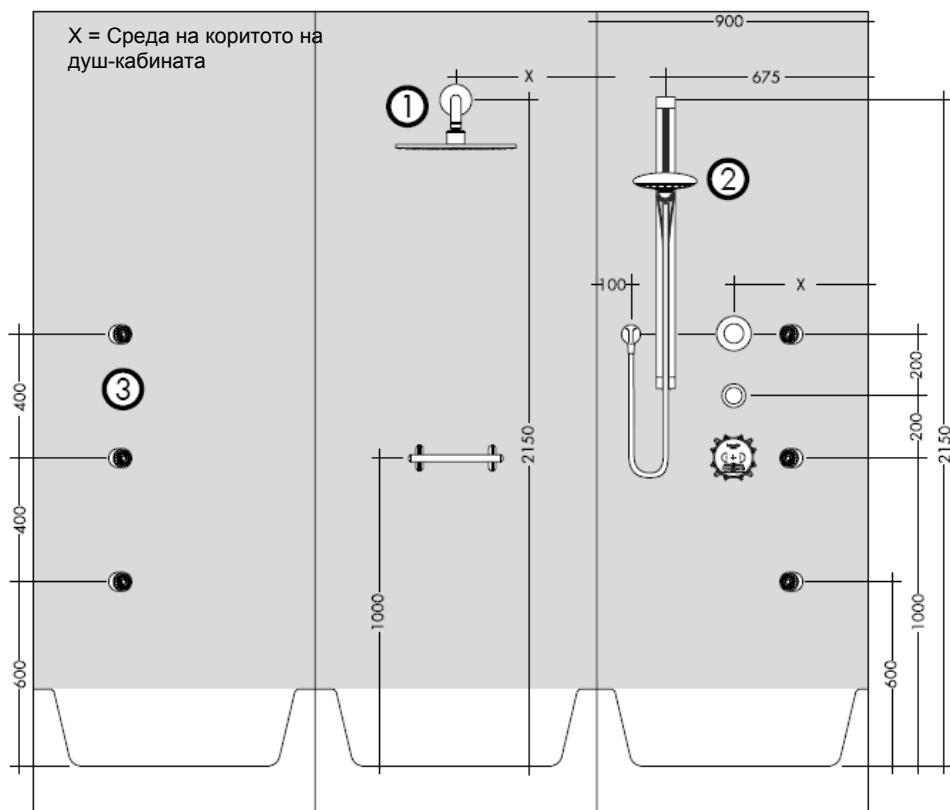

За закрепване на рамото на разпръсквателя е необходимо подсилване на стената.

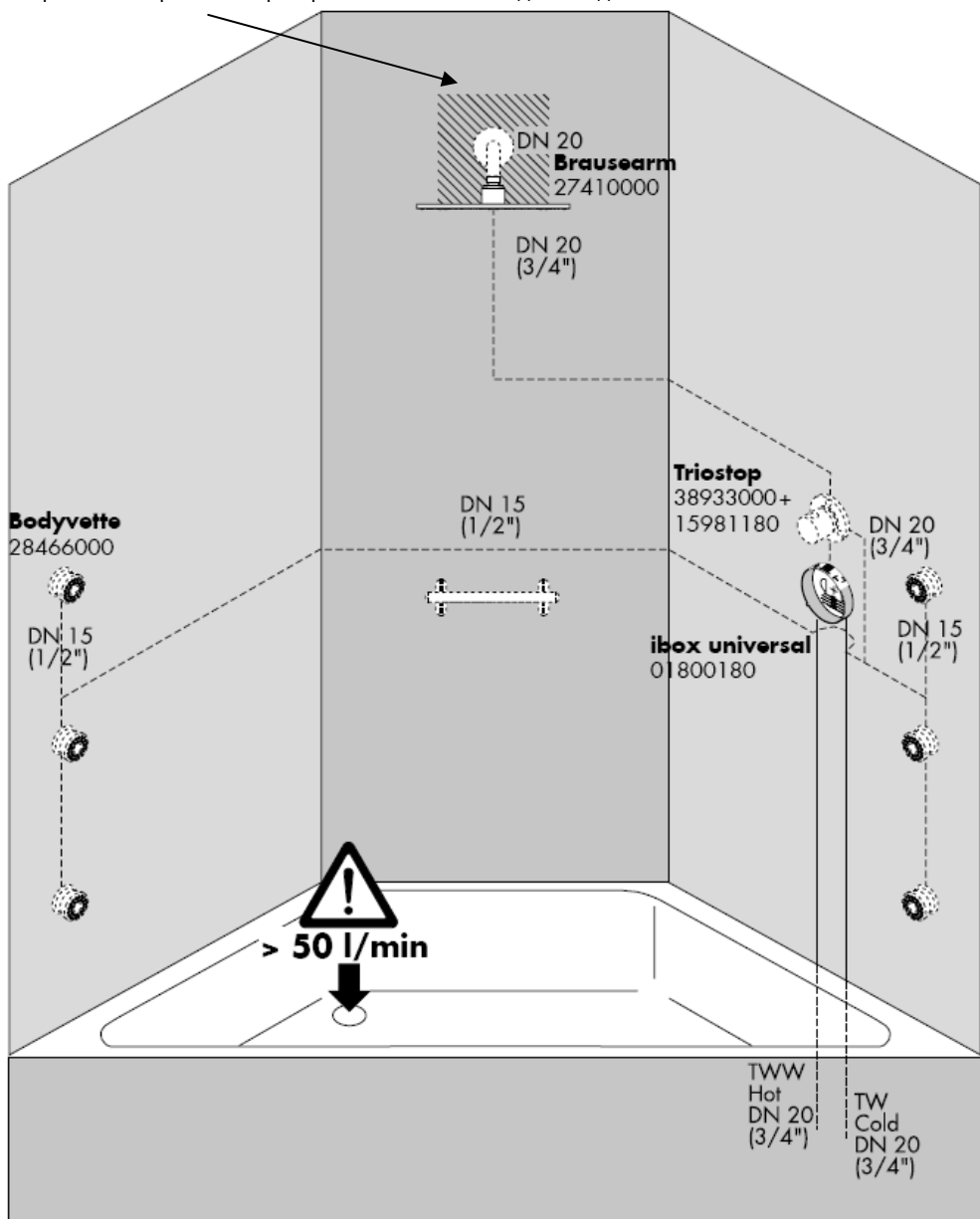

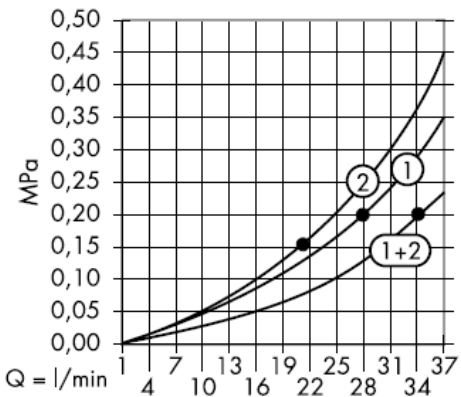

От • функцията е гарантирана.

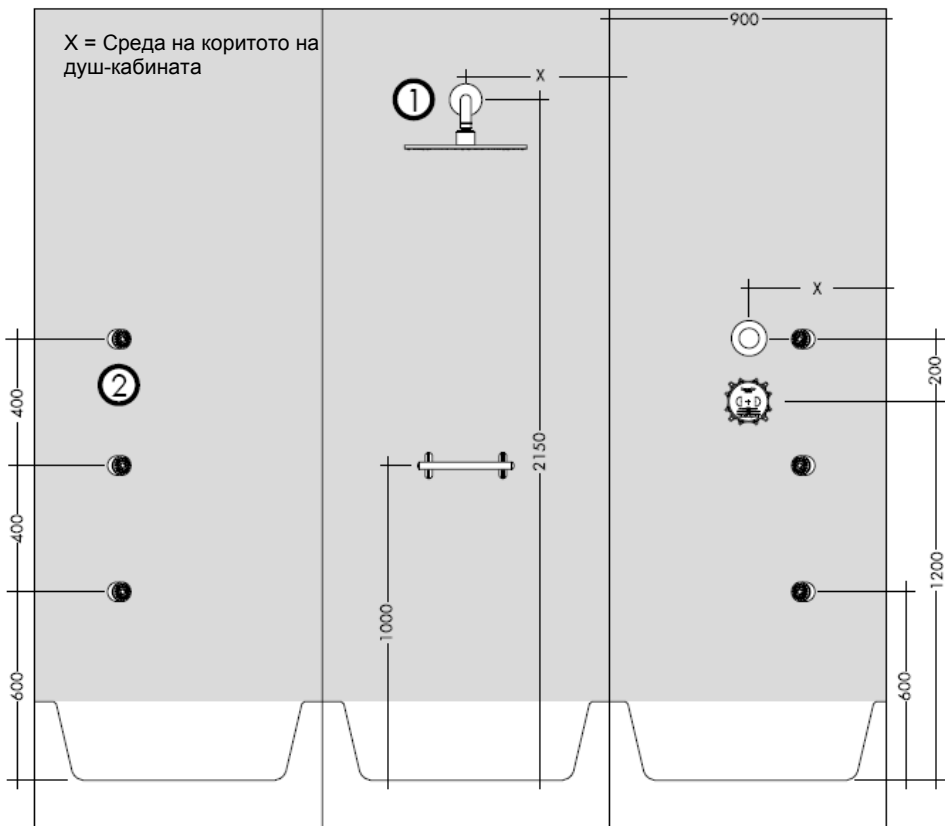

За закрепване на рамото на разпръсквателя е необходимо подсилване на стената.

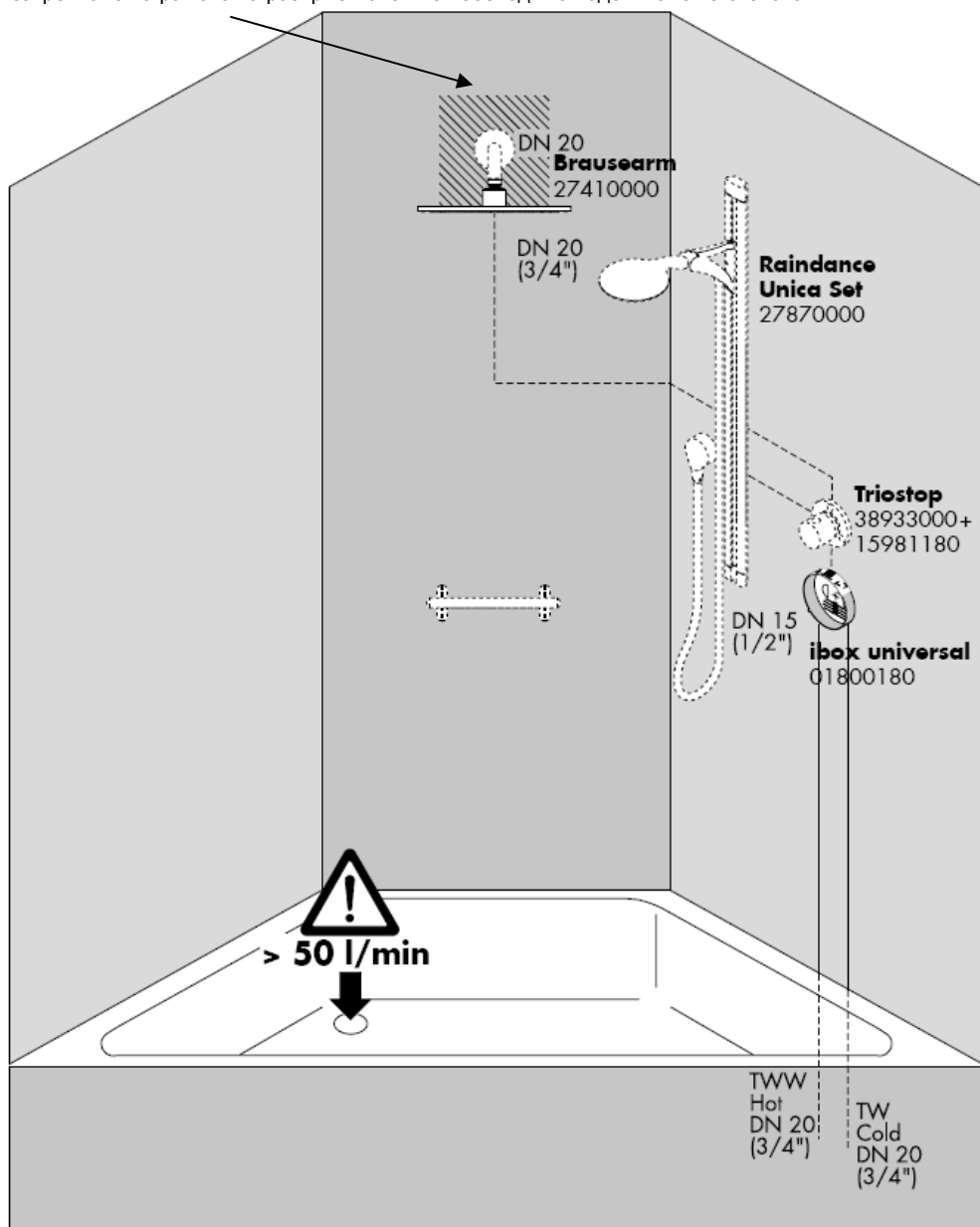

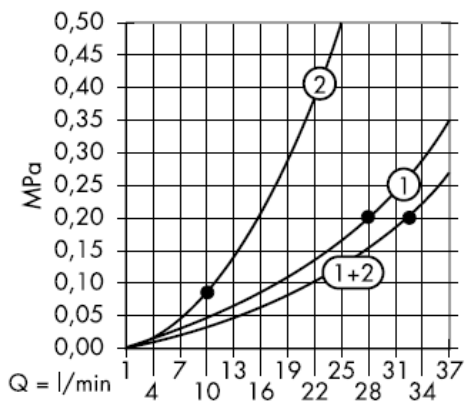

От • функцията е гарантирана.

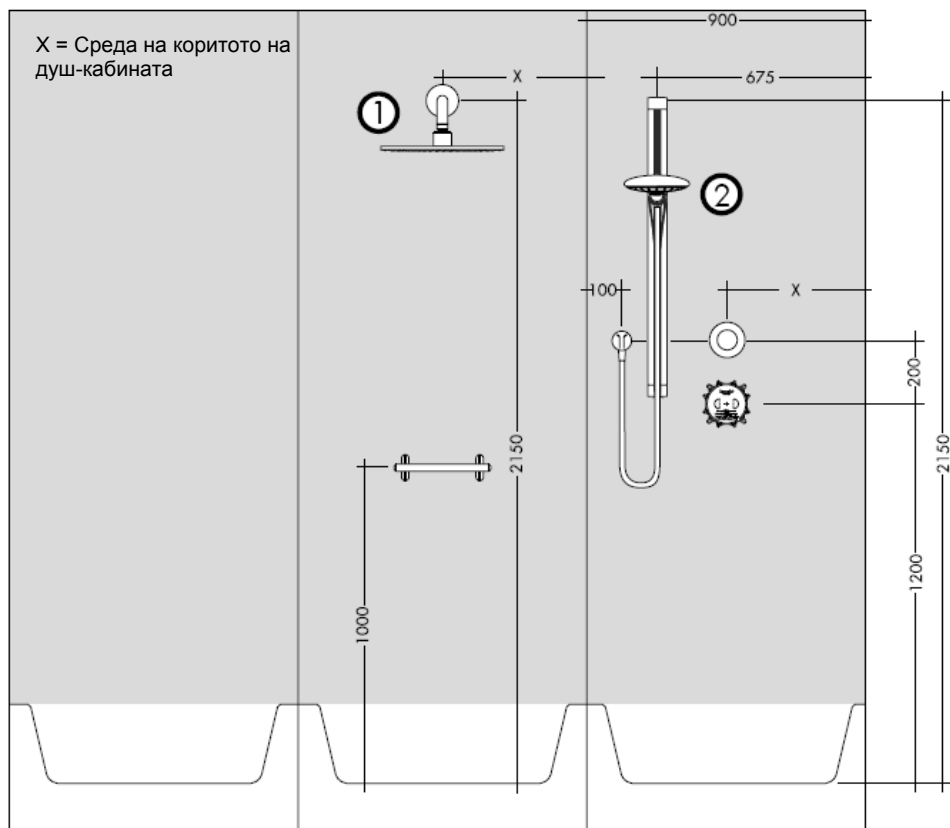

За закрепване на рамото на разпръсквателя е необходимо подсилване на стената.

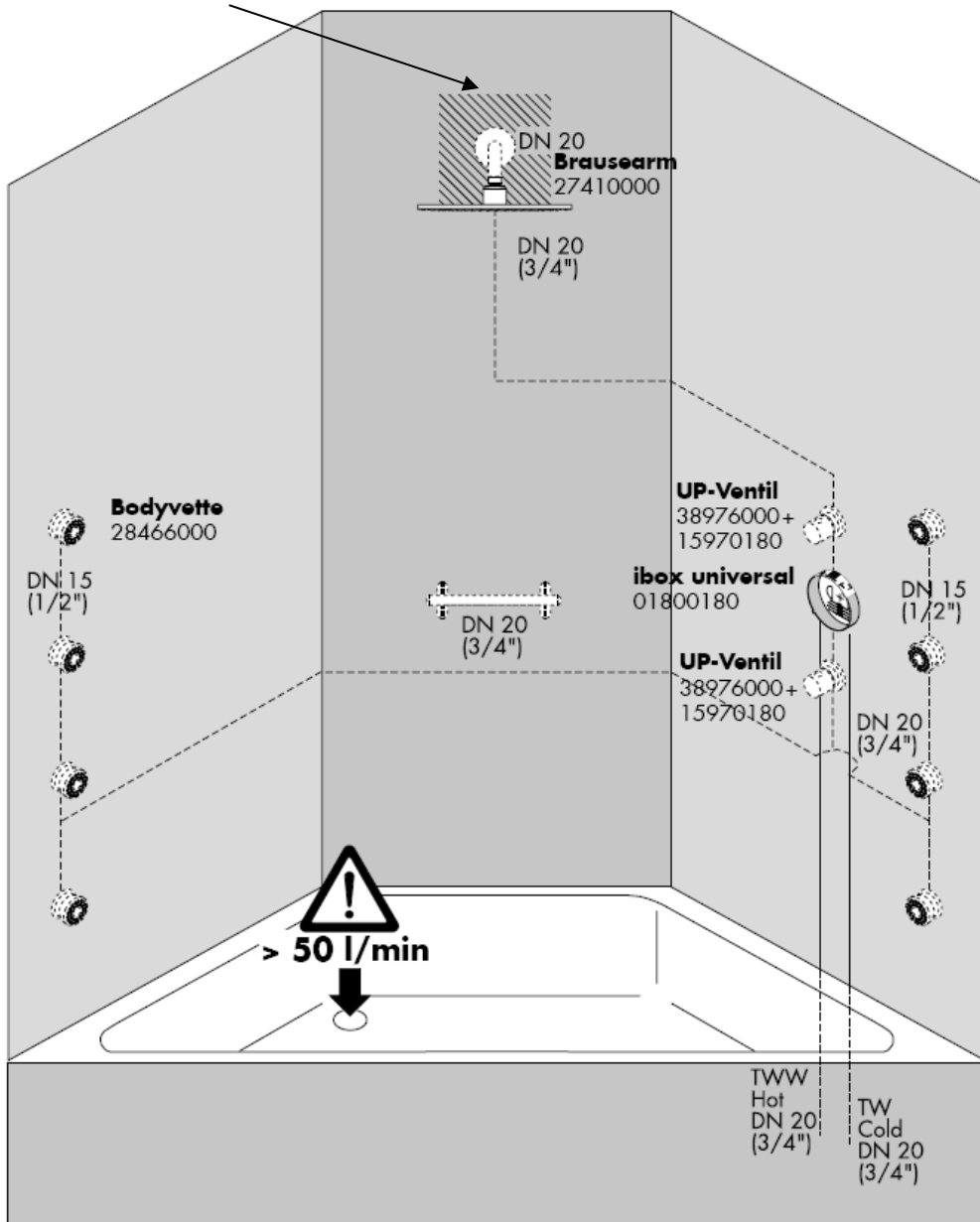

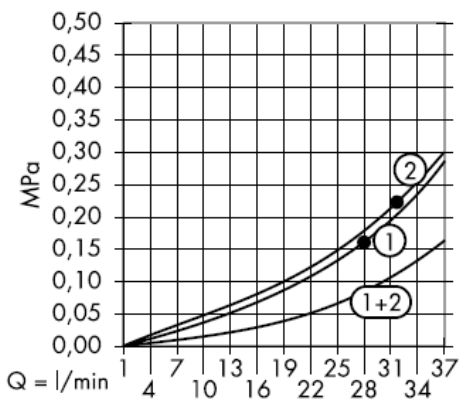

От • функцията е гарантирана.

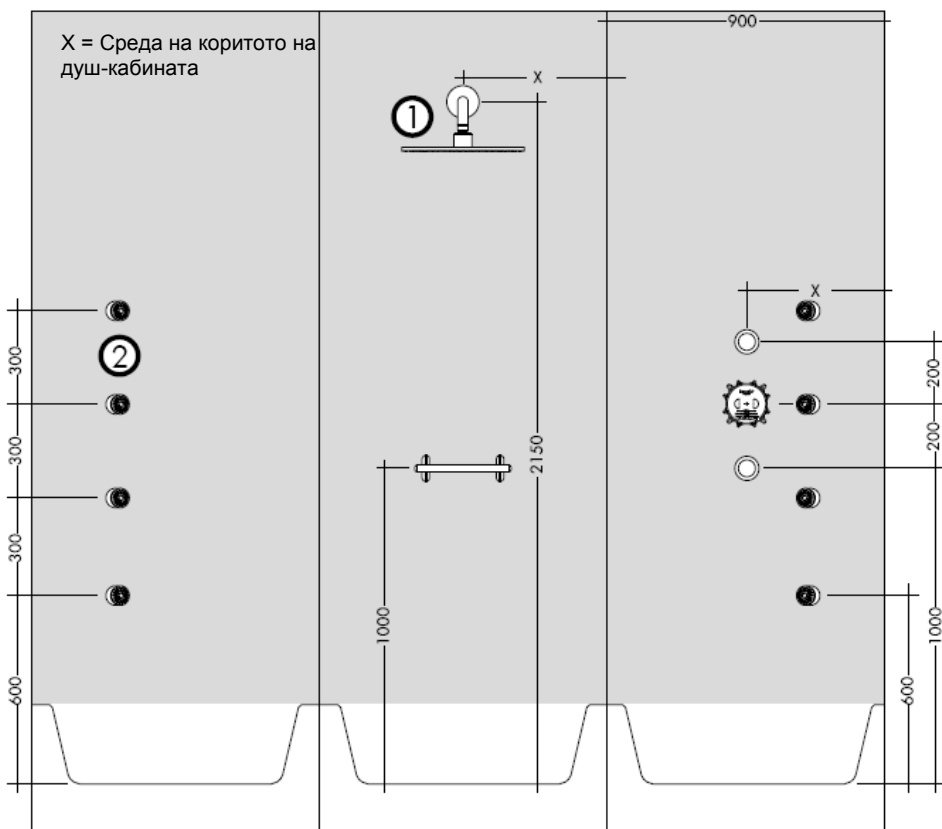

За закрепване на рамото на разпръсквателя е необходимо подсилване на стената.

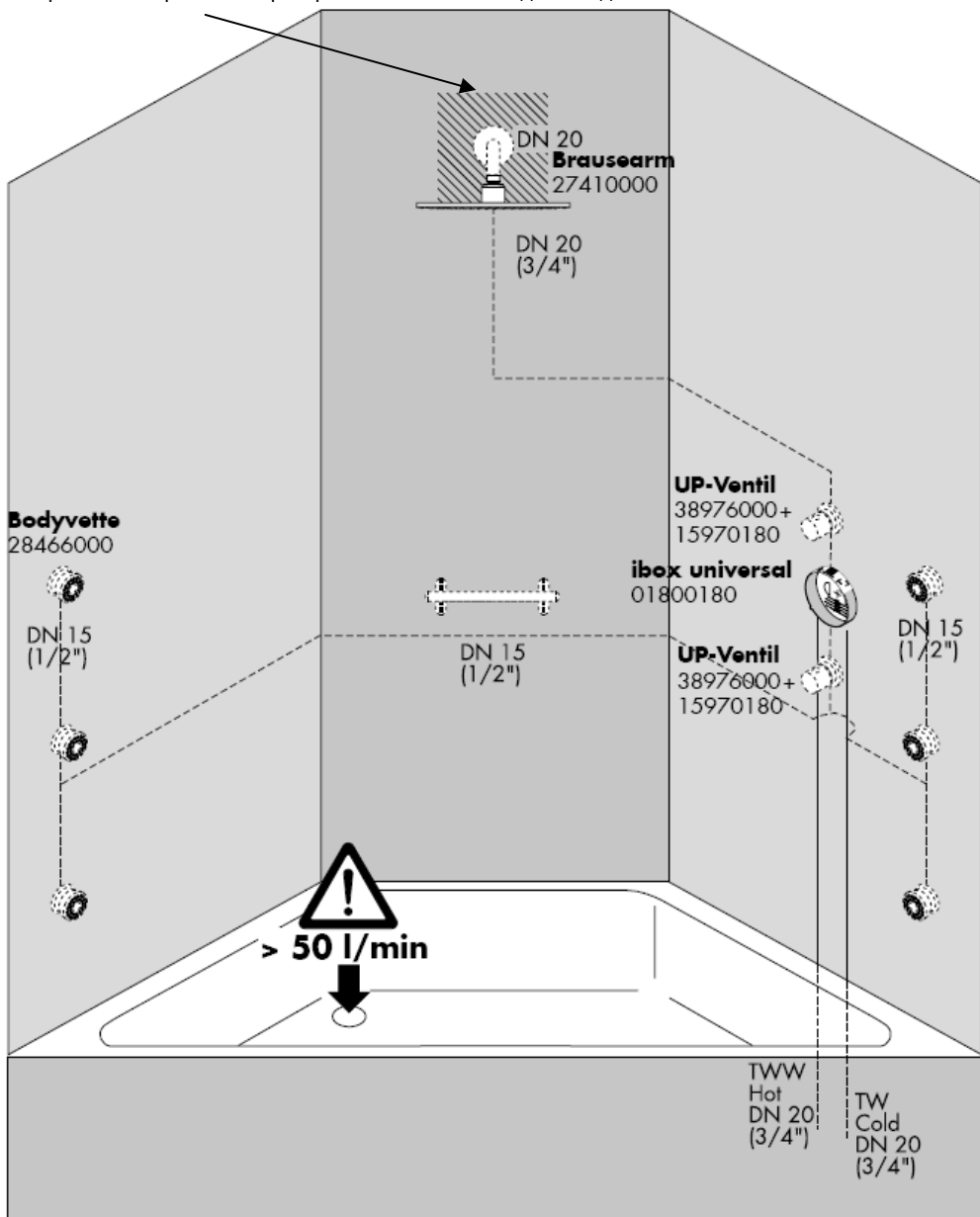

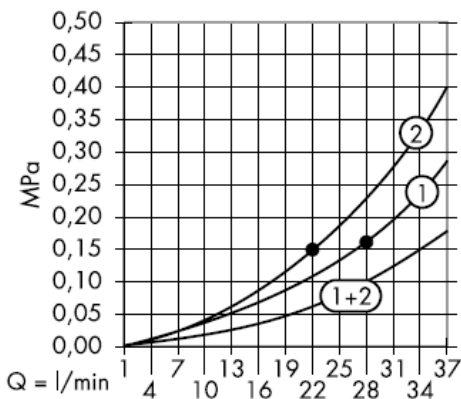

От • функцията е гарантирана.

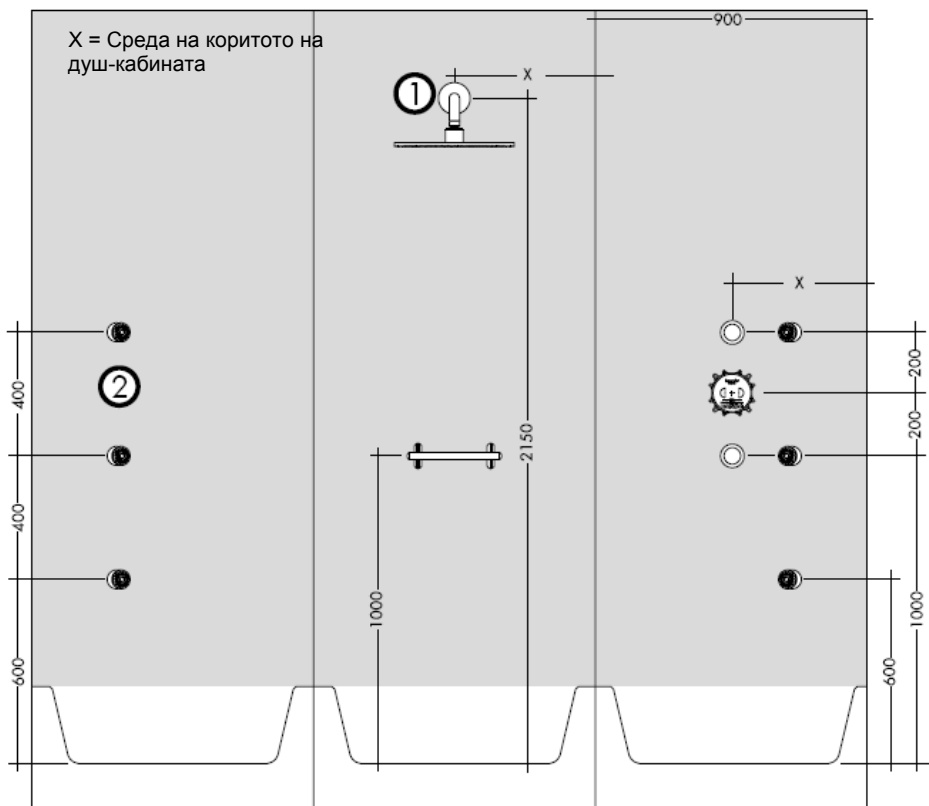

За закрепване на рамото на разпръсквателя е необходимо подсилване на стената.

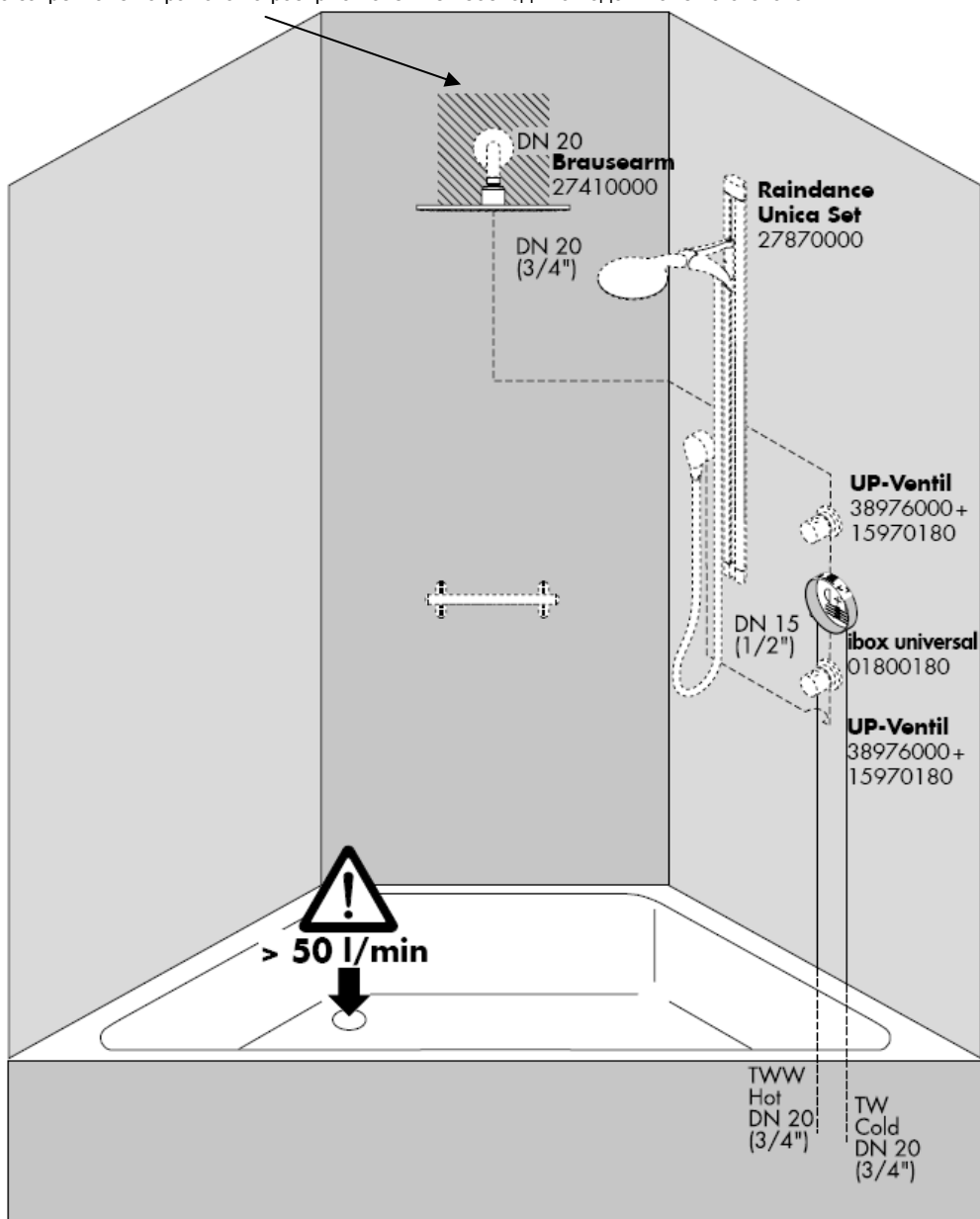

От • функцията е гарантирана.

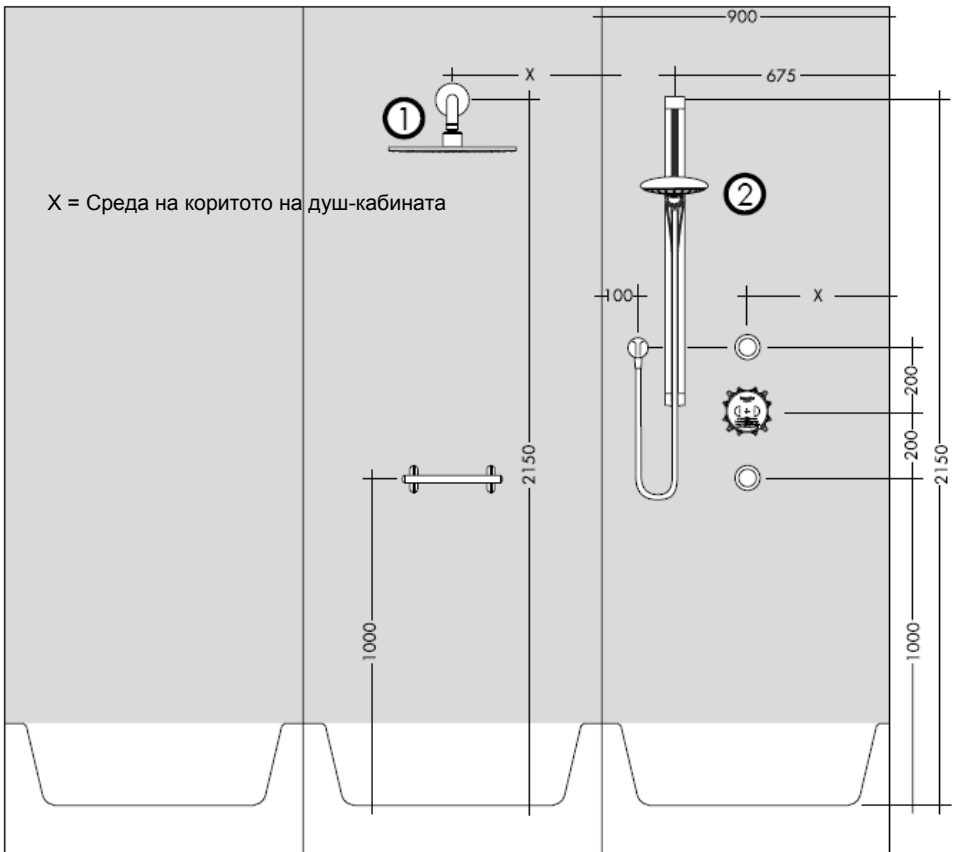
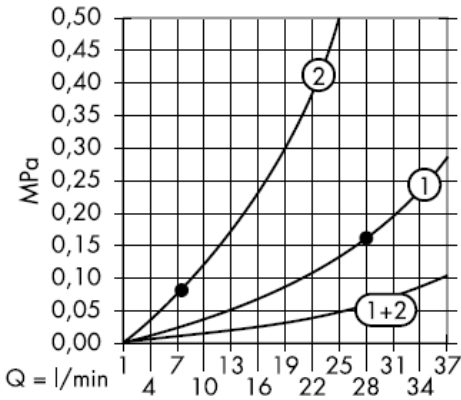

За закрепване на рамото на разпръсквателя е необходимо подсилване на стената.

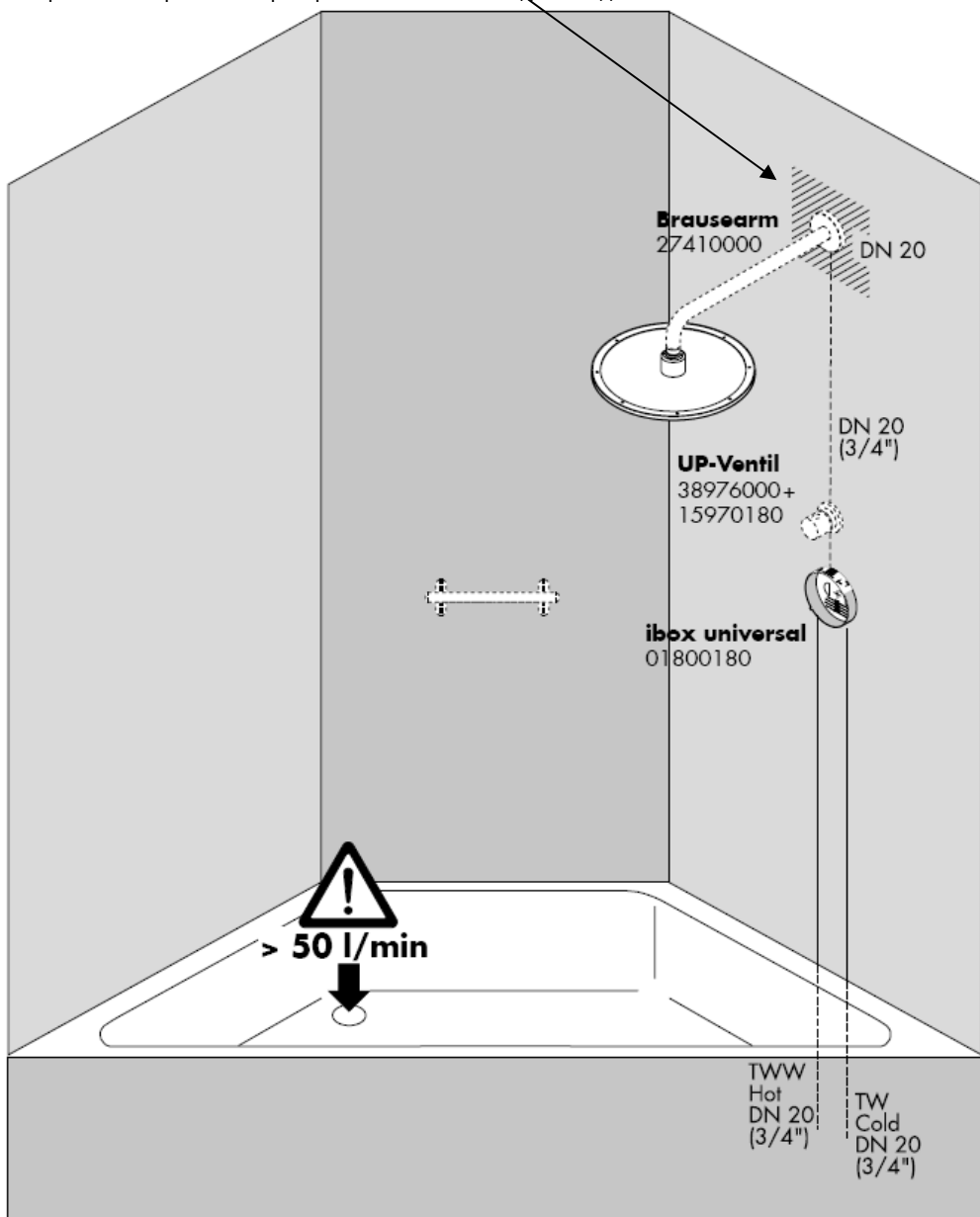

От • функцията е гарантирана.

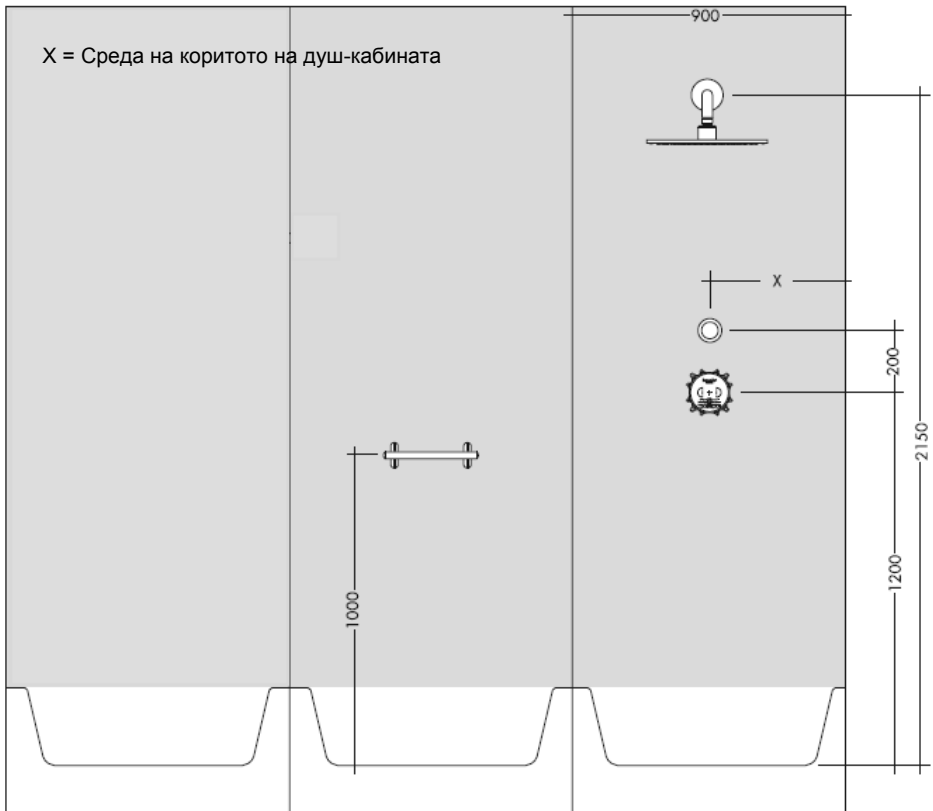
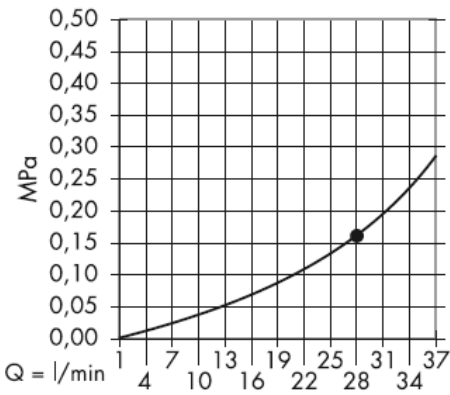

За закрепване на рамото на разпръсквателя е необходимо подсилване на стената.

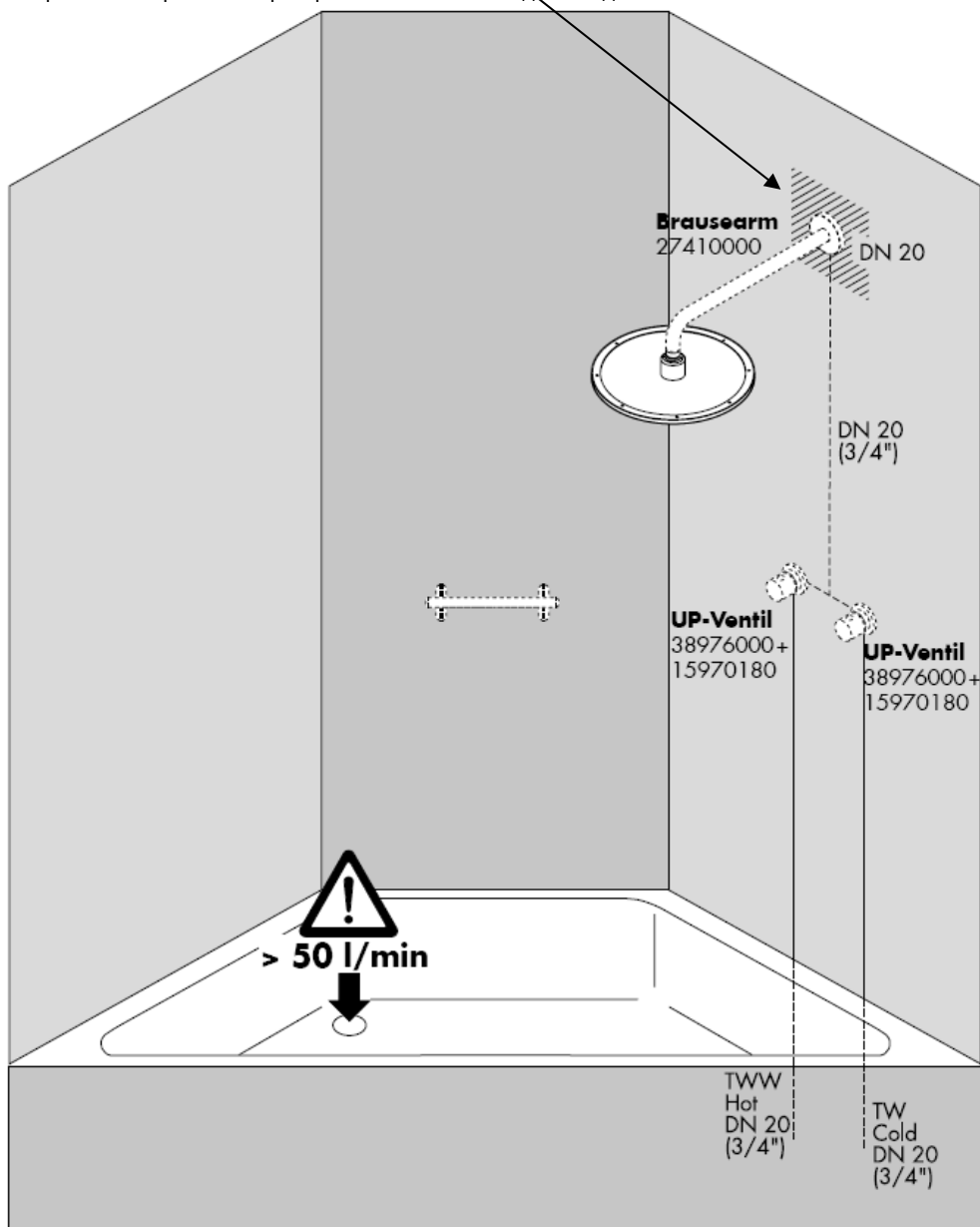

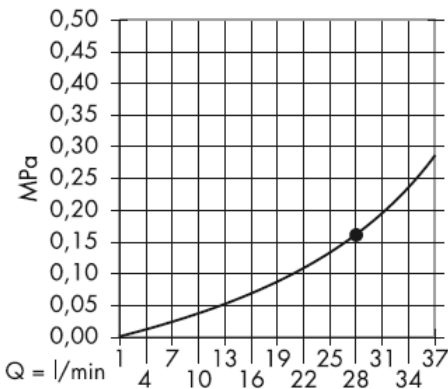

От • функцията е гарантирана.

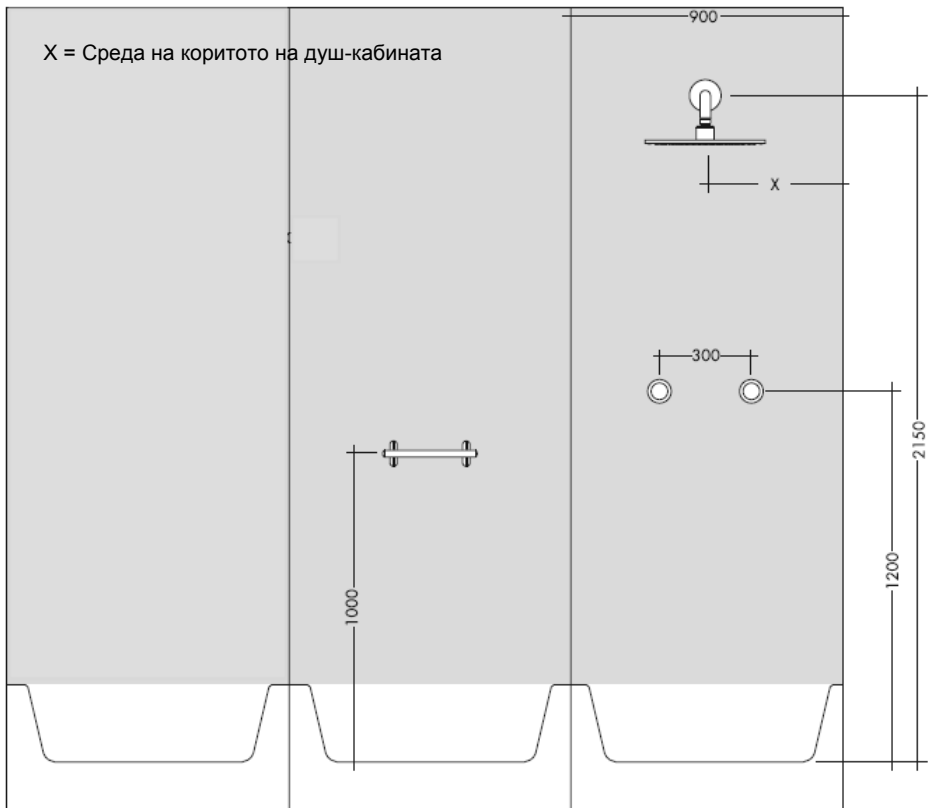

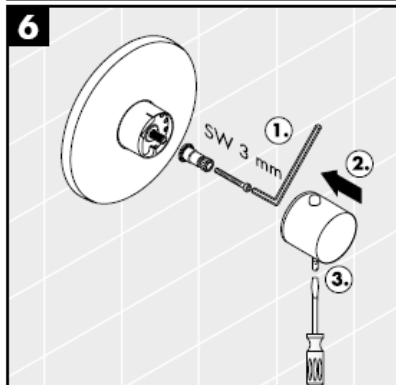
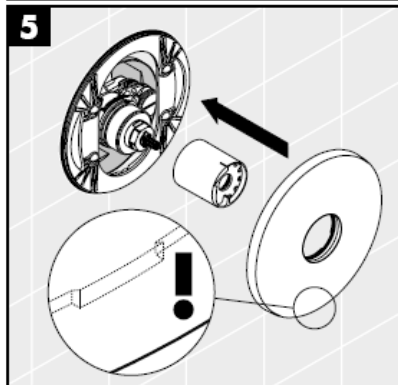
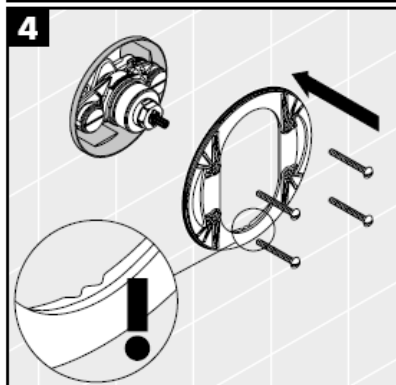
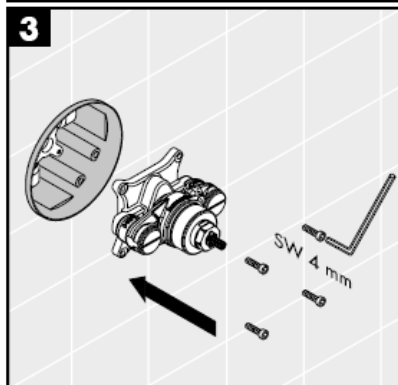
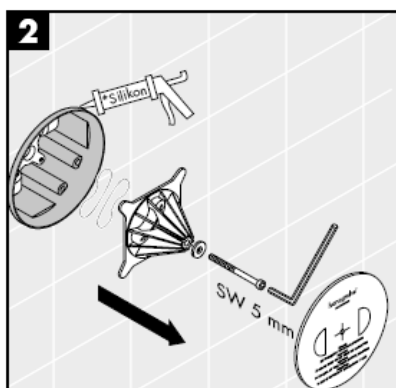
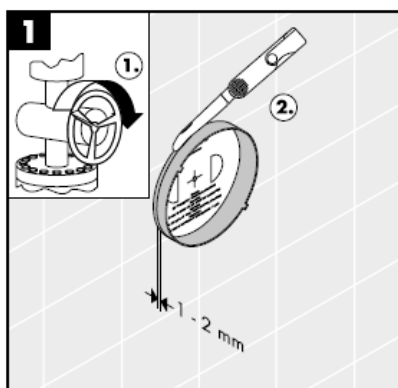

Силикон (без оцетна киселина!)

Благодарение на Safety Function (функция за безопасност) желаната максимална температура може да се настрои предварително напр. на макс. 42 C.

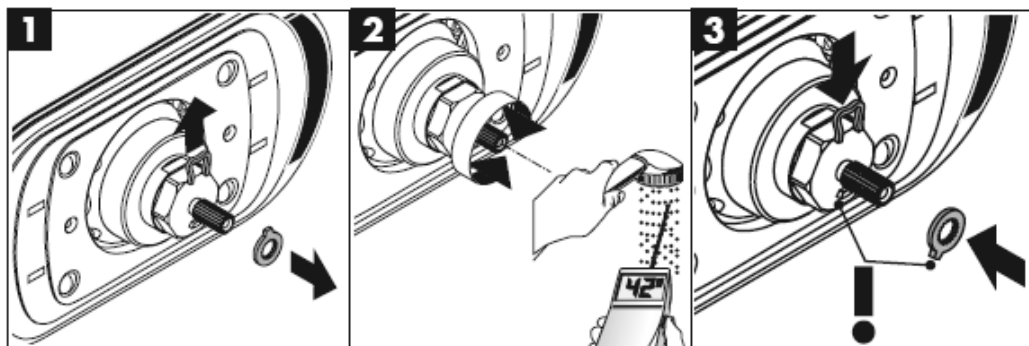

Юстиране

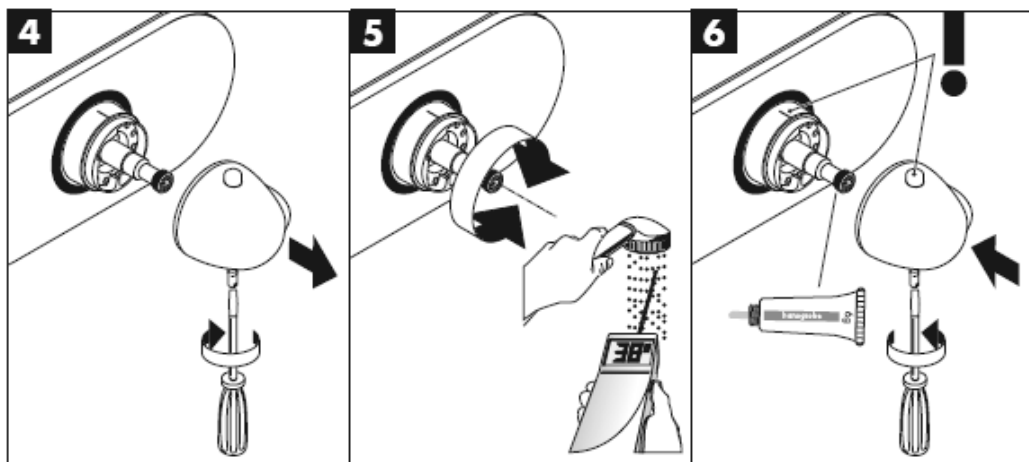



Когато разпръсквателят функционира, той заедно с рамото на разпръсквателя има тегло от припл. 10 кг. Поради това е позволено единствено използване на подходящи за мазилки материали за закрепване! Приложените винтове и дюбели са само за масивна зидария.

Позволено е единствено използване на подходящи за мазилки материали за закрепване! Приложените винтове и дюбели са само за масивна зидария.

Трябва да се изчисли достатъчна мощност на изтичане.

Оптималното функциониране се гарантира само във връзка с термостати Hansgrohe High Flow.

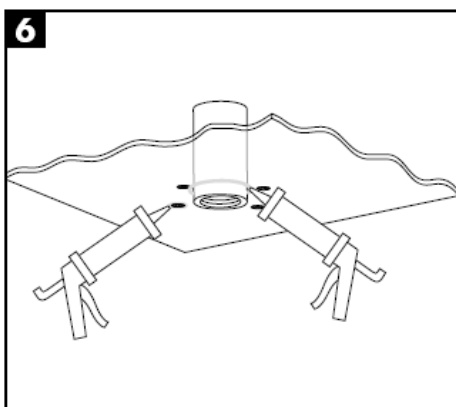
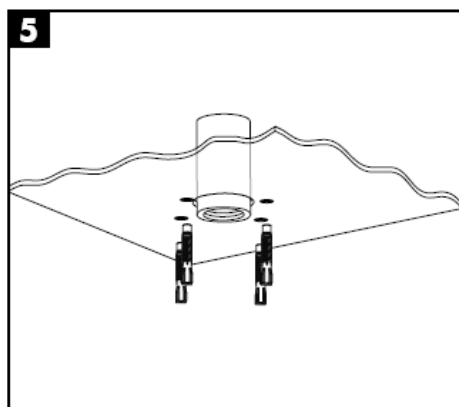
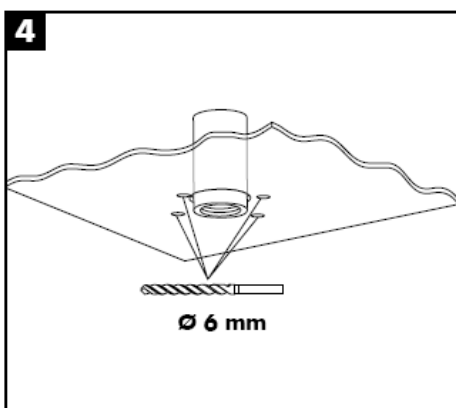
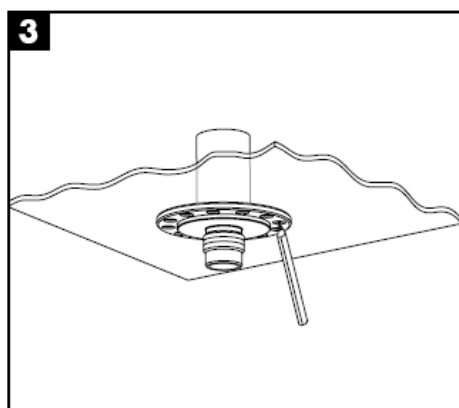
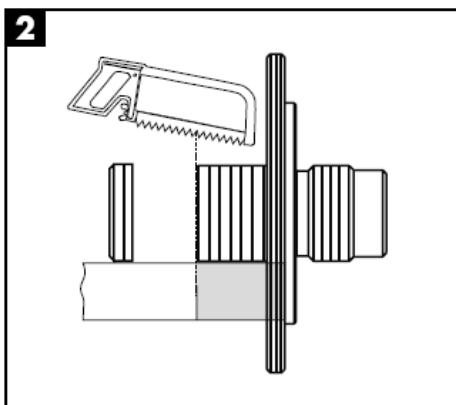
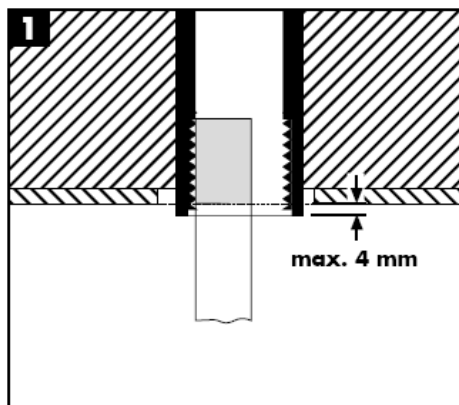

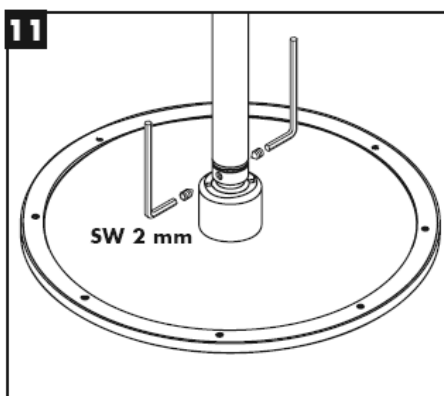
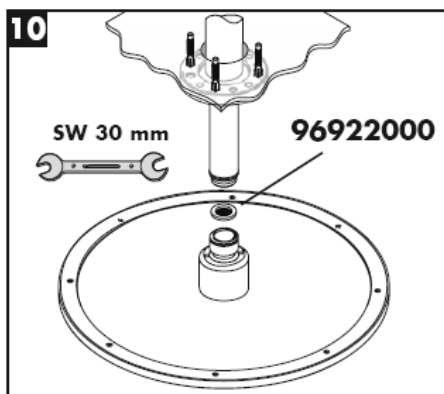
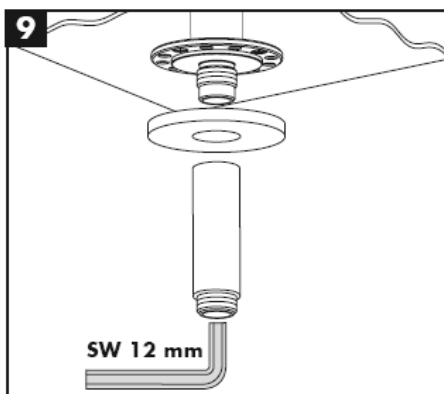
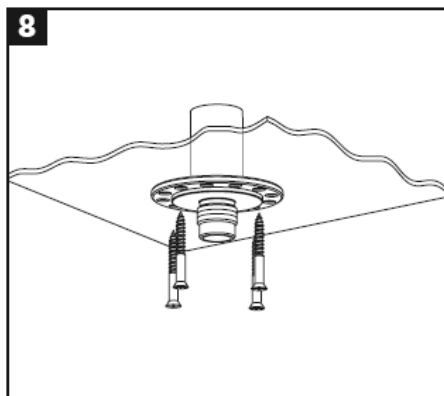
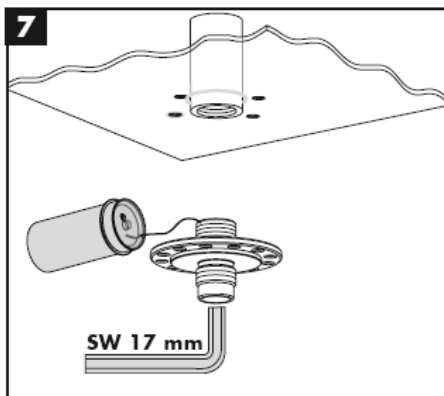

Опакованото заедно с разпръсквателя уплътнение с цедка трябва да се монтира, за да се избегне натрупване на замърсявания от водопроводната мрежа. Натрупването на замърсявания може да наруши функцията и/или да доведе до увреждания на функционалните части на разпръсквателя, Hansgrohe не носи отговорност за получените се по този начин щети.

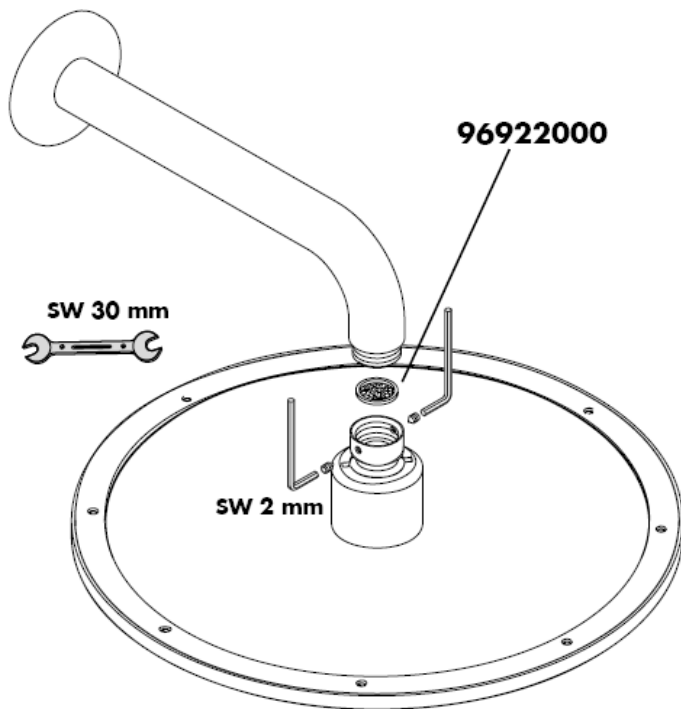

Монтаж

Внимание! Арматурата трябва да се монтира, промие и провери в съответствие с валидните норми!

Юстиране

Ако измерената температура на мястото на водовземане се различава от настроената на термостата температура, е необходима корекция. При това да се има пред вид следното: Завъртете ръкохватката със скала, докато на мястото на водовземане изтече вода с 38 °С. Развийте винта на ръкохватката, издърпайте назад ръкохватката и я завъртете до положението 38 °С. Поставете ръкохватката и затегнете винта на ръкохватката (вижте стр. 22).

Ограничение на температурата

Температурният диапазон се ограничава до 38 °С с помощта на обезопасителна бариера (защита от попарване). Ако желаете по-висока температура, бариерата от 38 °С може да се надвиши с натискане на копчето за обезопасяване.

Safety Function (Функция за безопасност)

Благодарение на Safety Function (функция за безопасност) желаната максимална температура може да се настрои предварително напр. на макс. 42 °С. вижте стр. 21.

Технически данни

Работно налягане: max. 1 MPa
 Работно налягане: 0,1 – 0,5 MPa
 Контролно налягане: 1,6 MPa
 (1 MPa = 10 bar = 147 PSI)
 Температура на горещата вода: max. 80° C
 Препоръчителна температура на горещата вода: 65° C
 Мощност на потока: ca. 5.8 l/min, 0,3 MPa

Поддръжка

Термостатите не се нуждаят от специална поддръжка Съгласно DIN EN 1717 редовно трябва да се проверява функционирането на приспособленията за предотвратяване на обратния поток в съответствие с националните или регионални изисквания (DIN 1988 веднъж годишно). При тази възможност проверявайте и уловителите на мръсотия, които се намират на регулиращия елемент МТС (6.1). След монтажа на регулиращото звено МТС (6) непременно проверете температурата на изхода, както е описано в точка „Настройка“. Непременно проверете предварително, дали захранването с топла вода е включено и дали на мястото на източване е налична макс. температура на топлата вода.

За да се гарантира лекоподвижността на регулиращото звено, от време на време термостатът трябва да се поставя на максимално топло и на максимално студено.

Сервизни части вижте стр. 3

1	Ръкохватка на термостата	38391000
2	Розетка	96452000
3	Втулка	97439000
4	Носещи болтове	96454000
5	Носеща розетка	96447000
6	Регулиращ температурата елемент	96633000
7	Цедка за улавяне на замърсявания	97367000
8	Приспособление, предотвратяващо обратния поток	96655000
9	Удължител 25 мм	13595000
10	Удължител 25 мм	13596000

БЪЛГАРСКИ

Неизправност	Причина	Помощ
Малко вода	-Захранващото налягане не е достатъчно -Цедката за улавяне на замърсяванията на регулиращия елемент е замърсена -Замърсено е уплътнението с цедка на разпръсквателя	-Проверете налягането на тръбопровода -Почистване на цедката за улавяне на замърсяванията -Почистете уплътнението с цедка между разпръсквателя и маркуча
Кръстосване на потока, при затворена арматура топлата вода навлиза в линията на студената вода или обратно	-Замърсено / дефектно приспособление за предотвратяване на обратния поток	-Смяна на приспособлението за предотвратяване на обратния поток
Изходящата температура не съвпада с настроената температура	-Термостатът не е юстиран -Твърде ниска температура на водата	-Юстиране на термостата -Повишете ограничението за топлата вода на 42 C до 65 C
Не е възможно регулиране на температурата	-Приспособлението за регулиране на температурата е замърсено или покрито с варовик -Монтирайте функционалния блок със завъртане на 180	-При нова инсталация основното тяло е свързано погрешно (Зад.: студено отдясно, топло отляво или монтирайте със завъртане от 180 -Копчето на предпазната блокировка не функционира
Дефектна пружина	-Почистете пружината респ. копчето и ги смажете леко, при необх. ги сменете -Копчето е покрито с варовик	-Почистете пружината респ. копчето и ги смажете леко, при необх. ги сменете -Почистете пружината респ. копчето и ги смажете леко, при необх. ги сменете

Контролен знак

	P-IX	DVGW	SVGW	WRSA	KIWA	ACS	NF
27070000						X	
27418XXX							
28420000						X	
28435XXX						X	

Почистване

Просто чисто: Варовикът лесно може да се изтърси от удебеленията.

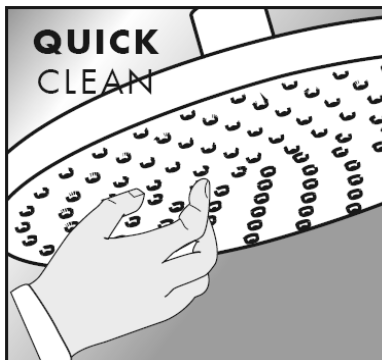

Инструкция за поддръжка

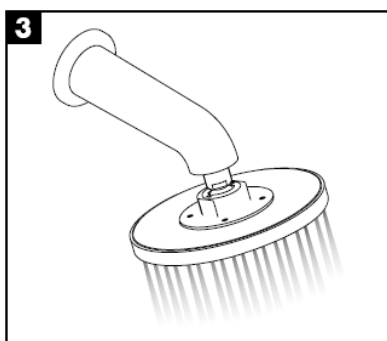
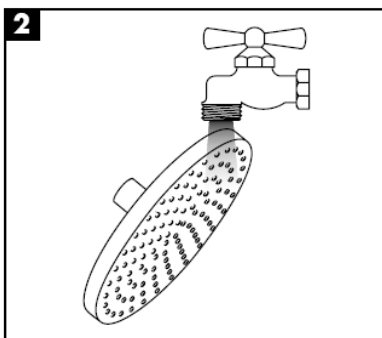
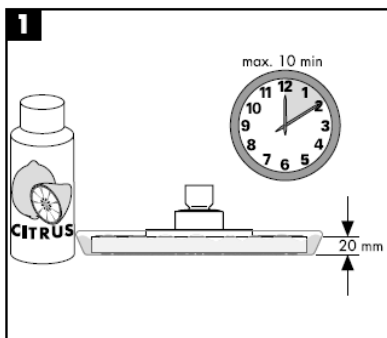

hansgrohe

Hansgrohe · Postfach 1145 · D-77761 Schiltach · Telefon +49 (0) 78 36/51-1282 · Telefax +49 (0) 7836/511440
E-Mail: info@hansgrohe.com · Internet: www.hansgrohe.com

07/2008
9.05170.04
БЪЛГАРСКИ

Udhëzime rreth montimit



27418XXX

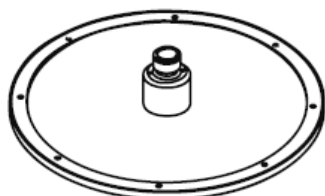

Raindance Royale AIR
28420000

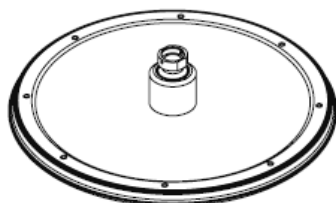

Raindance Royale Classic AIR
28435XXX

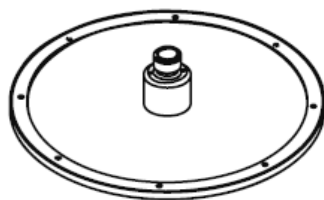

**Raindance Royale
High Flow Set**
27070000

hansgrohe

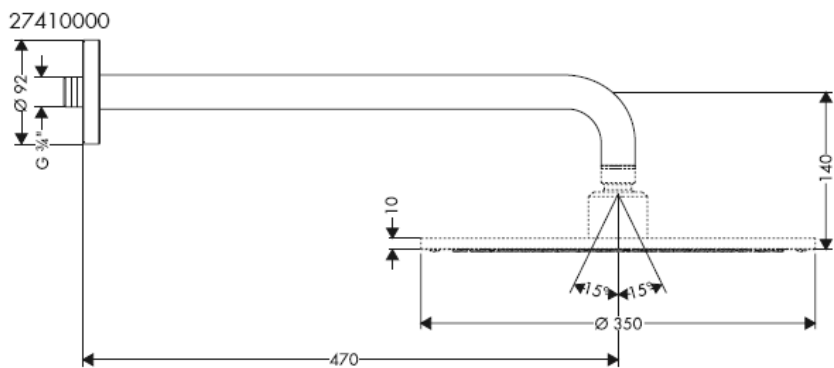
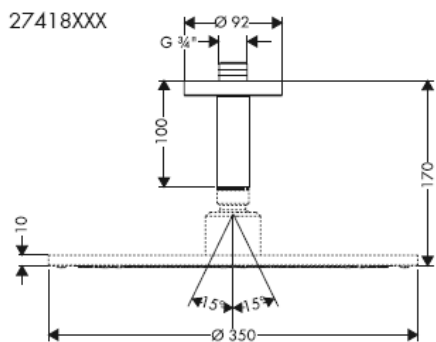
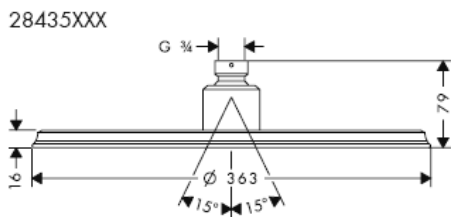
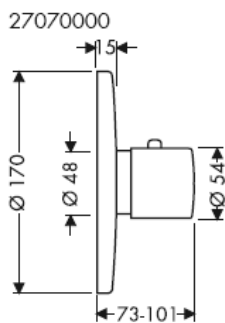
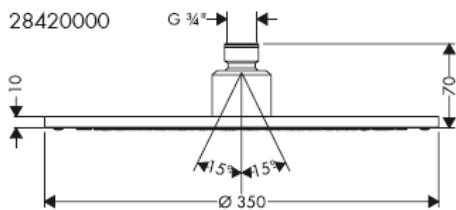

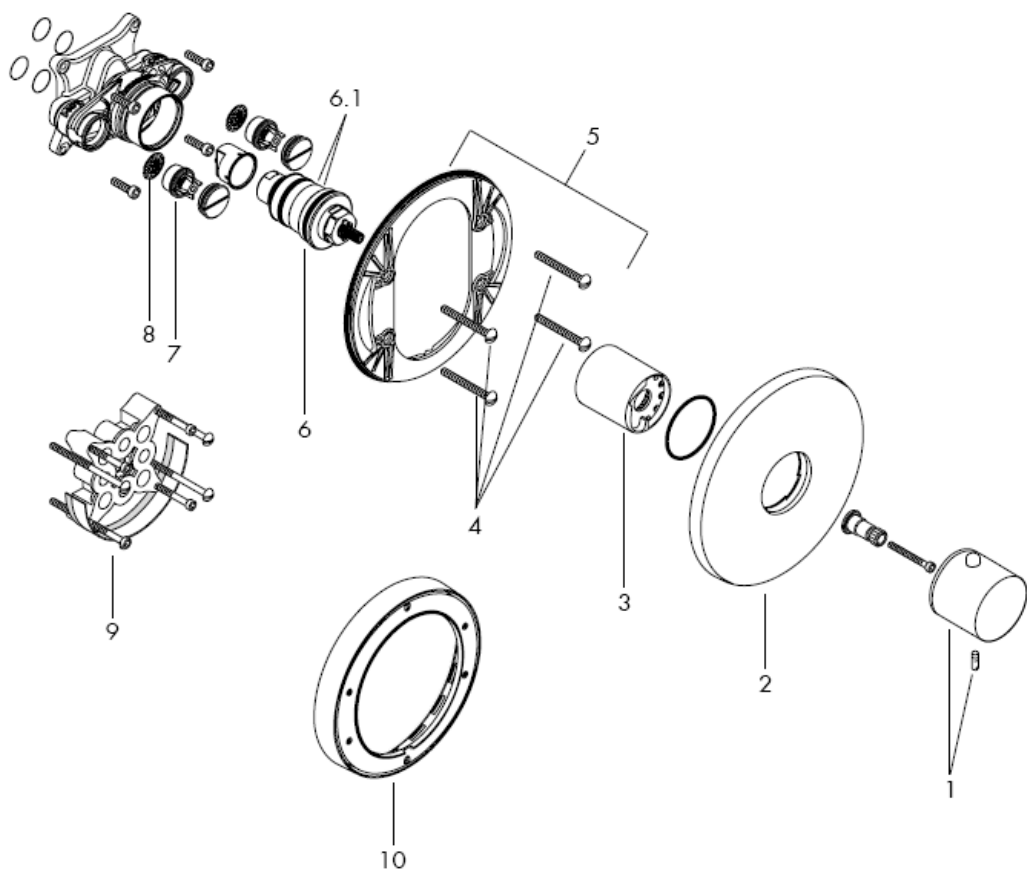

Përmasat i duhen përshtatur mundësisht këndit të pllakave të murit

Nevojitet përforcuesi për mur për mbërthimin e krahut të spërkatësit

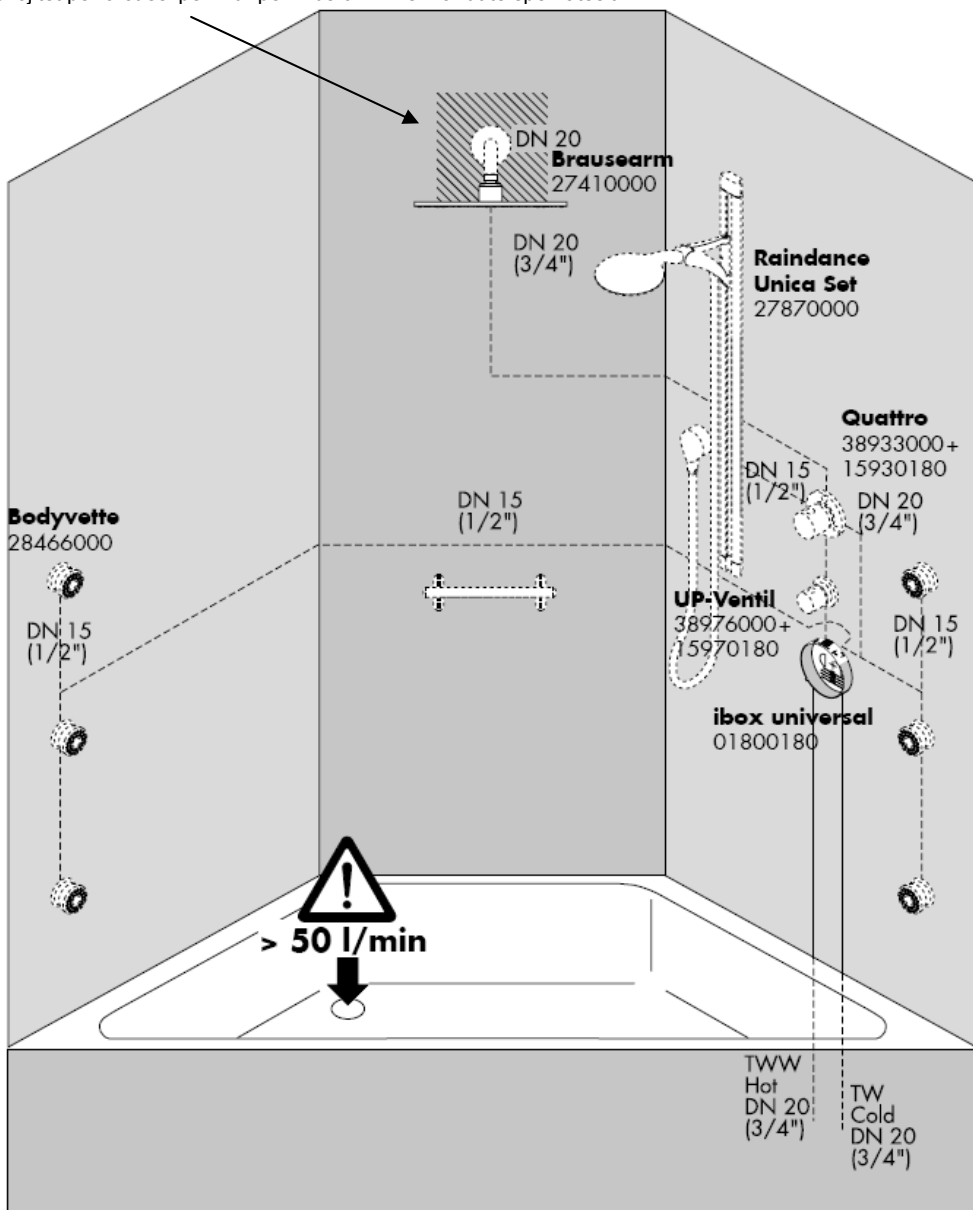

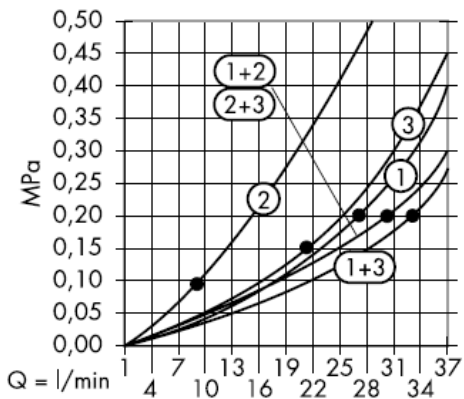

Nga • është i mundur funksioni.

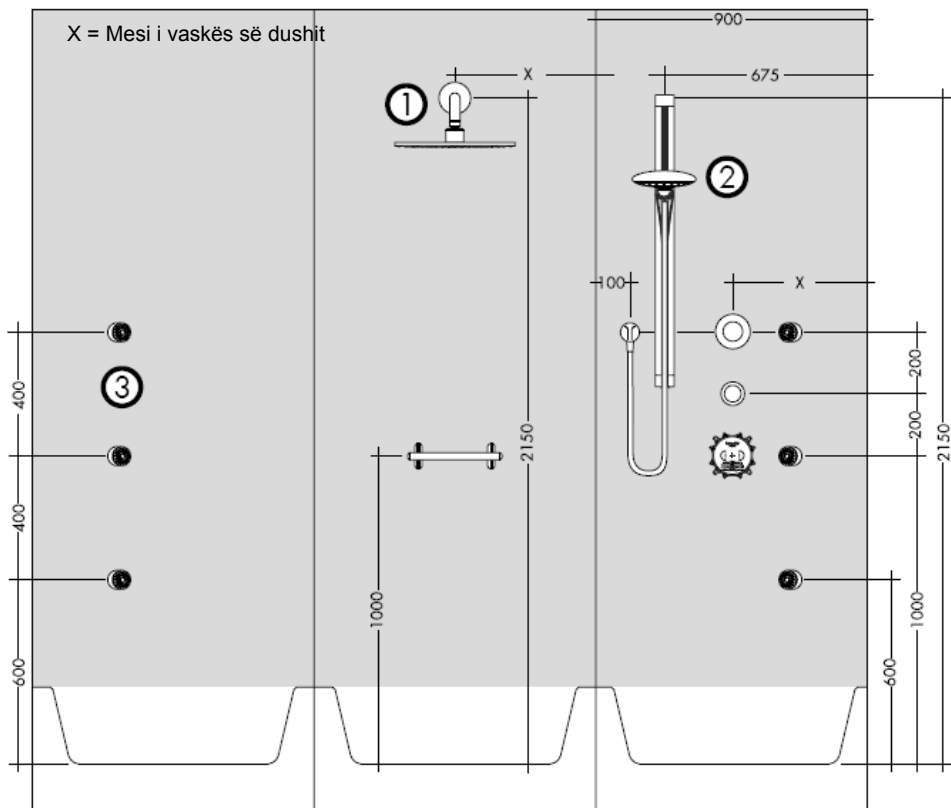

Nevojitet përforcuesi për mur për mbërthimin e krahut të spërkatësit

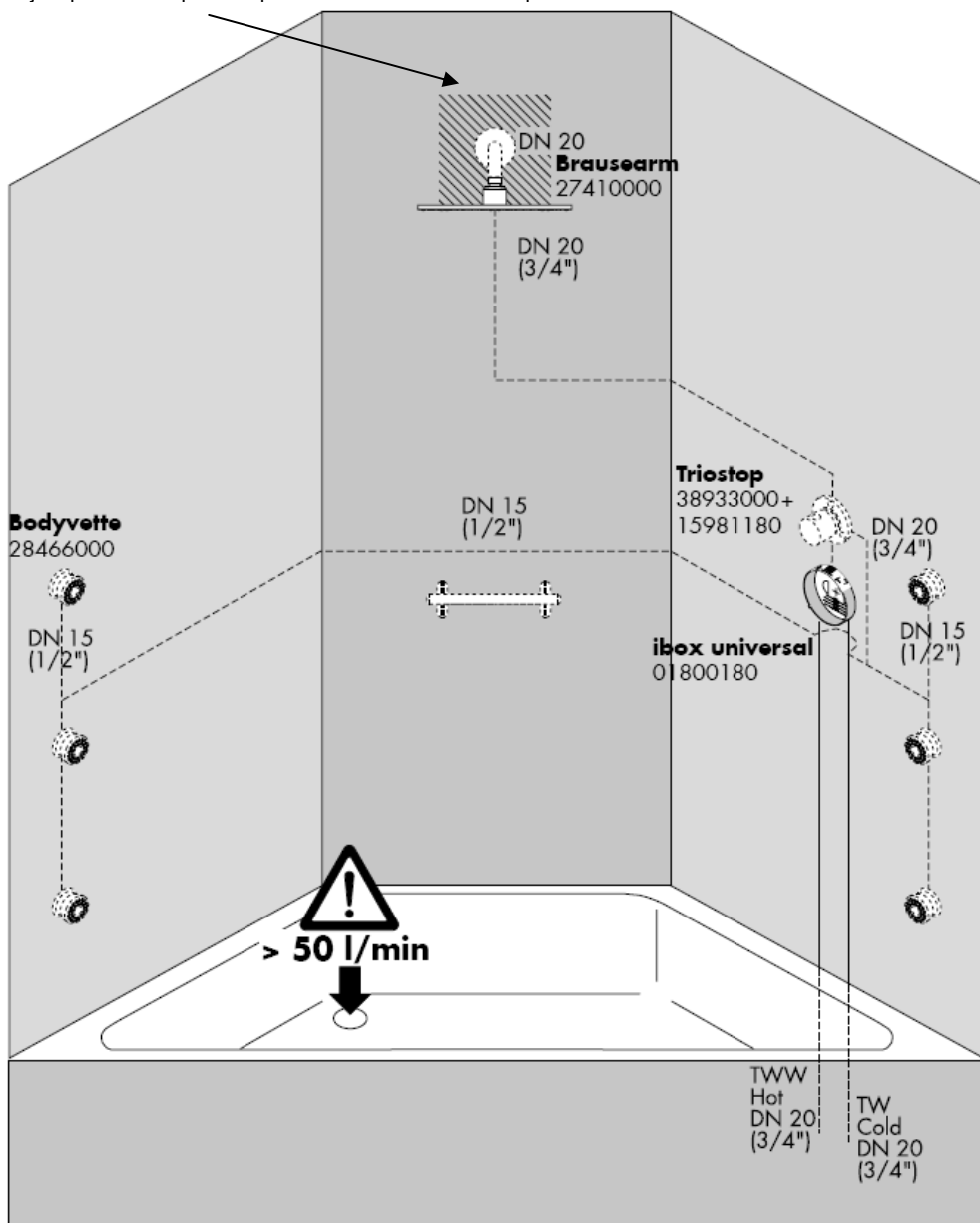

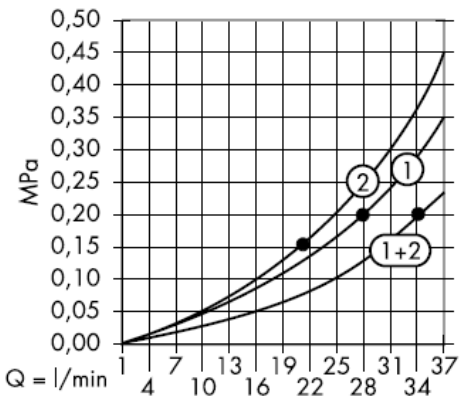

Nga • është i mundur funksioni.

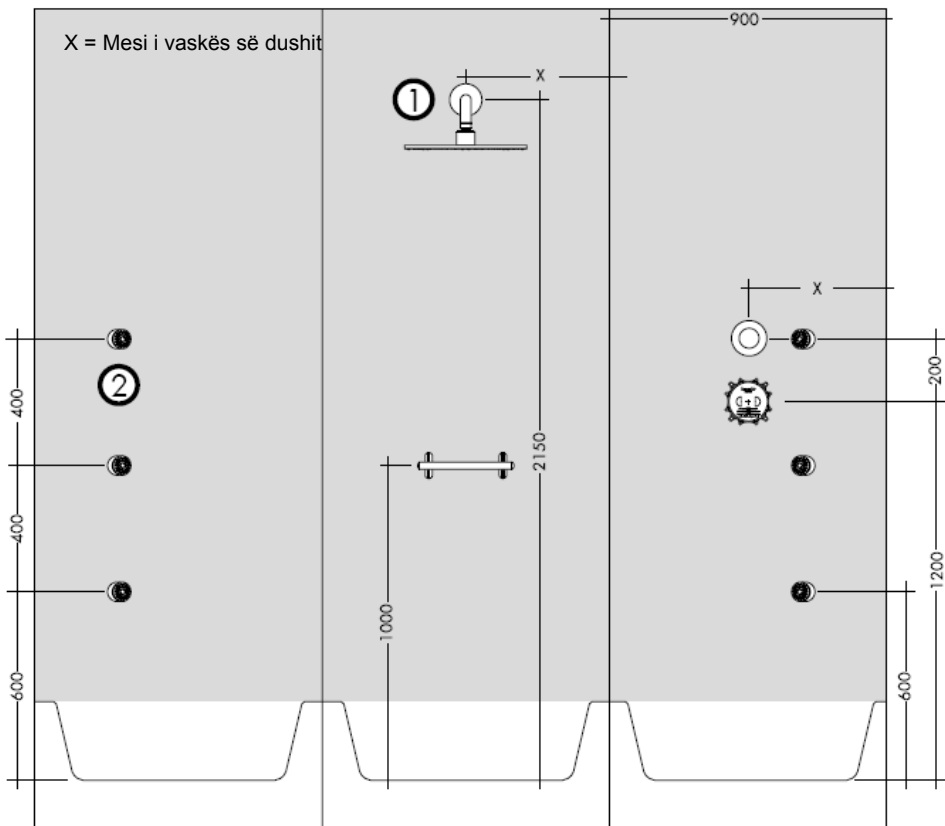

Nevojitet përforcuesi për mur për mbërthimin e krahut të spërkatësit

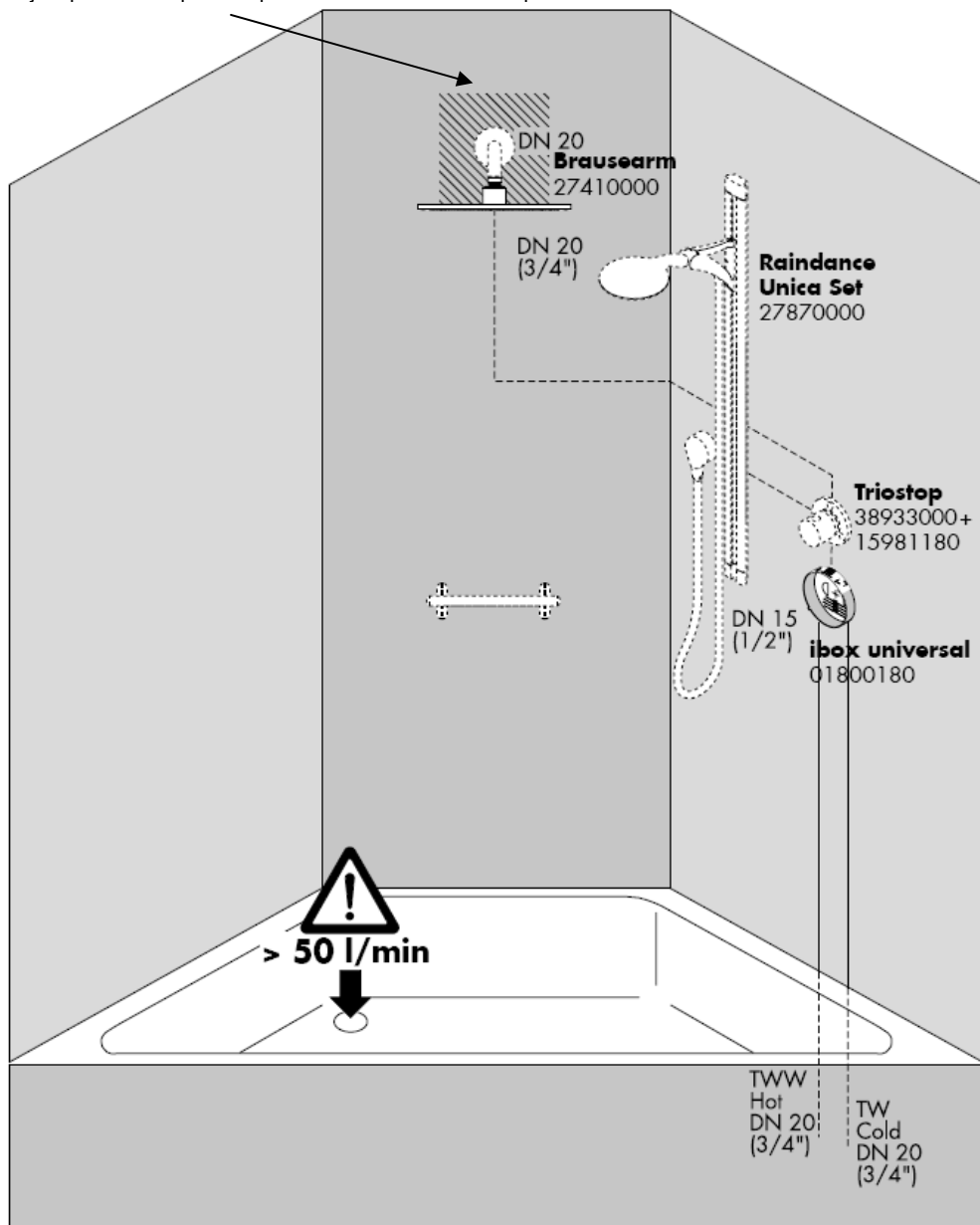

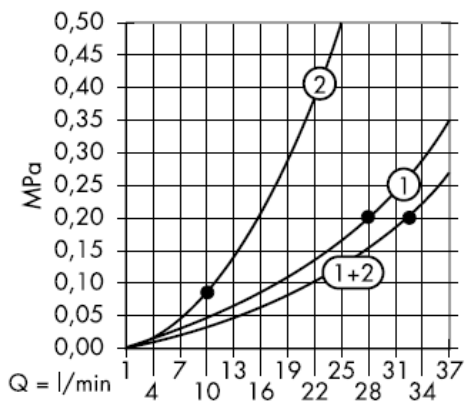

Nga • është i mundur funksioni.

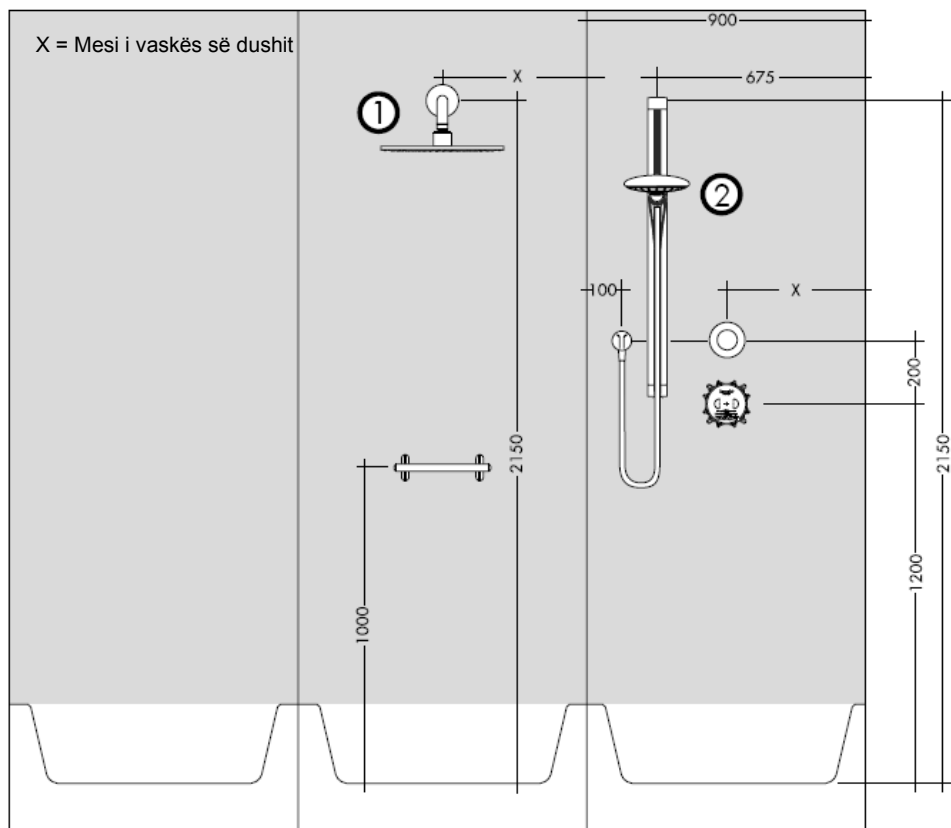

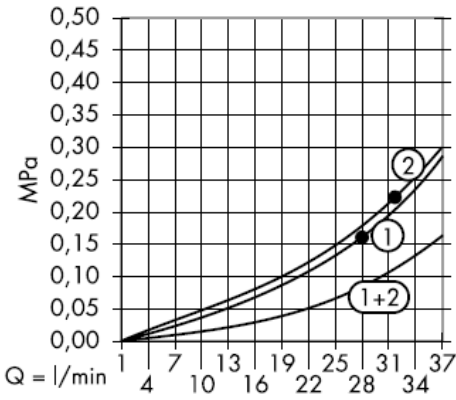

Nga • është i mundur funksioni.

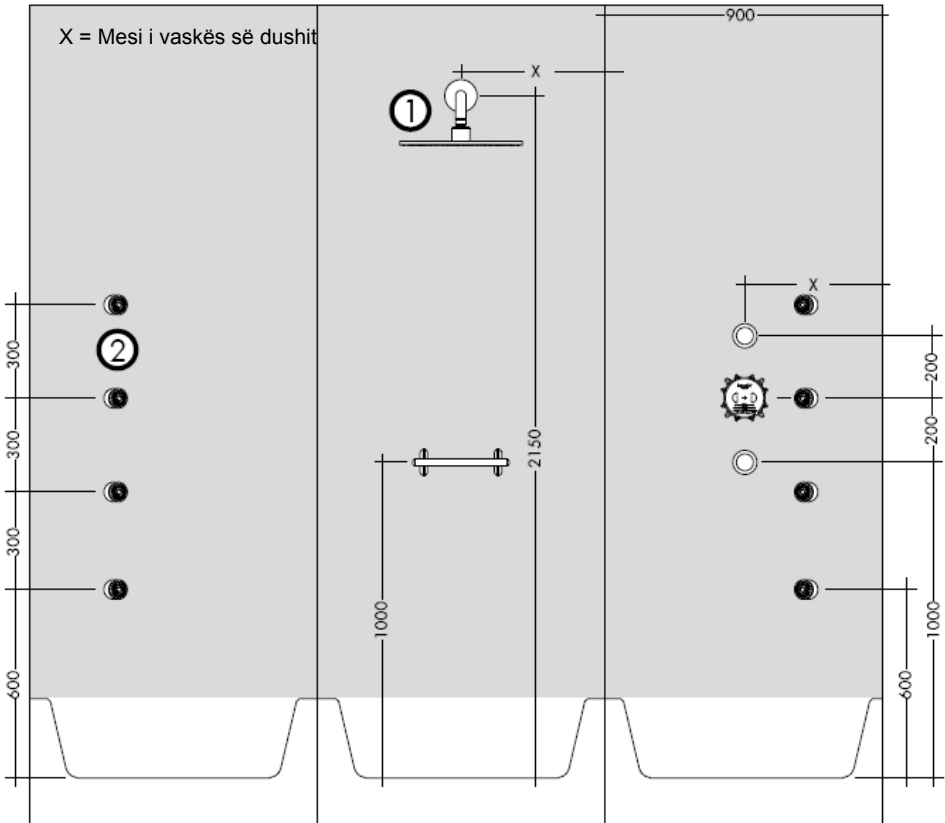

Nevojitet përforcuesi për mur për mbërthimin e krahut të spërkatësit

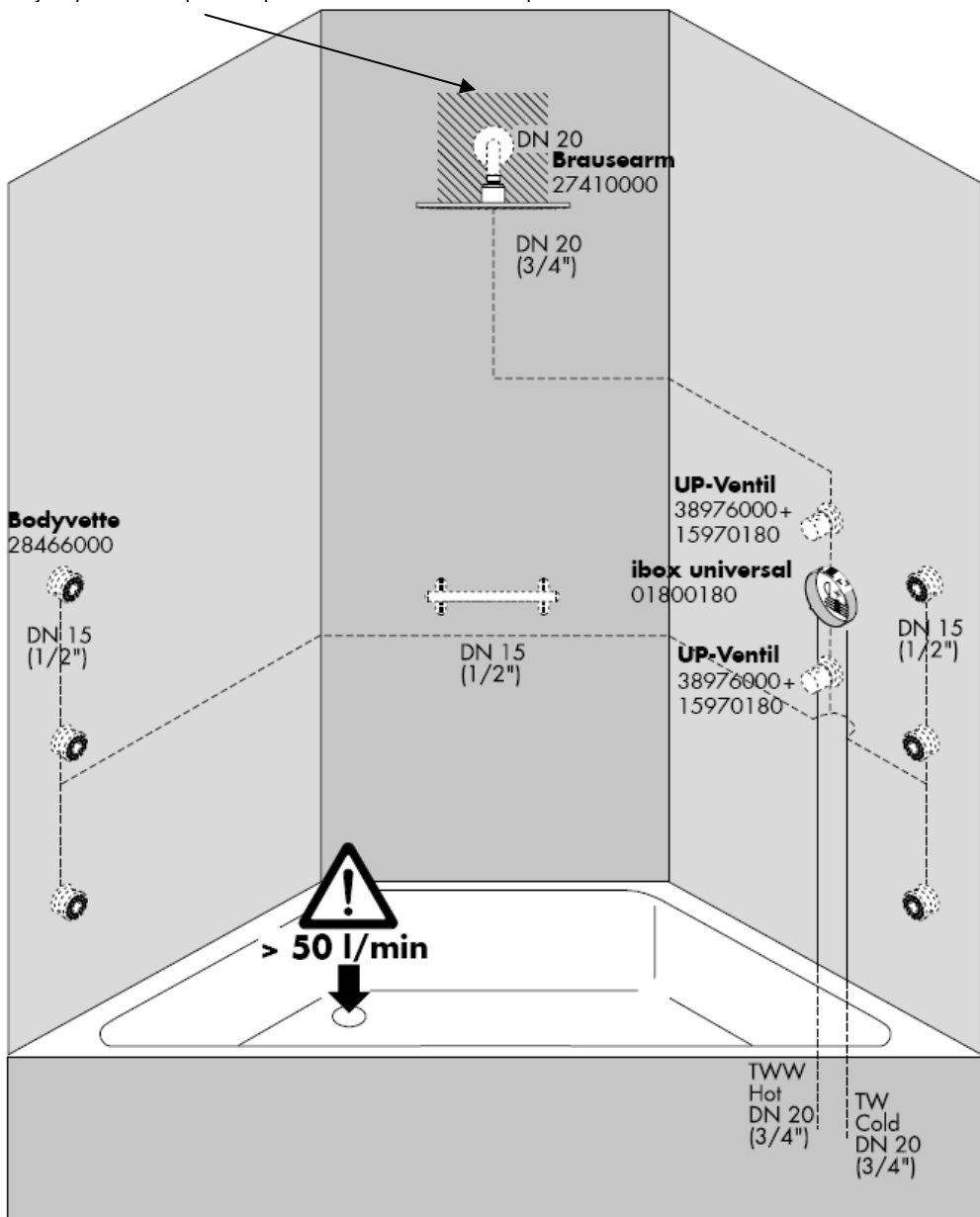

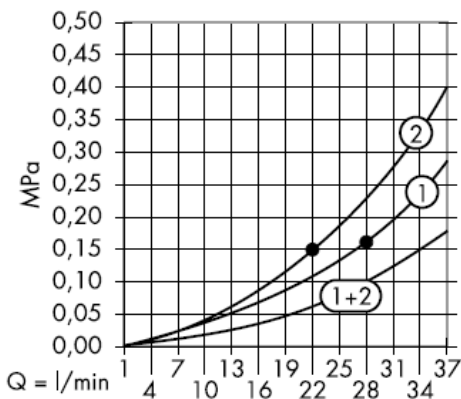

Nga • është i mundur funksioni.

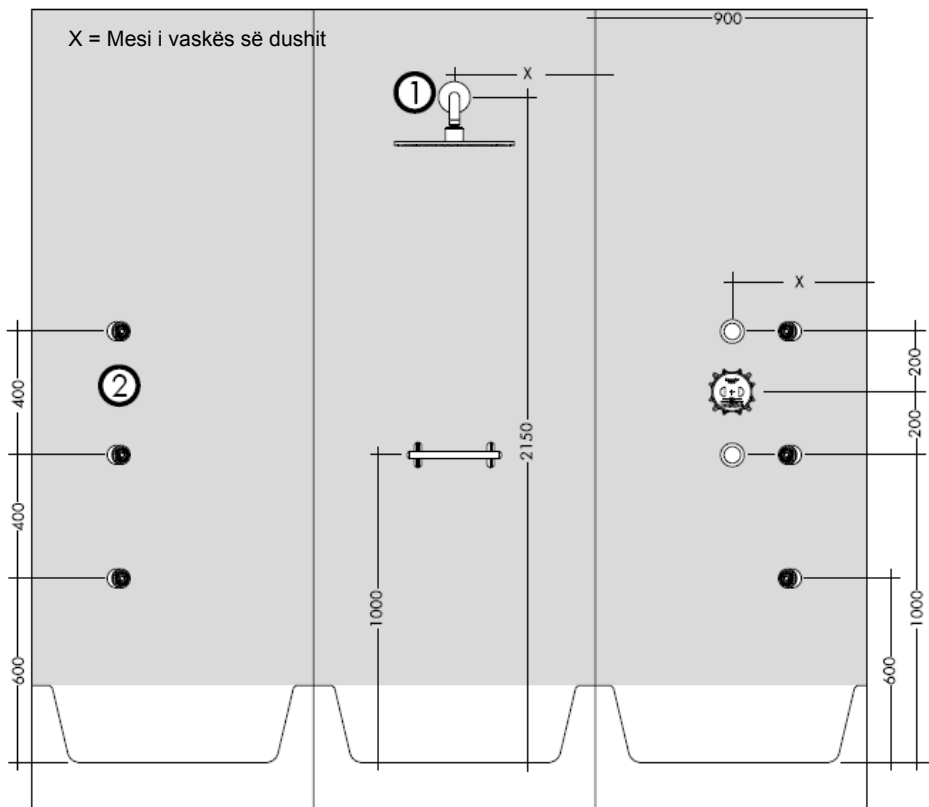

Nevojitet përforcuesi për mur për mbërthimin e krahut të spërkatësit

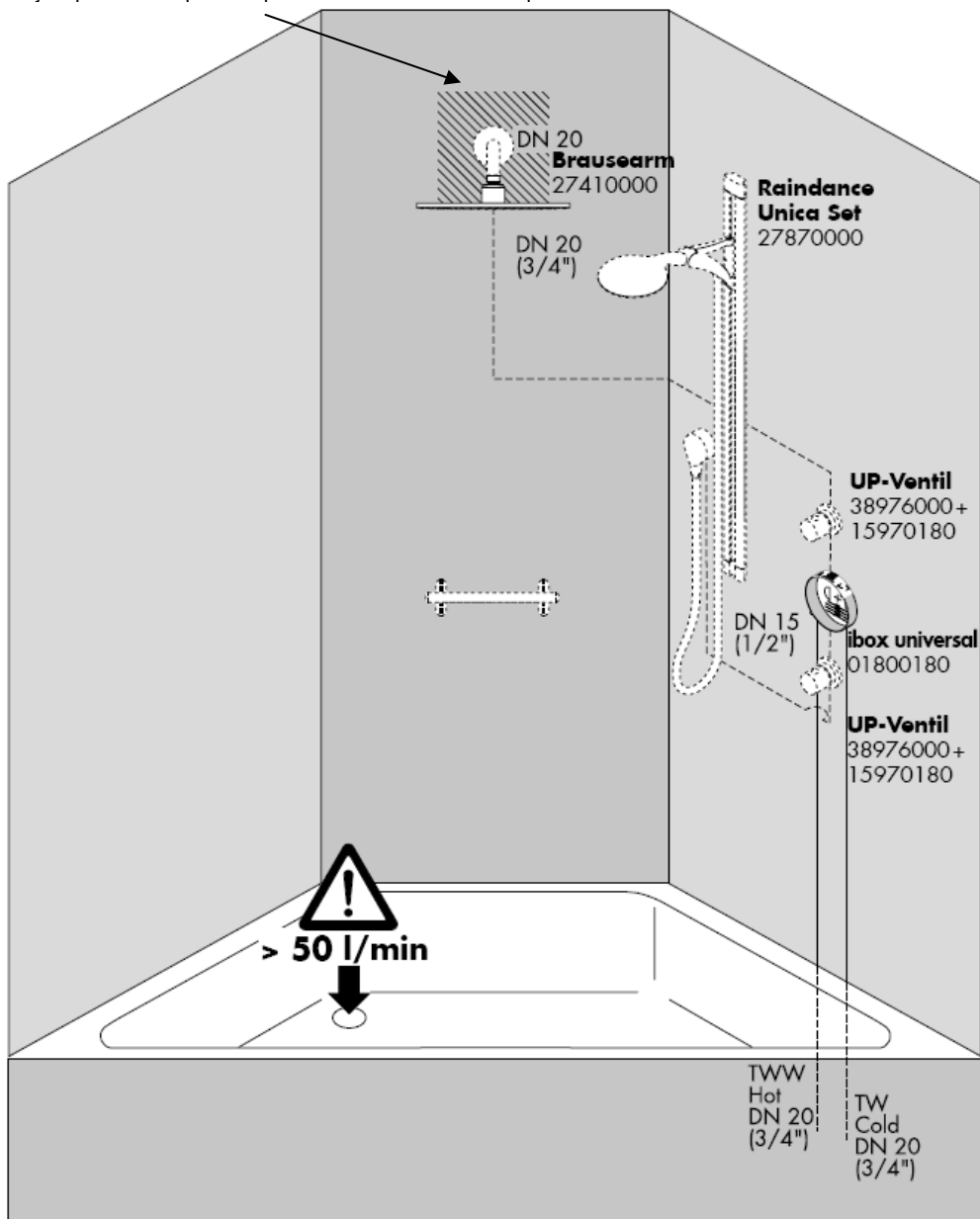

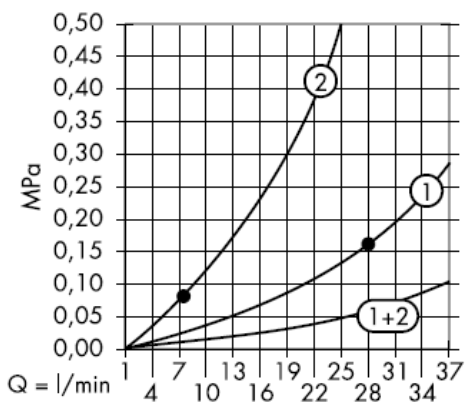

Nga • është i mundur funksioni.

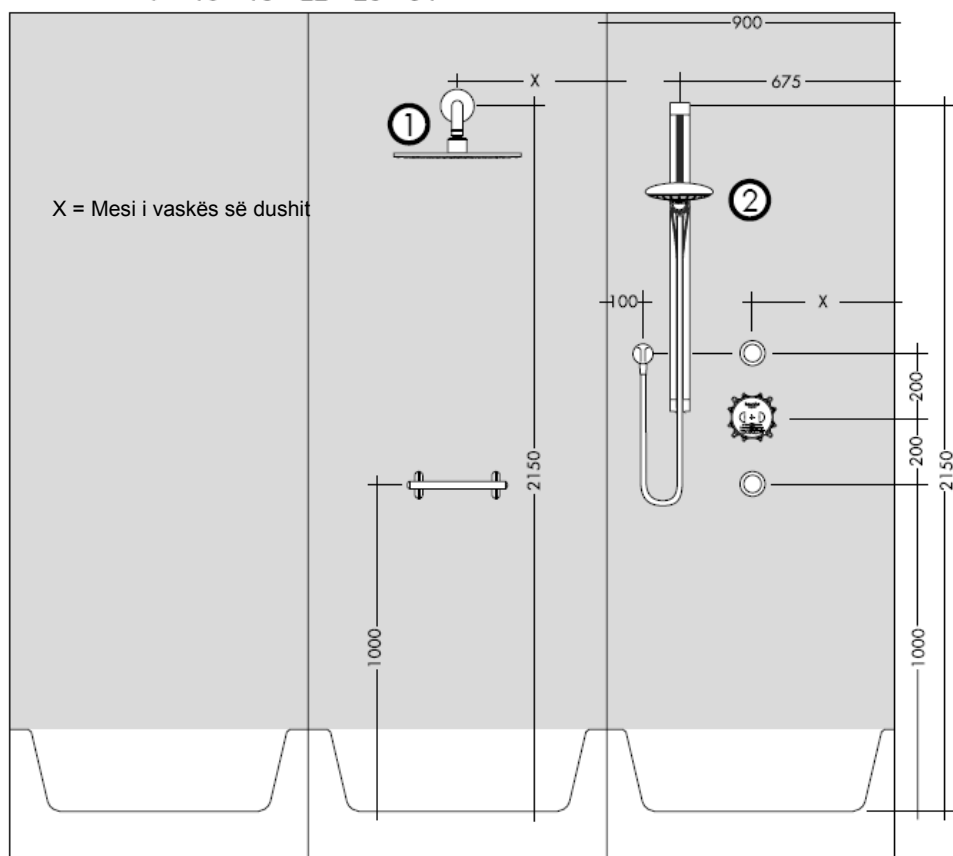

Nevojitet përforcuesi për mur për mbërthimin e krahut të spërkatësit

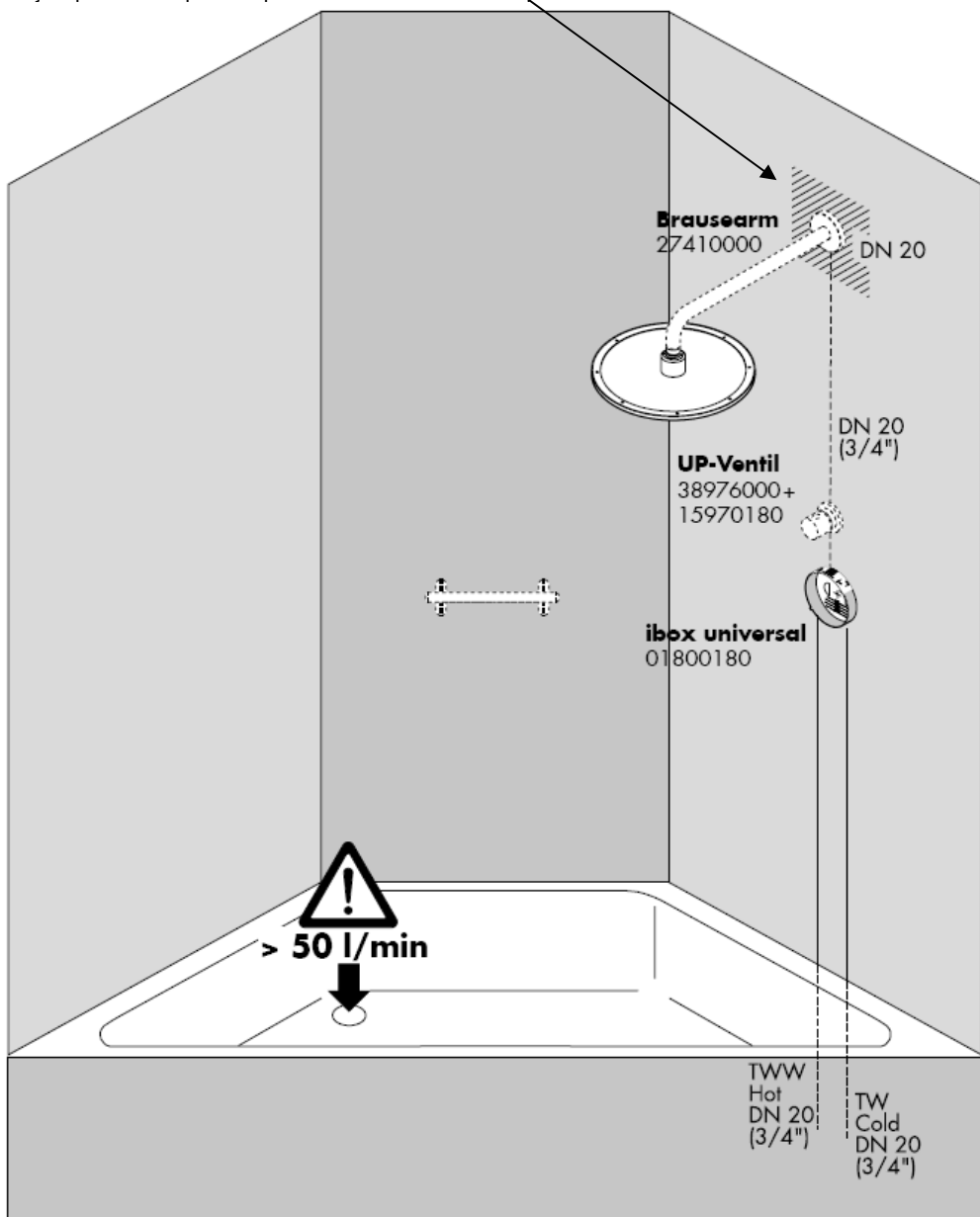

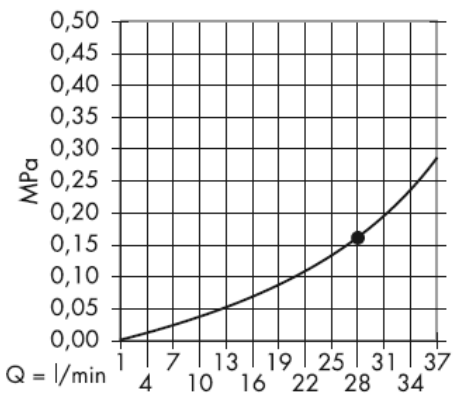

Nga • është i mundur funksioni.

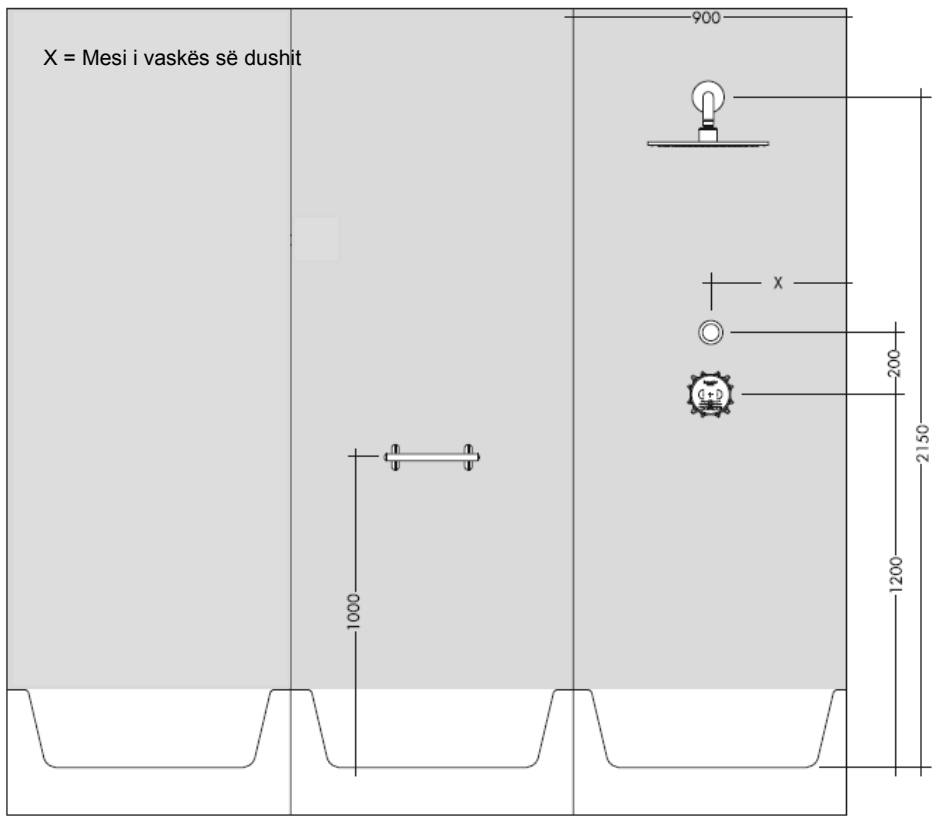

Nevojitet përforcuesi për mur për mbërthimin e krahut të spërkatësit

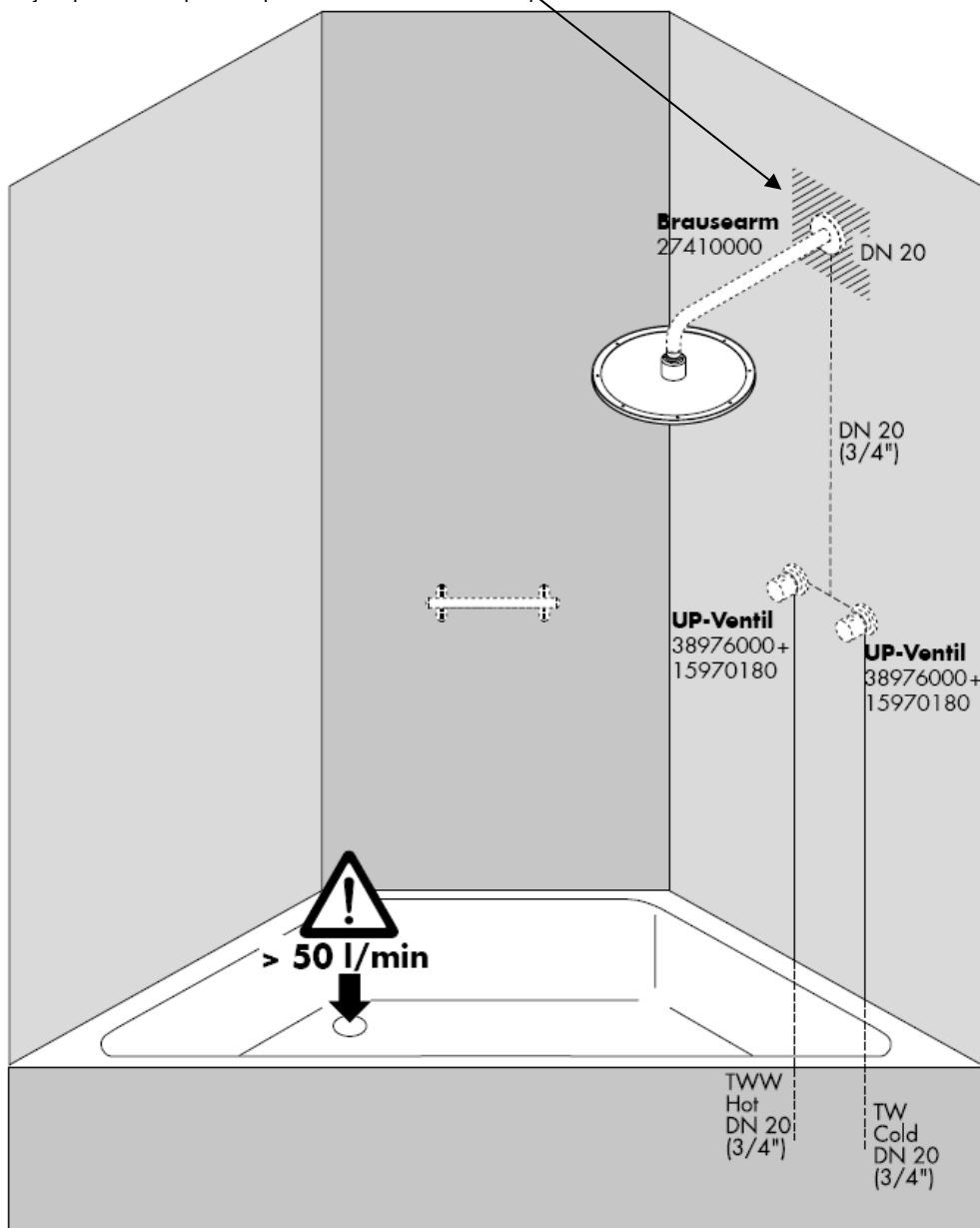

Nga • është i mundur funksioni.

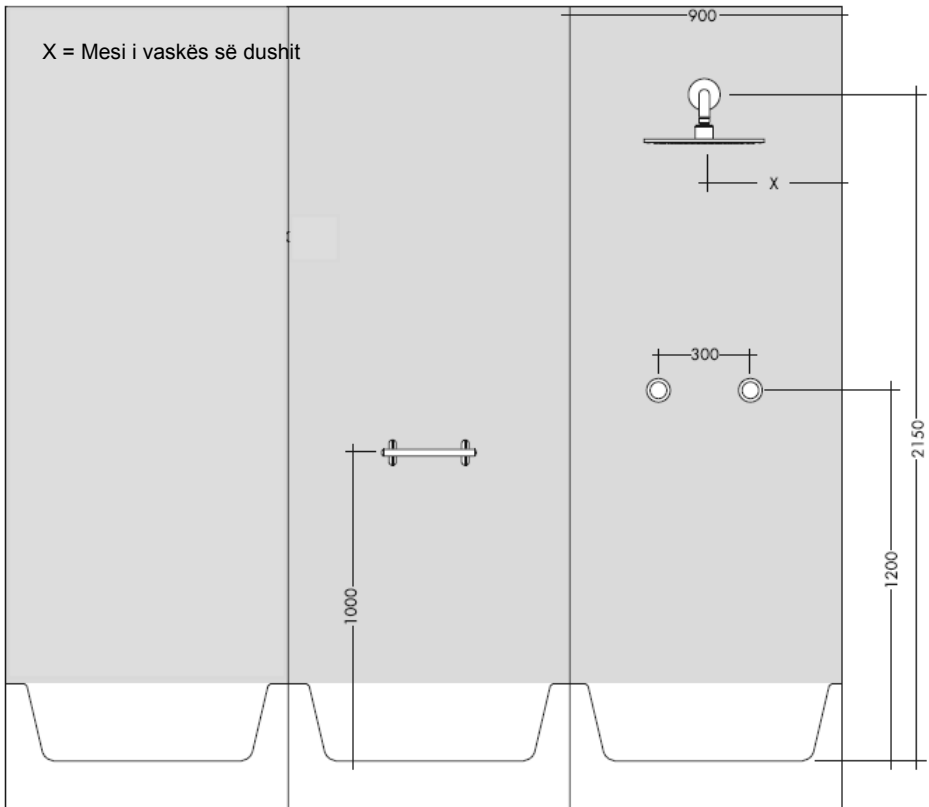
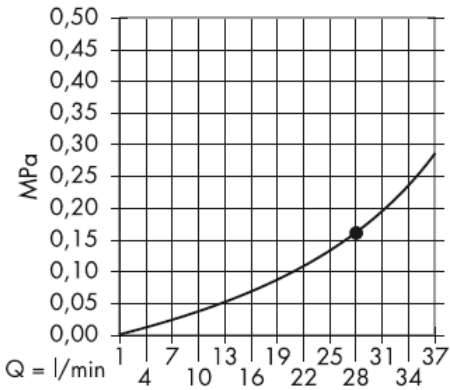

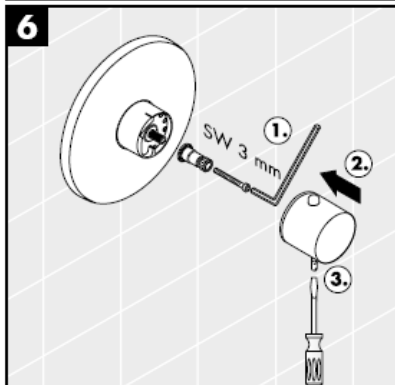
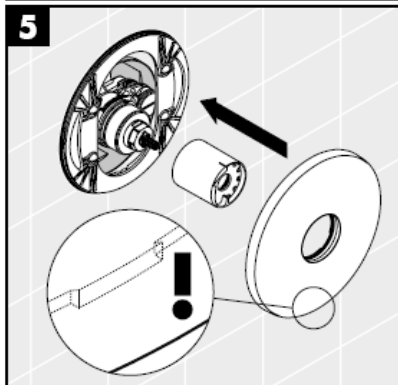
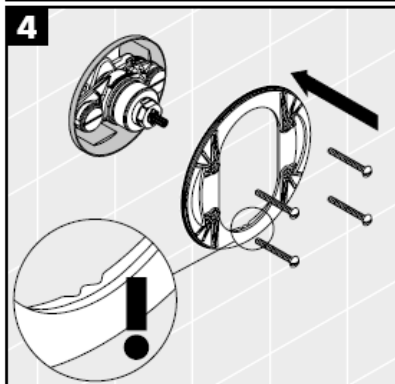
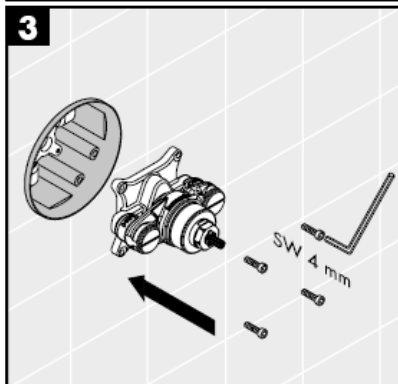
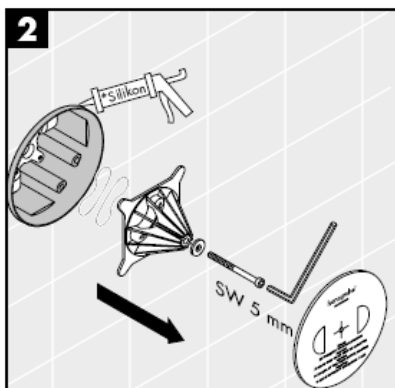
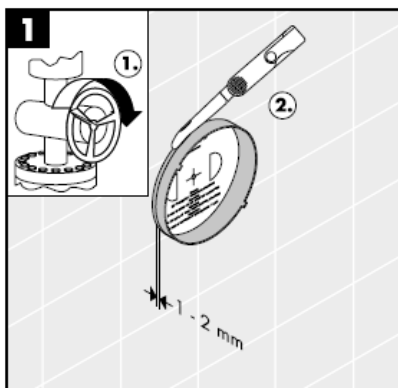

Silikon (pa acid uthulle!)

Falë Safety Function mund të përcaktohet temperatura maksimale e dëshiruar, p.sh. 42 C.

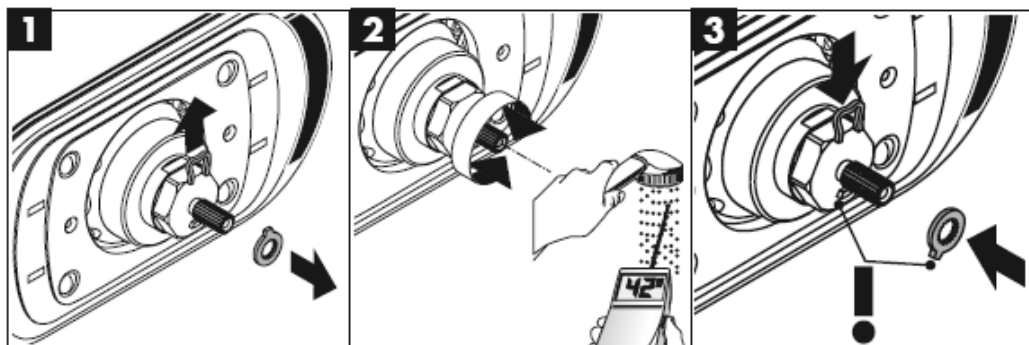

Justimi

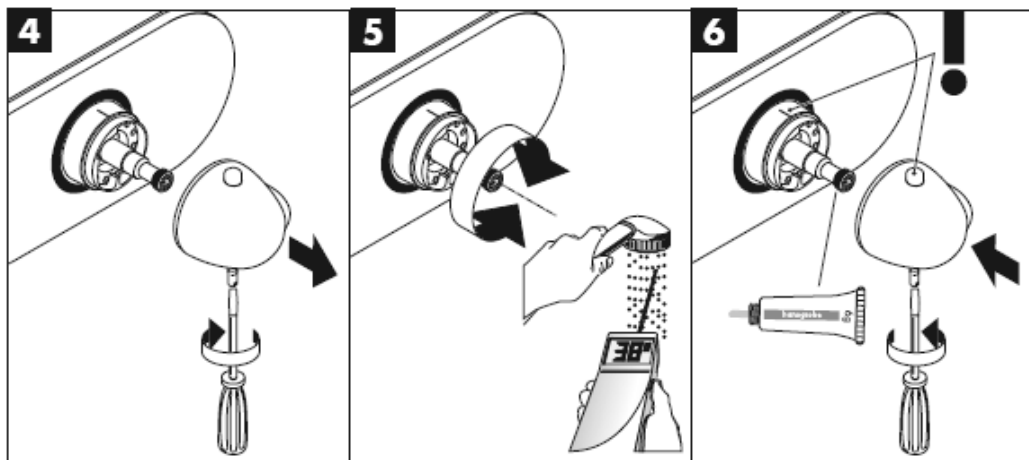



Nëse spërkatësja është në funksion, atëherë ajo së bashku me krahun e spërkatëses peshon 10 kg. Mund të përdoret vetëm material i përshtatshëm për montimin në mure! Vidat dhe dadot e bashkëngjitura janë vetëm për mure masive.

Mund të përdoret vetëm material i përshtatshëm për montimin në mure! Vidat dhe dadot e bashkëngjitura janë vetëm për mure masive.

Kapaciteti i rrjedhjes duhet dimensionuar në mënyrë të mjaftueshme.

Funksionimi optimal garantohe vetëm në kombinim me termostatet High Flow të Hansgrohe.

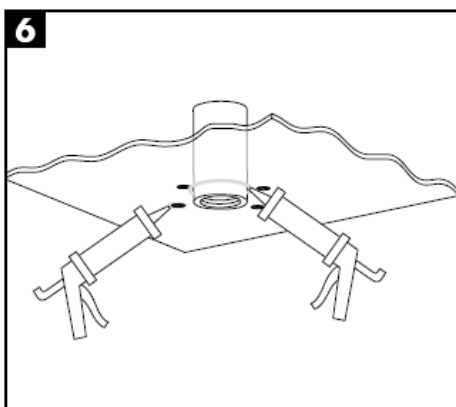
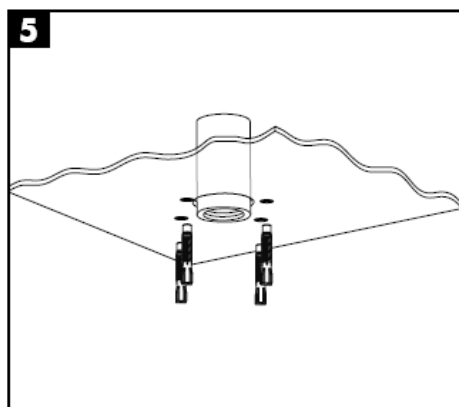
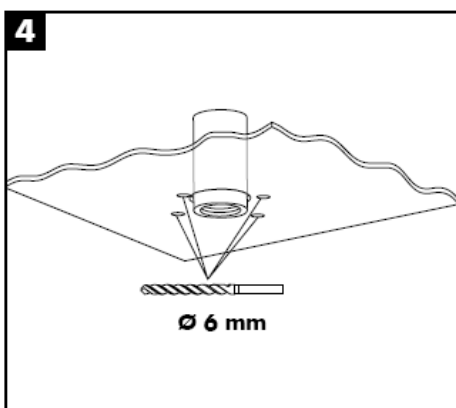
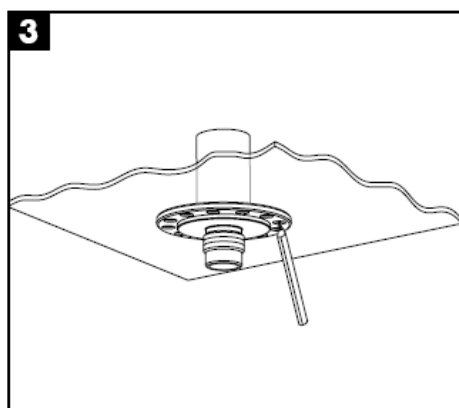
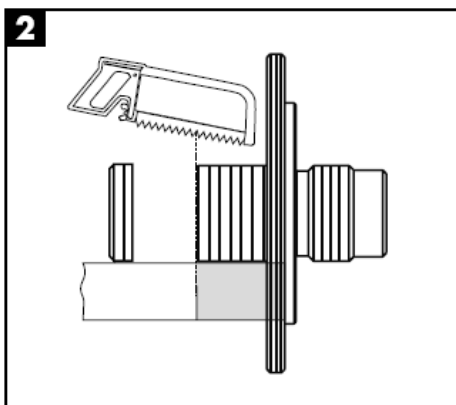
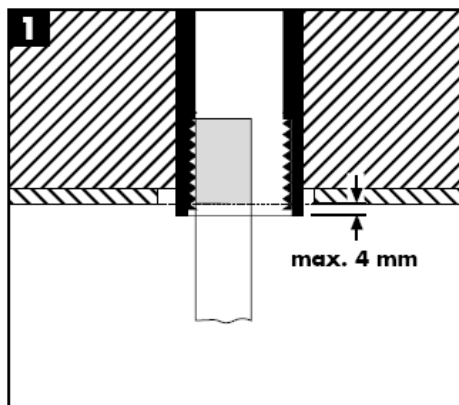

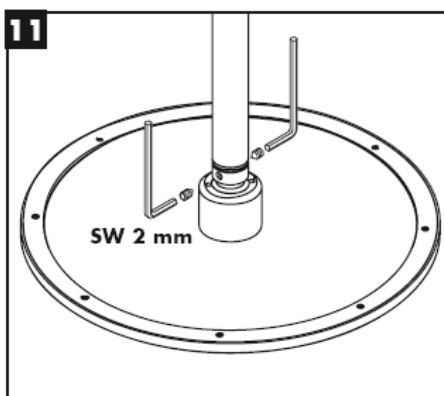
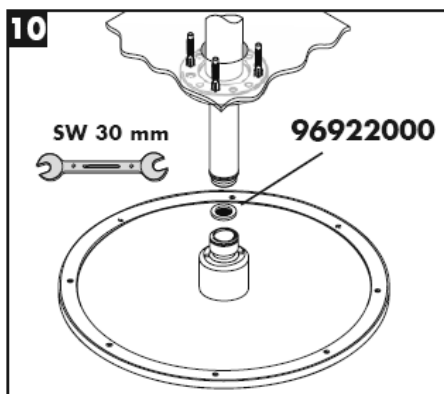
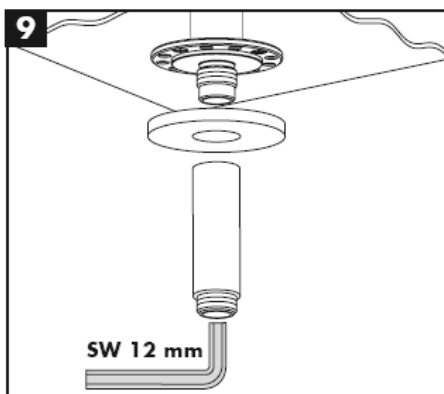
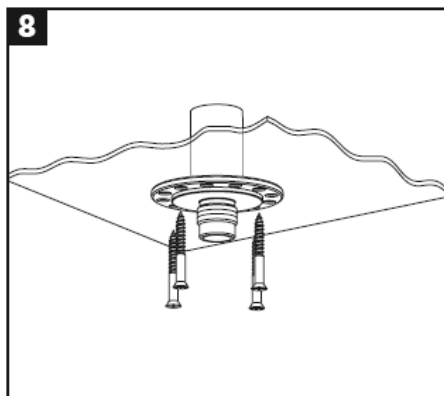
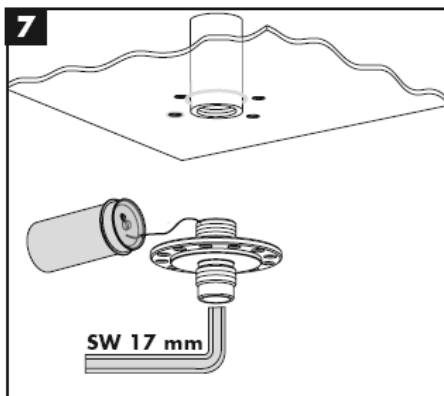

Sita që i kemi bashkëngjitur spërkatëses duhet përdorur për të evituar thithjen e papastërtive nga rrjeti i ujës jellësit. Ndotjet mund të dëmtojnë pjesë funksionale të spërkatëses. Hansgrohe nuk merr përgjegjësinë për dëmet e shkaktuara në këtë mënyrë.

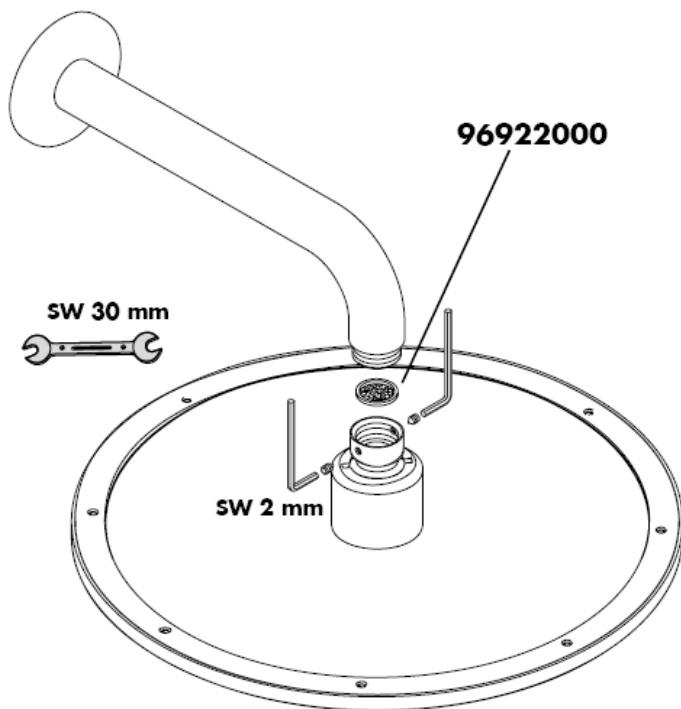

Montimi

Kujdes! Armatura duhet montuar, shpërlarë dhe kontrolluar në bazë të normave të vlefshme!

Justimi

Korrigjimet janë të nevojshme, nëse temperatura e matur në pikën e rrjedhjes së ujit nuk është e njëjtë me temperaturën e përcaktuar në termostat. Gjatë kësaj duhet pasur parasysh: Rrotulloni dorezën e shkallëzimeve deri sa në pikën e rrjedhjes të rrjedhë ujë me temperaturë 38 C. Lironi vidhën e dorezës, tërhiqeni dorezën dhe çojeni në pozicionin 38 C. Vendoseni përsëri dorezën në vend dhe shtërngoni vidhën (shih faqen 22).

Kufizimi i temperaturës

Zona e temperaturës kufizohet me anë të bllokadës së sigurisë në 38 C (ruajta nga përvëlimi).

Nëse dëshironi të keni një temperaturë më të lartë, atëherë mund të kalohet kufiri i caktuar prej 38 C duke shtypur butonin e sigurisë.

Funksionet e sigurisë

Falë Safety Function mund të përcaktohet temperatura maksimale e dëshiruar, p.sh. 42 C. shih faqen 21.

Të dhëna teknike

Presioni gjatë punës max. 1 MPa
 Presioni i rekomanduar: 0,1 – 0,5 MPa
 Presioni i rekomanduar: 1,6 MPa
 (1 MPa = 10 bar = 147 PSI)
 Temperatura e ujit të ngrohtë max.80° C
 Temperatura e rekomanduar e ujit të ngrohtë:65° C
 Kapaciteti i rrjedhjes: ca.58 l/min 0,3 MPa

Mirëmbajtja

Termostatet nuk kanë nevojë për mirëmbajtje të posaçme. Penguesit e rrjedhjes në drejtim të kundërt duhen kontrolluar rregullisht në bazë të normave DIN EN 1717 konform normave nacionale dhe regjionale (DIN 1988 një herë në vit). Kontrolloni me këtë rast edhe mbledhësit e papastërtive të cilët ndodhen në njësinë rregulluese MTC (6.1). Pas montimit të njësisë rregulluese MTC kontrolloni patjetër temperaturën në dalje, siç e kemi përshkruar në pikën "justimi". Para kësaj kontrolloni patjetër se a është i ndezur furnizimi me ujë të ngrohtë dhe a është caktuar temperatura maksimale në pikën nga del uji i ngrohtë.

Për të lehtësuar përdorimin e njësisë rregulluese, termostati do të duhej çuar herë pas here nga shumë i ngrohtë në shumë të ftohtë.

Pjesët e servisit shih faqen 3

1	Doreza e termostatit	38391000
2	Rozeta	96452000
3	Gëzhoja	97439000
4	Vidhat e mbajtëses	96454000
5	Rozeta e mbajtëses	96447000
6	Njësia rregulluese e temperaturës	96633000
7	Sitë për mbledhjen e papastërtive	97367000
8	Penguesi i rrjedhjes në drejtim të kundërt	96655000
9	Zgjatësi 25 mm	13595000
10	Zgjatësi 25 mm	13596000

Shqib

Demtim	Shkaku	Ndihme
Pak ujë	-Presioni ushqyes jo limjaftueshem -Sita qe mbledh papastertite tek njesia rregulluese eshte me papasterti -Gomina hermetizuese e pajisjes me papasterti	-Kontrolloni presionin e tubacionit -Pastroni siten qe mbledh papastertite -Pastroni gominen e sites midis pajisjes dhe tubit
Rrjedhje e kryqezuar, uji i ngrothe do te cohet tek tubacioni i ujit te ftohte kur armatura eshte e mbyllur ose anasjelltas	-Penguesi i rrjedhjes mbrapsht te ujit me papasterti ose me defekt	-Kembeni penguesin e rrjedhjes mbrapsht te ujit
Temperatura reale nuk perputhet me temperaturen e regjistruar	-Termostati nuk eshte rregulluar -Temperaturë e ulët e ujit të ngrorhtë	-Rregulloni termostatin -Rrisni temperaturen e ujit te ngrothe nga 42 C deri 65 C
Rregullimi i temperatures nuk eshte i mundur	-Njesia rregulluese e temperatures me papasterti ose me kalk -Montoni bllokun e funksioneve ne 180 grade mbrapsht	-Tek instalimi i ri karkasa baze eshte lidhur gabim(Duhet: ftohte djathtas, ngrothe majtas) ose eshte montuar 180grade ndryshe -Butoni i bllokuesit te sigurise pa funksion
Susta me defekt	-Pastroni butonin ose susten dhe grasatojeni pak, ose nderrojeni -Butoni me kalk	-Pastroni butonin ose susten dhe grasatojeni pak, ose nderrojeni -Pastroni butonin ose susten dhe grasatojeni pak, ose nderrojeni

Shenja e kontrollit

	P-IX	DVGW	SVGW	WRSA	KIWA	ACS	NF
27070000						X	
27418XXX							
28420000						X	
28435XXX						X	

Pastrimi

Thjesht dhe pastër. Mbetjet gëlqerore mund të hiqen me fërkim të lehtë.

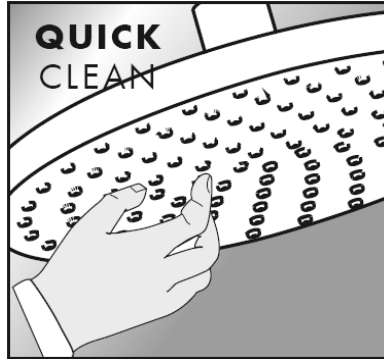

Udhëzime rreth mirëmbajtjes

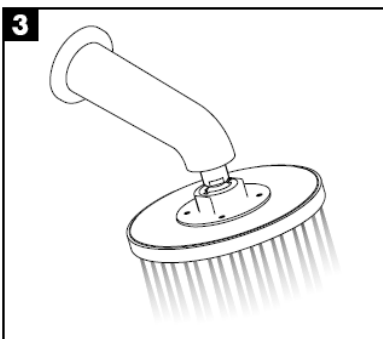
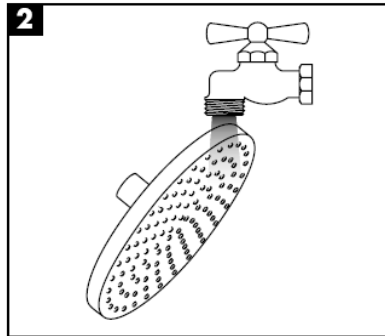
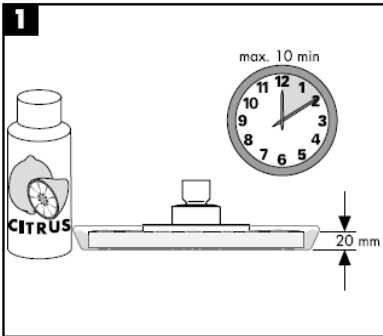

hansgrohe